

GNU Image Manipulation Program

User Manual

November 17, 2021

GNU Image Manipulation Program

Copyright © 2002-2021 The GIMP Documentation Team

Legal Notice

Permission is granted to copy, distribute and/or modify this document under the terms of the GNU Free Documentation License, Version 1.2 or any later version published by the Free Software Foundation; with no Invariant Sections, no Front-Cover Texts, and no Back-Cover Texts. A copy of the license is included in the section enphrased [GNU Free Documentation License](#).

Contents

I	Getting Started	1
1	Introduction	3
1.1	Welcome to GIMP	3
1.1.1	Authors	3
1.1.2	The GIMP Help system	3
1.1.3	Features and Capabilities	3
1.2	What's new in GIMP 2.10.18?	4
2	Fire up GIMP	5
2.1	Running GIMP	5
2.1.1	Known Platforms	5
2.1.2	Language	5
2.1.3	Command Line Arguments	6
2.2	Starting GIMP the first time	7
2.2.1	Finally	7
3	First Steps with Wilber	9
3.1	Basic Concepts	9
3.2	Main Windows	11
3.2.1	The Toolbox	14
3.2.2	Image Window	16
3.2.3	Dialogs and Docking	19
3.3	Undoing	25
3.3.1	Things That Cannot be Undone	25
3.4	Common Tasks	26
3.4.1	Intention	26
3.4.2	Change the Size of an Image for the screen	26
3.4.3	Change the Size of an Image for print	28
3.4.4	Compressing Images	29
3.4.5	Crop An Image	32
3.4.6	Find Info About Your Image	33
3.4.7	Change the Mode	34
3.4.8	Flip An Image	36
3.4.9	Rotate An Image	38
3.4.10	Separating an Object From Its Background	39
3.5	How to Draw Straight Lines	40
3.5.1	Intention	41
3.5.2	Examples	44
4	Getting Unstuck	47
4.1	Getting Unstuck	47
4.1.1	Stuck!	47
4.1.2	Common Causes of GIMP Non-Responsiveness	47
II	How do I Become a GIMP Wizard?	51
5	Getting Images into GIMP	53
5.1	Image Types	53
5.2	Creating new Files	55
5.3	Opening Files	55
5.3.1	Open File	55

5.3.2	Open Location	57
5.3.3	Open Recent	58
5.3.4	Using External Programs	58
5.3.5	File Manager	58
5.3.6	Drag and Drop	58
5.3.7	Copy and Paste	58
5.3.8	Image Browser	58
6	Getting Images out of GIMP	59
6.1	Files	59
6.1.1	Save / Export Images	59
6.1.2	File Formats	59
6.2	Preparing your Images for the Web	67
6.2.1	Images with an Optimal Size/Quality Ratio	67
6.2.2	Reducing the File Size Even More	68
6.2.3	Saving Images with Transparency	69
7	Painting with GIMP	71
7.1	The Selection	71
7.1.1	Feathering	72
7.1.2	Making a Selection Partially Transparent	73
7.2	Creating and Using Selections	73
7.2.1	Moving a Selection	73
7.2.2	Adding or subtracting selections	75
7.3	The QuickMask	75
7.3.1	Overview	76
7.3.2	Properties	76
7.4	Using QuickMask Mode	77
7.5	Paths	77
7.5.1	Path Creation	77
7.5.2	Path Properties	78
7.5.3	Paths and Selections	79
7.5.4	Transforming Paths	79
7.5.5	Stroking a Path	79
7.5.6	Paths and Text	80
7.5.7	Paths and SVG files	80
7.6	Brushes	81
7.7	Adding New Brushes	83
7.8	The GIH Dialog Box	84
7.9	Changing brush size	88
7.9.1	How to change the size of a brush	88
7.9.2	Creating a brush quickly	90
7.10	Gradients	91
7.11	Patterns	93
7.12	Palettes	95
7.12.1	Colormap	96
7.13	Presets	97
7.14	Drawing Simple Objects	97
7.14.1	Drawing a Straight Line	97
7.14.2	Creating a Basic Shape	99
8	Combining Images	101
8.1	Introduction to Layers	101
8.1.1	Layer Properties	101
8.2	Layer Modes	105
8.3	Creating New Layers	118
8.4	Layer Groups	119

9	Text Management	123
9.1	Text Management	123
9.1.1	Text Area	123
9.1.2	Managing Text Layer	124
9.1.3	Text Toolbox	125
9.1.4	Text Context Menu	126
9.2	Text	128
9.2.1	Embellishing Text	128
9.2.2	Adding Fonts	128
9.2.3	Font Problems	130
10	Enhancing Photographs	131
10.1	Working with Digital Camera Photos	131
10.1.1	Introduction	131
10.1.2	Improving Composition	131
10.1.3	Improving Colors	132
10.1.4	Adjusting Sharpness	134
10.1.5	Removing Unwanted Objects from an Image	135
10.1.6	Saving Your Results	136
11	Color Management with GIMP	139
11.1	Color Management in GIMP	139
11.1.1	Problems of a non Color Managed Workflow	139
11.1.2	Introduction to a Color Managed Workflow	140
12	Enrich my GIMP	143
12.1	Preferences Dialog	143
12.1.1	Introduction	143
12.1.2	System Resources	144
12.1.3	Color Management	145
12.1.4	Image Import and Export	148
12.1.5	Tool Options	149
12.1.6	Default Image Preferences	150
12.1.7	Default Image Grid	151
12.1.8	Interface	152
12.1.9	Theme	153
12.1.10	Icon Theme	153
12.1.11	Toolbox	154
12.1.12	Dialog Defaults	155
12.1.13	Help System	156
12.1.14	Display	157
12.1.15	Window Management	158
12.1.16	Image Windows	160
12.1.17	Image Window Appearance	161
12.1.18	Image Window Title and Statusbar	163
12.1.19	Image Window Snapping Behavior	164
12.1.20	Input Devices	164
12.1.21	Input Controllers	165
12.1.22	Folders	168
12.1.23	Data Folders	169
12.2	Grids and Guides	169
12.2.1	The Image Grid	170
12.2.2	Guides	171
12.3	Rendering a Grid	172
12.4	How to Set Your Tile Cache	172
12.5	Creating Shortcuts to Menu Functions	173
12.6	Customize Splash-Screen	175

13 Scripting	177
13.1 Plugins	177
13.1.1 Introduction	177
13.1.2 Using Plugins	178
13.1.3 Installing New Plugins	178
13.1.4 Writing Plugins	179
13.2 Using Script-Fu Scripts	180
13.2.1 Script-Fu?	180
13.2.2 Installing Script-Fus	180
13.2.3 Do's and Don'ts	180
13.2.4 Different Kinds Of Script-Fus	180
13.2.5 Standalone Scripts	182
13.2.6 Image-Dependent Scripts	183
13.3 A Script-Fu Tutorial	183
13.3.1 Getting Acquainted With Scheme	183
13.3.2 Variables And Functions	185
13.3.3 Lists, Lists And More Lists	187
13.3.4 Your First Script-Fu Script	190
13.3.5 Giving Our Script Some Guts	196
13.3.6 Extending The Text Box Script	198
13.3.7 Your script and its working	200
III Function Reference	203
14 Tools	205
14.1 The Toolbox	205
14.1.1 Introduction	205
14.1.2 Tool Icons	205
14.1.3 Color and Indicator Area	206
14.1.4 Tool Options	208
14.2 Selection Tools	210
14.2.1 Common Features	210
14.2.2 Rectangle Selection	212
14.2.3 Ellipse Selection	216
14.2.4 Free Selection (Lasso)	219
14.2.5 Fuzzy selection (Magic wand)	221
14.2.6 Select By Color	224
14.2.7 Intelligent Scissors	226
14.2.8 Foreground Select	228
14.3 Paint Tools	233
14.3.1 Common Features	233
14.3.2 Dynamics	241
14.3.3 Brush Tools (Pencil, Paintbrush, Airbrush)	249
14.3.4 Bucket Fill	249
14.3.5 Gradient	253
14.3.6 Pencil	260
14.3.7 Paintbrush	261
14.3.8 MyPaint Brush	263
14.3.9 Eraser	266
14.3.10 Airbrush	268
14.3.11 Ink	270
14.3.12 Clone	271
14.3.13 Heal	276
14.3.14 Perspective Clone	278
14.3.15 Blur/Sharpen	280
14.3.16 Smudge	283
14.3.17 Dodge/Burn	287
14.4 Transform Tools	289

14.4.1	Common Features	289
14.4.2	Align	295
14.4.3	Move	301
14.4.4	Crop	303
14.4.5	Rotate	306
14.4.6	Scale	308
14.4.7	Shear	310
14.4.8	Perspective	312
14.4.9	3D Transform	314
14.4.10	Unified Transform	315
14.4.11	Handle Transform	320
14.4.12	Flip	324
14.4.13	The Cage Tool	325
14.4.14	Warp Transform	327
14.5	Other	330
14.5.1	Overview	330
14.5.2	Paths	331
14.5.3	Color Picker	334
14.5.4	Zoom	336
14.5.5	Measure	337
14.5.6	Text	340
14.5.7	GEGL Operation	345
15	Dialogs	347
15.1	Dialog Introduction	347
15.2	Image Structure Related Dialogs	347
15.2.1	Layers Dialog	347
15.2.2	Channels Dialog	352
15.2.3	Paths Dialog	358
15.2.4	Colormap Dialog	362
15.2.5	Histogram dialog	364
15.2.6	Navigation Dialog	367
15.2.7	Undo History Dialog	368
15.3	Image-content Related Dialogs	370
15.3.1	FG/BG Color Dialog	370
15.3.2	Brushes Dialog	373
15.3.3	Patterns Dialog	378
15.3.4	Gradients Dialog	380
15.3.5	Palettes Dialog	388
15.3.6	Tagging	394
15.3.7	Fonts Dialog	395
15.4	Image Management Related Dialogs	397
15.4.1	Buffers Dialog	397
15.4.2	Images Dialog	399
15.4.3	Document History Dialog	400
15.4.4	Templates Dialog	401
15.5	Miscellaneous Dialogs	404
15.5.1	Tool Presets Dialog	404
15.5.2	Tool Preset Editor	406
15.5.3	Device Status Dialog	407
15.5.4	Error Console	407
15.5.5	Dashboard	409
15.5.6	Save File	409
15.5.7	Export File	410
15.5.8	Sample Points Dialog	412
15.5.9	Pointer Dialog	413
15.5.10	Symmetry Painting dialog	414

16 Menus	419
16.1 Introduction to Menus	419
16.1.1 The Image Menu Bar	419
16.1.2 Context Menus	419
16.1.3 Tear-off menus	419
16.1.4 Tab menus	420
16.2 The “File” Menu	421
16.2.1 Overview	421
16.2.2 New...	421
16.2.3 Create	426
16.2.4 Open...	428
16.2.5 Open as Layers...	429
16.2.6 Open Location...	429
16.2.7 Open Recent	430
16.2.8 Save	430
16.2.9 Save as...	430
16.2.10 Save a Copy...	432
16.2.11 Revert	432
16.2.12 Export...	432
16.2.13 Export As...	433
16.2.14 Create Template...	433
16.2.15 Print	434
16.2.16 Send by Email	434
16.2.17 Copy Image Location	434
16.2.18 Show in File Manager	434
16.2.19 Close	434
16.2.20 Close all	435
16.2.21 Quit	435
16.3 The “Edit” Menu	436
16.3.1 “Edit” Menu Entries	436
16.3.2 Undo	436
16.3.3 Redo	437
16.3.4 Undo History	437
16.3.5 Cut	437
16.3.6 Copy	438
16.3.7 Copy Visible	438
16.3.8 Paste	438
16.3.9 Paste Into Selection	439
16.3.10 Paste In Place	439
16.3.11 Paste Into Selection In Place	439
16.3.12 Paste as	439
16.3.13 Buffer	441
16.3.14 Clear	442
16.3.15 Fill with FG Color	442
16.3.16 Fill with BG Color	442
16.3.17 Fill with Pattern	443
16.3.18 Fill Selection Outline	443
16.3.19 Fill Path	444
16.3.20 Stroke Selection	444
16.3.21 Stroke Path	445
16.3.22 The “Preferences” Command	447
16.3.23 Keyboard Shortcuts	447
16.3.24 Modules	447
16.3.25 Units	448
16.4 The “Select” Menu	450
16.4.1 Introduction to the “Select” Menu	450
16.4.2 Select All	451
16.4.3 None	451
16.4.4 Invert	451

16.4.5	Float	452
16.4.6	By Color	453
16.4.7	From Path	453
16.4.8	Selection Editor	453
16.4.9	Feather	456
16.4.10	Sharpen	457
16.4.11	Shrink	457
16.4.12	Grow	458
16.4.13	Border	459
16.4.14	Remove Holes	460
16.4.15	Distort	462
16.4.16	Rounded Rectangle	463
16.4.17	Toggle QuickMask	464
16.4.18	Save to Channel	464
16.4.19	To Path	464
16.5	The “View” Menu	465
16.5.1	Introduction to the “View” Menu	465
16.5.2	New View	465
16.5.3	Show All	466
16.5.4	Dot for Dot	467
16.5.5	Zoom	468
16.5.6	Flip and Rotate (0°)	469
16.5.7	Shrink Wrap	470
16.5.8	Full Screen	470
16.5.9	Navigation Window	471
16.5.10	Display Filters	471
16.5.11	Color Management	474
16.5.12	Show Selection	475
16.5.13	Show Layer Boundary	475
16.5.14	Show Guides	475
16.5.15	Show Grid	476
16.5.16	Show Sample Points	476
16.5.17	Snap to Guides	476
16.5.18	Snap to Grid	476
16.5.19	Snap to Canvas	476
16.5.20	Snap to Active Path	477
16.5.21	Padding Color	477
16.5.22	Show Menubar	477
16.5.23	Show Rulers	478
16.5.24	Show Scrollbars	478
16.5.25	Show Statusbar	478
16.6	The “Image” Menu	479
16.6.1	Overview	479
16.6.2	Duplicate	479
16.6.3	<i>Mode</i>	480
16.6.4	RGB mode	480
16.6.5	Grayscale mode	480
16.6.6	Indexed mode	481
16.6.7	<i>Precision</i>	483
16.6.8	<i>Color Management</i>	485
16.6.9	Enable Color Management	486
16.6.10	Assign Color Profile	490
16.6.11	Convert to Color Profile	496
16.6.12	Discard Color Profile	503
16.6.13	Save Color Profile to File	504
16.6.14	<i>Transform</i>	506
16.6.15	Flip Horizontally; Flip Vertically	507
16.6.16	Rotation	507
16.6.17	Canvas Size	507

16.6.18	Fit Canvas to Layers	511
16.6.19	Fit Canvas to Selection	511
16.6.20	Print Size	511
16.6.21	Scale Image	512
16.6.22	Crop Image	514
16.6.23	Slice Using Guides	515
16.6.24	Zealous Crop	515
16.6.25	Merge Visible Layers	516
16.6.26	Flatten Image	517
16.6.27	Align Visible Layers...	517
16.6.28	<i>Guides</i>	521
16.6.29	New Guide	521
16.6.30	New Guide (by Percent)	522
16.6.31	New Guides from Selection	522
16.6.32	Remove all guides	523
16.6.33	Configure Grid...	523
16.6.34	Image Properties	524
16.6.35	<i>Metadata</i>	526
16.6.36	Metadata Viewer	527
16.6.37	Metadata Editor	527
16.7	The “Layer” Menu	528
16.7.1	Introduction to the “Layer” Menu	528
16.7.2	New Layer	529
16.7.3	New Layer Group	533
16.7.4	New From Visible	534
16.7.5	Duplicate layer	534
16.7.6	Anchor layer	534
16.7.7	Merge Down	535
16.7.8	Delete Layer	535
16.7.9	The Text Commands of the Layer Menu	535
16.7.10	Discard Text Information	536
16.7.11	“Stack” Submenu	536
16.7.12	Select Previous Layer	537
16.7.13	Select Next Layer	537
16.7.14	Select Top Layer	538
16.7.15	Select Bottom Layer	538
16.7.16	Raise Layer	538
16.7.17	Lower Layer	538
16.7.18	Layer to Top	539
16.7.19	Layer to Bottom	539
16.7.20	The “Reverse Layer Order” command	539
16.7.21	The “Mask” Submenu	539
16.7.22	Add Layer Mask	540
16.7.23	Apply Layer Mask	541
16.7.24	Delete Layer Mask	541
16.7.25	Show Layer Mask	541
16.7.26	Edit Layer Mask	542
16.7.27	Disable Layer Mask	542
16.7.28	Mask to Selection	542
16.7.29	Add Layer Mask to Selection	543
16.7.30	Subtract Layer Mask from Selection	543
16.7.31	Intersect Layer Mask with Selection	544
16.7.32	The “Transparency” Submenu of the “Layer” menu	544
16.7.33	Add Alpha Channel	545
16.7.34	Remove Alpha Channel	545
16.7.35	Color to Alpha	545
16.7.36	Semi-flatten	545
16.7.37	Threshold Alpha	546
16.7.38	Alpha to Selection	547

16.7.39	Add Alpha channel to Selection	547
16.7.40	Subtract from Selection	548
16.7.41	Intersect Alpha channel with Selection	548
16.7.42	The “Transform” Submenu	549
16.7.43	Flip Horizontally	550
16.7.44	Flip Vertically	550
16.7.45	Rotate 90° clockwise	551
16.7.46	Rotate 90° counter-clockwise	551
16.7.47	Rotate 180°	551
16.7.48	Arbitrary Rotation	552
16.7.49	Offset	552
16.7.50	Layer Boundary Size	554
16.7.51	Layer to Image Size	556
16.7.52	Scale Layer	556
16.7.53	Crop Layer	557
16.8	The “Colors” Menu	558
16.8.1	Introduction to the “Colors” Menu	558
16.8.2	Color Balance	559
16.8.3	Color Temperature	561
16.8.4	Hue Chroma	561
16.8.5	Hue-Saturation	562
16.8.6	Saturation	564
16.8.7	Exposure	564
16.8.8	Shadows-Highlights	565
16.8.9	Brightness-Contrast	566
16.8.10	Levels	567
16.8.11	Curves	572
16.8.12	Invert	576
16.8.13	Linear Invert	577
16.8.14	Value Invert	577
16.8.15	The “Auto” Submenu	578
16.8.16	Equalize	580
16.8.17	White Balance	580
16.8.18	Stretch Contrast	581
16.8.19	Stretch HSV	582
16.8.20	Color Enhance	582
16.8.21	Color Enhance (legacy)	583
16.8.22	The “Components” Submenu	583
16.8.23	Channel Mixer	584
16.8.24	Extract Component	587
16.8.25	Mono Mixer	588
16.8.26	Compose	589
16.8.27	Decompose	591
16.8.28	Recompose	593
16.8.29	Color to Gray	593
16.8.30	Desaturate	593
16.8.31	Sepia	597
16.8.32	The “Map” Submenu	598
16.8.33	Rearrange Colormap	599
16.8.34	Set Colormap	600
16.8.35	Alien Map	600
16.8.36	Color Exchange	601
16.8.37	Rotate Colors	602
16.8.38	Gradient Map	605
16.8.39	Palette Map	606
16.8.40	Sample Colorize	607
16.8.41	Fattal et al. 2002	609
16.8.42	Mantiuk 2006	609
16.8.43	Reinhard 2005	609

16.8.44	Stress	609
16.8.45	Retinex	609
16.8.46	The “Info” Submenu	610
16.8.47	Histogram	611
16.8.48	Border Average	612
16.8.49	Colorcube Analysis	613
16.8.50	Export Histogram	614
16.8.51	Smooth Palette	615
16.8.52	Threshold	615
16.8.53	Colorize	619
16.8.54	Posterize	620
16.8.55	Color to Alpha...	621
16.8.56	Dither	625
16.8.57	RGB Clip	625
16.8.58	Hot...	625
16.9	The “Tools” Menu	626
16.9.1	Introduction to the “Tools” Menu	626
16.10	The “Filters” Menu	627
16.10.1	Introduction to the “Filters” Menu	627
16.10.2	Repeat Last	627
16.10.3	Re-show Last	628
16.10.4	Reset All Filters	628
16.10.5	The “Python-Fu” Submenu	629
16.10.6	The “Script-Fu” Submenu	631
16.11	“Windows” Menu	633
16.12	The “Help” Menu	634
16.12.1	Introduction to the “Help” Menu	634
16.12.2	Help	635
16.12.3	Context Help	635
16.12.4	Tip of the Day	635
16.12.5	About	636
16.12.6	Plug-In Browser	637
16.12.7	The Procedure Browser	638
16.12.8	GIMP online	639
17	Filters	641
17.1	Introduction	641
17.2	Common Features	641
17.3	Blur Filters	643
17.3.1	Introduction	643
17.3.2	Gaussian Blur	645
17.3.3	Mean Curvature Blur	646
17.3.4	Median Blur	649
17.3.5	Pixelize	652
17.3.6	Selective Gaussian Blur	653
17.3.7	Circular Motion Blur	654
17.3.8	Linear Motion Blur	655
17.3.9	Zoom Motion Blur	656
17.3.10	Tileable Blur	658
17.4	Enhance Filters	659
17.4.1	Introduction	659
17.4.2	Antialias	659
17.4.3	Deinterlace	661
17.4.4	High Pass	662
17.4.5	Noise Reduction	664
17.4.6	Red Eye Removal	667
17.4.7	Symmetric Nearest Neighbor	667
17.4.8	Sharpen (Unsharp Mask)	668
17.4.9	Despeckle	671

17.4.10	Destripe	672
17.4.11	NL Filter	673
17.4.12	Wavelet Decompose	675
17.5	Distort Filters	677
17.5.1	Introduction	677
17.5.2	Apply Lens	678
17.5.3	Emboss	679
17.5.4	Engrave	681
17.5.5	Lens Distortion	682
17.5.6	Mosaic	685
17.5.7	Polar Coordinates	687
17.5.8	Ripple	689
17.5.9	Shift	692
17.5.10	Spherize	693
17.5.11	Value Propagate	696
17.5.12	Video	699
17.5.13	Waves	700
17.5.14	Whirl and Pinch	702
17.5.15	Wind	704
17.5.16	Curve Bend	706
17.5.17	Emboss (legacy)	708
17.5.18	Newsprint	709
17.5.19	Page Curl	711
17.6	Light and Shadow Filters	713
17.6.1	Introduction	713
17.6.2	Supernova	713
17.6.3	Lens Flare	715
17.6.4	Gradient Flare	716
17.6.5	Lighting Effects	721
17.6.6	Sparkle	725
17.6.7	Drop Shadow	727
17.6.8	Long Shadow	729
17.6.9	Vignette	731
17.6.10	Drop Shadow (legacy)	734
17.6.11	Perspective	735
17.6.12	Xach-Effect	738
17.7	Noise Filters	739
17.7.1	Introduction	739
17.7.2	CIE lch Noise	740
17.7.3	HSV Noise	741
17.7.4	Hurl	742
17.7.5	Pick	743
17.7.6	RGB Noise	745
17.7.7	Slur	746
17.7.8	Spread	748
17.8	Edge-Detect Filters	749
17.8.1	Introduction	749
17.8.2	Difference of Gaussians	750
17.8.3	Edge	751
17.8.4	Laplace	754
17.8.5	Neon	755
17.8.6	Sobel	756
17.8.7	Image Gradient	757
17.9	Generic Filters	759
17.9.1	Introduction	759
17.9.2	Convolution Matrix	760
17.9.3	Distance Map	763
17.9.4	GEGL graph	765
17.9.5	Normal Map	766

17.9.6 Dilate	769
17.9.7 Erode	770
17.10 Combine Filters	770
17.10.1 Introduction	770
17.10.2 Depth Merge	770
17.10.3 Filmstrip	773
17.11 Artistic Filters	775
17.11.1 Introduction	775
17.11.2 Apply Canvas	775
17.11.3 Cartoon	777
17.11.4 Cubism	778
17.11.5 Glass Tile	780
17.11.6 Oilify	781
17.11.7 Photocopy	783
17.11.8 Simple Linear Iterative Clustering (SLIC)	784
17.11.9 Softglow	786
17.11.10 Waterpixels	787
17.11.11 Cartoon (legacy)	789
17.11.12 Clothify	790
17.11.13 GIMPressionist	791
17.11.14 Oilify (legacy)	801
17.11.15 Predator	803
17.11.16 Softglow (legacy)	804
17.11.17 Van Gogh (LIC)	805
17.11.18 Weave	808
17.12 Decor Filters	810
17.12.1 Introduction	810
17.12.2 Add Bevel	810
17.12.3 Add Border	812
17.12.4 Coffee Stain	813
17.12.5 Fog	814
17.12.6 Fuzzy Border	815
17.12.7 Old Photo	817
17.12.8 Round Corners	819
17.12.9 Slide	821
17.12.10 Stencil Carve	822
17.12.11 Stencil Chrome	824
17.13 Map Filters	827
17.13.1 Introduction	827
17.13.2 Bump Map	827
17.13.3 Displace	830
17.13.4 Fractal Trace	836
17.13.5 Illusion	837
17.13.6 Little Planet	838
17.13.7 Panorama Projection	841
17.13.8 Recursive Transform	843
17.13.9 Paper Tile	846
17.13.10 Tile Seamless	848
17.13.11 Fractal Trace (legacy)	849
17.13.12 Map Object	850
17.13.13 Tile	854
17.14 Rendering Filters	855
17.14.1 Introduction	855
17.14.2 Flame	855
17.14.3 Fractal Explorer	859
17.14.4 IFS Fractal	863
17.14.5 Cell Noise	867
17.14.6 Perlin Noise	868
17.14.7 Plasma	870

17.14.8 Simplex Noise	871
17.14.9 Solid Noise	872
17.14.10 Difference Clouds	874
17.14.11 Bayer Matrix	875
17.14.12 Checkerboard	877
17.14.13 Diffraction Patterns	878
17.14.14 Grid	879
17.14.15 Maze	881
17.14.16 Sinus	882
17.14.17 Checkerboard (legacy)	884
17.14.18 CML Explorer	885
17.14.19 Grid (legacy)	890
17.14.20 Jigsaw	892
17.14.21 Qbist	893
17.14.22 Circuit	894
17.14.23 Gfig	896
17.14.24 Lava	899
17.14.25 Line Nova	900
17.14.26 Sphere Designer	902
17.14.27 Spyrogimp	904
17.15 Web Filters	910
17.15.1 Introduction	910
17.15.2 ImageMap	910
17.15.3 Semi-Flatten	915
17.15.4 Slice	916
17.16 Animation Filters	919
17.16.1 Introduction	919
17.16.2 Blend	919
17.16.3 Burn-In	920
17.16.4 Rippling	922
17.16.5 Spinning Globe	923
17.16.6 Waves	924
17.16.7 Optimize	925
17.16.8 Playback	926
IV Keys and Mouse Reference	927
17.17 File	929
17.18 Edit	929
17.19 Select	930
17.20 View	931
17.21 Image	932
17.22 Layers	932
17.23 Tools	932
17.24 Filters	934
17.25 Windows	934
17.26 Help	935
17.27 Zoom tool	935
V Glossary	937
VI Bibliography	959
17.28 Books	961
17.29 Online resources	961

VII	GIMP History	965
.1	The Very Beginning	967
.2	The Early Days of GIMP	967
.3	The One to Change the World	968
.4	Version 2.0	968
.5	What's New in GIMP 2.2?	971
.6	What's New in GIMP 2.4?	972
.7	What's New in GIMP 2.6?	974
.8	What's New in GIMP 2.8?	978
.9	What's new in GIMP 2.10?	985
VIII	Reporting Bugs and Requesting Enhancements	991
.10	Making sure it's a Bug	993
.10.1	Find a Specific Bug	993
.11	Reporting the Bug	994
IX	How to Contribute	995
.12	Prerequisites	997
.12.1	Join our mailing list	997
.12.2	Create a Local Working Copy of Code	997
.12.3	Installing your sandbox	997
.12.4	The gimp-help folder	997
.13	Workflow	997
.13.1	Writing	997
.13.2	Validating	998
.13.3	Images	998
.13.4	Create HTML Files	999
.13.5	Sending your files	999
.14	Annexes	1000
.15	Working under Windows	1000
.15.1	Adapting Cygwin to use with GIMP documentation tools	1001
X	Tone Mapping and Shadow Recovery Using GIMP's 'Colors/Exposure'	1003
.16	High bit depth GIMP's floating point "Colors/Exposure": much better than Curves for lightening the shadows and midtones of an image without blowing the highlights	1005
.17	A step-by-step example showing how to recover shadow information using high bit depth GIMP's floating point "Colors/Exposure"	1006
.18	Use Notes	1013
.19	Conclusion	1020
XI	GNU Free Documentation License	1023
.20	PREAMBLE	1025
.21	APPLICABILITY AND DEFINITIONS	1025
.22	VERBATIM COPYING	1026
.23	COPYING IN QUANTITY	1026
.24	MODIFICATIONS	1027
.25	COMBINING DOCUMENTS	1028
.26	COLLECTIONS OF DOCUMENTS	1028
.27	AGGREGATION WITH INDEPENDENT WORKS	1028
.28	TRANSLATION	1028
.29	TERMINATION	1029
.30	FUTURE REVISIONS OF THIS LICENSE	1029
.31	ADDENDUM: How to use this License for your documents	1029

XII	Eeek! There is Missing Help	1031
	Index	1035

List of Examples

16.1	Crop marks	592
17.1	Simple “Slice” filter example output	916
17.2	With separate image folder	917
17.3	Space between table elements	917
17.4	JavaScript code snippet	918
17.5	Skipped animation for table caps (simplified HTML code)	918

Preface

GIMP User Manual Authors and Contributors

Content Writers Alex Muñoz (Spanish), Alexandre Franke (French), Alexandre Prokoudine (Russian), Angelo Córdoba Inunza (Spanish), Christian Kirbach (German), Daniel Francis (Spanish), Daniel Mustieles (Spanish), Daniel Winzen (German), Delin Chang (Chinese), Dimitris Spingos (Greek), Djavan Fagundes (Brazilian), Enrico Nicoletto (Brazilian), Felipe Ribeiro (Brazilian), Guiu Rocafort (Spanish), Jiro Matsuzawa (Japanese), Joe Hansen (Danish), João S. O. Bueno (Brazilian), Julien Hardelin (French, English), Kenneth Nielsen (Danish), Kolbjørn Stuestøl (Norwegian), Marco Ciampa (Italian), María Majadas (Spanish), Milagros Infante Montero (Spanish), Milo Casagrande (Italian), Piotr Drąg (Polish), Rafael Ferreira (Brazilian), Róman Joost (German, English), Seong-ho Cho (Korean), SimaMoto,RyōTa () (Japanese), Sven Claussner (German, English), Timo Jyrinki (Finnish), Ulf-D. Ehlert (German), Vitaly Lomov (Russian), Willer Gomes Junior (Brazilian), Yuri Myasoedov (Russian), Equip de Softcatalà (Catalan), Jacob Boerema (Wormnest) (English)

Proof Reading Stéphane Poumaer (French), Axel Wernicke (German, English), Alessandro Falappa (Italian), Manuel Quiñones (Spanish), Ignacio Antl (Spanish), Choi Ji-Hui() (Korean), Nickolay V. Shmyrev (Russian), Albin Bernharsson (Swedish), Daniel Nylander (Swedish), Patrycja Stawiarska (Polish), Andrew Pitonyak (English), Jakub Friedl (Czech, English), Hans De Jonge (Dutch), Raymon Van Wanrooij (Dutch), Semka Kuloviač-Debals (Croatian), Sally C. Barry (English), Daniel Egger (English), Sven Neumann (English, German), Domingo Stephan (German), Thomas Lotze (German), Thomas Güttler (German), Zhong Yaotang (Chinese), Calum Mackay (English), Thomas S Lendo (German), Mel Boyce (syngin) (English), Oliver Ellis (Red Haze) (English), Markus Reinhardt (German), Alexander Weiher (German), Michael Hölzen (German), Raymond Ostertag (French), Cédric Gémy (French), Sébastien Barre (French), Niklas Mattison (Swedish), Daryl Lee (English), William Skaggs (English), Cai Qian () (Chinese), Yang Hong () (Chinese), Xceals (Chinese), Eric Lamarque (Chinese), Robert van Drunen (Dutch), Marco Marega (Italian), Mike Vargas (Italian), Andrea Zito (Italian), Karine Delvare (French), David 'Ilicz' Klementa (Czech), Jan Smith (English), Adolf Gerold (German), Roxana Chernogolova (Russian), Grigory Bakunov (Russian), Oleg Fritz (Russian), Mick Curtis (English), Vitaly Lomov (Russian), Pierre PERRIER (French), Oliver Heesakke (Dutch), Susanne Schmidt (English, German), Ben (German), Daniel Hornung (English), Sven Claussner (English, German)

Graphics, Stylesheets Jakub Steiner, Øyvind Kolås

Build System, Technical Contributions Kenneth Nielsen, Róman Joost, Axel Wernicke, Nickolay V. Shmyrev, Daniel Egger, Sven Neumann, Michael Natterer (mitch), Henrik Brix Andersen (brix), Thomas Schraitle, Chris Hübsch, Anne Schneider, Peter Volkov, Daniel Richard, Jacob Boerema (Wormnest)

Part I

Getting Started

Chapter 1

Introduction

1.1 Welcome to GIMP

GIMP is a multi-platform tool to create and edit images of all kinds. GIMP is an acronym for GNU Image Manipulation Program.

GIMP has many capabilities. It can be used as a simple paint program, an expert quality photo retouching program, a tool to create digital art, an online batch processing system, a mass production image renderer, an image format converter, etc.

GIMP is expandable and extensible. It is designed to be augmented with plug-ins and extensions to do just about anything. The advanced scripting interface allows everything from the simplest task to the most complex image manipulation procedures to be easily scripted.

One of GIMP's strengths is its free availability from many sources for many operating systems. Most GNU / Linux distributions include GIMP as a standard application. GIMP is also available for other operating systems such as Microsoft Windows or Apple's macOS (Darwin). GIMP is a Free Software application covered by the General Public License version 3 [GPL]. The GPL provides users with the freedom to access and alter the source code that makes up computer programs.

1.1.1 Authors

The first version of GIMP was written by Peter Mattis and Spencer Kimball. Over the years many other people have contributed by helping with development, testing, providing support, translating and writing documentation. GIMP releases are currently being orchestrated by Mitch Natterer and Jehan Pagès and the other members of the GIMP-Team.

1.1.2 The GIMP Help system

The GIMP Documentation Team provides the information that tries to help you understand how to use GIMP. The User Manual is an important part of this help. The latest version is always available on the website of the Documentation Team [GIMP-DOCS] in HTML format. The HTML version is also available as context sensitive help (needs to be installed separately) while using GIMP by pressing the **F1** key. Help on specific menu items can be accessed by pressing the **F1** key while the mouse pointer is focused on the menu item. Read on to begin your GIMP journey.

1.1.3 Features and Capabilities



The following list is a short overview of some of the features and capabilities which GIMP offers you:

- A full suite of painting tools including brushes, a pencil, an airbrush, cloning, etc.
- Tile-based memory management, so image size is limited only by available disk space.
- Sub-pixel sampling for all paint tools for high-quality anti-aliasing.
- Full Alpha channel support for working with transparency.
- Layers and channels.

- A procedural database for calling internal GIMP functions from external programs, such as Script-Fu.
- Advanced scripting capabilities.
- Multiple undo/redo (limited only by disk space).
- Transformation tools including rotate, scale, shear and flip.
- Support for a wide range of file formats, including JPEG, PNG, GIF, PSD, DDS, XPM, TIFF, TGA, MPEG, PS, PDF, PCX, BMP and many others.
- Selection tools, including rectangle, ellipse, free, fuzzy, bezier and intelligent scissors.
- Plug-ins that allow for the easy addition of new file formats and new effect filters.

1.2 What's new in GIMP 2.10.18?

GIMP-2.10.16 release was skipped, due to a critical bug. It has been fixed. Here are GIMP-2.10.18 release highlights:

- Tools are now grouped in the toolbox by default: Section [14.1.2](#).
- Sliders now use a compact style with improved user interaction: [New sliders](#).
- Vastly improved user experience for the transformation preview: [Composited preview](#).
- Dockable areas now highlighted when a dockable dialog is being dragged.
- New 3D Transform tool to rotate and pan items: Section [14.4.9](#).
- Much smoother brush outline preview motion on the canvas.
- Symmetry painting enhancements
- Faster loading of ABR brushes: GIMP now spends a lot less time loading Photoshop's brushes (ABR). So if you use a lot of those, the startup time will become pleasantly smaller, by order of a magnitude. The technical explanation is that GIMP used to read the stream of ABR data byte by byte, and now it uses scanline reading instead.
- PSD support improvements: PSD support improvements PSD files now load faster mostly by eliminating excessive copies between the original file and the project representation inside GIMP. For large PSD files, the loading is now ~1.5 to ~2 times faster. Moreover, GIMP is now capable of loading CMYK(A) PSD files (only 8-bit per channel for now). It does so by converting pixels to RGB(A) float using sRGB as the profile which, we know, is not good enough for serious work. However, the plug-in is already using BABL formats to specify and communicate CMYK pixel format encodings with GIMP. This is a good first step towards better CMYK support. It can be improved both on its own as well as integrate with the ongoing work enabling general color-space support for BABL formats in the development branch.
- Consolidated user interface for merging down and anchoring layers:  [Merge layers](#)  [Anchor layer](#)
- Update check to notify users of new releases available

Chapter 2

Fire up GIMP

2.1 Running GIMP

Usually you start GIMP either by clicking an icon (if your system is set up to provide you with one), or by typing **gimp** on a command line. If you have multiple versions of GIMP installed, you may need to type **gimp-2.10** to get the newest version. You can, if you want, provide a list of image file names on the command line after the program name so that GIMP automatically opens those files after it starts. It is also possible, though, to open files from within GIMP once it is running.

Most operating systems support file associations, which associates a class of files (as determined by their filename extension, such as .jpg) with a corresponding application (such as GIMP). When image files are properly “associated” to GIMP, you can double click an image to open it in GIMP.

2.1.1 Known Platforms

GIMP is the most widely supported image manipulation program available today. The platforms on which GIMP is known to work include:

GNU/Linux, Apple macOS, Microsoft Windows, OpenBSD, NetBSD, FreeBSD, Solaris, SunOS, AIX, HP-UX, Tru64, Digital UNIX, OSF/1, IRIX, OS/2, and BeOS.

GIMP is easily ported to other operating systems because of its source code availability. For further information visit the GIMP developers homepage. [[GIMP-DEV](#)].

2.1.2 Language

GIMP automatically detects and uses the system language. In the unlikely event that language detection fails, or if you want to use a different language, with GIMP-2.8 and newer, you can do so through: Edit → Preferences → Interface.

You can also use:

Under Linux *In LINUX*: in console mode, type **LANGUAGE=en gimp** or **LANG=en gimp** replacing en with fr, de, ... according to the language you want. Background: Using **LANGUAGE=en** sets an environment variable for the executed program **gimp**.

Under Windows Control Panel → System → Advanced → Environment button in “System Variables” area: Add button: Enter LANG for Name and fr or de... for Value. Watch out! You have to click OK three successive times to validate your choice.

If you change languages often, you can create a batch file to change the language. Open NotePad. Type the following commands (for French for instance):

```
set lang=fr
start gimp-2.10.exe
```

Save this file as **GIMP-FR.BAT** (or another name, but always with a .BAT extension). Create a shortcut and drag it to your desktop.

Another possibility: Start → Programs → GTK Runtime Environment Then Select language and select the language you want in the drop-down list.

Under Apple macOS From System Preferences, click the International icon. In the Language tab, the desired language should be the first in the list.

Another GIMP instance Use `-n` to run multiple instances of GIMP. For example, use `gimp-2.10` to start GIMP in the default system language, and `LANGUAGE=en gimp-2.10 -n` to start another instance of GIMP in English; this is very useful for translators.

2.1.3 Command Line Arguments

Although arguments are not required when starting GIMP, the most common arguments are shown below. On a Unix system, you can use `man gimp` for a complete list.

Command line arguments must be in the command line that you use to start GIMP as `gimp-2.10 [OPTION...] [FILE | URI...]`.

- `-, --help` Display a list of all commandline options.
- `--help-all` Show all help options.
- `--help-gtk` Show GTK+ Options.
- `-v, --version` Print the GIMP version and exit.
- `--license` Show license information and exit.
- `--verbose` Show detailed start-up messages.
- `-n, --new-instance` Start a new GIMP instance.
- `-a, --as-new` Open images as new.
- `-i, --no-interface` Run without a user interface.
- `-d, --no-data` Do not load patterns, gradients, palettes, or brushes. Often useful in non-interactive situations where start-up time is to be minimized.
- `-f, --no-fonts` Do not load any fonts. This is useful to load GIMP faster for scripts that do not use fonts, or to find problems related to malformed fonts that hang GIMP.
- `-s, --no-splash` Do not show the splash screen while starting.
- `--no-shm` Do not use shared memory between GIMP and plugins.
- `--no-cpu-accel` Do not use special CPU acceleration functions. Useful for finding or disabling buggy accelerated hardware or functions.
- `--session=name` Use a different `sessionrc` for this GIMP session. The given session name is appended to the default `sessionrc` filename.
- `--gimprc=filename` Use an alternative `gimprc` instead of the default one. The `gimprc` file contains a record of your preferences. Useful in cases where plugins paths or machine specs may be different.
- `--system-gimprc=filename` Use an alternate system `gimprc` file.
- `-b, --batch=commands` Execute the set of commands non-interactively. The set of commands is typically in the form of a script that can be executed by one of the GIMP scripting extensions. When the command is `-`, commands are read from standard input.
- `--batch-interpret=proc` Specify the procedure to use to process batch commands. The default procedure is Script-Fu.
- `--console-messages` Do not display dialog boxes on errors or warnings. Print the messages on the console instead.
- `--pdb-compat-mode=mode` PDB compatibility mode (`off` | `on` | `warn`).
- `--stack-trace-mode=mode` Debug in case of a crash (`never` | `query` | `always`).

- debug-handlers** Enable non-fatal debugging signal handlers. Useful for GIMP debugging.
- g-fatal-warnings** Make all warnings fatal. Useful for debugging.
- dump-gimprc** Output a gimprc file with default settings. Useful if you messed up the gimprc file.
- display=*display*** Use the designated X display (does not apply to all platforms).

2.2 Starting GIMP the first time

When first run, GIMP performs a series of steps to configure options and directories. The configuration process creates a subdirectory in your home directory named `.gimp-2.10`. All of the configuration information is stored in this directory. If you remove or rename the directory, GIMP repeats the initial configuration process, creating a new `.gimp-2.10` directory. Use this capability to explore different configuration options without deleting your existing installation, or to recover if your configuration files are damaged.

2.2.1 Finally . . .

Just a couple of suggestions before you start, though: First, GIMP provides tips you can read at any time using the menu command Help → Tip of the Day. The tips provide information that is considered useful, but not easy to learn by experimenting; so they are worth reading. Please read the tips when you have the time. Second, if at some point you are trying to do something, and GIMP seems to have suddenly stopped functioning, the section [Getting Unstuck](#) may help you out. Happy Gimping!

Chapter 3

First Steps with Wilber

3.1 Basic Concepts

Figure 3.1 Wilber, the GIMP mascot



The Wilber Construction Kit (docs/Wilber_Construction_Kit.xcf.gz) allows you to give the mascot a different appearance. It is the work of Tuomas Kuosmanen (tigertATgimp.org).

This section provides a brief introduction to the basic concepts and terminology used in GIMP. The concepts presented here are explained in much greater depth elsewhere. With a few exceptions, we have avoided cluttering this section with a lot of links and cross-references: everything mentioned here is so high-level that you can easily locate it in the index.

Images Images are the basic entities used by GIMP. Roughly speaking, an “image” corresponds to a single file, such as a TIFF or JPEG file. You can also think of an image as corresponding to a single display window (although in truth it is possible to have multiple windows all displaying the same image). It is not possible to have a single window display more than one image, though, or for an image to have no window displaying it.

A GIMP image may be quite a complicated thing. Instead of thinking of it as a sheet of paper with a picture on it, think of it as more like a stack of sheets, called “layers”. In addition to a stack of layers, a GIMP image may contain a selection mask, a set of channels, and a set of paths. In fact, GIMP provides a mechanism for attaching arbitrary pieces of data, called “parasites”, to an image.

In GIMP, it is possible to have many images open at the same time. Although large images may use many megabytes of memory, GIMP uses a sophisticated tile-based memory management system that allows GIMP to handle very large images gracefully. There are limits, however, and having more memory available may improve system performance.

Layers If a simple image can be compared to a single sheet of paper, an image with layers is likened to a sheaf of transparent papers stacked one on top of the other. You can draw on each paper, but still see the content of the other sheets through the transparent areas. You can also move one sheet in relation to the others. Sophisticated GIMP users often deal with images containing many layers, even dozens of them. Layers need not be opaque, and they need not cover the entire extent of an

image, so when you look at an image's display, you may see more than just the top layer: you may see elements of many layers.

Resolution Digital images consist of a grid of square pixels. Each image has a size measured in two dimensions, such as 900 pixels wide by 600 pixels high. But pixels don't have a set size in physical space. To set up an image for printing, we use a value called resolution, defined as the ratio between an image's size in pixels and its physical size (usually in inches) when it is printed on paper. Most file formats (but not all) can save this value, which is expressed as ppi—pixels per inch.

When printing a file, the resolution determines the size the image will have on paper, and as a result, the physical size of the pixels. The same 900x600 pixel image may be printed as a small 3x2" card with barely noticeable pixels—or as a large poster with large, chunky pixels.

Images imported from cameras and mobile devices tend to have a resolution attached to the file. The resolution is usually 72 or 96ppi. It is important to realize that this resolution is arbitrary and was chosen for historic reasons. You can always change the resolution with GIMP—this has no effect on the actual image pixels. Furthermore, for uses such as displaying images online, on mobile devices, television or video games—in short, any use that is not print—the resolution value is meaningless and is ignored. Instead, the image is usually displayed so that each image pixel conforms to one screen pixel.

Channels A Channel is a single component of a pixel's color. For a colored pixel in GIMP, these components are usually Red, Green, Blue and sometimes transparency (Alpha). For a **Grayscale** image, they are Gray and Alpha and for an **Indexed** color image, they are Indexed and Alpha.

The entire rectangular array of any one of the color components for all of the pixels in an image is also referred to as a Channel. You can see these color channels with the **Channels dialog**.

When the image is displayed, GIMP puts these components together to form the pixel colors for the screen, printer, or other output device. Some output devices may use different channels from Red, Green and Blue. If they do, GIMP's channels are converted into the appropriate ones for the device when the image is displayed.

Channels can be useful when you are working on an image which needs adjustment in one particular color. For example, if you want to remove "red eye" from a photograph, you might work on the Red channel.

You can look at channels as masks which allow or restrict the output of the color that the channel represents. By using Filters on the channel information, you can create many varied and subtle effects on an image. A simple example of using a Filter on the color channels is the **Channel Mixer** filter.

In addition to these channels, GIMP also allows you to create other channels (or more correctly, Channel Masks), which are displayed in the lower part of the Channels dialog. You can create a **New Channel** or save a **selection to a channel (mask)**. See the glossary entry on **Masks** for more information about Channel Masks.

Selections Often when modifying an image, you only want a part of the image to be affected. The "selection" mechanism makes this possible. Each image has its own selection, which you normally see as a moving dashed line separating the selected parts from the unselected parts (the so-called "marching ants"). Actually this is a bit misleading: selection in GIMP is graded, not all-or-nothing, and really the selection is represented by a full-fledged grayscale channel. The dashed line that you normally see is simply a contour line at the 50%-selected level. At any time, though, you can visualize the selection channel in all its glorious detail by toggling the **QuickMask** button.

A large component of learning how to use GIMP effectively is acquiring the art of making good selections—selections that contain exactly what you need and nothing more. Because selection-handling is so centrally important, GIMP provides many tools for doing it: an assortment of selection-making tools, a menu of selection operations, and the ability to switch to Quick Mask mode, in which you can treat the selection channel as though it were a color channel, thereby "painting the selection".

Undoing When you make mistakes, you can undo them. Nearly everything you can do to an image is undoable. In fact, you can usually undo a substantial number of the most recent things you did, if you decide that they were misguided. GIMP makes this possible by keeping a history of your actions. This history consumes memory, though, so undoability is not infinite. Some actions use

very little undo memory, so that you can do dozens of them before the earliest ones are deleted from this history; other types of actions require massive amounts of undo memory. You can configure the amount of memory GIMP allows for the undo history of each image, but in any situation, you should always be able to undo at least your 2-3 most recent actions. (The most important action that is not undoable is closing an image. For this reason, GIMP asks you to confirm that you really want to close the image if you have made any changes to it.)

Plug-ins Many, probably most, of the things that you do to an image in GIMP are done by the GIMP application itself. However, GIMP also makes extensive use of “plug-ins”, which are external programs that interact very closely with GIMP, and are capable of manipulating images and other GIMP objects in very sophisticated ways. Many important plug-ins are bundled with GIMP, but there are also many available by other means. In fact, writing plug-ins (and scripts) is the easiest way for people not on the GIMP development team to add new capabilities to GIMP.

All of the commands in the Filters menu, and a substantial number of commands in other menus, are actually implemented as plug-ins.

Scripts In addition to plug-ins, which are programs written in the C language, GIMP can also make use of scripts. The largest number of existing scripts are written in a language called Script-Fu, which is unique to GIMP (for those who care, it is a dialect of the Lisp-like language called Scheme). It is also possible to write GIMP scripts in Python or Perl. These languages are more flexible and powerful than Script-Fu; their disadvantage is that they depend on software that does not automatically come packaged with GIMP, so they are not guaranteed to work correctly in every GIMP installation.

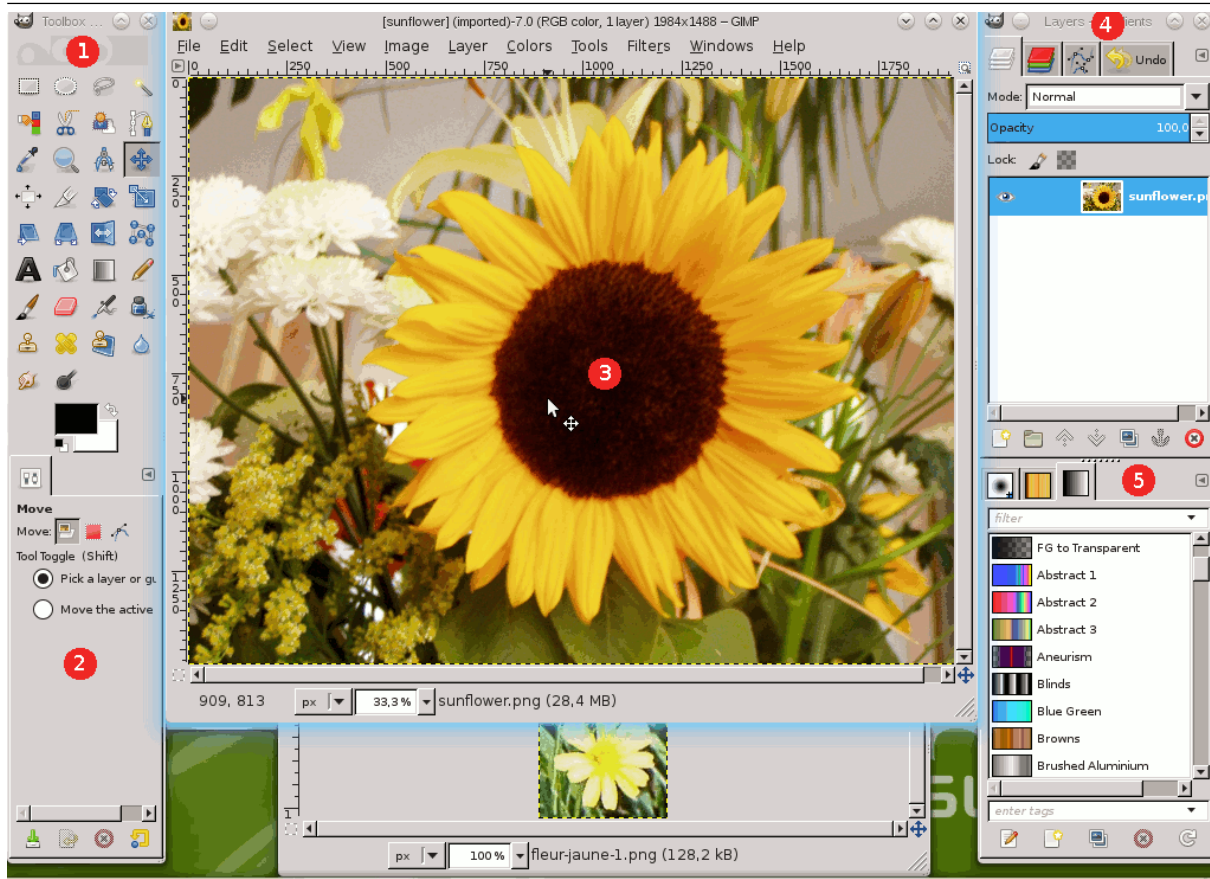
3.2 Main Windows

The GIMP user interface is now available in two modes:

- multi-window mode,
- single window mode.

When you open GIMP for the first time, it opens in single-window mode by default. You can enable multi-window mode unchecking Windows → >Single-Window Mode) option in the image menu bar. After quitting GIMP, GIMP will start in the mode you have selected next time.

Multi-Window Mode

Figure 3.2 A screenshot illustrating the multi-window mode.

The screenshot above shows the most basic arrangement of GIMP windows that can be used effectively.

You can notice two panels, left and right, and an image window in middle. A second image is partially masked. The left panel collects Toolbox and Tool Options dialog together. The right panel collects Layers, Channels, Paths, Undo History dialogs together in a multi-tab dock, and Brushes, Patterns, Gradients, Fonts, History, Paint dynamics editor, Palette editor dialogs together in another multi-tab dock.

1. *The Main Toolbox*: Contains a set of icon buttons used to select tools. By default, it also contains the foreground and background colors. You can add brush, pattern, gradient and active image icons. Use `Edit → Preferences → Toolbox` to enable, or disable the extra items.
2. *Tool options*: Docked below the main Toolbox is a Tool Options dialog, showing options for the currently selected tool (in this case, the Move tool).
3. *Image windows*: Each image open in GIMP is displayed in a separate window. Many images can be open at the same time, limited by only the system resources. Before you can do anything useful in GIMP, you need to have at least one image window open. The image window holds the Menu of the main commands of GIMP (File, Edit, Select...), which you can also get by right-clicking on the window.

An image can be bigger than the image window. In that case, GIMP displays the image in a reduced zoom level which allows to see the full image in the image window. If you turn to the 100% zoom level, scroll bars appear, allowing you to pan across the image.

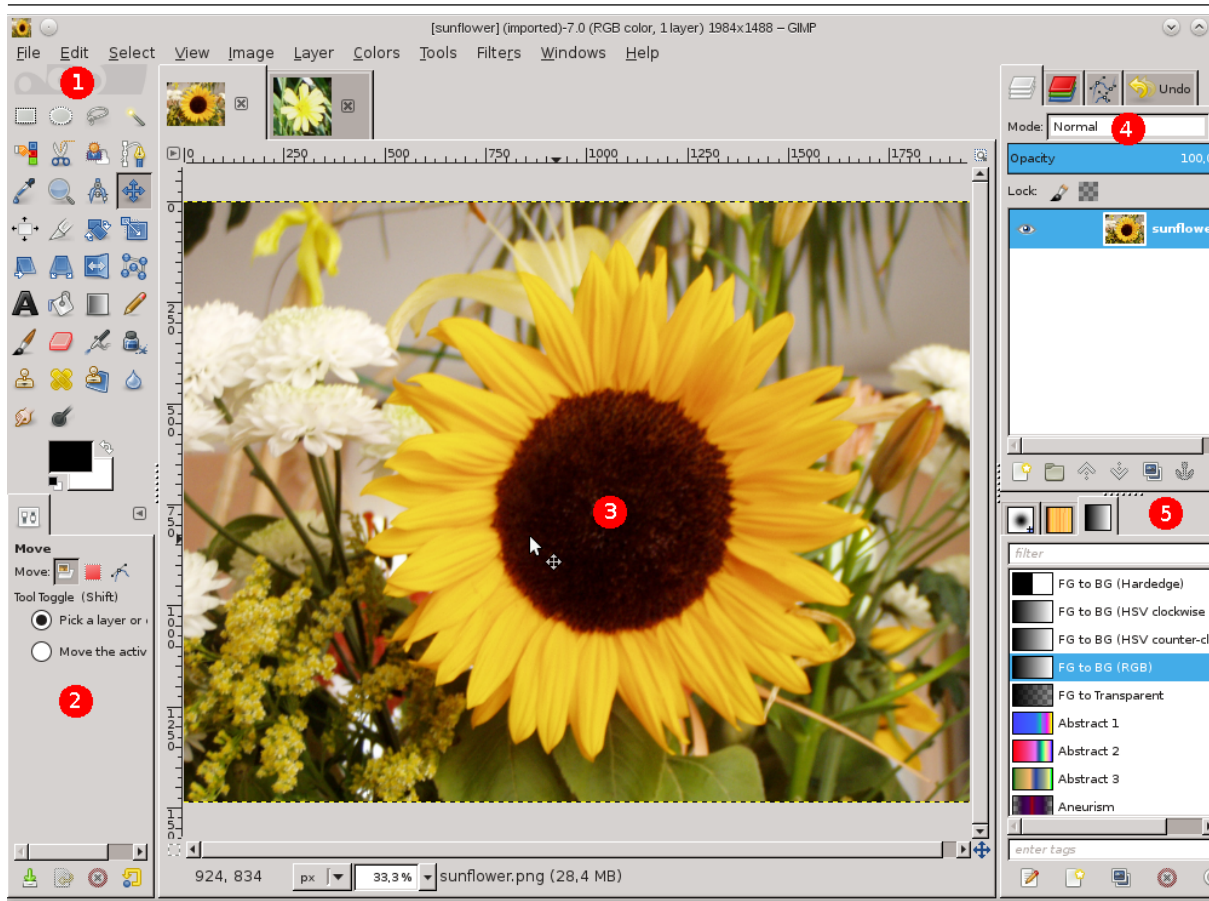
4. The *Layers, Channels, Paths, Undo History* dock — note that the dialogs in the dock are tabs. The Layers tab is open : it shows the layer structure of the currently active image, and allows it to be manipulated in a variety of ways. It is possible to do a few very basic things without using the Layers dialog, but even moderately sophisticated GIMP users find it indispensable to have the Layers dialog available at all times.

5. *Brushes/Patterns/Gradients*: The docked dialog below the layer dialog shows the dialogs (tabs) for managing brushes, patterns and gradients.

Dialog and dock managing is described in Section 3.2.3.

Single Window Mode

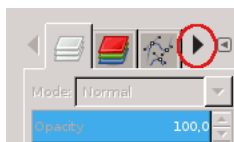
Figure 3.3 A screenshot illustrating the single-window mode.



You find the same elements, with differences in their management:

- Left and right panels are fixed; you can't move them. But you can decrease or increase their width by dragging the moving pointer that appears when the mouse pointer overflies the right border of the left pane. If you want to keep the left pane narrow, please use the slider at the bottom of the tool options to pan across the options display.

If you reduce the width of a multi-tab dock, there may be not enough place for all tabs; then arrow-heads appear allowing you to scroll through tabs.




As in multi-window mode, you can mask these panels using the **Tab** key.

- The image window occupies all space between both panels. When several images are open, a new bar appears above the image window, with a tab for every image. You can navigate between images by clicking on tabs or either using **Ctrl-Page Up** or **Page Down** or **Alt-Number**. "Number" is tab number; you must use the number keys of the upper line of your keyboard, not that of keypad (Alt-shift necessary for some national keyboards).

This is a minimal setup. There are over a dozen other types of dialogs used by GIMP for various purposes, but users typically open them when they need them and close them when they are done. Knowledgeable users generally keep the Toolbox (with Tool Options) and Layers dialog open at all times. The Toolbox is essential to many GIMP operations. The Tool Options section is actually a separate dialog, shown docked to the Main Toolbox in the screenshot. Knowledgeable users almost always have it set up this way: it is very difficult to use tools effectively without being able to see how their options are set. The Layers dialog comes into play when you work with an image with multiple layers: after you advance beyond the most basic stages of GIMP expertise, this means *almost always*. And of course it helps to display the images you're editing on the screen; if you close the image window before saving your work, GIMP will ask you whether you want to close the file.

Note



If your GIMP layout is lost, your arrangement is easy to recover using Windows → Recently Closed Docks ; the Windows menu command is only available while an image is open. To add, close, or detach a tab from a dock, click  in the upper right corner of a dialog. This opens the Tab menu. Select Add Tab, Close Tab , or Detach Tab.

The following sections walk you through the components of each of the windows shown in the screenshot, explaining what they are and how they work. Once you have read them, plus the section describing the basic structure of GIMP images, you should have learned enough to use GIMP for a wide variety of basic image manipulations. You can then look through the rest of the manual at your leisure (or just experiment) to learn the almost limitless number of more subtle and specialized things that are possible. Have fun!

3.2.1 The Toolbox

Figure 3.4 Screenshot of the Toolbox



The Toolbox is the heart of GIMP. Here is a quick tour of what you will find there.

Tip

In the Toolbox, as in most parts of GIMP, moving the mouse over something and letting it rest for a moment, usually displays a “tooltip” that describes the thing. Short cut keys are also frequently shown in the tooltip. In many cases, you can hover the mouse over an item and press the **F1** key to get help about the thing that is underneath the mouse.

By default, only the Foreground-background icon is visible. You can add Brush-Pattern-Gradient icons and Active Image icon through Edit → Preferences → Toolbox: **Tools configuration**.

1. *Tool icons*: These icons are buttons which activate tools for a wide variety of purposes: selecting parts of images, painting an image, transforming an image, etc. Section 14.1 gives an overview of how to work with tools, and each tool is described systematically in the **Tools** chapter.

Note

Since GIMP-2.10.18, these icons can be tools groups. See Section 14.1.2.

2. *Foreground/Background colors*: The color areas here show you GIMP’s current foreground and background colors, which come into play in many operations. Clicking on either one of them brings up a color selector dialog that allows you to change to a different color. Clicking on the double-headed arrow swaps the two colors, and clicking on the small symbol in the lower left corner resets them to black and white.
3. *Brush/Pattern/Gradient*: The symbols here show you GIMP’s current selections for: the Paintbrush, used by all tools that allow you to paint on the image (“painting” includes operations like erasing and smudging, by the way); for the Pattern, which is used in filling selected areas of an image; and for the Gradient, which comes into play whenever an operation requires a smoothly varying range of colors. Clicking on any of these symbols brings up a dialog window that allows you to change it.
4. *Active Image*: In GIMP, you can work with many images at once, but at any given moment, only one image is the “active image”. Here you find a small iconic representation of the active image. Click the icon to display a dialog with a list of the currently open images, click an image in the dialog to make it active. Usually, you click an image window in multi-window mode, or an image tab in single-window mode, to make it the active image.

You can “Drop to an XDS file manager to save the image”. XDS is an acronym for “X Direct Save Protocol”: an additional feature for the X Window System graphical user interface for Unix-like operating systems.

Note

At every start, GIMP selects the brush, color, pattern you used when quitting your previous session because the Save input device settings on exit in **Preferences/Input Devices**, is checked by default. If you uncheck it, GIMP will use use a color, a brush and a pattern by default, always the same.

Tip



The Toolbox window displays “Wilber’s eyes” along the top of the dialog. You can click-drag-and-drop an image from a file browser into this area to open it. You can get rid of this logo by unchecking the Show GIMP logo option in the Toolbox page of Preferences.

3.2.2 Image Window

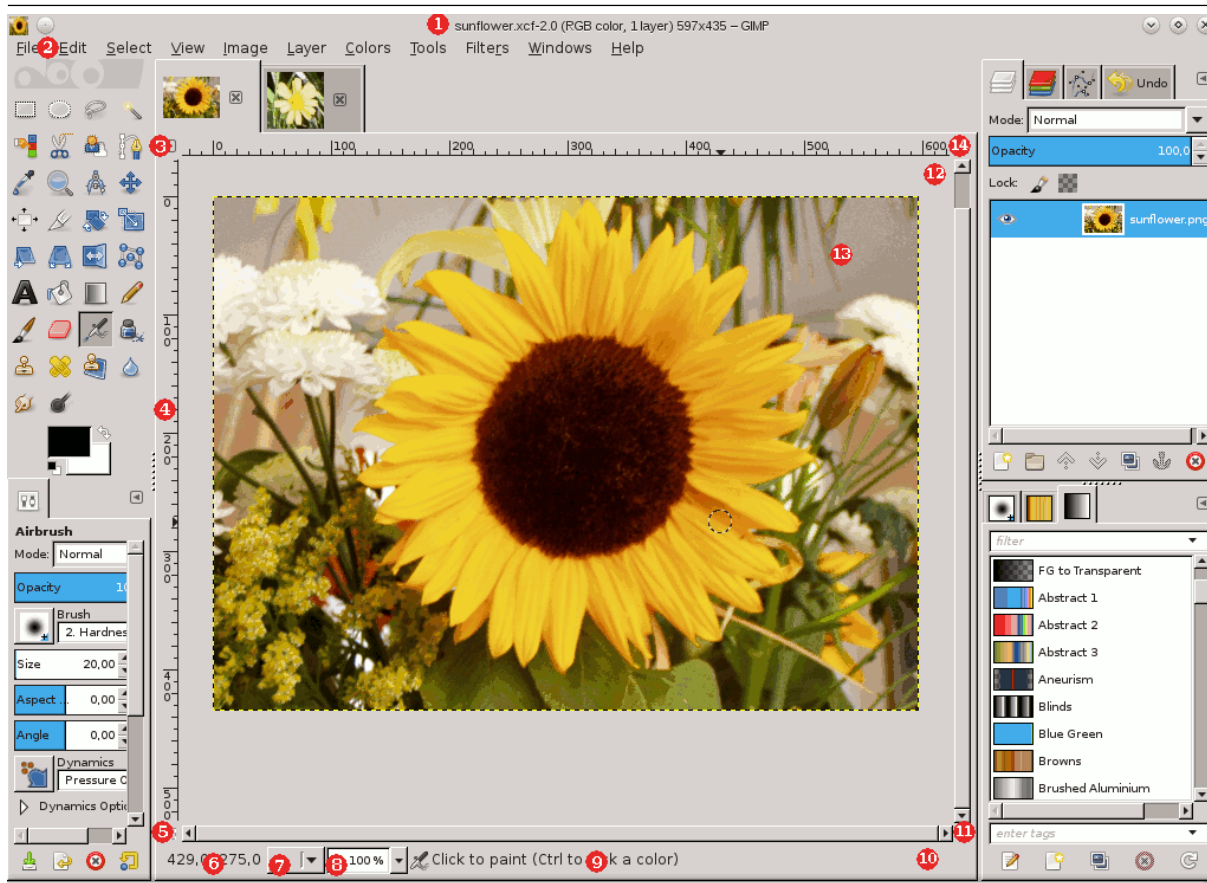
GIMP user interface is available in two modes: single-window mode (default), and multi-windows mode that you can get unchecking the Windows → >Single-Window Mode option.

When you start GIMP without any image open, the image window seems to be absent in single-window mode, while, in multi-window mode, an image window exists, even if no image is open.

We will begin with a brief description of the components that are present by default in an ordinary image window. Some of the components can be removed by using commands in the **View** menu.

Figure 3.5 The Image Window in Multi-Window Mode



Figure 3.6 The Image Area in Single-Window Mode**Note**

Despite *Single-window Mode*, we will use “image window” for “image area”.

1. *Title Bar*: The Title Bar in an image window without an image displays “GNU Image Manipulating Program”. An image window with an image displays the image name and its specifications in the title bar according to the settings in [Preference Dialog](#). The Title Bar is provided by the operating system, not by GIMP, so its appearance is likely to vary with the operating system, window manager, and/or theme.

If you have opened a non-xcf image, it is “(imported)” as a .xcf file and its original name appears in the status bar at the bottom of the image window.

When an image is modified, an asterisk appears in front of title.

2. *Image Menu*: Directly below the Title Bar appears the Menu bar (unless it has been suppressed). The Image Menu provides access to nearly every operation you can perform on an image. You can also right-click on an image to display a pop-up image menu,¹ or by left-clicking on the little “arrow-head” symbol in the upper left corner, called *Menu Button*, described just below. Many menu commands are also associated with keyboard *shortcuts* as shown in the menu. You can define your own custom shortcuts for menu actions, if you enable [Use Dynamic Keyboard Shortcuts](#) in the Preferences dialog.

¹Users with an Apple Macintosh and a one button mouse can use Ctrl-Mouse Button instead.

3. *Menu Button*: Click the Menu Button to display the Image Menu in a column,(essential in full screen mode). If you like to use keyboard shortcuts, use Shift-F10 to open the menu.
4. *Ruler*: In the default layout, rulers are shown above and to the left of the image. Use the rulers to determine coordinates within the image. The default unit for rulers is pixels; use the settings described below to use a unit other than pixels.

One of the most important uses of rulers is to create *guides*. Click and drag a ruler into the image to create a guide. A guide is a line that helps you accurately position things—or verify that another line is truly horizontal or vertical. Using the Move tool, you can click and drag a guide. Drag a guide out of the image to delete it; you can always drag another guide into the image. You can even use multiple guides at the same time.

In ruler area, the mouse pointer position is marked with two small arrow-heads pointing vertically and horizontally.

5. *QuickMask Toggle*: The small button in the lower left corner of the image toggles the Quick Mask on and off. When the Quick Mask is on, the button is outlined in red. See [QuickMask](#) for more details on this highly useful tool.
6. *Pointer Coordinates*: When the pointer (mouse cursor, if you are using a mouse) is within the image boundaries, the rectangular area in the lower left corner of the window displays the current pointer coordinates. The units are the same as for the rulers.
7. *Units Menu*: Use the Units Menu to change the units used for rulers and several other purposes. The default unit is pixels, but you can quickly change to inches, cm, or several other possibilities using this menu. Note that the setting of “Dot for dot” in the View menu affects how the display is scaled: see [Dot for Dot](#) for more information.
8. *Zoom Button*: There are a number of ways to zoom the image in or out, but the Zoom Button is perhaps the simplest. You can directly enter a zoom level in the text box for precise control.
9. *Status Area*: The Status Area is at the bottom of the image window. By default, the Status Area displays the original name of the image.xcf file, and the amount of system memory used by the image. Please use Edit → Preferences → Image Windows → Title & Status to customize the information displayed in the Status Area. During time-consuming operations, the status area temporarily shows the running operation and how complete the operation is.

Note



Note that the memory used by the image is very different from the image file size. For instance, a 70Kb .PNG image may occupy 246Kb in RAM when displayed. There are two primary reasons the difference in memory usage. First, a .PNG file is compressed format, and the image is reconstituted in RAM in uncompressed form. Second, GIMP uses extra memory, and copies of the image, for use by the Undo command.

10. *Cancel Button*: During complex time-consuming operations, usually a plug-in, a Cancel button temporarily appears in the lower right corner of the window. Use the Cancel button to stop the operation.

Note



A few plug-ins respond badly to being canceled, sometimes leaving corrupted pieces of images behind.

11. *Navigation Control*: This is a small cross-shaped button at the lower right corner of the image display. Click and hold (do not release the mouse button) on the navigation control to display the Navigation Preview. The Navigation Preview has a miniature view of the image with the displayed area outlined. Use the Navigation Preview to quickly pan to a different part of the image—move the mouse while keeping the button pressed. The Navigation Window is often the most convenient way to quickly navigate around a large image with only a small portion displayed. (See [Navigation Dialog](#) for other ways to access the Navigation Window). (If your mouse has a middle-button, click-drag with it to pan across the image).
12. *Inactive Padding Area*: When the image dimensions are smaller than the image window, this padding area separates the active image display and the inactive padding area, so you're able to distinguish between them. You cannot apply any Filters or Operations in general to the inactive area.
13. *Image Display*: The most important part of the image window is, of course, the image display or canvas. It occupies the central area of the window, surrounded by a yellow dotted line showing the image boundary, against a neutral gray background. You can change the zoom level of the image display in a variety of ways, including the Zoom setting described below.
14. *Image Window Resize Toggle*: Without enabling this feature, if you change the size of the image window by click-and-dragging border limits, the image size and zoom does not change. If you make the window larger, for example, then you will see more of the image. If this button is pressed, however, the image resizes when the window resizes so that (mostly) the same portion of the image is displayed before and after the window is resized.

Tip



Drag and drop an image into the Toolbox window from a file browser to open the image in its own Image window or tab.

Dragging an image file into the Layer dialog adds it to the image as a new layer.

Image size and image window size can be different. You can make image fit window, and vice versa, using two keyboard shortcuts:

- Ctrl-J: this command keeps the zoom level; it adapts window size to image size. The Shrink Wrap command does the same.
- Ctrl-Shift-J: this command modifies the zoom level to adapt the image display to the window.

3.2.3 Dialogs and Docking

3.2.3.1 Organizing Dialogs

GIMP has great flexibility for arranging dialog on your screen. A “dialog” is a moving window which contains options for a tool or is dedicated to a special task. A “dock” is a container which can hold a collection of persistent dialogs, such as the Tool Options dialog, Brushes dialog, Palette dialog, etc. Docks cannot, however, hold non-persistent dialogs such as the Preferences dialog or an Image window.

GIMP has three default docks:

- the Tool Options dock under the Toolbox in the left panel,
- the Layers, Channels, Paths and Undo dock in the upper part of the right panel,
- the Brushes, Patterns and Gradients dock in the lower part of the right panel.

In these docks, each dialog is in its own tab.

In multi-window mode, the Toolbox is a *utility window* and not a dock. In single-window mode, it belongs to the single window.

Use Windows → Dockable Dialogs to view a list of dockable dialogs. Select a dockable dialog from the list to view the dialog. If the dialog is available in a dock, then it is made visible. If the dialog is not in a dock, the behavior is different in multi and single window modes:

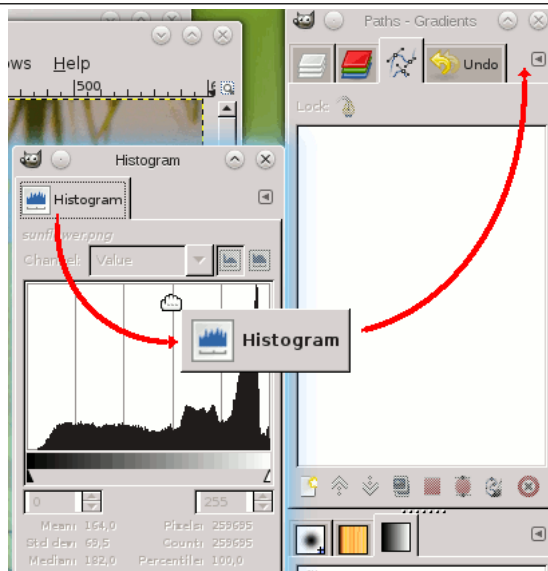
- In multi-window mode, a new window, containing the dialog, appears on the screen.
- In single-window mode, the dialog is automatically docked to the Layers-Undo dock as a tab.

You can click-and-drag a tab and drop it in the wanted place:

- either in the tab bar of a dock, to integrate it in the dialog group,
- or on a docking bar that appears as a blue line when the mouse pointer goes over a dock border, to anchor the dialog to the dock.

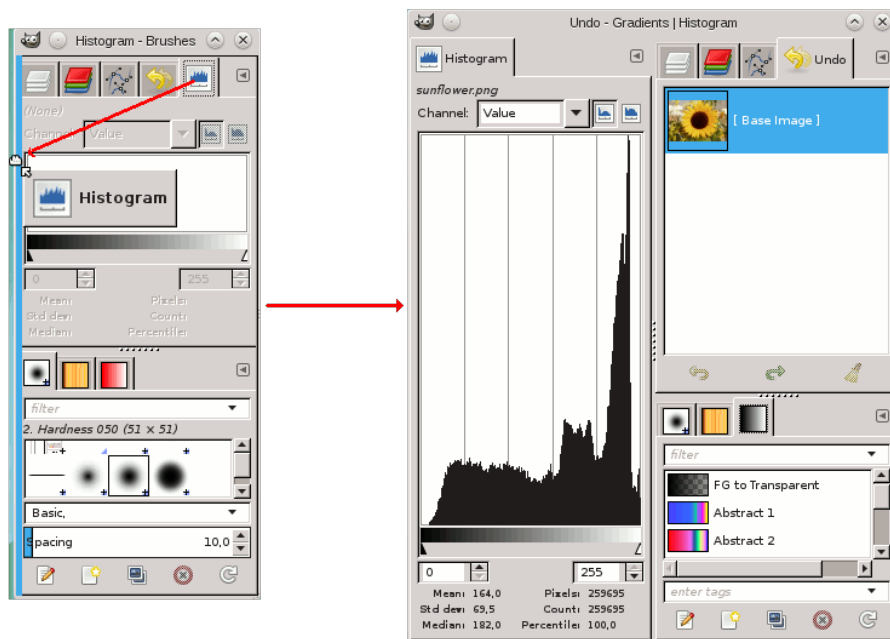
In multi-window mode, you can also click on the dialog title and drag it to the wanted place.

Figure 3.7 Integrating a new dialog in a dialog group



Here, in multi-window mode, the Histogram dialog was dragged to the tab bar of the Layers-Undo dock.

More simple: the **Add tab** command in the Tab menu Section [3.2.3.2](#).

Figure 3.8 Anchoring a dialog to a dock border

The Histogram dialog dragged to the left vertical docking bar of the right panel and the result: the dialog anchored to the left border of the right panel. This dialog now belongs to the right panel.

So, you can arrange dialogs in a multi-column display, interesting if you work with two screens, one for dialogs, the other for images.

Tip

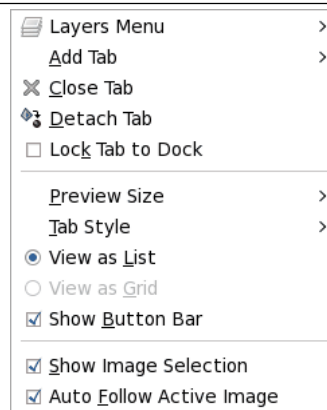


Press the **Tab** key in an Image window to toggle the visibility of the docks. This is useful if the docks hide a portion of the image Window. You can quickly hide all the docks, do your work, then display all the docks again. Pressing the **Tab** key inside a dock to navigate through the dock.

3.2.3.2 Tab Menu

Figure 3.9 A dialog in a dock, with the Tab menu button highlighted.

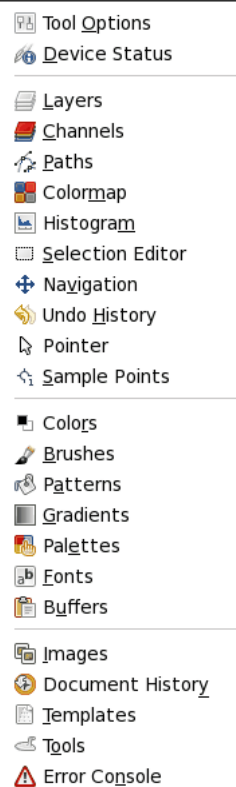
In each dialog, you can access a special menu of tab-related operations by pressing the Tab Menu button, as highlighted in the figure above. Exactly which commands are shown in the menu depends on the active dialog, but they always include operations for creating new tabs, closing or detaching tabs.

Figure 3.10 The Tab menu of the Layers dialog.

The Tab menu gives you access to the following commands:

Context Menu At the top of each Tab menu, an entry opens the dialog’s context menu, which contains operations specific to that particular type of dialog. For example, the context menu for the Layers tab is Layers Menu, which contains a set of operations for manipulating layers.

Add Tab Add Tab opens into a submenu allowing you to add a large variety of dockable dialogs as new tabs.

Figure 3.11 “Add tab” sub-menu

Close Tab Close the dialog. Closing the last dialog in a dock causes the dock itself to close.

Detach Tab Detach the dialog from the dock, creating a new dock with the detached dialog as its only member. It has the same effect as dragging the tab out of the dock and releasing it at a location where it cannot be docked.

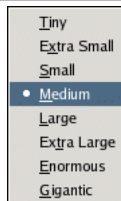
It’s a way to create a paradoxical new window in single-window mode!

If the tab is **locked**, this menu item is insensitive and grayed out.

Lock Tab to Dock Prevent the dialog from being moved or detached. When activated, Detach Tab is insensitive and grayed out.

Preview Size

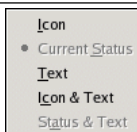
Figure 3.12 Preview Size submenu of a Tab menu.



Many, but not all, dialogs have Tab menus containing a Preview Size option, which opens into a submenu giving a list of sizes for the items in the dialog (see the figure above). For example, the Brushes dialog shows pictures of all available brushes: the Preview Size determines how large the pictures are. The default is Medium.

Tab Style

Figure 3.13 Tab Style submenu of a Tab menu.



Tab Style opens a submenu allowing you to choose the appearance of the tabs at the top (see the figure above). There are five choices, not all are available for every dialog:

Icon Use an icon to represent the dialog type.

Current Status Is only available for dialogs that allows you to select something, such as a brush, pattern, gradient, etc. Current Status shows a representation of the currently selected item in the tab top.

Text Use text to display the dialog type.

Icon and Text Using both an icon and text results in wider tabs.

Status and Text Show the currently selected item and text with the dialog type.

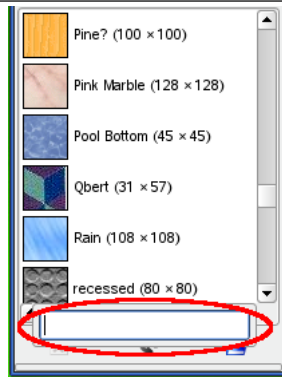
Automatic Default option: adapts style according to the available place in the group (text style uses much place and is not always possible).

View as List; View as Grid These entries are shown in dialogs that allow you to select an item from a set: brushes, patterns, fonts, etc. You can choose to view the items as a vertical list, with the name of each beside it, or as a grid, with representations of the items but no names. Each has its advantages: viewing as a list gives you more information, but viewing as a grid allows you to see more possibilities at once. The default for this varies across dialogs: for brushes and patterns, the default is a grid; for most other things, the default is a list.

When the tree-view is View as List, you can use tags. Please see Section [15.3.6](#).

You can also use a list search field:

Figure 3.14 The list search field.



Use *Ctrl-F* to open the list search field. An item must be selected for this command to be effective.

The list search field automatically closes after five seconds if you do nothing.

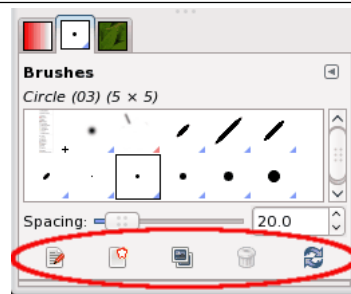
Note



The search field shortcut is also available for the tree-view you get in the “Brush”, “Font” or “Pattern” option of several tools.

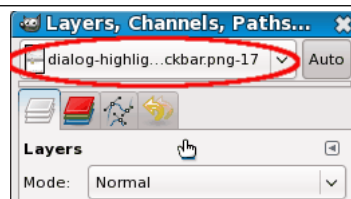
Show Button Bar Some dialogs display a button bar on the bottom of the dialog; for example, the Patterns, Brushes, Gradients, and Images dialogs. This is a toggle. If it is checked, then the Button Bar is displayed.

Figure 3.15 Button Bar on the Brushes dialog.



Show Image Selection This option is available in multi-window mode only. This is a toggle. If it is checked, then an Image Menu is shown at the top of the dock:

Figure 3.16 A dock with an Image Menu highlighted.



It is not available for dialogs docked below the Toolbox. This option is interesting only if you have several open images on your screen.

Auto Follow Active Image This option is available in multi-window mode only. This option is also interesting only if you have several images open on your screen. Then, the information displayed in a dock is always that of the selected image in the Image Selection drop-down list. If the Auto Follow Active Image is disabled, the image can be selected only in the Image Selection. If enabled, you can also select it by activating the image directly (clicking on its title bar).

3.3 Undoing

Almost anything you do to an image in GIMP can be undone. You can undo the most recent action by choosing Edit → Undo from the image menu, but this is done so frequently that you really should memorize the keyboard shortcut, Ctrl-Z.

Undoing can itself be undone. After having undone an action, you can *redo* it by choosing Edit → Redo from the image menu, or use the keyboard shortcut, Ctrl-Y. It is often helpful to judge the effect of an action by repeatedly undoing and redoing it. This is usually very quick, and does not consume any extra resources or alter the undo history, so there is never any harm in it.

Caution



If you undo one or more actions and then operate on the image in any way except by using Undo or Redo, it will no longer be possible to redo those actions: they are lost forever. The solution to this, if it creates a problem for you, is to duplicate the image and then test on the copy. (Do *Not* test the original, because the undo/redo history is not copied when you duplicate an image.)

If you often find yourself undoing and redoing many steps at a time, it may be more convenient to work with the **Undo History dialog**, a dockable dialog that shows you a small sketch of each point in the Undo History, allowing you to go back or forward to that point by clicking.

Undo is performed on an image-specific basis: the "Undo History" is one of the components of an image. GIMP allocates a certain amount of memory to each image for this purpose. You can customize your Preferences to increase or decrease the amount, using the **System Resources** page of the Preferences dialog. There are two important variables: the *minimal number of undo levels*, which GIMP will maintain regardless of how much memory they consume, and the *maximum undo memory*, beyond which GIMP will begin to delete the oldest items from the Undo History.

Note



Even though the Undo History is a component of an image, it is not saved when you save the image using GIMP's native XCF format, which preserves every other image property. When the image is reopened, it will have an empty Undo History.

GIMP's implementation of Undo is rather sophisticated. Many operations require very little Undo memory (e.g., changing visibility of a layer), so you can perform long sequences of them before they drop out of the Undo History. Some operations, such as changing layer visibility, are *compressed*, so that doing them several times in a row produces only a single point in the Undo History. However, there are other operations that may consume a lot of undo memory. Most filters are implemented by plug-ins, so the GIMP core has no efficient way of knowing what changed. As such, there is no way to implement Undo except by memorizing the entire contents of the affected layer before and after the operation. You might only be able to perform a few such operations before they drop out of the Undo History.

3.3.1 Things That Cannot be Undone

Most actions that alter an image can be undone. Actions that do not alter the image generally cannot be undone. Examples include saving the image to a file, duplicating the image, copying part of the image to the clipboard, etc. It also includes most actions that affect the image display without altering

the underlying image data. The most important example is zooming. There are, however, exceptions: toggling QuickMask on or off can be undone, even though it does not alter the image data.

There are a few important actions that do alter an image but cannot be undone:

Closing the image The Undo History is a component of the image, so when the image is closed and all of its resources are freed, the Undo History is gone. Because of this, unless the image has not been modified since the last time it was saved, GIMP always asks you to confirm that you really want to close the image.

Reverting the image “Reverting” means reloading the image from the file. GIMP actually implements this by closing the image and creating a new image, so the Undo History is lost as a consequence. Because of this, if the image is unclean, GIMP asks you to confirm that you really want to revert the image.

“Pieces” of actions Some tools require you to perform a complex series of manipulations before they take effect, but only allow you to undo the whole thing rather than the individual elements. For example, the Intelligent Scissors require you to create a closed path by clicking at multiple points in the image, and then clicking inside the path to create a selection. You cannot undo the individual clicks: undoing after you are finished takes you all the way back to the starting point. For another example, when you are working with the Text tool, you cannot undo individual letters, font changes, etc.: undoing after you are finished removes the newly created text layer.

Filters, and other actions performed by plugins or scripts, can be undone just like actions implemented by the GIMP core, but this requires them to make correct use of GIMP’s Undo functions. If the code is not correct, a plugin can potentially corrupt the Undo History, so that not only the plugin but also previous actions can no longer properly be undone. The plugins and scripts distributed with GIMP are all believed to be set up correctly, but obviously no guarantees can be given for plugins you obtain from other sources. Also, even if the code is correct, canceling a plugin while it is running may corrupt the Undo History, so it is best to avoid this unless you have accidentally done something whose consequences are going to be very harmful.

3.4 Common Tasks

This tutorial is based on text Copyright © 2004 Carol Spears. The original tutorial can be found online: [[TUT02](#)].

3.4.1 Intention

GIMP is a powerful image editing program with many options and tools. However, it is also well suited for smaller tasks. The following tutorials are meant for those who want to achieve these common tasks without having to learn all the intricacies of GIMP and computer graphics in general.

Hopefully, these tutorials will not only help you with your current task, but also get you ready to learn more complex tools and methods later, when you have the time and inspiration.

All you need to know to start this tutorial, is how to find and open your image. (File → Open from the Image window).

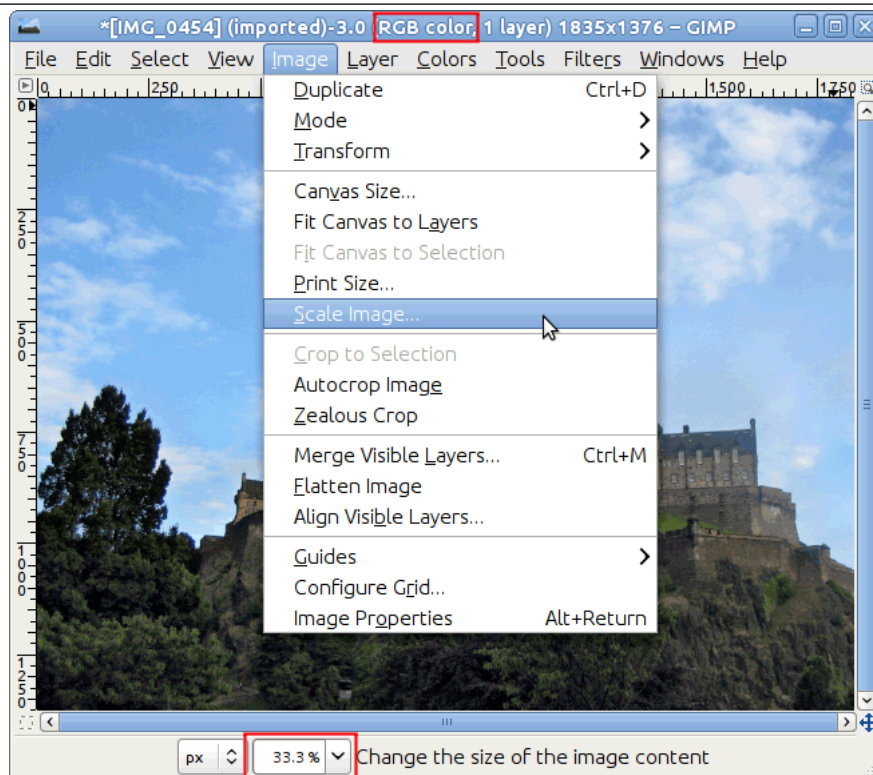
3.4.2 Change the Size of an Image for the screen

You have a huge image, possibly from a digital camera, and you want to resize it so that it displays nicely on a web page, online board or email message.

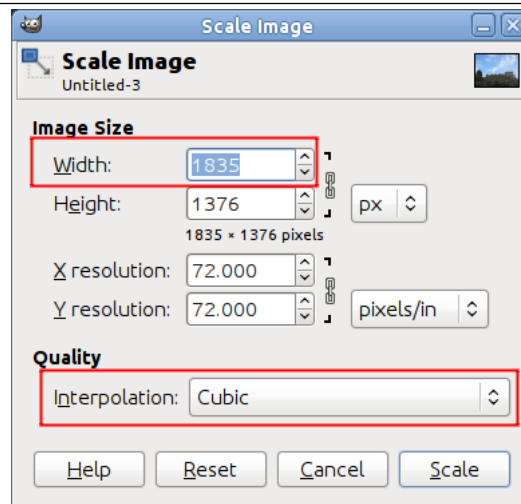
Figure 3.17 Example Image for Scaling

The first thing that you might notice after opening the image, is that GIMP opens the image at a logical size for viewing. If your image is very large, like the sample image, GIMP sets the zoom so that it displays nicely on the screen. The zoom level is shown in the status area at the bottom of the Image window. This does not change the actual image.

The other thing to look at in the title-bar is the mode. If the mode shows as RGB in the title bar, you are fine. If the mode says Indexed or Grayscale, read the Section 3.4.7.

Figure 3.18 GIMP Used for Image Scaling

Use Image → Scale Image to open the “Scale Image” dialog. You can right click on the image to open the menu, or use the menu along the top of the Image window. Notice that the “Scale Image” menu item contains three dots, which is a hint that a dialog will be opened.

Figure 3.19 Dialog for Image Scaling in Pixels

The unit of size for the purpose of displaying an image on a screen is the pixel. You can see the dialog has two sections: one for width and height and another for resolution. Resolution applies to printing only and has no effect on the image's size when it is displayed on a monitor or a mobile device. The reason is that different devices have different pixels sizes and so, an image that displays on one device (such as a smartphone) with a certain physical size, might display on other devices (such as an LCD projector) in another size altogether. For the purpose of displaying an image on a screen, you can ignore the resolution parameter. For the same reason, do not use any size unit other than the pixel in the height / width fields.

If you know the desired width, enter it in the dialog at the top where it says Width. This is shown in the figure above. If you don't have such a number in mind, choose an appropriate width for the desired use. Common screen sizes range between 320 pixels for simpler phones, 1024 pixels for a netbook, 1440 for a wide-screen PC display and 1920 pixels for an HD screen. for the purpose of displaying an image on-line, a width of 600 to 800 pixels offers a good compromise.

When you change one of the image's dimensions, GIMP changes the other dimension proportionally. To change the other dimension, see Section 3.4.5. Bear in mind that when you change the two dimensions arbitrarily, the image might become stretched or squashed.

3.4.3 Change the Size of an Image for print

As discussed before, pixels don't have a set size in the real world. When you set out to print an image on paper, GIMP needs to know how big each pixels is. We use a parameter called resolution to set the ratio between pixels and real-world units such as inches.

By default, most images open with the resolution set to 72. This number was chosen for historical reasons as it was the resolution of screens in the past, and means that when printed, every pixel is 1/72 of an inch wide. When printing images are taken with modern digital cameras, this produces very large but chunky images with visible pixels. What we want to do is tell GIMP to print it with the size we have in mind, but not alter the pixel data so as not to lose quality.

To change the print size use Image → Print Size to open the "Print Size" dialog. Select a size unit you are comfortable with, such as "inches". Set one dimension, and let GIMP change the other one proportionally. Now examine the change in resolution. If the resolution is 300 pixels per Inch or over, the printed image's quality will be very high and pixels will not be noticeable. With a resolution of between 200 and 150 ppi, pixels will be somewhat noticeable, but the image will be fine as long as its not inspected too closely. Values lower than 100 are visibly coarse and should only be used for material that is seen from a distance, such as signs or large posters.

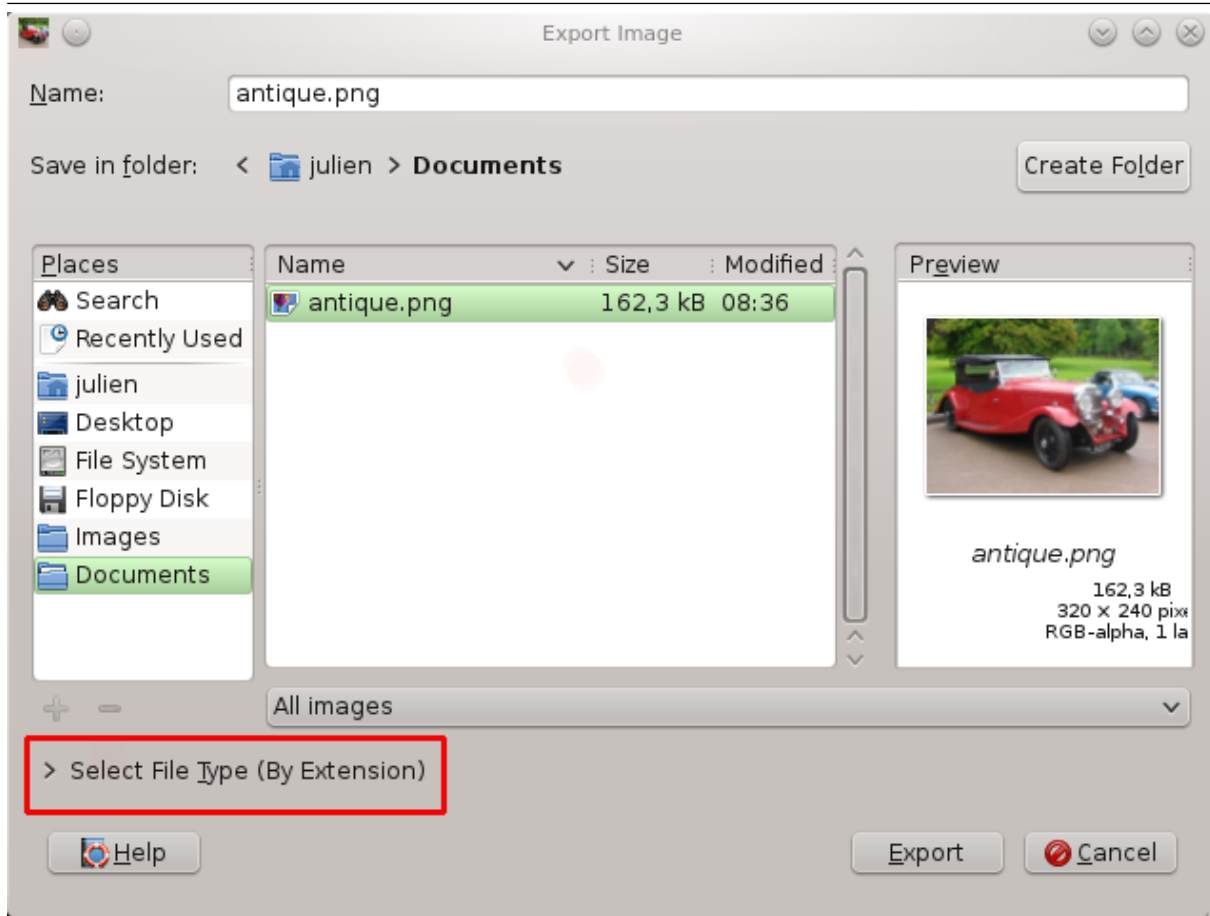
Figure 3.20 Dialog for Setting Print Size

3.4.4 Compressing Images

Figure 3.21 Example Image for JPEG Saving

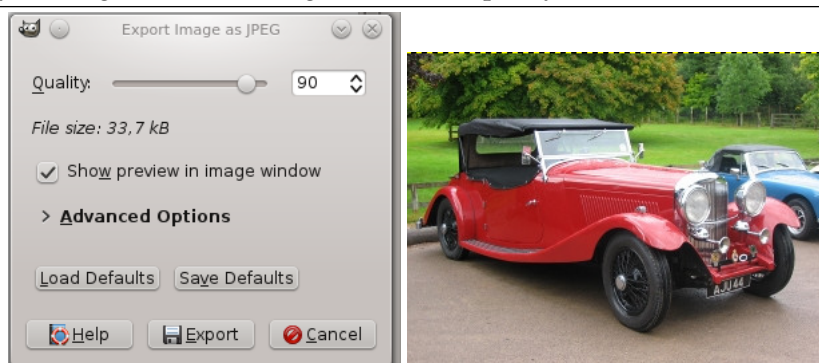
If you have images that take up a large space on disk, you can reduce that space even without changing the image dimensions. The best image compression is achieved by using the JPG format, but even if the image is already in this format, you can usually still make it take up less space, as the JPG format has an adaptive compression scheme that allows saving in varying levels of compression. The trade-off is that the less space an image takes, the more detail from the original image you lose. You should also be aware that repeated saving in the JPG format causes more and more image degradation.

Since GIMP-2.8, images are loaded and saved as .XCF files. Your JPG image has been loaded as XCF. GIMP offers you to Overwrite image-name.jpg or File → Export As to open the “Export Image” dialog.

Figure 3.22 “Export Image” Dialog

The dialog opens with the file name already typed in the Name box, with the default.png extension. Delete the existing extension and type JPG instead, and GIMP will determine the file type from the file extension. Use the file extension list, red circled in the figure above, to see the types supported by GIMP. The supported extensions change depending on your installed libraries. If GIMP complains, or if “JPEG” is grayed out in the Extensions menu, cancel out of everything and step through the Section 3.4.7. Once you have done this, click Save. This opens the “Export Image as JPEG” dialog that contains the quality control.

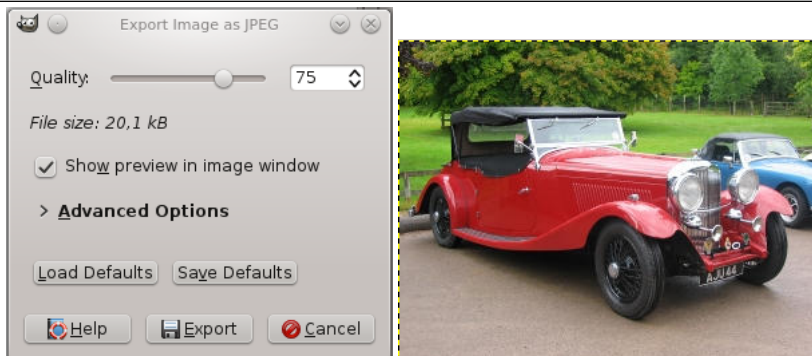
The “Export Image as JPEG” dialog uses default values that reduce size in memory while retaining good visual quality; this is the safest and quickest thing to do.

Figure 3.23 “Export Image as JPEG” dialog with default quality

Reduce the image Quality to make the image even smaller. Reduced quality degrades the image, so be certain to check “Show preview in image window” to visually gauge the degradation. A Quality setting of 10 produces a very poor quality image that uses very little disk space. The figure below shows a more

reasonable image. A quality of 75 produces a reasonable image using much less disk space, which will, in turn, load much faster on a web page. Although the image is somewhat degraded, it is acceptable for the intended purpose.

Figure 3.24 “Export Image as JPEG” dialog with quality 75

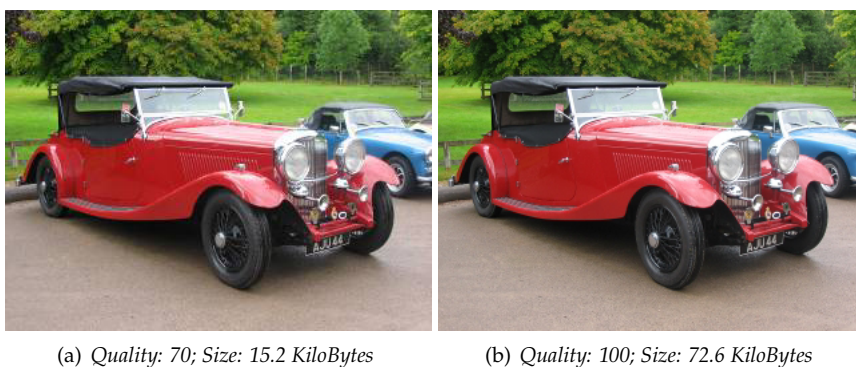


Finally, here is a comparison of the same picture with varying degrees of compression:

Figure 3.25 Example for High JPEG Compression

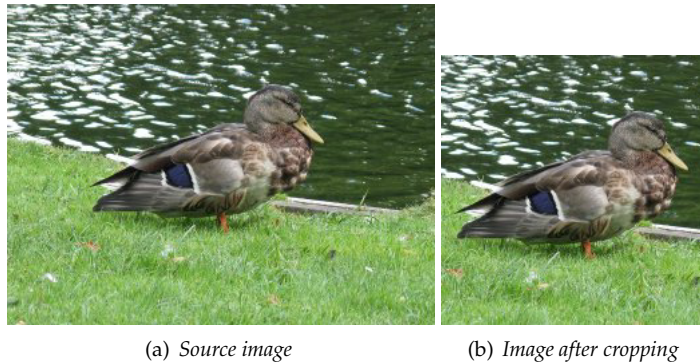


Figure 3.26 Example for Moderate JPEG Compression



3.4.5 Crop An Image

Figure 3.27 Example Image for Cropping



There are many reasons to crop an image; for example, fitting an image to fill a frame, removing a portion of the background to emphasize the subject, etc. There are two methods to activate the crop tool. Click


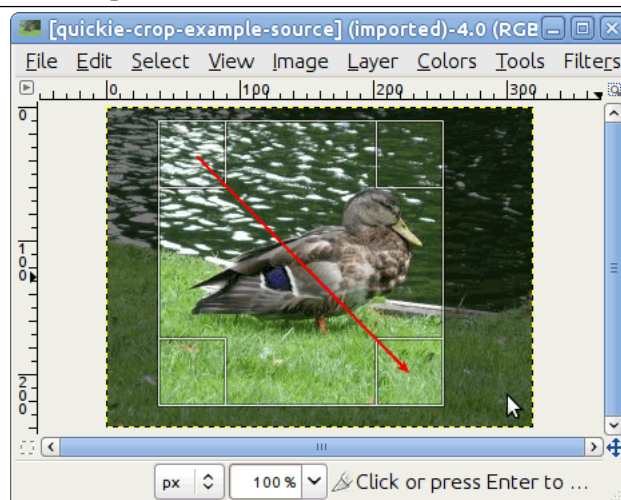
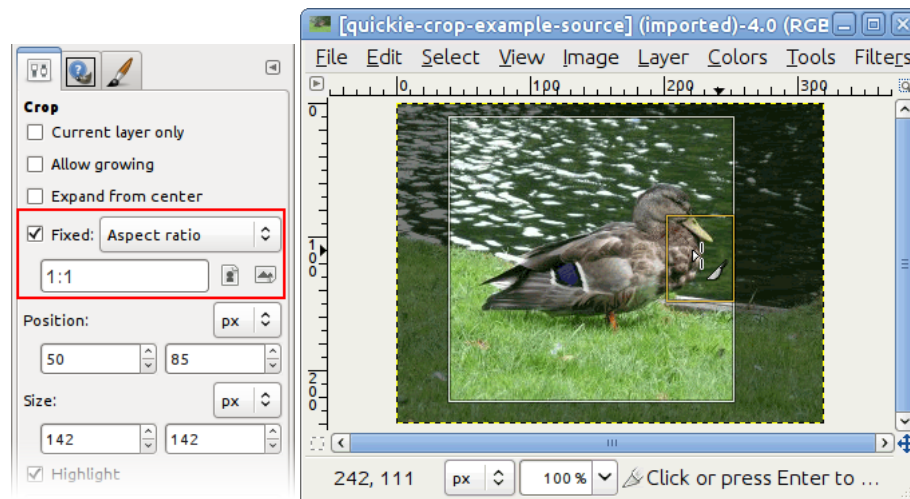
the  button in the Toolbox, or use Tools → Transform Tools → Crop in the image window. This changes the cursor and allow you to click and drag a rectangular shape. The button in the toolbox is the easiest way to get to any of the tools.

Figure 3.28 Select a Region to Crop



Click on one corner of the desired crop area and drag your mouse to create the crop rectangle. You don't have to be accurate as you can change the exact shape of the rectangle later.

Figure 3.29 Dialog for Cropping



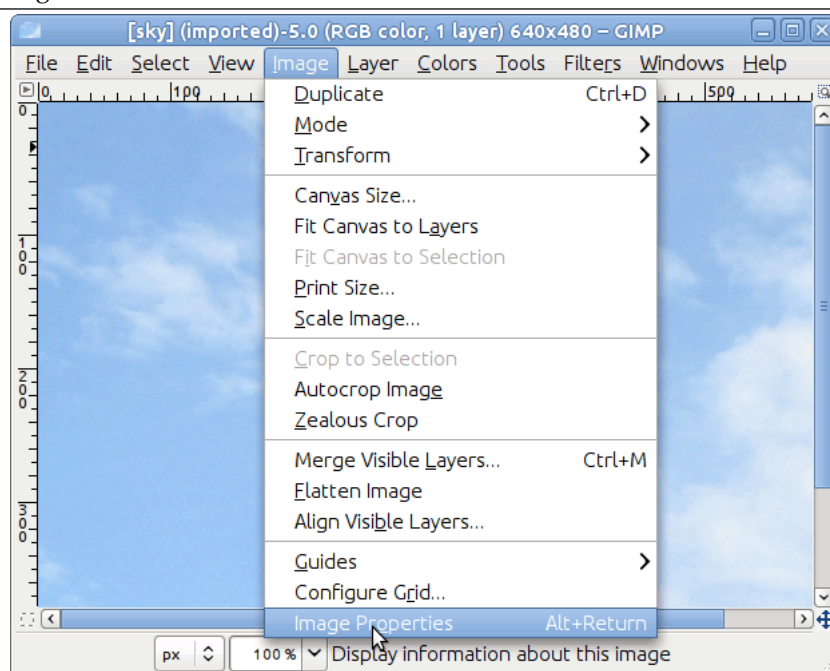
After completing the click and drag motion, a rectangle with special regions is shown on the canvas. As the cursor is moved over the different areas of the selected crop area, the cursor changes. You can then drag the rectangle's corners or edges to change the dimensions of the selected area. As shown in the figure above, as the crop area is resized, the dimensions and ratio are shown in the status bar. Double-click inside the rectangle or press **Enter** to complete cropping. See Section 14.4.4 for more information on cropping in GIMP.

If you would like to crop the image in a specific aspect ratio, such as a square, make sure the tool options are visible (Windows → Dockable Dialogs → Tool Options). In the Tool Options dockable, check the mark next to Fixed and make sure the drop-down box next to it is set to Aspect Ratio. You can now type the desired aspect ratio on the text box below, such as "1:1".

You also have controls to change the aspect from landscape to portrait. After you set the aspect ratio, drag one of the corners of the crop rectangle to update it. The rectangle changes to the chosen ratio, and when you drag it should maintain that ratio.

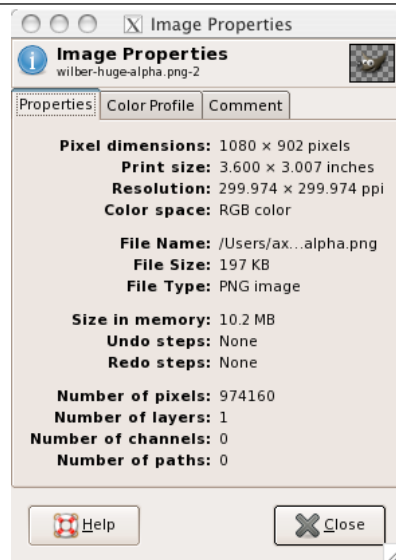
3.4.6 Find Info About Your Image

Figure 3.30 Finding Info



When you need to find out information about your image, Use Image → Image Properties to open the “Image Properties” dialog, which contains information about the image size, resolution, mode and much more.

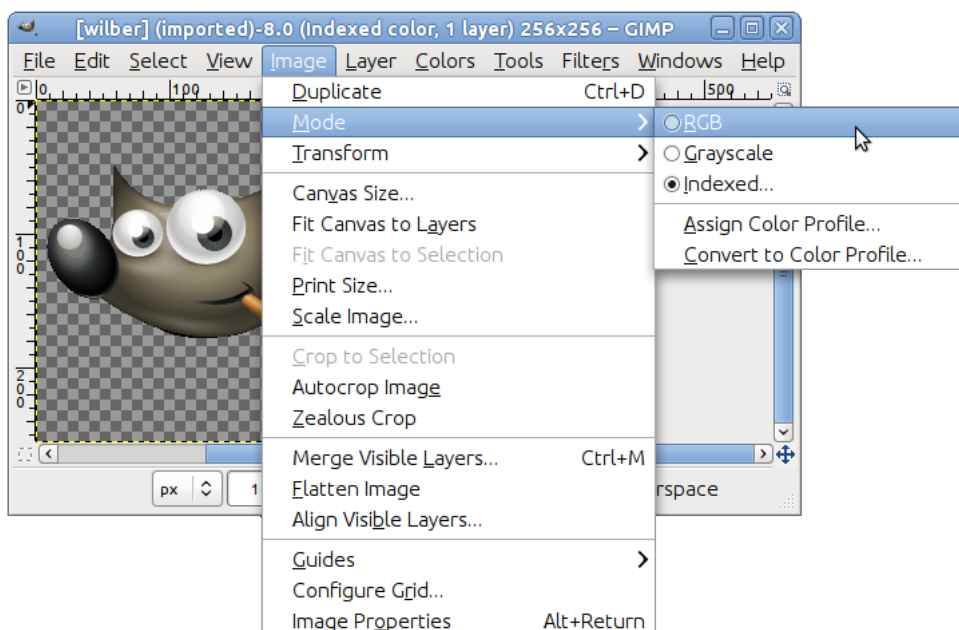
Figure 3.31 “Image Properties” Dialog



3.4.7 Change the Mode

As with anything else, images come in different kinds and serve different purposes. Sometimes, a small size is important (for web sites) and at other times, retaining a high color depth (e.g., a family portrait) is what you want. GIMP can handle all of this, and more, primarily by converting between three fundamental modes, as seen in this menu. In order to switch your image to one of these modes, you open it and follow that menu and click the mode you want.

Figure 3.32 Dialog for changing the mode

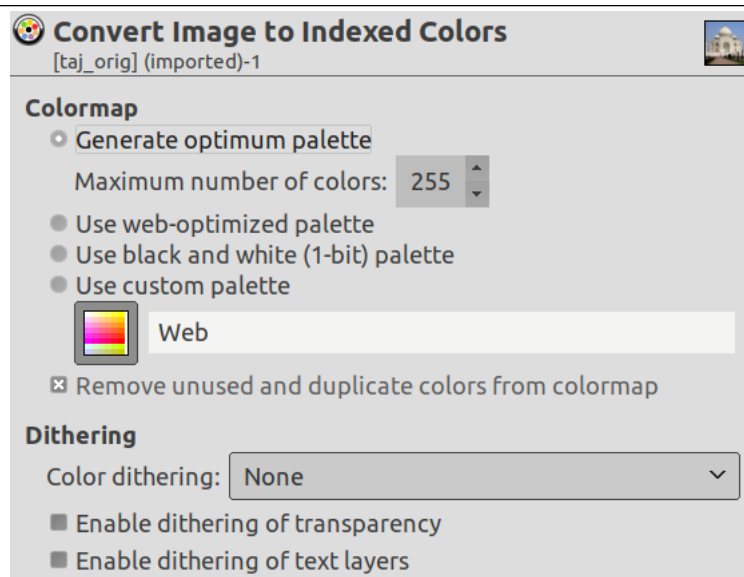


RGB- This is the default mode, used for high-quality images, and able to display millions of colors. This is also the mode for most of your image work including scaling, cropping, and even flipping. In RGB mode, each pixel consists of three different components: R->Red, G->Green, B->Blue. Each of these

in turn can have an intensity value of 0-255. What you see at every pixel is an additive combination of these three components.

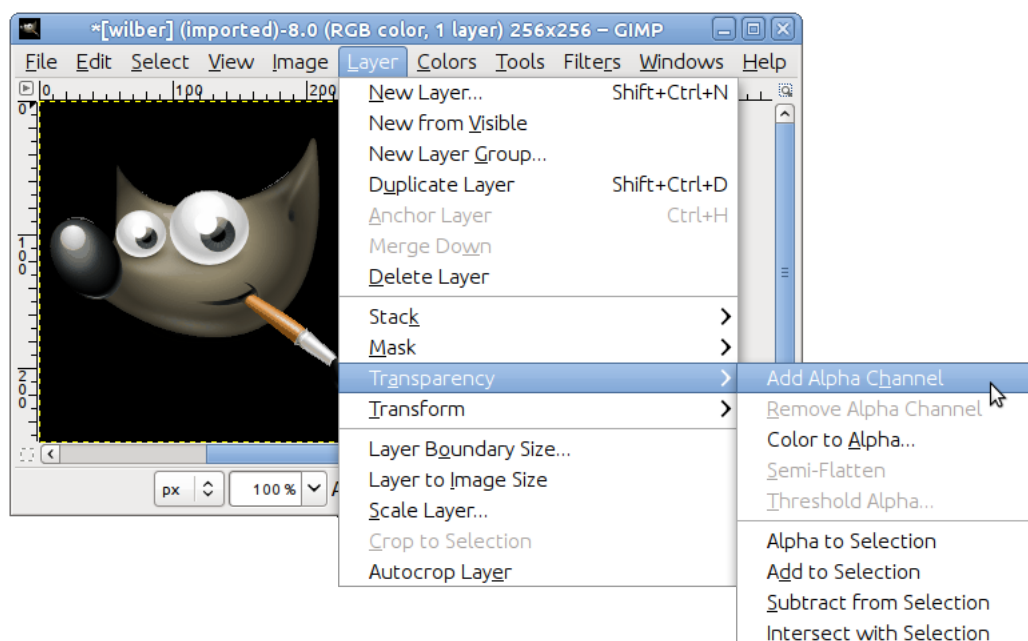
Indexed- This is the mode usually used when file size is of concern, or when you are working with images with few colors. It involves using a fixed number of colors (256 or less) for the entire image to represent colors. By default, when you change an image to a palleted image, GIMP generates an “optimum palette” to best represent your image.

Figure 3.33 Dialog “Convert Image to Indexed Colors”



As you might expect, since the information needed to represent the color at each pixel is less, the file size is smaller. However, sometimes, there are options in the various menus that are grayed-out for no apparent reason. This usually means that the filter or option cannot be applied when your image is in its current mode. Changing the mode to RGB, as outlined above, should solve this issue. If RGB mode doesn't work either, perhaps the option you're trying requires your layer to have the ability to be transparent. This can be done just as easily via Layer → Transparency → Add Alpha Channel.

Figure 3.34 Add Alpha Channel



Grayscale- Grayscale images have only shades of gray. This mode has some specific uses and takes less space on the hard drive in some formats, but is not recommended for general use as reading it is not supported by many applications.

There is no need to convert an image to a specific mode before saving it in your favorite format, as GIMP is smart enough to properly export the image.

3.4.8 Flip An Image


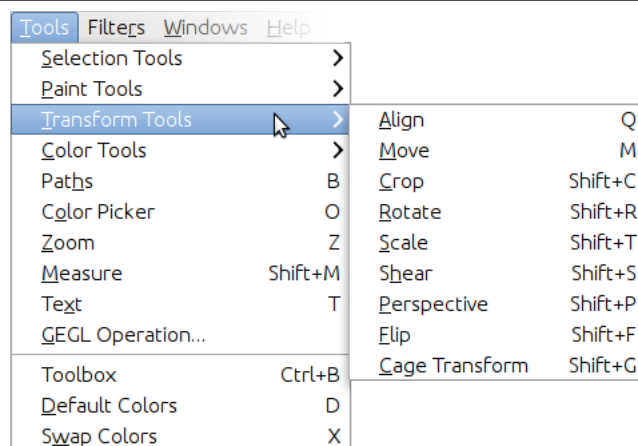
Use this option when you need the person in the photo looking in the other direction, or you need the top of the image to be the bottom. Use Tools → Transform Tools → Flip , or use the  button on the toolbox. After selecting the flip tool from the toolbox, click inside the canvas. Controls in the Tool Options dockable let you switch between Horizontal and Vertical modes.

Figure 3.35 Dialog “Flip an Image”



After selecting the flip tool from the toolbox, click inside the canvas. The tool flips the image horizontally. Use the options dialog to switch between horizontal and vertical. If it is not already displayed in the dock under the toolbox, double click the toolbox button. You can also use the **Ctrl** key to switch between horizontal and vertical.

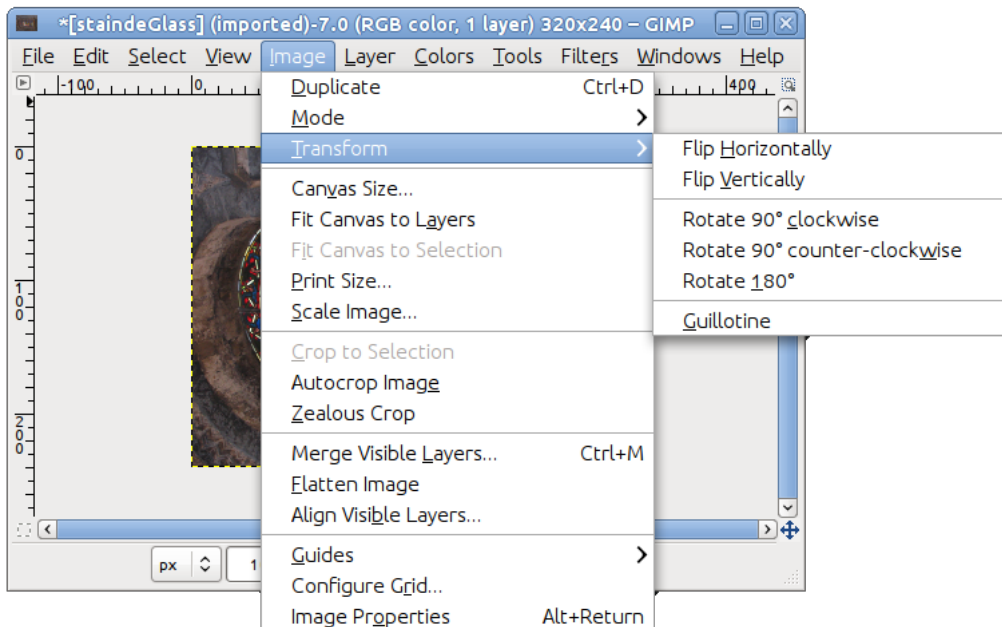
In the images below, all possible flips are demonstrated:

Figure 3.36 Example Image to Flip

*Source image**Horizontal flipped image**Vertical flipped image**Horizontal and vertical flipped image*

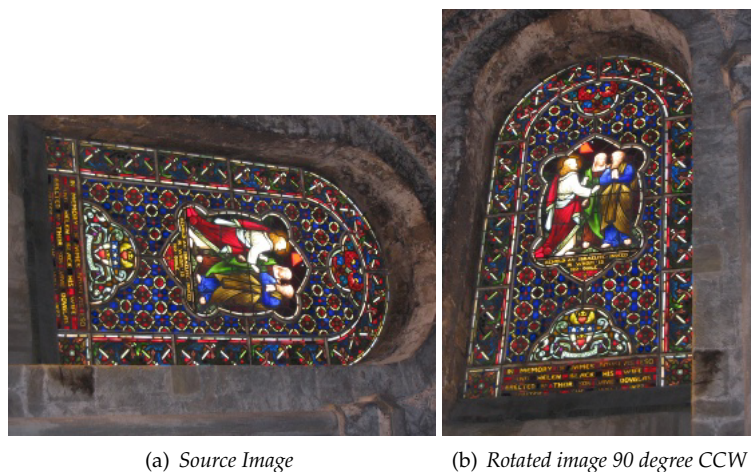
3.4.9 Rotate An Image

Figure 3.37 Menu for “Rotate An Image”



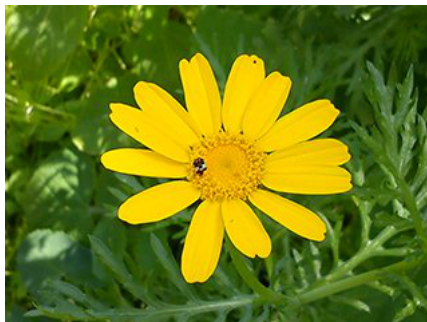
Images that are taken with digital cameras sometimes need to be rotated. To do this, use Image → Transform → Rotate 90° clockwise (or counter-clockwise). The images below demonstrate a 90 degrees CCW rotation.

Figure 3.38 Example for “Rotate An Image”



3.4.10 Separating an Object From Its Background

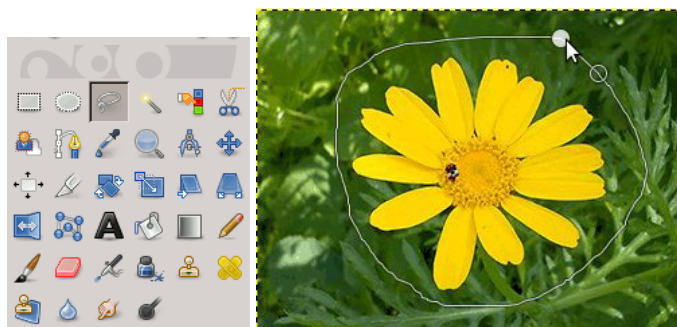
Figure 3.39 Object with Background



Sometimes you need to separate the subject of an image from its background. You may want to have the subject on a flat color, or keep the background transparent so you can use it on an existing background, or any other thing you have in mind. To do this, you must first use GIMP's selection tools to draw a selection around your subject. This is not an easy task, and selecting the correct tool is crucial. You have several tools to accomplish this:

- The **“Free Select Tool”** allows you to draw a border using either freehand or straight lines. Use this when the subject has a relatively simple shape. Read more about this tool here: [Section 14.2.4](#)

Figure 3.40 Free Select Tool

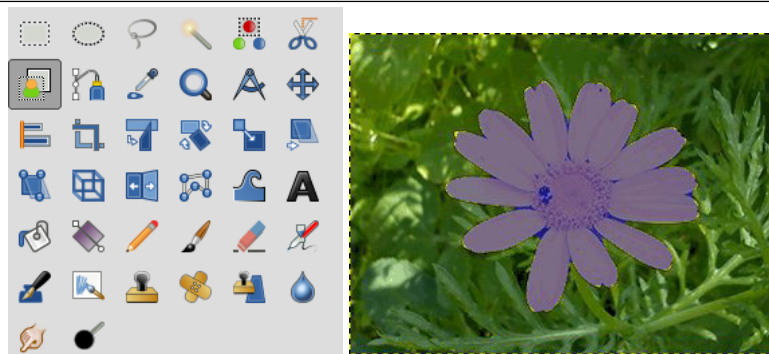


- The **“Intelligent Scissors Select tool”** lets you select a freehand border and uses edge-recognition algorithms to better fit the border around the object. Use this when the subject is complex but distinct enough against its current background. Read more about this tool here: [Section 14.2.7](#)

Figure 3.41 Intelligent Scissors Select Tool



- The **“Foreground Select Tool”** lets you mark areas as “Foreground” or “Background” and refines the selection automatically. Read more about this tool here: [Section 14.2.8](#)

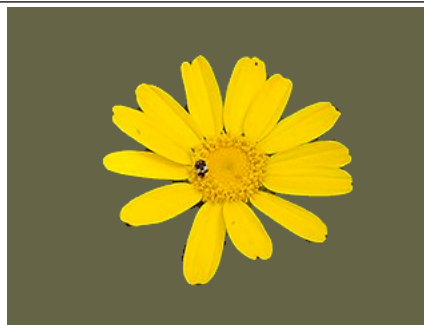
Figure 3.42 Foreground Select Tool

3.4.10.1 Once you have selected your subject

Once you have selected your subject successfully, use **Select → Invert**. Now, instead of the subject, the background is selected. What you do now depends on what you intended to do with the background:

- To fill the background with a single color:

Click the foreground color swatch (the top left of the two overlapping colored rectangles) in the toolbox and select the desired color. Next, use Section 14.3.4 to replace the background with your chosen color.

Figure 3.43 Result of Adding a Plain Color Background

- To make a black-and-white background while keeping the subject in color:

Use **Colors → Desaturate**. In the dialog that opens, cycle between the modes and select the best-looking one, then click OK.

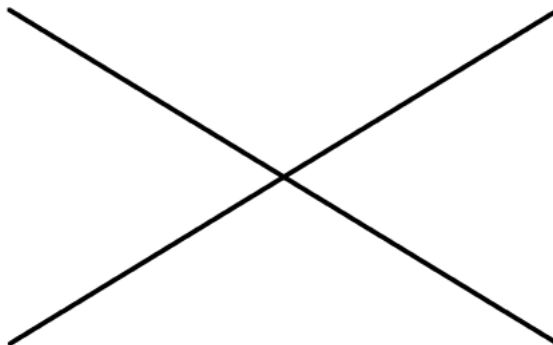
Figure 3.44 Result of Desaturating the Background

3.5 How to Draw Straight Lines

This tutorial is based on Text and images Copyright © 2002 Seth Burgess. The original tutorial can be found in the Internet [[TUT01](#)].

3.5.1 Intention

Figure 3.45 Example of straight lines



This tutorial shows you how to draw straight lines with GIMP. Forcing a line to be straight is a convenient way to deal with the imprecision of a mouse or tablet, and to take advantage of the power of a computer to make things look neat and orderly. This tutorial doesn't use Straight Lines for complex tasks; its intended to show how you can use it to create quick and easy straight lines.

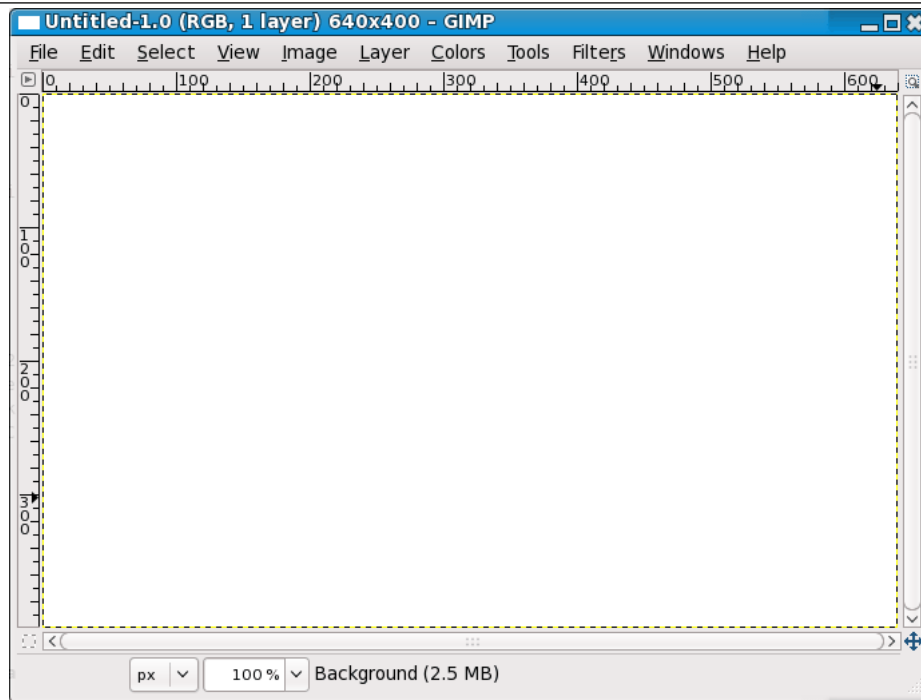
1. Preparations

Figure 3.46 Introducing the **Shift**-key



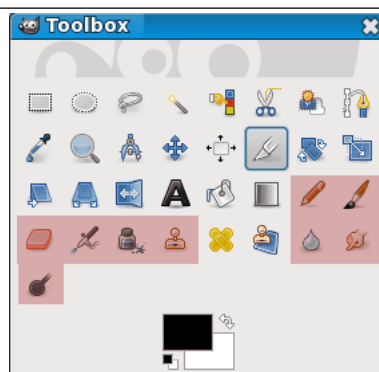
The invention called the typewriter introduced the **Shift** Key. You generally have 2 of them on your keyboard. They look something like the figure above. The keys are located on the left and right sides of your keyboard. The mouse was invented by Douglas C. Engelbart in 1970. These come in different varieties, but always have at least one button.

2. Creating a Blank Drawable

Figure 3.47 New image

First, create a new image. Any size will do. Use File → New to create a new image.

3. Choose a Tool

Figure 3.48 Paint tools in the toolbox

Any of the red-highlighted tools on the above toolbox can do lines.

4. Create a Starting Point

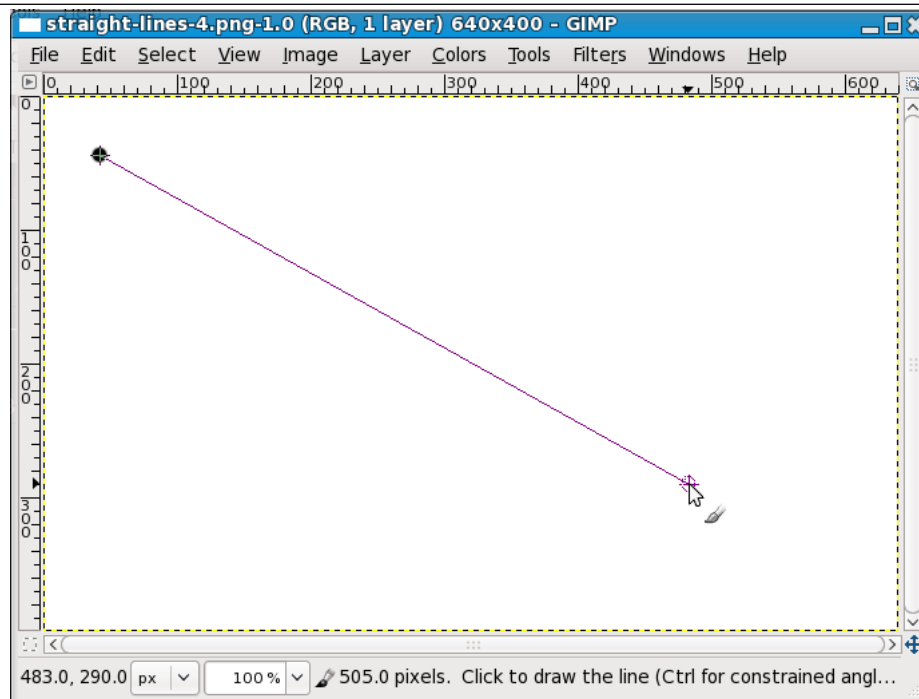
Figure 3.49 Starting point



Click on the paintbrush in the toolbox. Click in the image where you want a line to start or end. A single dot will appear on the screen. The size of this dot represents the current brush size, which you can change in the Brush Dialog (see Section 15.3.2). Now, let's start drawing a line. Hold down the **Shift** key, and keep it down.

5. Drawing the Line

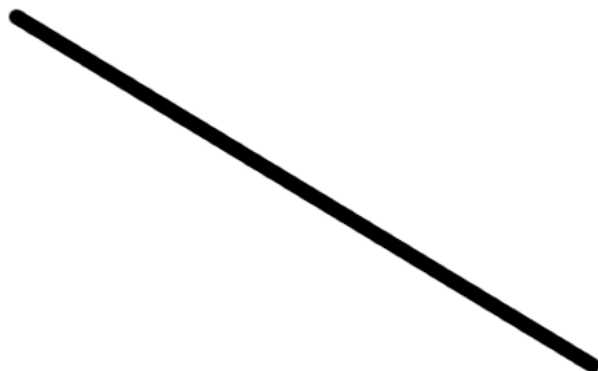
Figure 3.50 Drawing the line



After you have a starting point and while pressing the **Shift** key, you will see a straight line that follows the cursor. Press the first button on the mouse (the leftmost one usually) and let it go. During that whole “click” of the mouse button, you need to keep the **Shift** key held down.

6. Final

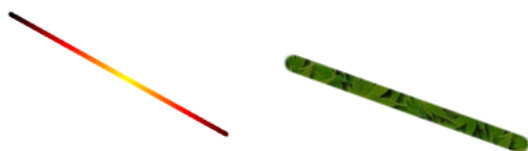
Figure 3.51 Final Image



This is a powerful feature. You can draw straight lines with any of the draw tools. You can even draw more lines at the end of this one. Our last step is to let go of the **Shift** key. And there you have it. Some more examples are shown below. Happy GIMPing!

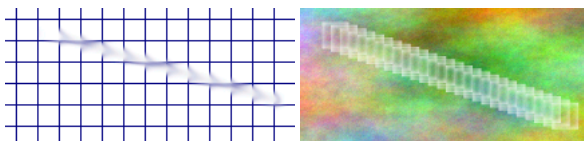
3.5.2 Examples

Figure 3.52 Examples I



(a) Check *Use color from gradient*.
 (b) Select the Clone tool and set the source to "Maple Leaves" pattern.

Figure 3.53 Examples II



(a) Use *Filters* → *Render* → *Pattern* → *Grid* to create a grid. Use the Smudge Tool to draw a cool plasma cloud. Use the Erase line with a slightly larger brush. Tool with a square brush to draw a line.
 (b) Use *Filters* → *Render* → *Clouds* → *Plasma* to create the

Figure 3.54 Example III



Use the rectangle select tool to select a rectangle, and then fill the selection with a light blue color. Select the dodge/burn tool. Set the type to Dodge and paint along the top and left side using an appropriately sized brush. Set the type to Burn and paint along the right and bottom.

Chapter 4

Getting Unstuck

4.1 Getting Unstuck

4.1.1 Stuck!

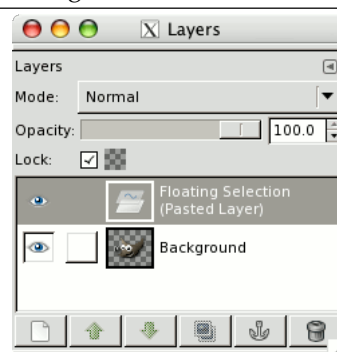
All right, okay: you're stuck. You're trying to use one of the tools on an image, and nothing is happening, and nothing you try makes any difference. Your fists are starting to clench, and your face is starting to feel warm. Are you going to have to kill the program, and lose all your work? This sucks!

Well, hold on a second. This happens pretty frequently, even to people who've used GIMP for a long time, but generally the cause is not so hard to figure out (and fix) if you know where to look. Lets be calm, and go through a checklist that will probably get you GIMPing happily again.

4.1.2 Common Causes of GIMP Non-Responsiveness

4.1.2.1 There is a floating selection

Figure 4.1 Layers dialog showing a floating selection.

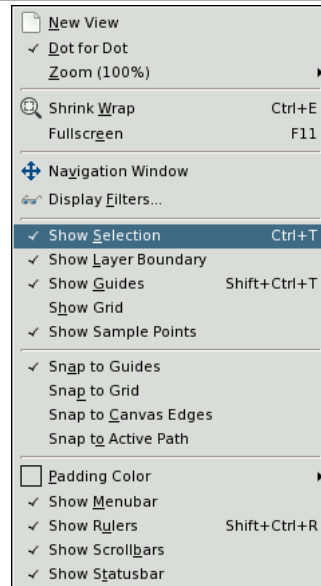


How to tell: If there is a floating selection, many actions are impossible until the floating section is anchored. To check, look at the Layers dialog (making sure it's set to the image you're working on) and see whether the top layer is called "Floating Selection".

How to solve: Either anchor the floating selection, or convert it into an ordinary (non-floating) layer. If you need help on how to do this, see [Floating Selections](#).

4.1.2.2 The selection is hidden

Figure 4.2 Unstuck show selection menu



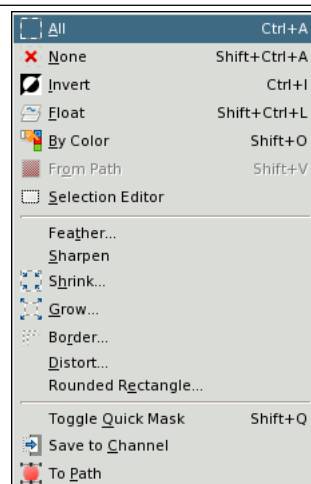
In the View menu, make sure that "Show Selection" is checked.

How to tell: If this is the problem, merely reading this will already have made you realize it, probably, but to explain in any case: sometimes the flickering line that outlines the selection is annoying because it makes it hard to see important details of the image, so GIMP gives you the option of hiding the selection, by unchecking Show Selection in the View menu. It is easy to forget that you have done this, though.

How to fix: If this hasn't rung any bells, it isn't the problem, and if it has, you probably know how to fix it, because it doesn't happen unless you explicitly tell it to; but anyway: just go to the View menu for the image and, if Show Selection is unchecked, click on it..

4.1.2.3 You are acting outside of the selection

Figure 4.3 Unstuck select all



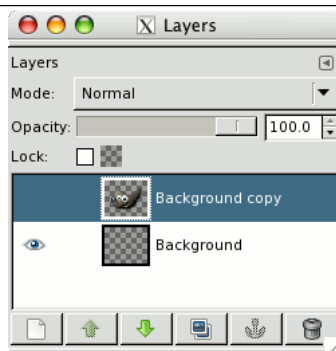
Click "All" in the Select menu to make sure that everything is selected.

How to fix: If doing this has destroyed a selection that you wanted to keep, hit Ctrl-Z (undo) a couple of times to restore it, and then we'll figure out what the problem is. There are a couple of possibilities. If you couldn't see any selection, there may have been a very tiny one, or even one that contained no pixels. If this was the case, it surely is not a selection that you wanted to keep, so why have you gotten this far in

the first place? If you can see a selection but thought you were inside it, it might be inverted from what you think. The easiest way to tell is to hit the Quick Mask button: the selected area will be clear and the unselected area will be masked. If this was the problem, then you can solve it by toggling Quick Mask off and choosing Invert in the Select menu.

4.1.2.4 The active drawable is not visible

Figure 4.4 Unstuck layer invisibility



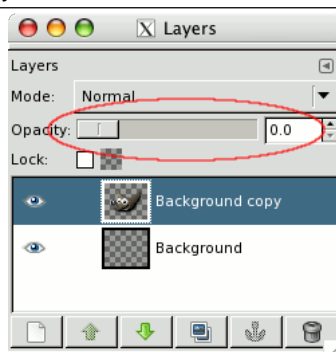
Layers dialog with visibility off for the active layer.

How to tell: The Layers dialog gives you ability to toggle the visibility of each layer on or off. Look at the Layers dialog, and see if the layer you are trying to act on is active (i.e., darkened) and has an eye symbol to the left of it. If not, this is your problem.

How to fix: If your intended target layer is not active, click on it in the Layers dialog to activate it. (If none of the layers are active, the active drawable might be a channel -- you can look at the Channels tab in the Layers dialog to see. This does not change the solution, though.) If the eye symbol does not appear, click in the Layers dialog at the left edge to toggle it: this should make the layer visible. See the Help section for the [Layers Dialog](#) if you need more help.

4.1.2.5 The active drawable is transparent

Figure 4.5 Unstuck layer transparency



Layers dialog with opacity set to zero for the active layer.

How to tell: When the opacity is set 0 on the layer, you cannot see anything which you draw on it. Look the Opacity slider, and see which side the slider placed at. If it is at the leftmost side, that is your problem.

How to fix: Move the slider.

4.1.2.6 You are trying to act outside the layer

How to tell: In GIMP, layers don't need to have the same dimensions as the image: they can be larger or smaller. If you try to paint outside the borders of a layer, nothing happens. To see if this is happening, look for a black-and-yellow dashed rectangle that does not enclose the area you're trying to draw at.

How to fix: You need to enlarge the layer. There are two commands at the bottom of the Layer menu that will let you do this: Layer to Image Size, which sets the layer bounds to match the image borders; and Layer Boundary Size, which brings up a dialog that allows you to set the layer dimensions to whatever you please.

4.1.2.7 The image is in indexed color mode.

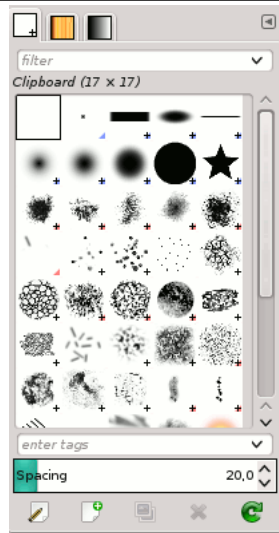
How to tell: GIMP can handle three different color modes: **RGB(A)**, **Indexed and Grayscale**. The indexed colormode uses a colormap, where all used colors on the image are indexed. The **color picker** in GIMP however, let you choose RGB colors. That means, if you try to paint with a different color than it is indexed in the colormap, you end up in very undetermined results (e.g. it paints with the wrong color or you can't paint).

How to fix: Always use the RGB Color mode to paint on images. You can verify and select another color mode from the **Mode** menuitem in the Image menu.

4.1.2.8 Eraser and brushes no longer work

You have selected the clipboard brush and the clipboard is empty.

Figure 4.6 Empty Clipboard Brush



Part II

How do I Become a GIMP Wizard?

Chapter 5

Getting Images into GIMP

This chapter is about getting images into GIMP. It explains how to create new images, how to load images from files, how to scan them and how to make screenshots.

But first we want to introduce you to the general structure of images in GIMP.

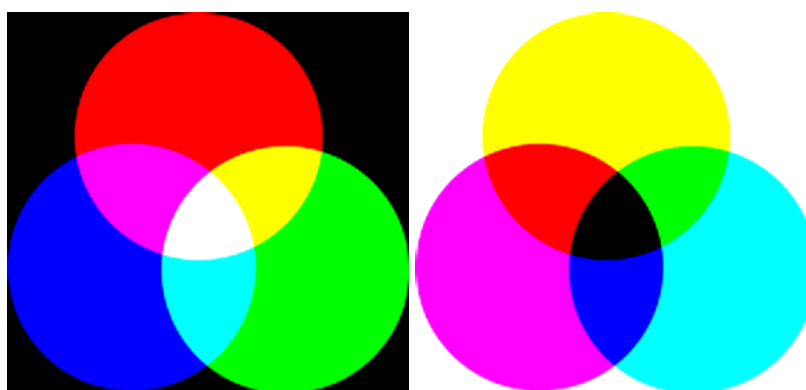
5.1 Image Types

It is tempting to think of an *image* as something that corresponds with a single display window, or to a single file such as a **JPEG** file. In reality, however, a GIMP image is a complicated structure, containing a stack of layers plus several other types of objects: a selection mask, a set of channels, a set of paths, an “undo” history, etc. In this section we take a detailed look at the components of a GIMP image, and the things that you can do with them.

The most basic property of an image is its *mode*. There are three possible modes: RGB, grayscale, and indexed. RGB stands for Red-Green-Blue, and indicates that each point in the image is represented by a “red” level, a “green” level, and a “blue” level; representing a full-color image. Each color channel has 256 possible intensity levels. More details in **Color Models**

In a grayscale image, each point is represented by a brightness value, ranging from 0 (black) to 255 (white), with intermediate values representing different levels of gray.

Figure 5.1 Components of the RGB and CMY Color Model



(a) In the RGB Color Model, mixing Red, Green and Blue gives White, which is what happens on your screen.

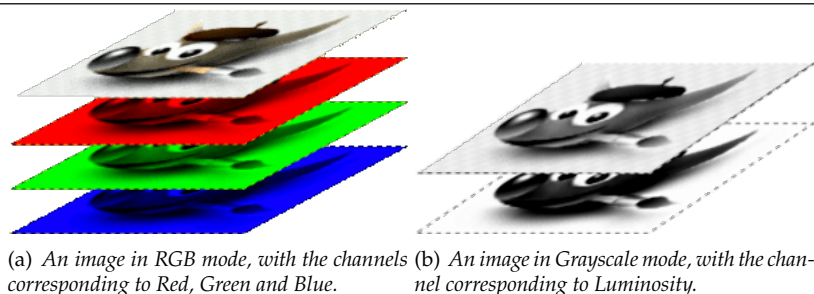
(b) In the CMY(K) color model, mixing Cyan, Magenta and Yellow gives Black, which is what happens when you print on a white paper. The printer will actually use the black cartridge for economical reasons and better color rendering.

Conceptually, the difference between a grayscale image and an RGB image is the number of “color channels”: a grayscale image has one; an RGB image has three. An RGB image can be thought of as three superimposed grayscale images, one colored red, one green, and one blue.

Actually, both RGB and grayscale images have one additional color channel called the *alpha* channel, which represents opacity. When the alpha value at a given location in a given layer is zero, the layer

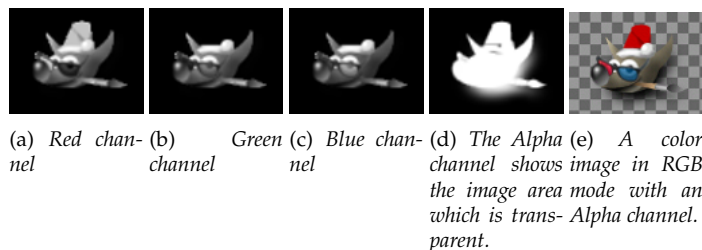
is completely transparent (you can see through it), and the color at that location is determined by what lies underneath. When alpha is maximal (255), the layer is opaque (you cannot see through it), and the color is determined by the color of the layer. Intermediate alpha values correspond to varying degrees of transparency / opacity: the color at the location is a proportional mixture of color from the layer and color from underneath.

Figure 5.2 Example of an image in RGB and Grayscale mode



In GIMP, in every color channel, including the alpha channel, possible values have a range depending on the image precision: 0 to 255 for a color depth of 8 bits. GIMP can now load 16 and 32 bits images, and this range can be much larger.

Figure 5.3 Example of an image with alpha channel



The third type, *indexed* images, is a bit more complicated to understand. In an indexed image, only a limited set of discrete colors are used, usually 256 or less (so, this indexed mode can be applied only to images with 8 bits precision). These colors form the “colormap” of the image, and each point in the image is assigned a color from the colormap. Indexed images have the advantage that they can be represented inside a computer in a way which consumes relatively little memory, and back in the dark ages (say, ten years ago), they were very commonly used. As time goes on, they are used less and less, but they are still important enough to be worth supporting in GIMP. (Also, there are a few important kinds of image manipulation that are easier to implement with indexed images than with continuous-color RGB images.)

Some very commonly used types of files (including **GIF** and **PNG**) produce indexed images when they are opened in GIMP. Many of GIMP’s tools don’t work very well on indexed images—and many filters don’t work at all—because of the limited number of colors available. Because of this, it is usually best to convert an image to RGB mode before working on it. If necessary, you can convert it back to indexed mode when you are ready to save it

GIMP makes it easy to convert from one image type to another, using the **Mode** command in the Image menu. Some types of conversions, of course (RGB to grayscale or indexed, for example) lose information that cannot be regained by converting back in the other direction.

Note



If you are trying to use a filter on an image, and it appears grayed out in the menu, usually the cause is that the image (or, more specifically, the layer) you are working on is the wrong type. Many filters can't be used on indexed images. Some can be used only on RGB images, or only on grayscale images. Some also require the presence or absence of an alpha channel. Usually the fix is to convert the image to a different type, most commonly RGB.

5.2 Creating new Files

Use File → New to open the Create a new image dialog. Modify the initial width and height of the file or use the standard values, then create a new image file. More information about the Create a new image dialog can be found in Section [16.2.2](#).

5.3 Opening Files

There are several ways of opening an existing image in GIMP:

5.3.1 Open File

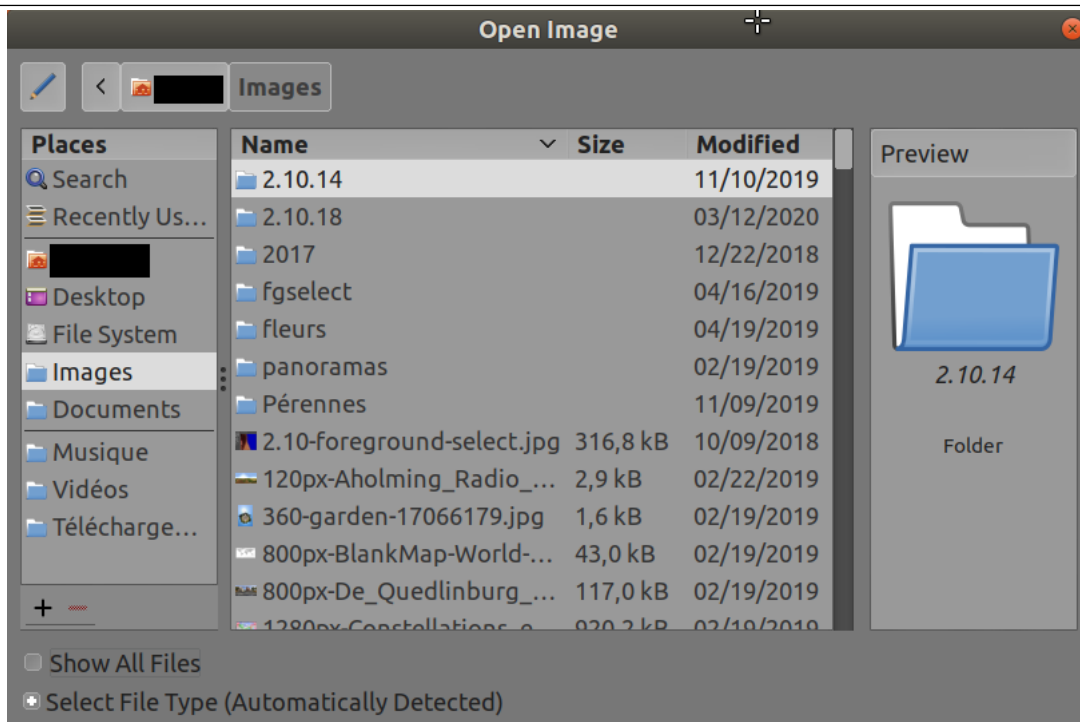
The most obvious way to open an existing image is the menu. Use File → Open to open the Open Image dialog, allowing you to navigate to the file and click on its name. This method works well if you know the name and location of the file you want to open. Although the Open Image dialog does have a preview pane, it is not convenient (easy) to find an image based on a thumbnail.

Note



While opening a file, GIMP must determine the file type. Unfortunately, the file extension, such as `.jpg`, is not reliable: file extensions vary from system to system; any file can be renamed to have any extension; and there are many reasons why a file name might lack an extension. GIMP first tries to recognize a file by examining its contents: most of the commonly used file formats have “magic headers” that permit them to be recognized. Only if the magic yields no result does GIMP resort to using the extension.

Figure 5.4 The “Open Image” dialog



GIMP 2.2 introduced a new Open Image dialog that provides several features to help you navigate quickly to a file. Perhaps the most important is the ability to create “bookmarks”, or Places, for folders that you use often. Your list of bookmarks appears on the left side of the dialog. The ones at the top, such as “Desktop”, are provided automatically. Use the the Add button to add the current directory to the list. Use the Remove button to remove the selected bookmark. Double-click on a bookmark to navigate directly to that directory.

The center of the dialog contains a listing of the contents of the selected directory. Subdirectories are shown at the top of the list, files below them. By default, all files in the directory are listed, but you can restrict the listing to image files of a specific type using the File Type selection menu that appears beneath the directory listing.

When you select an image file entry in the listing, a preview appears on the right side of the dialog, along with some basic information about the image. Note that previews are cached when they are generated, and there are some things you can do that may cause a preview to be incorrect. If you suspect that this may be happening, you can force a new preview to be generated by holding down the **Ctrl** key and clicking in the Preview area.

By default, a Location text box is present in the File Open dialog. It may be absent: the **Ctrl-L** key combination toggles this text box. Alternatively, you can click on the icon of the paper and pencil in the upper left corner to toggle the text box.

Note



If you select a file name from the list, and click the “Open” button in the lower right corner of the dialog, it is almost always true that GIMP will automatically determine the file type for you. On rare occasions, mainly if the file type is unusual and the name lacks a meaningful extension, GIMP may fail to correctly identify the file type. Use Select File Type at the bottom of the dialog to manually specify the file type if this is required. More commonly, though, if GIMP fails to open an image file, it is either corrupt or not a supported format.

5.3.1.1 Import from PDF

If you select a PDF file to open, GIMP will show an extra dialog with options specific to this file type.

Page selection You can select pages by typing one or more page numbers or ranges, separated by commas. For example, **4–7, 9** selects pages 4, 5, 6, 7, and 9 of the document. The default is to select all of the pages in the document.

Open pages as If this is set to Images, then GIMP will open each of the selected pages as a separate image. If it is set to Layers, then GIMP will create one image with each of the selected pages in its own layer.

Image size The size of the image created is controlled by the Width, Height, and Resolution settings. A PDF document contains information about its width and height in units of physical length so it is meaningful to set the width or height of the image in pixels or its resolution in pixels per physical unit of length: as you set any of these three parameters, the other two will automatically adjust to match.

Use Anti-Aliasing Check this box to apply **antialiasing** to text in the image.

5.3.1.2 Import from PostScript

If you select a PostScript file to open, GIMP will show an extra dialog with options specific to this file type.

Page selection You can select pages by typing one or more page numbers or ranges, separated by commas. For example, **4–7, 9** selects pages 4, 5, 6, 7, and 9 of the document. The default is to select all of the pages in the document.

Open pages as If this is set to Images, then GIMP will open each of the selected pages as a separate image. If it is set to Layers, then GIMP will create one image with each of the selected pages in its own layer.

Rendering The size of the image created is controlled by the Width, Height, and Resolution settings. A PostScript document contains information about its width and height in units of physical length so it is meaningful to set the width or height of the image in pixels or its resolution in pixels per physical unit of length: as you set any of these three parameters, the other two will automatically adjust to match.

Colouring Select B/W to have GIMP create the image as a 2-color indexed image, Gray for a grayscale image, or Color for an RGB image (see Section 5.1 for a full explanation of these different image modes). If you select Automatic then GIMP will try to determine the most suitable mode from the contents of the file.

Try Bounding Box If this is checked, GIMP will use the bounding box information in the PostScript file to determine how much of the page to use: effectively, this is equivalent to cropping whitespace from the edges of the image. It is possible for a PostScript file to contain no bounding box information, in which case this option will be ignored.

Antialiasing You can choose to have GIMP apply **antialiasing** separately for text and for graphics in the imported image. Either Weak or Strong antialiasing may be applied: usually you should select Strong.

5.3.2 Open Location

If instead of a file name, you have a URI (i.e., a web address) for the image, you can open it using the menu, by choosing File → Open Location... from an image menu. This brings up a small dialog that allows you to enter (or paste) the URI.

Figure 5.5 The “Open Location” dialog*The “Open Location” dialog.*

5.3.3 Open Recent

The easiest way to open an image that was recently open in GIMP, may be using File → Open Recent. This displays a scrollable list of the mostly recently opened images with icons beside them. Select and open the desired image.

5.3.4 Using External Programs

GIMP uses plugins for reading and writing all file formats except XCF. These plugins may use external libraries or programs. For example, GIMP does not directly support **PDF** and **PostScript**. Instead, for reading (or writing) PDF (file extension `.pdf`) and PostScript files (file extension `.ps` or `.eps`), GIMP requires a powerful free software program called Ghostscript.

Linux distributions almost always come with Ghostscript already installed (not necessarily the most recent version). On Windows Ghostscript[[GHOSTSCRIPT](#)] is included in the installer so you don't need to install it separately.

5.3.5 File Manager

If you have associated an image file type with GIMP, either when you installed GIMP or later, then you can navigate to the file using a file manager (such as Nautilus or Konqueror in Linux, or Windows Explorer in Windows), and once you have found it, double-click on the file. If properly configured, the image will open in GIMP.

5.3.6 Drag and Drop

Drag and drop a file onto the GIMP Toolbox to open the file. Drag an image into an open GIMP image to add dropped file as a new layer, or set of layers, to the already open image.

Many applications support dragging and dropping an image into GIMP; for example, drag an image from Firefox and drop it onto GIMP's toolbox.

5.3.7 Copy and Paste

Use File → Create → From Clipboard to create a new image from the clipboard; alternatively, you can use Edit → Paste as → New Image. Many applications support copying an image to the clipboard that can then be pasted into GIMP. Many operating systems support copying screens to the clipboard. **Print Screen** typically copies the screen to the clipboard, and **Alt-Print Screen** copies only the active window. Print screen is not universally supported, and just because your operating system can copy an image to the clipboard, does not mean that GIMP can use the image from the clipboard. Your best bet is to try it and see if it works.

5.3.8 Image Browser

Linux supports an image-management application named gThumb. Besides being an excellent image browser, you can right click an image, choose Open with, then select GIMP from the list of options. You can also drag an image from gThumb onto the GIMP toolbox. See the gThumb home page [[GTHUMB](#)] for more information. Other similar application is Geeqie [[GEEQIE](#)].

Chapter 6

Getting Images out of GIMP

6.1 Files

GIMP is capable of reading and writing a large variety of graphics file formats. With the exception of GIMP's native XCF file type, file handling is done by Plugins. Thus, it is relatively easy to extend GIMP to support new file types when the need arises.

6.1.1 Save / Export Images

Note



In former GIMP releases, when you loaded an image in some format, let us say JPG or PNG, the image kept its format and was saved in the same format by **Save**. With GIMP-2.8, images are loaded, imported, in the XCF format as a new project. For example, a “sunflower.png” image will be loaded as “[sunflower] (imported)-1.0 (indexed color, 1 layer)”. The leading asterisk indicates that this file has been changed. This image will be saved as “sunflower.xcf” by **Save**. To save this image in a format other than XCF, you must use **Export**.

When you are finished working with an image, you will want to save the results. (In fact, it is often a good idea to save at intermediate stages too: GIMP is a pretty robust program, but we have heard rumors, possibly apocryphal, that it may have been known on rare and mysterious occasions to crash.) Most of the file formats that GIMP can open, can also be used for saving. There is one file format that is special, though: XCF is GIMP's native format, and is useful because it stores *everything* about an image (well, almost everything; it does not store “undo” information). Thus, the XCF format is especially suitable for saving intermediate results, and for saving images to be re-opened later in GIMP. XCF files are not readable by most other programs that display images, so once you have finished, you will probably also want to export the image in a more widely used format, such as JPEG, PNG, TIFF, etc.

6.1.2 File Formats

There are several commands for *saving* images. A list, and information on how to use them, can be found in the section covering the **File Menu**.

GIMP allows you to *export* the images you create in a wide variety of formats. It is important to realize that the only format capable of saving *all* of the information in an image, including layers, transparency, etc., is GIMP's native XCF format. Every other format preserves some image properties and loses others. It is up to you to understand the capabilities of the format you choose.

Exporting an image does not modify the image itself, so you do not lose anything by exporting. See **Export file**.

Note

When you close an image (possibly by quitting GIMP), you are warned if the image is "dirty"; that is, if it has been changed without subsequently being saved (an asterisk is in front of the image name).

Figure 6.1 Closing warning



Saving an image in any file format will cause the image to be considered "not dirty", even if the file format does not represent all of the information from the image.

6.1.2.1 Export Image as GIF

Figure 6.2 The GIF Export dialog



Warning



The GIF file format does not support some basic image properties such as *print resolution*. If you care for these properties, use a different file format like PNG.

GIF Options

Interlace Checking interlace allows an image on a web page to be progressively displayed as it is downloaded. Progressive image display is useful with slow connection speeds, because you can stop an image that is of no interest; interlace is of less use today with our faster connection speeds.

GIF comment GIF comments support only 7-bit ASCII characters. If you use a character outside the 7-bit ASCII set, GIMP will export the image without a comment, and then inform you that the comment was not saved.

Animated GIF Options

Loop forever When this option is checked, the animation will play repeatedly until you stop it.

Delay between frames where unspecified You can set the delay, in milliseconds, between frames if it has not been set before. In this case, you can modify every delay in the Layer Dialog.

Frame disposal where unspecified If this has not been set before, you can set how frames will be superimposed. You can select among three options :

- I don't care: you can use this option if all your layers are opaque. Layers will overwrite what is beneath.
- Cumulative Layers (combine): previous frames will not be deleted when a new one is displayed.
- One frame per layer (replace): previous frames will be deleted before displaying a new frame.

Use delay entered above for all frames Self-explanatory.

Use disposal entered above for all frames Self-explanatory.

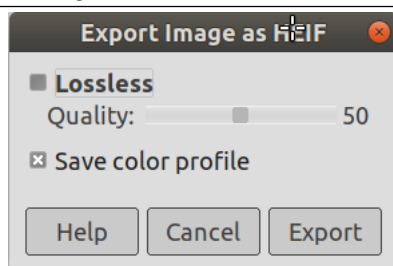
6.1.2.2 Export Image as HEIF/HEIC

HEIF stands for High Efficiency Image File Format. Also known as HEIC High Efficiency Image Coding.

Twice as much information can be stored in a HEIF image as in a JPEG image of the same size, resulting in a better quality. As of October 2019, no browser supports HEIF natively.

More information in [Wikipedia](#).

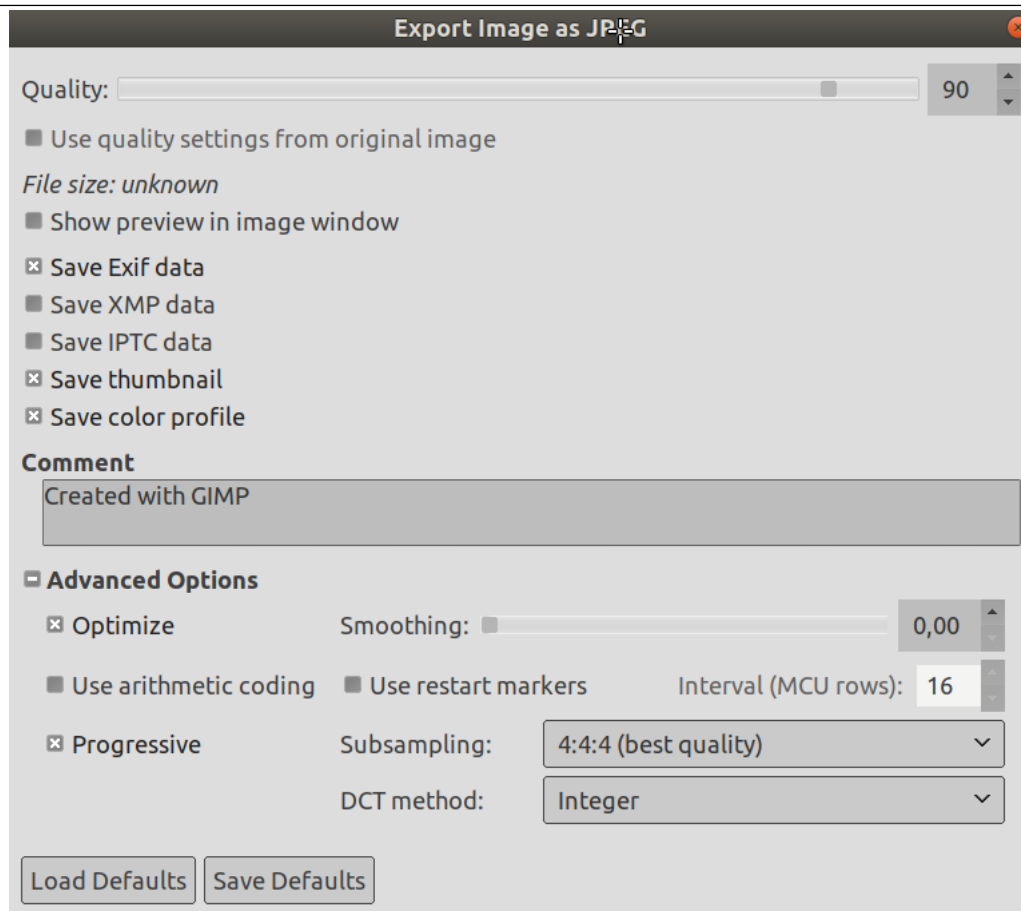
Figure 6.3 The HEIF/HEIC Export dialog



These options are self-explanatory.

6.1.2.3 Export Image as JPEG

JPEG files usually have an extension .jpg, .JPG, or .jpeg. It is a very widely used format, because it compresses images very efficiently, while minimizing the loss of image quality. No other format comes close to achieving the same level of compression. It does not, however, support transparency or multiple layers.

Figure 6.4 The JPEG Export dialog

The JPEG algorithm is quite complex, and involves a bewildering number of options, whose meaning is beyond the scope of this documentation. Unless you are a JPEG expert, the Quality parameter is probably the only one you will need to adjust.

Quality When you save a file in JPEG format, a dialog is displayed that allows you to set the Quality level, which ranges from 0 to 100. Values above 95 are generally not useful, though. The default quality of 85 usually produces excellent results, but in many cases it is possible to set the quality substantially lower without noticeably degrading the image. You can test the effect of different quality settings by checking Show Preview in image window in the JPEG dialog.

Note



Please note, that the numbers for the JPEG quality level have a different meaning in different applications. Saving with a quality level of 80 in GIMP is not necessarily comparable with saving with a quality level of 80 in a different application.

Use quality settings from original image If a particular quality setting (or “quantization table”) was attached to the image when it was loaded, then this option allows you to use them instead of the standard ones.

If you have only made a few changes to the image, then re-using the same quality setting will give you almost the same quality and file size as the original image. This will minimize the losses caused by the quantization step, compared to what would happen if you used different quality setting.

If the quality setting found in the original file are not better than your default quality settings, then the option “Use quality settings from original image” will be available but not enabled. This

ensures that you always get at least the minimum quality specified in your defaults. If you did not make major changes to the image and you want to save it using the same quality as the original, then you can do it by enabling this option.

Show preview in image window Checking this option causes each change in quality (or any other JPEG parameter) to be shown in the image display. (This does not alter the image: the image reverts back to its original state when the JPEG dialog is closed.)

Keep metadata If the image you loaded has Exif, XMP, IPTC metadata, they are preserved, and you can keep them or not when exporting to JPEG.

Save thumbnail, Save color profile Many applications use the small thumbnail image as a quickly available small preview image.

Comment You can edit the comment attached to the image you loaded or write a new one.

Advanced Options Some information about the advanced settings:

Optimize If you enable this option, the optimization of entropy encoding parameters will be used. The result is typically a smaller file, but it takes more time to generate.

Smoothing JPG compression creates artifacts. By using this option, you can smooth the image when saving, reducing them. But your image becomes somewhat blurred.

Use arithmetic coding *Arithmetic encoding* is a form of entropy encoding (a lossless data compression scheme) that, since GIMP-2.10 can be used in exporting as JPEG. Images using arithmetic encoding can be 5 - 10 % smaller. But older softwares may have trouble opening these images.

Use restart markers The image file can include markers which allow the image to be loaded as segments. If a connection is broken while loading the image in a web page, loading can resume from the next marker.

Interval (MCU rows) JPEG images are stored as a series of compressed square tiles named MCU (Minimum Coding Unit). You can set the size of these tiles (in pixels).

Progressive With this option enabled, the image chunks are stored in the file in an order that allows progressive image refinement during a slow connection web download. The progressive option for JPG has the same purpose as the interlace option for GIF. Unfortunately, the progressive option produces slightly larger JPG files (than without the progressive option).

Subsampling The human eye is not sensitive in the same way over the entire color spectrum. The compression can use this to treat slightly different colors that the eye perceives as very close, as identical colors. Three methods are available :

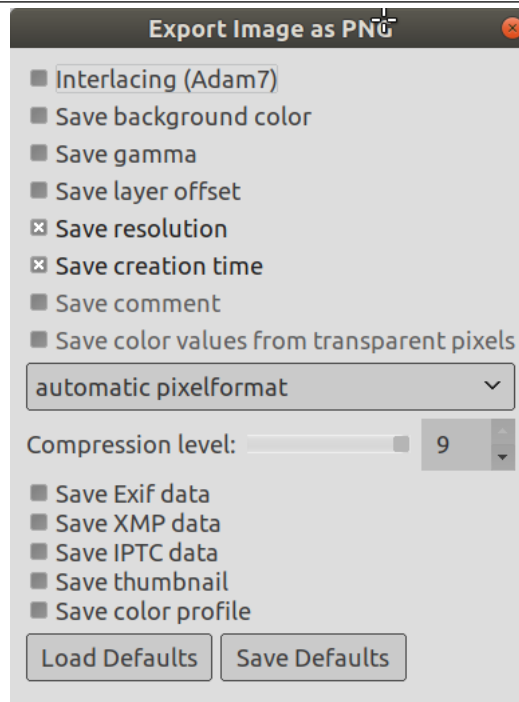
- 1x1,1x1,1x1 (best quality): Commonly referred to as (4:4:4), this produces the best quality, preserving borders and contrasting colors, but compression is less.
- 2x1,1x1,1x1 (4:2:2): This is the standard subsampling, which usually provides a good ratio between image quality and file size. There are situations, however, in which using no subsampling (4:4:4) provides a noticeable increase in the image quality; for example, when the image contains fine details such as text over a uniform background, or images with almost-flat colors.
- 1x2,1x1,1x1 This is similar to (2x1,1x1,1x1), but the chroma sampling is in the horizontal direction rather than the vertical direction; as if someone rotated an image.
- 2x2,1x1,1x1 (smallest file): Commonly referred to as (4:1:1), this produces the smallest files. This suits images with weak borders but tends to denature colors.

DCT Method DCT is “discrete cosine transform”, and it is the first step in the JPEG algorithm going from the spatial to the frequency domain. The choices are “float”, “integer” (the default), and “fast integer”.

- float: The float method is very slightly more accurate than the integer method, but is much slower unless your machine has very fast floating-point hardware. Also note that the results of the floating-point method may vary slightly across machines, while the integer methods should give the same results everywhere.
- integer (the default): This method is faster than “float”, but not as accurate.
- fast integer: The fast integer method is much less accurate than the other two.

6.1.2.4 Export Image as PNG

Figure 6.5 The “Export Image as PNG” dialog



Interlacing Checking interlace allows an image on a web page to be progressively displayed as it is downloaded. Progressive image display is useful with slow connection speeds, because you can stop an image that is of no interest; interlace is of less use today with our faster connection speeds.

Save background color If your image has many transparency levels, the Internet browsers that recognize only two levels, will use the background color of your Toolbox instead.

Save gamma Gamma correction is the ability to correct for differences in how computers interpret color values. This saves gamma information in the PNG that reflects the current Gamma factor for your display. Viewers on other computers can then compensate to ensure that the image is not too dark or too bright.

Save layer offset PNG supports an offset value called the “oFFs chunk”, which provides position data. Unfortunately, PNG offset support in GIMP is broken, or at least is not compatible with other applications, and has been for a long time. Do not enable offsets, let GIMP flatten the layers before saving, and you will have no problems.

Save Resolution Save the image resolution, in ppi (pixels per inch).

Save creation time Date the file was saved.

Save comment You can read this comment in the [Image Properties](#).

Save color values from transparent pixels When this option is checked, the color values are saved even if the pixels are completely transparent. But this is possible only with a single layer, not with a merged composition. When a multi-layer image gets exported to a single-layer file format, there is no way GIMP could preserve the color values in the transparent pixels.

Pixelformat TODO

Compression level Since compression is not lossy, the only reason to use a compression level less than 9, is if it takes too long to compress a file on a slow computer. Nothing to fear from decompression: it is as quick whatever the compression level.

Keep metadata If the image you loaded has Exif, XMP, IPTC metadata, they are preserved, and you can keep them or not when exporting to PNG.

Save Defaults Click to save the current settings. Latter, you can use Load Defaults to load the saved settings.

Note

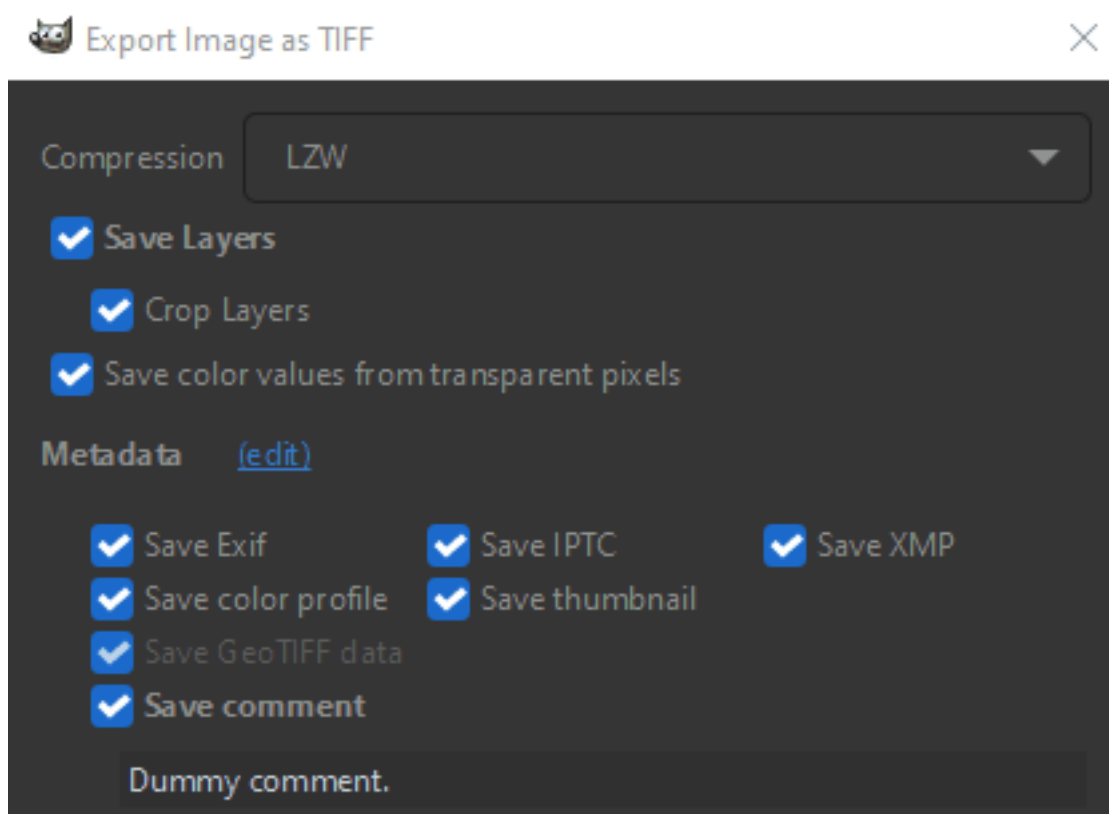


The PNG format supports indexed images. Using fewer colors, therefore, results in a smaller file; this is especially useful for creating web images; see Section 16.6.6.

Computers work on 8 bits blocks named “Byte”. A byte allows 256 colors. Reducing the number of colors below 256 is not useful: a byte will be used anyway and the file size will not be less. More, this “PNG8” format, like GIF, uses only one bit for transparency; only two transparency levels are possible, transparent or opaque.

6.1.2.5 Export Image as TIFF

Figure 6.6 The TIFF Export dialog



Compression This option allows you to specify the algorithm used to compress the image.

- None: is fast, and lossless, but the resulting file can be very large.
- LZW: The image is compressed using the “Lempel-Ziv-Welch” algorithm, a lossless compression technique. This is efficient and fast. More information at [WKPD-LZW].
- Pack Bits: is a fast, simple compression scheme for run-length encoding of data. Apple introduced the PackBits format with the release of MacPaint on the Macintosh computer. A

PackBits data stream consists of packets of one byte of header followed by data. (Source: [WKP-D-PACKBITS])

- Deflate: is a lossless data compression algorithm that uses a combination of the LZ77 algorithm and Huffman coding. It is also used in Zip and Gzip files and PNG images. Source: [WKP-D-DEFLATE].
- JPEG: is a very good compression algorithm but lossy. This is the same compression as used in JPEG images. Since it is lossy, you should not use this when image quality is important. This compression can not be used when your image is in indexed mode.
- CCITT Group 3 fax and CCITT Group 4 fax are black and white formats developed to transfer images by FAX.

Note



These two compression modes can only be selected, if the image is in indexed mode and reduced to two colors. Use Image → Mode → Indexed to convert the image to indexed mode. Make sure that “Use black and white (1-bit) palette” is checked.

Save layers Since GIMP-2.10.12, you can save layers when exporting to TIFF. Each layer will be a separate page in the TIFF image.

Crop layers When Save layers is checked, this option, which is enabled by default, will resize all layers to the size of the image. TIFF images can not have negative offsets. This option enables you to import the TIFF again without having to change the position of layers that had a different size as the image in the original.

Save color values from transparent pixels When this is enabled the color values are saved even if the pixels are completely transparent.

Metadata (edit) You can click the “(edit)” link to open the metadata editor to change or add any metadata that you want to be included in the image. Note: you will also still need to enable the relevant metadata saving options listed below.

Save Exif data When this option is enabled existing EXIF metadata will be saved in the exported TIFF image.

Save IPTC data When this option is enabled existing IPTC metadata will be saved in the exported TIFF image.

Save XMP data When this option is enabled existing XMP metadata will be saved in the exported TIFF image.

Save color profile When this option is enabled the color profile will be saved in the exported TIFF image.

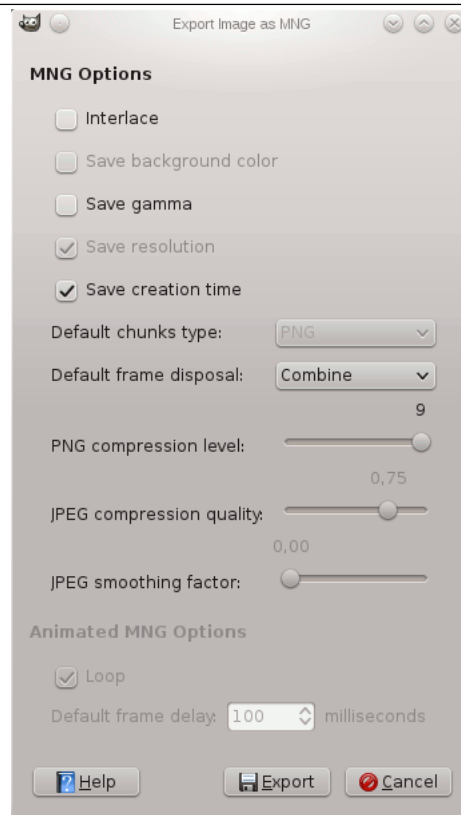
Save thumbnail When this option is enabled a thumbnail will be saved as the second page in the exported TIFF image. This will also cause certain EXIF tags to be saved even if you have disabled saving EXIF metadata.

Save GeoTIFF data When this option is enabled GeoTIFF metadata that was present in the original image will be saved in the exported TIFF image.

Save comment Here you can enable saving a comment that is associated with the image. The comment can be entered in the text box below this option.

6.1.2.6 Export Image as MNG

Figure 6.7 Export MNG File Dialog



MNG is acronym for “Multiple-Image Network Graphics”.

The main problem is that Konqueror is the only Web navigator that recognizes the MNG animation format. Please see http://en.wikipedia.org/wiki/Multiple-image_Network_Graphics.

6.2 Preparing your Images for the Web

One of the most common uses for GIMP, is to prepare images for web sites. This means that images should look as nice as possible while keeping the file size as small as possible. This step-by-step guide demonstrates how to create small files with minimal loss of image quality.

6.2.1 Images with an Optimal Size/Quality Ratio

An optimal image for the web depends upon the image type and the file format. Use **JPEG** for Photographs because they usually have many colors and great detail. An image with fewer colors, such as a button, icon, or screenshot, is better suited to the **PNG** format.

1. First, open the image as usual. I have opened our Wilber as an example image.

Figure 6.8 The Wilber image opened in RGBA mode



2. The image is now in RGB mode, with an additional **Alpha channel** (RGBA). There is usually no need to have an alpha channel for your web image. You can remove the alpha channel by **flattening the image**.

A photograph rarely has an alpha channel, so the image will open in RGB mode rather than RGBA mode; and you won't have to remove the alpha channel.

Note



If the image has a soft transition into the transparent areas, you should not remove the alpha channel, since the information used for the transition is not be saved in the file. To export an image with transparent areas that do not have a soft transition, (similar to **GIF**), remove the alpha channel.

3. After you have flattened the image, **export the image** in the **PNG format** for your web site.

Note

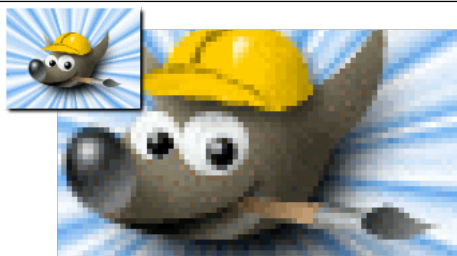


You can export your image in the PNG format with the default settings. Always using maximum compression when creating the image. Maximum compression has no effect on image quality or the time required to display the image, but it does take longer to export. A **JPEG** image, however, loses quality as the compression is increased. If your image is a photograph with lots of colors, you should use jpeg. The main thing is to find the best tradeoff between quality and compression. You can find more information about this topic in Section **6.1.2.3**.

6.2.2 Reducing the File Size Even More

If you want to reduce the size of your image a bit more, you could convert your image to Indexed mode. That means that all of the colors will be reduced to only 256 values. Do not convert images with smooth color transitions or gradients to indexed mode, because the original smooth gradients are typically converted into a series of bands. Indexed mode is not recommended for photographs because after the conversion, they typically look coarse and grainy.

Figure 6.9 The indexed image



An indexed image can look a bit grainy. The left image is Wilber in its original size, the right image is zoomed in by 300 percent.

1. Use the command described in Section 16.6.3 to convert an RGB image to indexed mode.
2. After you convert an image to indexed mode, you are once again able to **export** the image in **PNG format**.

6.2.3 Saving Images with Transparency

There are two different approaches used by graphic file formats for supporting transparent image areas: simple binary transparency and alpha transparency. Simple binary transparency is supported in the **GIF** format; one color from the indexed color palette is marked as the transparent color. Alpha transparency is supported in the **PNG** format; the transparency information is stored in a separate channel, the **Alpha channel**.

Note



The GIF format is rarely used because PNG supports all the features of GIF with additional features (e.g., alpha transparency). Nevertheless, GIF is still used for animations.

Creating an Image with Transparent Areas (Alpha Transparency)

1. First of all, we will use the same image as in the previous tutorials, Wilber the GIMP mascot.

Figure 6.10 The Wilber image opened in RGBA mode



2. To export an image with alpha transparency, you must have an alpha channel. To check if the image has an alpha channel, go to the **channel dialog** and verify that an entry for “Alpha” exists, besides Red, Green and Blue. If this is not the case, **add a new alpha channel** from the layers menu; Layer+Transparency → Add Alpha Channel.
 3. The original XCF file contains background layers that you can remove. GIMP comes with standard filters that supports creating gradients; look under Filters+Light and Shadow. You are only limited by your imagination. To demonstrate the capabilities of alpha transparency, a soft glow in the background around Wilber is shown.
-

4. After you're done with your image, you can **export** it in **PNG format**.

Figure 6.11 The Wilber image with transparency



Mid-Tone Checks in the background layer represent the transparent region of the exported image while you are working on it in GIMP.

Chapter 7

Painting with GIMP

7.1 The Selection

Often when you operate on an image, you only want part of it to be affected. In GIMP, you make this happen by *selecting* that part. Each image has a *selection* associated with it. Most, but not all, GIMP operations act only on the selected portions of the image.

Figure 7.1 How would you isolate the tree?



There are many, many situations where creating just the right selection is the key to getting the result you want, and often it is not easy to do. For example, in the above image, suppose I want to cut the tree out from its background, and paste it into a different image. To do this, I need to create a selection that contains the tree and nothing but the tree. It is difficult because the tree has a complex shape, and in several spots is hard to distinguish from the objects behind it.

Figure 7.2 Selection shown as usual with dashed line.



Now here is a very important point, and it is crucial to understand this. Ordinarily when you create a selection, you see it as a dashed line enclosing a portion of the image. The common, not entirely accurate, idea you could get from this, is that the selection is a sort of container, with the selected parts of the image inside, and the unselected parts outside. Although this concept of selection is okay for many purposes, it is not entirely correct.

Actually the selection is implemented as a *channel*. In terms of its internal structure, it is identical to the red, green, blue, and alpha channels of an image. Thus, the selection has a value defined at each pixel of the image, ranging between 0 (unselected) and 255 (fully selected). The advantage of this approach is that it allows some pixels to be *partially selected*, by giving them intermediate values between 0 and 255. As you will see, there are many situations where it is desirable to have smooth transitions between selected and unselected regions.

What, then, is the dashed line that appears when you create a selection?

The dashed line is a *contour line*, dividing areas that are more than half selected from areas that are less than half selected.

Figure 7.3 Same selection in QuickMask mode.



While looking at the dashed line that represents the selection, always remember that the line tells only part of the story. If you want to see the selection in complete detail, the easiest way is to click the QuickMask button in the lower left corner of the image window. This causes the selection to be shown as a translucent overlay atop the image. Selected areas are unaffected; unselected areas are reddened. The more completely selected an area is, the less red it appears.

Many operations work differently in QuickMask mode, as mentioned in the [QuickMask overview](#). Use the QuickMask button in the lower left corner of the image window to toggle QuickMask mode on and off.

Figure 7.4 Same selection in QuickMask mode after feathering.



7.1.1 Feathering

With the default settings, the basic selection tools, such as the Rectangle Select tool, create sharp selections. Pixels inside the dashed line are fully selected, and pixels outside completely unselected. You can verify this by toggling QuickMask: you see a clear rectangle with sharp edges, surrounded by uniform red. Use the “Feather edges” checkbox in the Tool Options to toggle between graduated selections and sharp selections. The feather radius, which you can adjust, determines the distance over which the transition occurs.

If you are following along, try this with the Rectangle Select tool, and then toggle QuickMask. You will see that the clear rectangle has a fuzzy edge.

Feathering is particularly useful when you are cutting and pasting, so that the pasted object blends smoothly and unobtrusively with its surroundings.

It is possible to feather a selection at any time, even if it was originally created as a sharp selection. Use Select → Feather from the image menu to open the Feather Selection dialog. Set the feather radius and

click OK. Use Select → Sharpen to do the opposite—sharpen a graduated selection into an all-or-nothing selection.

Note



For technically oriented readers: feathering works by applying a Gaussian blur to the selection channel, with the specified blurring radius.

7.1.2 Making a Selection Partially Transparent

You can set layer opacity, but you cannot do that directly for a selection. It is quite useful to make the image of a glass transparent. Use the following methods to set the layer opacity:

- For simple selections, use the Eraser tool with the desired opacity.
- For complex selections: use Select → Float to create a floating selection. This creates a new layer with the selection called “Floating Selection” (Section 16.4.5). Set the opacity slider in the Layer Dialog to the desired opacity. Then anchor the selection: outside the selection, the mouse pointer includes an anchor. When you click while the mouse pointer includes the anchor, the floating selection disappears from the Layer Dialog and the selection is at the right place and partially transparent (anchoring works this way only if a selection tool is activated : you can also use the Anchor Layer command in the context menu by right clicking on the selected layer in the layer dialog).

And, if you use this function frequently: Ctrl-C to copy the selection, Ctrl-V to paste the clipboard as a floating selection, and Layer → New Layer to turn the selection into a new layer. You can adjust the opacity before, or after creating the new layer.

- Another way: use Layer → Mask → Add Layer Mask to add a layer mask to the layer with the selection, initializing it with the selection. Then use a brush with the desired opacity to paint the selection with black, i.e. paint it with transparency. Then Layer/Mask/Apply Layer Mask. See Section 15.2.1.3.
- To make the solid background of an image transparent, add an Alpha channel, and use the Magic Wand to select the background. Then, use the Color Picker tool to select the background color, which becomes the foreground color in Toolbox. Use the Bucket Fill tool with the selected color. Set the Bucket Fill mode to “Color Erase”, which erases pixels with the selected color; other pixels are partially erased and their color is changed.

The simplest method is to use Edit → Clear, which gives complete transparency to a selection.

7.2 Creating and Using Selections

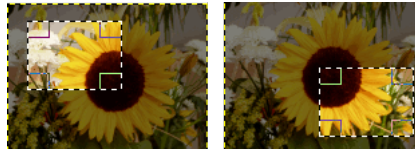
7.2.1 Moving a Selection

Rectangular and elliptical selections have two modes. The default mode has handles on the selection. If you click the selection or press the **Enter** key, the handles disappear leaving only the dotted outline (marching ants). The other selection tools have different behaviour.

7.2.1.1 Moving rectangular and elliptical selections

If you click-and drag a selection with handles, you move the selection outline, and you don’t move the contents of rectangular or elliptic selections.

Select the **Move** tool and set the options to move the selection; the tool supports moving the selection, path, or layer.

Figure 7.5 Moving selection outline

Most systems support moving the selection using the arrow keys. The precise behavior is system dependent. If the arrow keys do not cause the selection to move, try hovering the mouse cursor over the selection first. Press and hold the **Alt** (or **Ctrl-Alt**, **Shift-Alt**, or **Alt**). One combination may move the selection by one pixel, and another by 25 pixels each step. Hover the mouse cursor over a side or corner handle, and the arrow keys and combinations can change the size of the selection.

If you click-and-drag the selection without handles, you create a new selection! To move the selection contents, you have to

- hold down **Ctrl-Alt** keys and click-and-drag the selection. This makes the original place empty. A floating selection is created. The required key commands may differ on your system, look in the status bar to see if another combination is specified; for example, **Shift-Ctrl-Alt**.

Figure 7.6 Moving a selection and its content, emptying the original place

- hold down **Shift-Alt** keys and click-and-drag the selection to move without emptying the original place. A floating selection is created.

Figure 7.7 Moving a selection and its content without emptying the original place

Note



On some systems, you must push **Alt** before **Shift** or **Ctrl**. On these systems, pressing **Shift** or **Ctrl** first, causes GIMP to enter a mode that adds or subtract from the current selection — after that, the **Alt** key is ineffective!

7.2.1.2 Moving the other selections

The other selections (Lasso, Magic wand, By Color) have no handle. Click-and dragging them doesn't move them. To move their contents, as with rectangular and elliptical selections, you have to hold down **Ctrl-Alt** keys or **Shift-Alt** and click-and-drag.

If you use keyboard arrow keys instead of click-and-drag, you move the outline.

7.2.1.3 Other method

Note



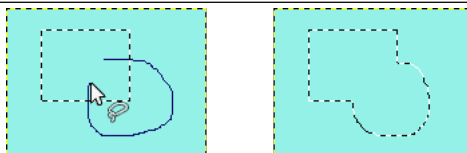
You can also use a more roundabout method to move a selection. Make it floating. Then you can move its content, emptying the origin, by click-and-dragging or keyboard arrow keys. To move without emptying, use copy-paste.

7.2.2 Adding or subtracting selections

Tools have options that you can configure. Each selection tool allows you to set the selection mode. The following selection modes are supported:

- Replace is the most used selection mode. In replace mode, a selection replaces any existing selection.
- Add mode, causes new selections to be added to any existing selection. Press and hold the **Shift** key while making a selection to temporarily enter add mode.
- Subtract mode, causes new selections to be removed from any existing selection. Press and hold the **Ctrl** key while making a selection to temporarily enter subtract mode.
- Intersect mode, causes areas in both the new and existing selection to become the new selection. Press and hold both the **Shift** and **Ctrl** key while making a selection to temporarily enter intersect mode.

Figure 7.8 Enlarging a rectangular selection with the Lasso



The figure shows an existing rectangular selection. Select the Lasso. While pressing the **Shift** key, make a free hand selection that includes the existing selection. Release the mouse button and areas are included in the selection.

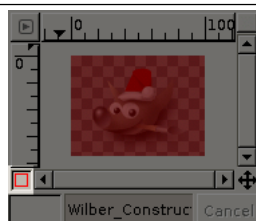
Note



To correct selection defects precisely, use the **Quick Mask**.

7.3 The QuickMask

Figure 7.9 Image with QuickMask enabled



The usual **selection tools** involve tracing an outline around an area of interest, which does not work well for some complex selections. The QuickMask, however, allows you to paint a selection instead of just tracing its outline.

7.3.1 Overview

Normally, a selection in GIMP is represented by “marching ants” that trace the selection outline, but there may be more to a selection than the marching ants show. A GIMP selection is actually a full-fledged grayscale channel, covering the image, with pixel values ranging from 0 (unselected) to 255 (fully selected). The marching ants are drawn along a contour of half-selected pixels. Thus, what the marching ants show you as either inside or outside the boundary is really just a slice through a continuum.

The QuickMask is GIMP’s way of showing the full structure of the selection. QuickMask also provides the ability to interact with the selection in new, and substantially more powerful, ways. Click the small outlined button at the lower left of the image window to toggle QuickMask on and off. The button switches between QuickMask mode, and marching ants mode. You can also use `Select → Toggle QuickMask`, or `Shift-Q`, to toggle between QuickMask and marching ants mode.

In QuickMask mode, the selection is shown as a translucent screen overlying the image, whose transparency at each pixel indicates the degree to which that pixel is selected. By default the mask is shown in red, but you can change this if another mask color is more convenient. The less a pixel is selected, the more it is obscured by the mask. Fully selected pixels are shown completely clear.

In QuickMask mode, many image manipulations act on the selection channel rather than the image itself. This includes, in particular, paint tools. Painting with white selects pixels, and painting with black unselects pixels. You can use any of the paint tools, as well as the bucket fill and gradient fill tools, in this way. Advanced users of GIMP learn that “painting the selection” is the easiest and most effective way to delicately manipulate the image.

Tip



To save a QuickMask selection to a new channel; Make sure that there is a selection and that QuickMask mode is not active in the image window. Use `Select → Save to Channel`. to create a new channel in the channel dialog called “SelectionMask copy” (repeating this command creates “..copy#1”, “...copy#2” and so on...).

Tip



In QuickMask mode, `Cut` and `Paste` act on the selection rather than the image. You can sometimes make use of this as the most convenient way of transferring a selection from one image to another.

You can learn more on **Selection masks** in the section dedicated to the channel dialog.

7.3.2 Properties

There are two QuickMask properties you can change by right-clicking on the QuickMask button.

- Normally the QuickMask shows unselected areas “fogged over ” and selected areas “in clear”, but you can reverse this by choosing “Mask Selected Areas” instead of the default “Mask Unselected Areas”.
- Use “Configure Color and Opacity” to open a dialog that allows you to set these to values other than the defaults, which are red at 50% opacity.

7.4 Using QuickMask Mode

1. Open an image or begin a new document.
2. Activate QuickMask mode using the left-bottom button in the image window. If a selection is present the mask is initialized with the content of the selection.
3. Choose any drawing tool. Paint on the QuickMask with black to remove selected areas, and paint with white to add selected areas. Use grey colors to partially select areas.
You can also use selection tools and fill these selections with the Bucket Fill tool; this does not destroy the QuickMask selections!
4. Toggle QuickMask mode off using the left-bottom button in the image window: the selection will be displayed with marching ants.

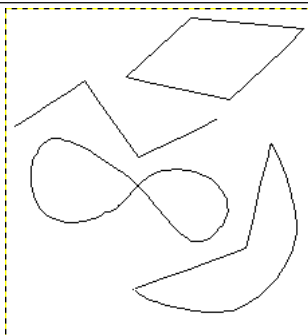
7.5 Paths

Paths are curves (known as Bézier-curves). Paths are easy to learn and use in GIMP. To understand their concepts and mechanism, look at the glossary [Bézier-curve](#) or Wikipedia [[WKPD-BEZIER](#)]. The Paths tool is very powerful, allowing you to design sophisticated forms. To use the Paths tool in GIMP, you must first create a path, and then stroke the path.

In GIMP, the term “Stroke path” means to apply a specific style to the path (color, width, pattern...). A Path has two main purposes:

- You can convert a closed path to a selection.
- Any path, open or closed, can be *stroked*; that is, painted on the image in a variety of ways.


Figure 7.10 Illustration of four different path creating



Four examples of GIMP paths: one closed and polygonal; one open and polygonal; one closed and curved; one with a mixture of straight and curved segments.

7.5.1 Path Creation

Start by drawing the outline for your path; the outline can be modified later (see the [Paths](#) tool). To start, select the Paths tool using one of the following methods:

- Use Tools → Path from the image menu.
- Use the relevant icon  in toolbox.
- Use the hotkey **B**.

When the Paths tool is selected, the mouse cursor changes into a pointer (arrow) with a curve. Left click in the image to create the first point on the path. Move the mouse to a new point and left click the mouse to create another point linked to the previous point. Although you can create as many points as you desire, you only need two points to learn about Paths. While adding points, the mouse cursor has a

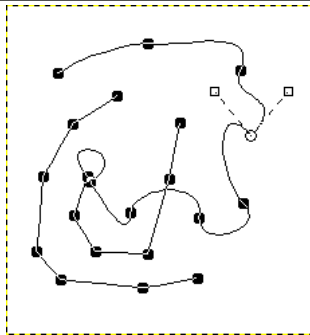
little “+” next to the curve, which indicates that clicking will add a new point. When the mouse cursor is close to a line segment, the “+” changes into a cross with arrows; like the move tool.

Move the mouse cursor close to a line segment, left-click and drag the line segment. Two events occur.

- The line segment bends and curves as it is pulled.
- Each line segment has a start point and an end point that is clearly labeled. A “direction line” now projects from each end point for the line segment that was moved.

The curved line segment leaves an end point in the same direction that the “direction line” leaves the end point. The length of the “direction line” controls how far the line segment projects along the “direction line” before curving toward the other end point. Each “direction line” has an empty square box (called a handle) on one end. Click and drag a handle to change the direction and length of a “direction line”.

Figure 7.11 Appearance of a path while it is manipulated



Appearance of a path while it is manipulated using the Path tool.

The path is comprised of two components with both straight and curved segments. Black squares are anchor points, the open circle indicates the selected anchor, and the two open squares are the handles associated with the selected anchor.

7.5.2 Path Properties

Paths, like layers and channels, are components of an image. When an image is saved in GIMP’s native XCF file format, any paths it has are saved with it. The list of paths in an image can be viewed and operated on using the **Paths dialog**. You can move a path from one image to another by copying and pasting using the pop-up menu in the Paths dialog, or by dragging an icon from the Paths dialog into the destination image window.

GIMP paths belong to a mathematical type called “Bezier paths”. What this means in practical terms is that they are defined by *anchors* and *handles*. “Anchors” are points the path goes through. “Handles” define the direction of a path when it enters or leaves an anchor point: each anchor point has two handles attached to it.

Paths can be very complex. If you create them by hand using the Path tool, unless you are obsessive they probably won’t contain more than a few dozen anchor points (often many fewer); but if you create them by transforming a selection into a path, or by transforming text into a path, the result can easily contain hundreds of anchor points, or even thousands.

A path may contain multiple *components*. A “component” is a part of a path whose anchor points are all connected to each other by path segments. The ability to have multiple components in paths allows you to convert them into selections having multiple disconnected parts.

Each component of a path can be either *open* or *closed*: “closed” means that the last anchor point is connected to the first anchor point. If you transform a path into a selection, any open components are automatically converted into closed components by connecting the last anchor point to the first anchor point with a straight line.

Path segments can be either straight or curved. A path is called “polygonal” if all of its segments are straight. A new path segment is always created straight; the handles for the anchor points are directly on top of the anchor points, yielding handles of zero length, which produces straight-line segments. Drag a handle handle away from an anchor point to cause a segment to curve.

One nice thing about paths is that they use very few resources, especially in comparison with images. Representing a path in RAM requires storing only the coordinates of its anchors and handles: 1K of memory is enough to hold a complex path, but not enough to hold a small 20x20 pixel RGB layer. Therefore, it is possible to have literally hundreds of paths in an image without causing any significant stress to your system; the amount of stress that hundreds of paths might cause *you*, however, is another question. Even a path with thousands of segments consumes minimal resources in comparison to a typical layer or channel.

Paths can be created and manipulated using the [Path tool](#).

7.5.3 Paths and Selections

GIMP lets you transform the selection for an image into a path; it also lets you transform paths into selections. For information about the selection and how it works, see the [Selection](#) section.

When you transform a selection into a path, the path closely follows the “marching ants”. Now, the selection is a two-dimensional entity, but a path is a one-dimensional entity, so there is no way to transform the selection into a path without losing information. In fact, any information about partially selected areas (i.e., feathering) are lost when a selection is turned into a path. If the path is transformed back into a selection, the result is an all-or-none selection, similar to what is obtained by executing “Sharpen” from the Select menu.

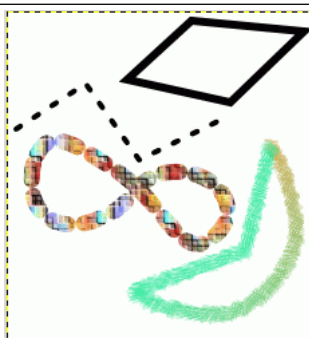
7.5.4 Transforming Paths

Each of the Transform tools (Rotate, Scale, Perspective, etc) can be set to act on a layer, selection, or path. Select the transform tool in the toolbox, then select layer, selection, or path for the “Transform:” option in the tool’s Tool Options dialog. This gives you a powerful set of methods for altering the shapes of paths without affecting other elements of the image.

By default a Transform tool, when it is set to affect paths, acts on only one path: the *active path* for the image, which is shown highlighted in the Paths dialog. You can make a transformation affect more than one path, and possibly other things as well, using the “transform lock” buttons in the Paths dialog. Not only paths, but also layers and channels, can be transform-locked. If you transform one element that is transform-locked, all others will be transformed in the same way. So, for example, if you want to scale a layer and a path by the same amount, click the transform-lock buttons so that “chain” symbols appear next to the layer in the Layers dialog, and the path in the Paths dialog; then use the Scale tool on either the layer or the path, and the other will automatically follow.

7.5.5 Stroking a Path

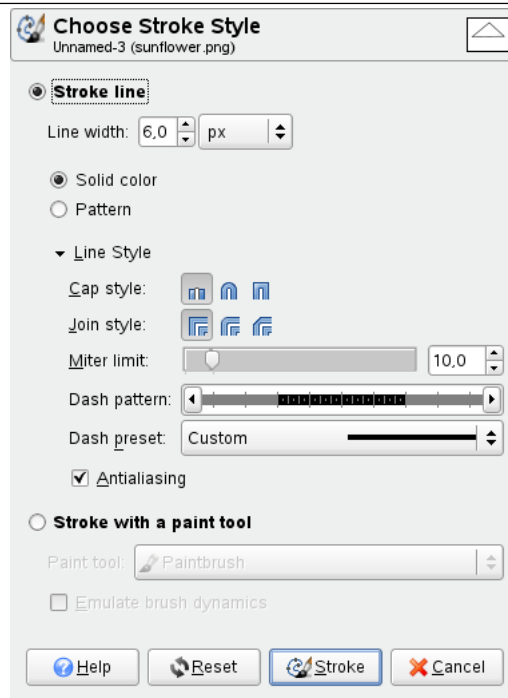
Figure 7.12 Stroking paths



The four paths from the top illustration, each stroked in a different way.

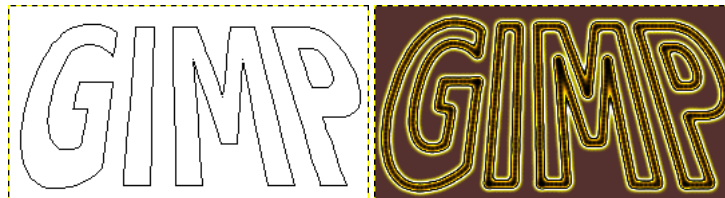
Paths do not alter the appearance of the image pixel data unless they are *stroked*, using Edit → Stroke Path from the image menu or the Paths dialog right-click menu, or the “Stroke Path” button in the Tool Options dialog for the Path tool.

Choosing “Stroke Path” by any of these means brings up a dialog that allows you to control the way the stroking is done. You can choose from a wide variety of line styles, or you can stroke with any of the Paint tools, including unusual ones such as the Clone tool, Smudge tool, Eraser, etc.

Figure 7.13 The Stroke Path dialog

You can further increase the range of stroking effects by stroking a path multiple times, or by using lines or brushes of different widths. The possibilities for getting interesting effects in this way are almost unlimited.

7.5.6 Paths and Text

Figure 7.14 Text converted to a path

(a) Text converted to a path and then transformed using the Perspective tool.

(b) The path shown above, stroked with a fuzzy brush and then gradient-mapped using the Gradient Map filter with the “Yellow Contrast” gradient.

A text item created using the Text tool can be transformed into a path using the **Path from Text** command in the the context menu of the Text tool. This can be useful for several purposes, including:

- Stroking the path, which gives you many possibilities for fancy text.
- More importantly, transforming the text. Converting text into a path, then transforming the path, and finally either stroking the path or converting it to a selection and filling it, often leads to much higher-quality results than rendering the text as a layer and transforming the pixel data.

7.5.7 Paths and SVG files

SVG, standing for “Scalable Vector Graphics”, is an increasingly popular file format for *vector graphics*, in which graphical elements are represented in a resolution-independent format, in contrast to *raster graphics*; in which graphical elements are represented as arrays of pixels. GIMP is mainly a raster graphics program, but paths are vector entities.

Fortunately, paths are represented in SVG files in almost exactly the same way they are represented in GIMP. (Actually fortune has nothing to do with it: GIMP's path handling was rewritten for GIMP 2.0 with SVG paths in mind.) This compatibility makes it possible to store GIMP paths as SVG files without losing any information. You can access this capability in the Paths dialog.

It also means that GIMP can create paths from SVG files saved in other programs, such as Inkscape or Sodipodi, two popular open-source vector graphics applications. This is nice because those programs have much more powerful path-manipulation tools than GIMP does. You can import a path from an SVG file using the Paths dialog.

The SVG format handles many other graphical elements than just paths: among other things, it handles figures such as squares, rectangles, circles, ellipses, regular polygons, etc. GIMP cannot do anything with these entities, but it can load them as paths.

Note



Creating paths is not the only thing GIMP can do with SVG files. It can also open SVG files as GIMP images, in the usual way.

7.6 Brushes

Figure 7.15 Brush strokes example



A number of examples of brushstrokes painted using different brushes from the set supplied with GIMP. All were painted using the Paintbrush tool.

A *brush* is a pixmap or set of pixmaps used for painting. GIMP includes a set of 10 “paint tools”, which not only perform operations that you would normally think of as painting, but also operations such as erasing, copying, smudging, lightening or darkening, etc. All of the paint tools, except the ink tool, use the same set of brushes. The brush pixmaps represent the marks that are made by single “touches” of the brush to the image. A brush stroke, usually made by moving the pointer across the image with the mouse button held down, produces a series of marks spaced along the trajectory, in a way specified by the characteristics of the brush and the paint tool being used.

Brushes can be selected by clicking on an icon in the **Brushes dialog**. GIMP's *current brush* is shown in the Brush/Pattern/Gradient area of the Toolbox. Clicking on the brush symbol there is one way of activating the Brushes dialog.

When you install GIMP, it comes with a number of basic brushes, plus a few bizarre ones that serve mainly to give you examples of what is possible (i. e., the “green pepper” brush in the illustration). You can also create new brushes, or download them and install them so that GIMP will recognize them.

GIMP can use several different types of brushes. All of them, however, are used in the same way, and for most purposes you don't need to worry about the differences when you paint with them. Here are the available types of brushes:

Ordinary brushes Most of the brushes supplied with GIMP fall into this category. They are represented in the Brushes dialog by grayscale pixmaps. When you paint using them, the current foreground

color (as shown in the Color Area of the Toolbox) is substituted for black, and the pixmap shown in the brushes dialog represents the mark that the brush makes on the image.

To create such a brush: Create a small image in gray levels using zoom. Save it with the `.gbr` extension. Click on Refresh button in the Brush Dialog to get it in preview without it being necessary to restart GIMP.

Color brushes Brushes in this category are represented by colored images in the Brushes dialog. They can be pictures or text. When you paint with them, the colors are used as shown; the current foreground color does not come into play. Otherwise they work the same way as ordinary brushes.

To create such a brush: Create a small RGBA image. For this, open New Image, select RGB for image type and Transparent for fill type. Draw your image and first save it as an `.xcf` file to keep its properties. Then save it in `.gbr` format. Click on the *Refresh* button in Brush Dialog to get your brush without it being necessary to restart GIMP.

Tip



When you do a Copy or a Cut on a selection, you see the contents of the clipboard (that is the selection) at the first position in the brushes dialog. And you can use it for painting.

Figure 7.16 Selection to Brush after Copy or Cut

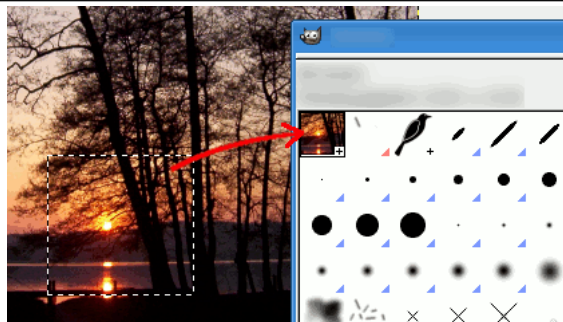


Image hoses / Image pipes Brushes in this category can make more than one kind of mark on an image. They are indicated by small red triangles at the lower right corner of the brush symbol in the Brushes dialog. They are sometimes called “animated brushes” because the marks change as you trace out a brushstroke. In principle, image hose brushes can be very sophisticated, especially if you use a tablet, changing shape as a function of pressure, angle, etc. These possibilities have never really been exploited, however; and the ones supplied with GIMP are relatively simple (but still quite useful).

You will find an example on how to create such brushes in [Animated brushes](#)

Parametric brushes These are brushes created using the [Brush Editor](#), which allows you to generate a wide variety of brush shapes by using a simple graphical interface. A nice feature of parametric brushes is that they are *resizable*. It is possible, using the Preferences dialog, to make key presses or mouse wheel rotations cause the current brush to become larger or smaller, if it is a parametric brush.

Now, all brushes have a variable size. In fact, in the option box of all painting tools there is a slider to enlarge or reduce the size of the active brush. You can do this directly in the image window if you have set correctly your mouse wheel; see [Varying brush size](#).

In addition to the brush pixmap, each GIMP brush has one other important property: the brush *Spacing*. This represents the distance between consecutive brush-marks when a continuous brushstroke is painted. Each brush has an assigned default value for this, which can be modified using the Brushes dialog.

Note



GIMP-2.10 can use MyPaint brushes. Please refer to Section 14.3.8 for more information.

7.7 Adding New Brushes

Note

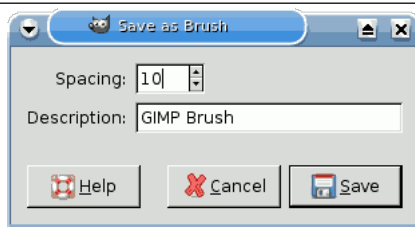


There is a quick method to add a new brush: Section 7.9.2.

To add a new brush, after either creating or downloading it, you need to save it in a format GIMP can use. The brush file needs to be placed in the GIMP's brush search path, so that GIMP is able to index and display it in the Brushes dialog. You can hit the Refresh button, which reindexes the brush directory. GIMP uses three file formats for brushes:

GBR The `.gbr` ("gimp brush") format is used for ordinary and color brushes. You can convert many other types of images, including many brushes used by other programs, into GIMP brushes by opening them in GIMP and saving them with file names ending in `.gbr`. This brings up a dialog box in which you can set the default Spacing for the brush. A more complete description of the GBR file format can be found in the file `gbr.txt` in the `devel-docs` directory of the GIMP source distribution.

Figure 7.17 Save a `.gbr` brush



GIH The `.gih` ("gimp image hose") format is used for animated brushes. These brushes are constructed from images containing multiple layers: each layer may contain multiple brush-shapes, arranged in a grid. When you save an image as a `.gih` file, a dialog comes up that allows you to describe the format of the brush. Look at [The GIH dialog box](#) for more information about the dialog. The GIH format is rather complicated: a complete description can be found in the file `gih.txt` in the `devel-docs` directory of the GIMP source distribution.

VBR The `.vbr` format is used for parametric brushes, i. e., brushes created using the Brush Editor. There is really no other meaningful way of obtaining files in this format.

MYB The `.myb` format is used for MyPaint brushes. Please refer to Section 14.3.8 for more information.

To make a brush available, place it in one of the folders in GIMP's brush search path. By default, the brush search path includes two folders, the system `brushes` folder, which you should not use or alter, and the `brushes` folder inside your personal GIMP directory. You can add new folders to the brush search path using the [Brush Folders](#) page of the Preferences dialog. Any GBR, GIH, or VBR file included in a folder in the brush search path will show up in the Brushes dialog the next time you start GIMP, or as soon as you press the Refresh button in the Brushes dialog.

Note

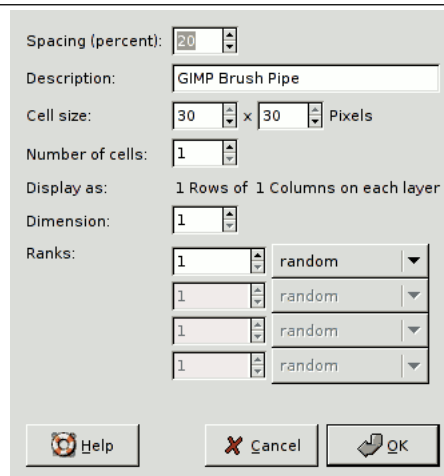
When you create a new parametric brush using the Brush Editor, it is automatically saved in your personal `brushes` folder.

There are a number of web sites with downloadable collections of GIMP brushes. Rather than supplying a list of links that will soon be out of date, the best advice is to do a search with your favorite search engine for “GIMP brushes”. There are also many collections of brushes for other programs with painting functionality. Some can be converted easily into GIMP brushes, some require special conversion utilities, and some cannot be converted at all. Most fancy procedural brush types fall into the last category. If you need to know, look around on the web, and if you don’t find anything, look for an expert to ask.

7.8 The GIH Dialog Box

When your new animated brush is created, it is displayed within the image window and you would like save it into a gih format. You select File → Save as... menu, name your work with the gih extension in the new window relevant field and as soon as you pressed the Save button, the following window is displayed:

Figure 7.18 The dialog to describe the animated brush



This dialog box shows up, if you save an image as GIMP image hose

This dialog box has several options not easy to understand. They allow you to determine the way your brush is animated.

Spacing (Percent) “Spacing” is the distance between consecutive brush marks when you trace out a brushstroke with the pointer. You must consider drawing with a brush, whatever the paint tool, like stamping. If Spacing is low, stamps will be very close and stroke look continuous. If spacing is high, stamps will be separated: that’s interesting with a color brush (like “green pepper” for instance). Value varies from 1 to 200 and this percentage refers to brush “diameter”: 100% is one diameter.

Description It’s the brush name that will appear at the top of Brush Dialog (grid mode) when the brush is selected.

Cell Size That’s size of cells you will cut up in layers... Default is one cell per layer and size is that of the layer. Then there is only one brush aspect per layer.

We could have only one big layer and cut up in it the cells that will be used for the different aspects of the animated brush.

For instance, we want a 100x100 pixels brush with 8 different aspects. We can take these 8 aspects from a 400x200 pixels layer, or from a 300x300 pixels layer but with one cell unused.

Number of cells That's the number of cells (one cell per aspect) that will be cut in every layer. Default is the number of layers as there is only one layer per aspect.

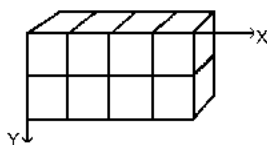
Display as This tells how cells have been arranged in layers. If, for example, you have placed height cells at the rate of two cells per layer on four layers, GIMP will display: 1 rows of 2 columns on each layer.

Dimension, Ranks, Selection There things are getting complicated! Explanations are necessary to understand how to arrange cell and layers.

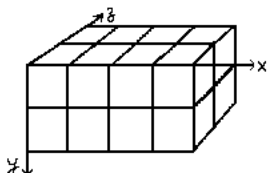
GIMP starts retrieving cells from each layer and stacks them into a FIFO stack (First In First Out: the first in is at the top of the stack and so can be first out). In our example 4 layers with 2 cells in each, we'll have, from top to bottom: first cell of first layer, second cell of first layer, first cell of second layer, second cell of second layer..., second cell of fourth layer. With one cell per layer or with several cells per layer, result is the same. You can see this stack in the Layer Dialog of the resulting .gih image file.

Then GIMP creates a computer array from this stack with the Dimensions you have set. You can use four dimensions.

In computer science an array has a "myarray(x,y,z)" form for a 3 dimensions array (3D). It's easy to imagine a 2D array: on a paper it's an array with rows and columns



With a 3d array we don't talk rows and columns but Dimensions and Ranks. The first dimension is along x axis, the second dimension along y axis, the third along z axis. Each dimension has ranks of cells.



To fill up this array, GIMP starts retrieving cells from the top of stack. The way it fills the array reminds that of an odometer: right rank digits turn first and, when they reach their maximum, left rank digits start running. If you have some memories of Basic programming you will have, with an array(4,2,2), the following succession: (1,1,1),(1,1,2),(1,2,1),(1,2,2),(2,1,1),(2,1,2),(2,2,2),(3,1,1).... (4,2,2). We will see this later in an example.

Besides the rank number that you can give to each dimension, you can also give them a Selection mode. You have several modes that will be applied when drawing:

Incremental GIMP selects a rank from the concerned dimension according to the order ranks have in that dimension.

Random GIMP selects a rank at random from the concerned dimension.

Angular GIMP selects a rank in the concerned dimension according to the moving angle of the brush.

The first rank is for the direction 0°, upwards. The other ranks are affected, clockwise, to an angle whose value is 360/number of ranks. So, with 4 ranks in the concerned dimension, the angle will move 90° clockwise for each direction change: second rank will be affected to 90° (rightwards), third rank to 180° (downwards) and fourth rank to 270° (-90°) (leftwards).¹

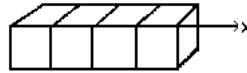
¹For previous GIMP versions you may have to replace "clockwise" with "counter-clockwise".

Speed, Pressure, x tilt, y tilt These options are for sophisticated drawing tablets.

Examples

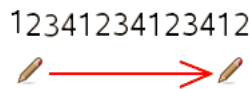
A one dimension image pipe Well! What is all this useful for? We'll see that gradually with examples. You can actually place in each dimension cases that will give your brush a particular action.

Let us start with a 1D brush which will allow us to study selection modes action. We can imagine it like this:



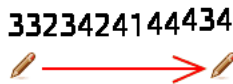
Follow these steps:

1. Open a new 30x30 pixels image, RGB with Transparent fill type. Using the Text tool create 4 layers "1", "2", "3", "4". Delete the "background" layer.
2. Save this image first with .xcf extension to keep its properties then save it as .gih.
3. The Save As Dialog is opened: select a destination for your image. OK. The GIH dialog is opened: Choose Spacing 100, give a name in Description box, 30x30 for Cell Size, 1 dimension, 4 ranks and choose "Incremental" in Selection box. OK.
4. You may have difficulties to save directly in the GIMP Brush directory. In that case, save the .gih file manually into the /usr/share/gimp/gimp/2.0/brushes directory. Then come back into the Toolbox, click in the brush icon to open the Brush Dialog then click on Refresh icon button. Your new brush appears in the Brush window. Select it. Select pencil tool for instance and click and hold with it on a new image:



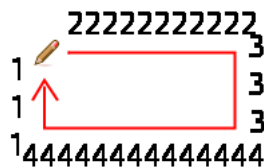
You see 1, 2, 3, 4 digits following one another in order.

5. Take your .xcf image file back and save it as .gih setting Selection to "Random":



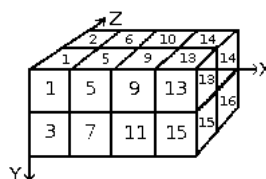
Digits will be displayed at random order.

6. Now select "Angular" Selection:



A 3 dimensions image hose We are now going to create a 3D animated brush: its orientation will vary according to brush direction, it will alternate Left/Right hands regularly and its color will vary at random between black and blue.

The first question we have to answer to is the number of images that is necessary. We reserve the first dimension (x) to the brush direction (4 directions). The second dimension (y) is for Left/Right alternation and the third dimension (z) for color variation. Such a brush is represented in a 3D array "myarray(4,2,2)":



There are 4 ranks in first dimension (x), 2 ranks in second dimension (y) and 2 ranks in third dimension (z). We see that there are $4 \times 2 \times 2 = 16$ cells. We need 16 images.

1. Creating images of dimension 1 (x)

Open a new 30x30 pixels image, RGB with Transparent Fill Type. Using the zoom draw a left hand with fingers upwards.² Save it as `handL0k.xcf` (hand Left 0° Black).

Open the Layer Dialog. Double click on the layer to open the Layer Attributes Dialog and rename it to `handL0k`.

Duplicate the layer. Let visible only the duplicated layer, select it and apply a 90° rotation (Layer/Transform/ 90° rotation clockwise). Rename it to `handL90k`.

Repeat the same operations to create `handL180k` and `handL-90k` (or `handL270k`).

2. Creating images of dimension 2 (y)

This dimension in our example has two ranks, one for left hand and the other for right hand. The left hand rank exists yet. We shall build right hand images by flipping it horizontally.

Duplicate the `handL0k` layer. Let it visible only and select it. Rename it to `handR0k`. Apply Layer/Transform/Flip Horizontally.

Repeat the same operation on the other left hand layers to create their right hand equivalent.

Re-order layers to have a clockwise rotation from top to bottom, alternating Left and Right: `handL0k`, `handR0k`, `handL90k`, `handR90k`, ..., `handR-90k`.

3. Creating images of dimension 3 (z)

Creating images of dimension 3 (z): The third dimension has two ranks, one for black color and the other for blue color. The first rank, black, exists yet. We will see that images of dimension 3 will be a copy, in blue, of the images of dimension 2. So we will have our 16 images. But a row of 16 layers is not easy to manage: we will use layers with two images.

Select the `handL0k` layer and let it visible only. Using Image/Canvas Size change canvas size to 60x30 pixels.

Duplicate `hand0k` layer. On the copy, fill the hand with blue using Bucket Fill tool.

Now, select the Move tool. Double click on it to accede to its properties: check Move the Current Layer option. Move the blue hand into the right part of the layer precisely with the help of Zoom.

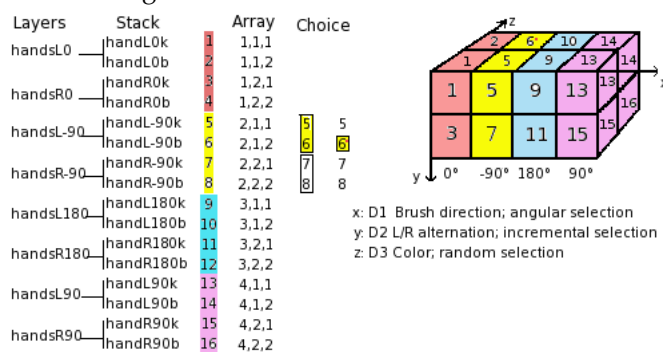
Make sure only `handL0k` and its blue copy are visible. Right click on the Layer Dialog: Apply the Merge Visible Layers command with the option Expand as Necessary. You get a 60x30 pixels layer with the black hand on the left and the blue hand on the right. Rename it to “`handsL0`”.

Repeat the same operations on the other layers.

4. Set layers in order

Layers must be set in order so that GIMP can find the required image at some point of using the brush. Our layers are yet in order but we must understand more generally how to have them in order. There are two ways to imagine this setting in order. The first method is mathematical: GIMP divides the 16 layers first by 4; that gives 4 groups of 4 layers for the first dimension. Each group represents a direction of the brush. Then, it divides each group by 2; that gives 8 groups of 2 layers for the second dimension: each group represents a L/R alternation. Then another division by 2 for the third dimension to represent a color at random between black and blue.

The other method is visual, by using the array representation. Correlation between two methods is represented in next image:



²Ok, we are cheating here: our hand is borrowed from http://commons.wikimedia.org/wiki/File:Stop_hand.png.

How will GIMP read this array?: GIMP starts with the first dimension which is programmed for “angular”, for instance 90°. In this 90° rank, in yellow, in the second dimension, it selects a L/R alternation, in an “incremental” way. Then, in the third dimension, in a random way, it chooses a color. Finally, our layers must be in the following order:

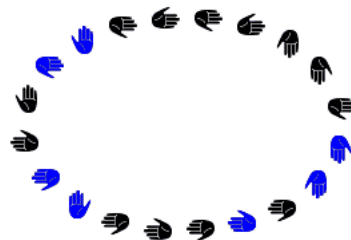


5. Voilà. Your brush is ready. Save it as `.xcf` first, then as `.gih` with the following parameters:

- Spacing: 100
- Description: Hands
- Cell Size: 30x30
- Number of cells: 16
- Dimensions: 3
 - Dimension 1: 4 ranks Selection: Angular
 - Dimension 2: 2 ranks Selection: Incremental
 - Dimension 3: 2 ranks Selection: Random

Place your `.gih` file into GIMP brush directory and refresh the brush box. You can now use your brush.

Figure 7.19 Here is the result by stroking an elliptical selection with the brush:



This brush alternates right hand and left hand regularly, black and blue color at random, direction according to four brush directions.

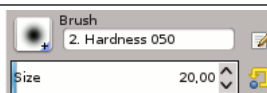
7.9 Changing brush size

Since GIMP 2.4, all brushes have a variable size that can be changed.

7.9.1 How to change the size of a brush

You can change the brush size in several ways:

1. Using the Size slider of the tool options. Pencil, Paintbrush, Eraser, Airbrush, Clone, Heal, Perspective Clone, Blur/Sharpen and Dodge/Burn tools have a slider to vary the brush size.

Figure 7.20 The Size slider

2. By using the default shortcut keys for changing a tool's size:

- Decrease size by 1: [
- Increase size by 1:]
- Decrease size by 10: {
- Increase size by 10: }

3. By using the default mouse scrollwheel actions for changing a tool's size:

- Decrease size by 1: Ctrl-Alt-Scrollwheel Down
- Increase size by 1: Ctrl-Alt-Scrollwheel Up

4. By programming the mouse wheel:

- (a) In the main window of GIMP, click on Edit → Preferences.
- (b) In the left column of the new window, select Input Devices → Input Controllers.
- (c) You can see Additional Input Controllers, with two columns: Available Controllers and Active Controllers.
In the column Active Controllers, double-click the Main Mouse Wheel button.
- (d) Then, you see a new window: Configure Input Controller.
In the left column Event, click Scroll Up to get it highlighted.
- (e) Click the Edit button (at the bottom middle of the list).
- (f) You can see the window Select Controller Event Action.
Drop-down the Tools item, by clicking the small triangle on its left.
- (g) In the left column Action, click Tool's Size: Increase Relative to highlight it, then click the OK button.
- (h) Now, in front of Scroll Up is display tools-size-increase-percent.
- (i) Close the window.
- (j) With the same method, program Scroll Down with Tool's Size: Decrease Relative.
- (k) Don't forget to click the OK button of the main window of Preferences.

After these somewhat long explanations, you can use your mouse wheel to vary size brush. For example, choose the pencil tool with the "Circle" brush. Set the pointer in the image window, use the mouse wheel, in the two directions, you can see the "Circle" shrinking or stretching.

5. You can program the "Up" and "Down" arrow keys of the keyboard.

The method is similar to that of the mouse wheel. The only differences are:

- In the column Active Controllers, double-click Main Keyboard.
- In the column Event, click Cursor Up for the first key, and Cursor Down for the second key.
- Then, use the two keys (Up arrow and Down arrow) and the result is the same as you got with the mouse wheel.

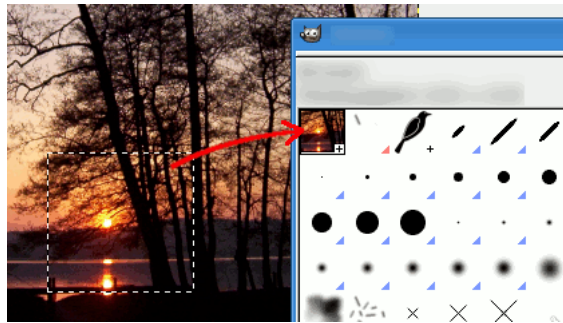
7.9.2 Creating a brush quickly

Two methods to create a new brush easily:

1. First, the “superfast” method. You have an image area you want make a brush from it, to be used with a tool like pencil, airbrush... Select it with the rectangular (or elliptical) select tool, then do a Copy of this selection and immediately you can see this copy in the first position of the Brush Dialog, and its name is “Clipboard”. It is immediately usable.

This brush is temporary: it disappears when you close GIMP. With GIMP-2.10, you can make it permanent by clicking on the Duplicate this brush at the bottom of the brush panel.

Figure 7.21 Selection becomes a brush after copying




2. The second method is more elaborate.

Do File → New with, for example, a width and a length of 35 pixels and in the advanced options a Color Space in Gray Level and Fill with: white.

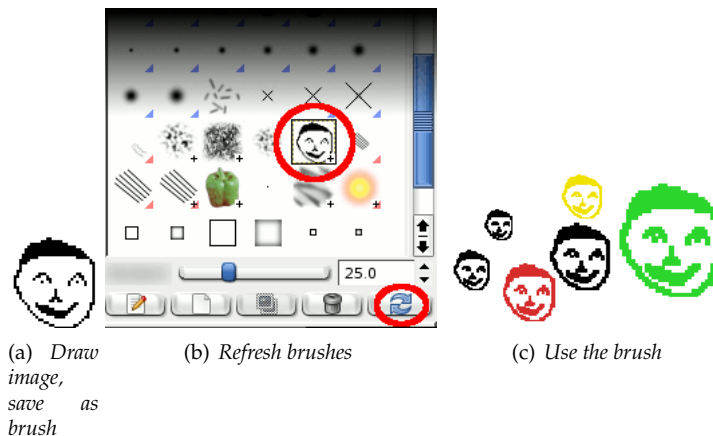
Zoom on this new image to enlarge it and draw on it with a black pencil.

Save it with a .gbr extension in the directory `/home/name_of_user/.config/GIMP/2.10/brushes/`.

In the Brushes dialog window, click on the button Refresh brushes .

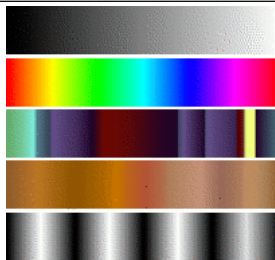
And your marvellous brush appears right in the middle of the other brushes. You can use it immediately, without starting GIMP again.

Figure 7.22 Steps to create a brush



7.10 Gradients

Figure 7.23 Some examples of GIMP gradients.



Gradients from top to bottom: FG to BG (RGB); Full saturation spectrum; Nauseating headache; Browns; Four bars

A *gradient* is a set of colors arranged in a linear order. The most basic use of gradients is by the **Gradient tool**, sometimes known as “gradient fill tool”: it works by filling the selection with colors from a gradient. You have many options to choose from for controlling the way the gradient colors are arranged within the selection. There are also other important ways to use gradients, including:

Painting with a gradient Each of GIMP’s basic painting tools allows you the option of using colors from a gradient. This enables you to create brushstrokes that change color from one end to the other.

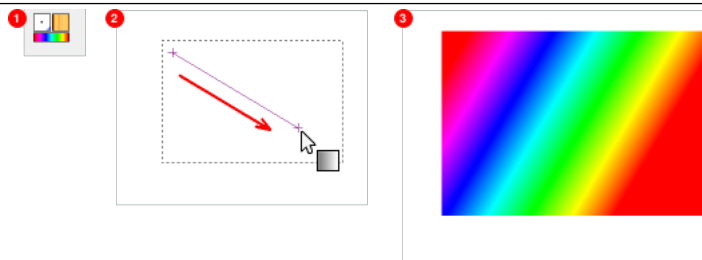
The Gradient Map filter This filter is now in the Colors menu, and allows you to “colorize” an image, using the color intensity of each point with the corresponding color from the active gradient (the intensity 0, very dark, is replaced by the color at most left end of the gradient, progressively until the intensity is 255, very light, replaced by the most right color of the gradient. See Section 16.8.38 for more information.

When you install GIMP, it comes presupplied with a large number of interesting gradients, and you can add new ones that you create or download from other sources. You can access the full set of available gradients using the **Gradients dialog**, a dockable dialog that you can either activate when you need it, or keep around as a tab in a dock. The “current gradient”, used in most gradient-related operations, is shown in the Brush/Pattern/Gradient area of the Toolbox. Clicking on the gradient symbol in the Toolbox is an alternative way of bringing up the Gradients dialog.

Many quickly examples of working with gradient (for more information see **Gradient Tool**):

- Put a gradient in a selection:
 1. Choose a gradient.
 2. With the Blend Tool click and drag with the mouse between two points of a selection.
 3. Colors will distributed perpendicularly to the direction of the drag of the mouse and according to the length of it.

Figure 7.24 How to use rapidly a gradient in a selection



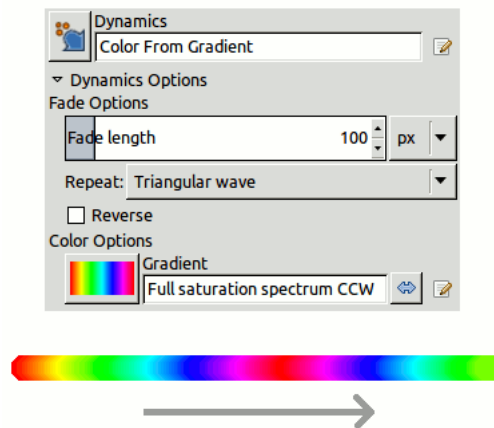
- Painting with a gradient:

You can also use a gradient with the Pencil, Paintbrush or Airbrush tools if you choose the dynamics Color From Gradient. In the next step choose a suitable gradient from Color options and in the

Fade options set the gradients length and the style of the repeating. The chapter Section 14.3.2.6 describes these parameters in more detail.

The following example shows the impact on the Pencil tool. You see in the upper side of the figure the necessary settings and the lower side of the figure shows the resulting succession of the gradients colors.

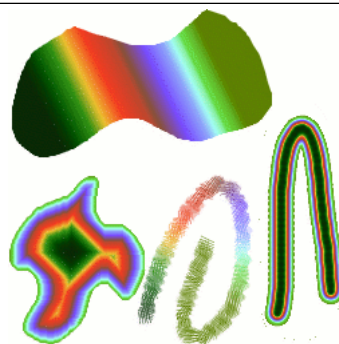
Figure 7.25 How to use rapidly a gradient with a drawing tool



To use the Paint tools with the same settings as they were known as option Use color from gradient in GIMP up to version 2.6 open the **Tool Presets Dialog**. Then choose one of the items Airbrush (Color From Gradient), Paintbrush (Color From Gradient) or Pencil (Color From Gradient) from it.

- Different productions with the same gradient:

Figure 7.26 Gradient usage



*Four ways of using the Tropical Colors gradient: a linear gradient fill, a shaped gradient fill, a stroke painted using colors from a gradient, and a stroke painted with a fuzzy brush then colored using the **Gradient Map** filter.*

A few useful things to know about GIMP's gradients:

- The first four gradients in the list are special: they use the Foreground and Background colors from the Toolbox Color Area, instead of being fixed. FG to BG (RGB) is the RGB representation of the gradient from the Foreground color to the Background color in Toolbox. FG to BG (HSV counter-clockwise) represents the hue succession in Color Circle from the selected hue to 360°. FG to BG (HSV clockwise) represents the hue succession in Color Circle from the selected hue to 0°. With FG to transparent, the selected hue becomes more and more transparent. You can modify these colors by using the Color Selector. Thus, by altering the foreground and background colors, you can make these gradients transition smoothly between any two colors you want.
- Gradients can involve not just color changes, but also changes in opacity. Some of the gradients are completely opaque; others include transparent or translucent parts. When you fill or paint with a non-opaque gradient, the existing contents of the layer will show through behind it.

- You can create new *custom* gradients, using the **Gradient Editor**. You cannot modify the gradients that are supplied with GIMP, but you can duplicate them or create new ones, and then edit those.

The gradients that are supplied with GIMP are stored in a system `gradients` folder. By default, gradients that you create are stored in a folder called `gradients` in your personal GIMP directory. Any gradient files (ending with the extension `.ggr`) found in one of these folders, will automatically be loaded when you start GIMP. You can add more directories to the gradient search path, if you want to, in the Gradients tab of the **Data Folders** pages of the Preferences dialog.

New in GIMP 2.2 is the ability to load gradient files in SVG format, used by many vector graphics programs. To make GIMP load an SVG gradient file, all you need to do is place it in the `gradients` folder of your personal GIMP directory, or any other folder in your gradient search path.

Tip



You can find a large number of interesting SVG gradients on the web, in particular at OpenClipArt Gradients [[OPENCLIPART-GRADIENT](#)]. You won't be able to see what these gradients look like unless your browser supports SVG, but that won't prevent you from downloading them.

7.11 Patterns

A *pattern* is an image, usually small, used for filling regions by *tiling*, that is, by placing copies of the pattern side by side like ceramic tiles. A pattern is said to be *tileable* if copies of it can be adjoined left-edge-to-right-edge and top-edge-to-bottom-edge without creating obvious seams. Not all useful patterns are tileable, but tileable patterns are nicest for many purposes. (A *texture*, by the way, is the same thing as a pattern.)

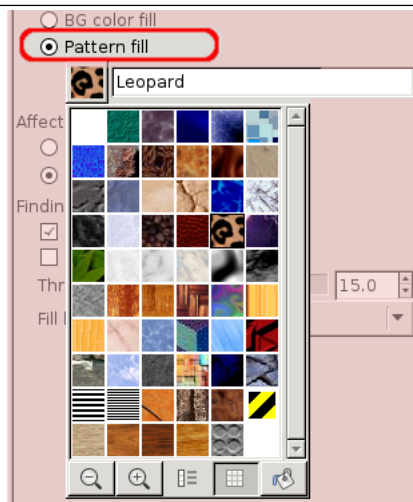
Figure 7.27 Pattern usage



Three ways of using the “Leopard” pattern: bucket-filling a selection, painting with the Clone tool, and stroking an elliptical selection with the pattern.

In GIMP there are three main uses for patterns:

- With the **Bucket Fill** tool, you can choose to fill a region with a pattern instead of a solid color.

Figure 7.28 The checked box for use a pattern

The box for pattern fill is checked and a click on the pattern shows you all patterns in grid mode.

- With the **Clone** tool, you can paint using a pattern, with a wide variety of paintbrush shapes.
- When you *stroke* a path or selection, you can do it with a pattern instead of a solid color. You can also use the Clone tool as your choice if you stroke the selection using a painting tool.

Tip



Note: Patterns do not need to be opaque. If you fill or paint using a pattern with translucent or transparent areas, then the previous contents of the area will show through from behind it. This is one of many ways of doing “overlays” in GIMP.

When you install GIMP, it comes presupplied with a few dozen patterns, which seem to have been chosen more or less randomly. You can also add new patterns, either ones you create yourself, or ones you download from the vast number available online.

GIMP's *current pattern*, used in most pattern-related operations, is shown in the Brush/Pattern/Gradient area of the Toolbox. Clicking on the pattern symbol brings up the **Patterns dialog**, which allows you to select a different pattern. You can also access the Patterns dialog by menu, or dock it so that it is present continuously.

To add a new pattern to the collection, so that it shows up in the Patterns dialog, you need to save it in a format GIMP can use, in a folder included in GIMP's pattern search path. There are several file formats you can use for patterns:

PAT The `.pat` format is used for patterns which were created specifically for GIMP. You can convert any image into a `.pat` file by opening it in GIMP and then saving it using a file name ending in `.pat`.

Caution



Do not confuse GIMP-generated `.pat` files with files created by other programs (e.g. Photoshop) – after all, `.pat` is just a part of an (arbitrary) file name.

(However, GIMP *does* support Photoshop `.pat` files until a certain version.)

PNG, JPEG, BMP, GIF, TIFF Since GIMP 2.2 you can use `.png`, `.jpg`, `.bmp`, `.gif`, or `.tiff` files as patterns.

To make a pattern available, you place it in one of the folders in GIMP's pattern search path. By default, the pattern search path includes two folders, the system `patterns` folder, which you should not use or alter, and the `patterns` folder inside your personal GIMP directory. You can add new folders to the pattern search path using the [Pattern Folders](#) page of the Preferences dialog. Any PAT file (or, in GIMP 2.2, any of the other acceptable formats) included in a folder in the pattern search path will show up in the Patterns dialog the next time you start GIMP.

Note



You can add a new pattern quickly as you do for brushes. See [Section 7.9.2](#).

There are countless ways of creating interesting pattern images in GIMP, using the wide variety of available tools and filters -- particularly the rendering filters. You can find tutorials for this in many locations, including the GIMP home page [[GIMP](#)]. Some of the filters have options that allows you to make their results tileable. Also, see [Section 17.3.10](#), this filter allows you to blend the edges of an image in order to make it more smoothly tileable.

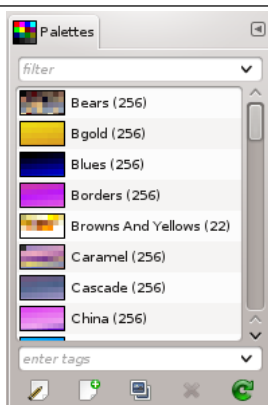
7.12 Palettes

A *palette* is a set of discrete colors. In GIMP, palettes are used mainly for two purposes:

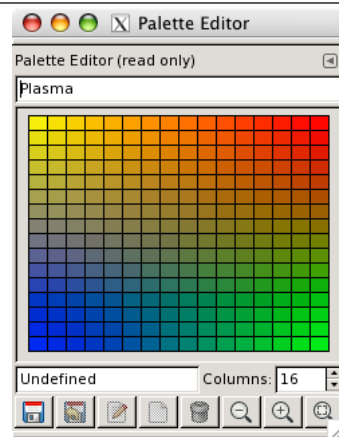
- They allow you to paint with a selected set of colors, in the same way an oil painter works with colors from a limited number of tubes.
- They form the colormaps of indexed images. An indexed image can use a maximum of 256 different colors, but these can be any colors. The colormap of an indexed image is called an "indexed palette" in GIMP.

Actually neither of these functions fall very much into the mainstream of GIMP usage: it is possible to do rather sophisticated things in GIMP without ever dealing with palettes. Still, they are something that an advanced user should understand, and even a less advanced user may need to think about them in some situations, as for example when working with GIF files.

Figure 7.29 The Palettes dialog



When you install GIMP, it comes supplied with several dozen predefined palettes, and you can also create new ones. Some of the predefined palettes are commonly useful, such as the "Web" palette, which contains the set of colors considered "web safe"; many of the palettes seem to have been chosen more or less whimsically. You can access all of the available palettes using the [Palettes dialog](#). This is also the starting point if you want to create a new palette.

Figure 7.30 The Palette Editor

Double-clicking on a palette in the Palettes dialog brings up the **Palette Editor**, showing the colors from the palette you clicked on. You can use this to paint with the palette: clicking on a color sets GIMP's foreground to that color, as shown in the Color Area of the Toolbox. Holding down the **Ctrl** key while clicking, on the other hand, sets GIMP's background color to the color you click on.

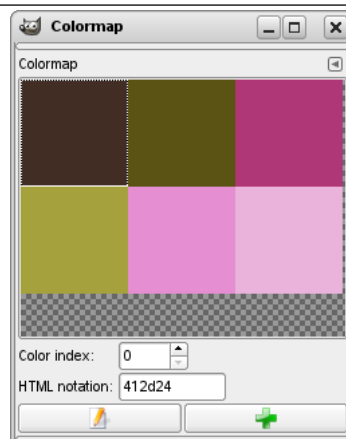
You can also, as the name implies, use the Palette Editor to change the colors in a palette, so long as it is a palette that you have created yourself. You cannot edit the palettes that are supplied with GIMP; however you can duplicate them and then edit the copies.

When you create palettes using the Palette Editor, they are automatically saved as soon as you exit GIMP, in the `palettes` folder of your personal GIMP directory. Any palette files in this directory, or in the system `palettes` directory created when GIMP is installed, are automatically loaded and shown in the Palettes dialog the next time you start GIMP. You can also add other folders to the palette search path using the **Palette Folders** page of the Preferences dialog.

GIMP palettes are stored using a special file format, in files with the extension `.gpl`. It is a very simple format, and they are ASCII files, so if you happen to obtain palettes from another source, and would like to use them in GIMP, it probably won't be very hard to convert them: just take a look at any `.gpl` and you will see what to do.

7.12.1 Colormap

Confusingly, GIMP makes use of two types of palettes. The more noticeable are the type shown in the Palettes dialog: palettes that exist independently of any image. The second type, *indexed palettes*, form the colormaps of indexed images. Each indexed image has its own private indexed palette, defining the set of colors available in the image: the maximum number of colors allowed in an indexed palette is 256. These palettes are called "indexed" because each color is associated with an index number. (Actually, the colors in ordinary palettes are numbered as well, but the numbers have no functional significance.)

Figure 7.31 The Colormap dialog

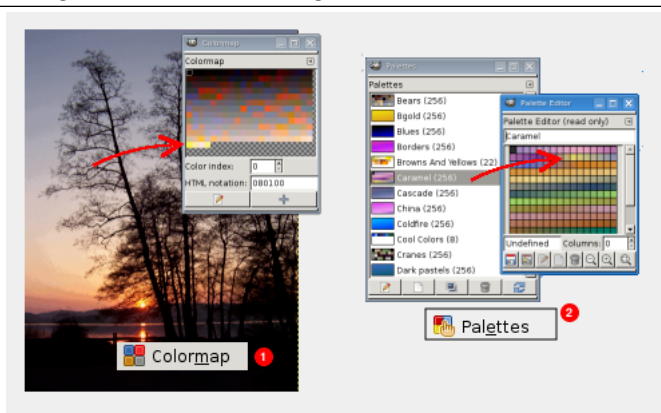
The colormap of an indexed image is shown in the **Indexed Palette dialog**, which should not be confused with the Palettes dialog. The Palettes dialog shows a list of all of the palettes available; the Colormap dialog shows the colormap of the currently active image, if it is an indexed image – otherwise it shows nothing.

You can, however, create an ordinary palette from the colors in an indexed image—actually from the colors in any image. To do this, choose Import Palette from the right-click popup menu in the Palettes dialog: this pops up a dialog that gives you several options, including the option to import the palette from an image. (You can also import any of GIMP’s gradients as a palette.) This possibility becomes important if you want to create a set of indexed images that all use the same set of colors.

When you convert an image into indexed mode, a major part of the process is the creation of an indexed palette for the image. How this happens is described in detail in Section 16.6.6. Briefly, you have several methods to choose from, one of which is to use a specified palette from the Palettes dialog.

Thus, to sum up the foregoing, ordinary palettes can be turned into indexed palettes when you convert an image into indexed mode; indexed palettes can be turned into ordinary palettes by importing them into the Palettes dialog.

Figure 7.32 Colormap dialog (1) and Palette dialog (2)

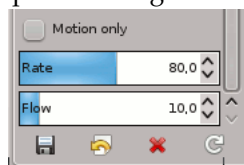


7.13 Presets

If you often use tools with particular settings, presets are for you. You can save these settings and get them back when you want.

Paint tools, which are normally in Toolbox, have a preset system that have been much improved with GIMP-2.8. Color tools (except Posterize and Desaturate), which are not normally in Toolbox, have their own preset system.

Four buttons at the bottom of all tools options dialogs allow you to save, restore, delete or reset presets.



Paint tool presets are described in Section 15.5.1.

7.14 Drawing Simple Objects

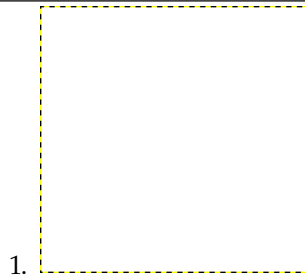
In this section, you will learn how to create simple objects in GIMP. It’s pretty easy once you figure out how to do it. GIMP provides a huge set of **Tools** and Shortcuts which most new users get lost in.

7.14.1 Drawing a Straight Line

Let’s begin by painting a straight line. The easiest way to create a straight line is by using your favorite **brush tool**, the mouse and the keyboard.

Drawing a Straight Line

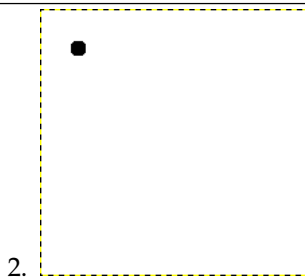
Figure 7.33 A new image



The dialog shows a new image, filled with a white background.

Create a **new image**. Select your favorite **brush tool** or use the **pencil**, if in doubt. Select a **foreground color**, but be sure that the foreground and background colors are different.

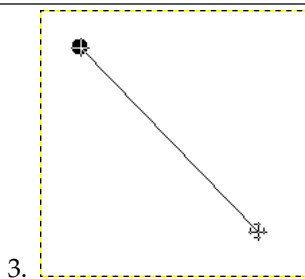
Figure 7.34 The start of the straight line



The dialog shows a new image, with the first dot which indicates the start of the straight line. The dot has a black foreground color.

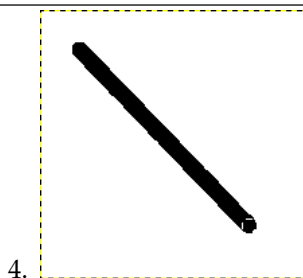
Create a starting point by clicking on the **image display** area with the left mouse button. Your canvas should look similar to Figure 7.33.

Figure 7.35 The helpline



The screenshot shows the helpline, which indicates how the finished line will look.

Now, hold down the **Shift** button on your keyboard and move the mouse away from the starting point you created. You'll see a thin line indicating how the line will look.

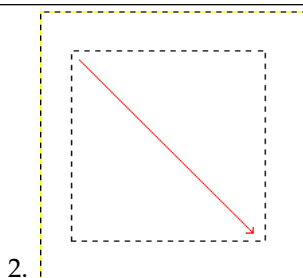
Figure 7.36 The line after the second click

The line created appears in the image window after drawing the second point (or end point), while the **Shift** key is still pressed.

If you're satisfied with the direction and length of the line, click the left mouse button again to finish the line. The GIMP displays a straight line now. If the line doesn't appear, check the foreground and background colors and be sure that you kept the **Shift** key pressed while painting. You can keep creating lines by continuing to hold the **Shift** key and creating additional end points.

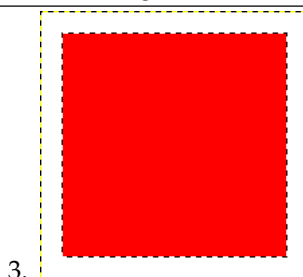
7.14.2 Creating a Basic Shape

1. GIMP is not designed to be used for drawing.³ However, you may create shapes by either painting them using the technique described in Section 7.14.1 or by using the selection tools. Of course, there are various other ways to paint a shape, but we'll stick to the easiest ones here. So, create a **new image** and check that the **foreground and background colors** are different.

Figure 7.37 Creating a rectangular selection

The screenshot shows how a rectangular selection is created. Press and hold the left mouse button while you move the mouse in the direction of the red arrow.

Basic shapes like rectangles or ellipses, can be created using the **selection tools**. This tutorial uses a rectangular selection as an example. So, choose the **rectangular selection tool** and create a new selection: press and hold the left mouse button while you move the mouse to another position in the image (illustrated in figure Figure 7.37). The selection is created when you release the mouse button. For more information about key modifiers see **selection tools**.

Figure 7.38 Rectangular selection filled with foreground color

The screenshot shows a rectangular selection filled with the foreground color.

³Try out e.g. [INKSCAPE] for this purpose.

After creating the selection, you can either create a filled or an outlined shape with the foreground color of your choice. If you go for the first option, choose a **foreground color** and fill the selection with the **bucket fill tool**. If you choose the latter option, create an outline by using the **Stroke selection** menu item from the Edit menu. If you're satisfied with the result, **remove the selection**.

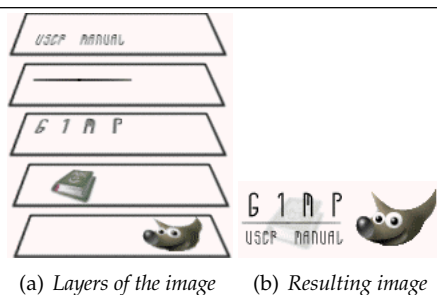
Chapter 8

Combining Images

8.1 Introduction to Layers

You can think of layers as a stack of slides. Using layers, you can construct an image of several conceptual parts, each of which can be manipulated without affecting any other part of the image. Layers are stacked on top of each other. The bottom layer is the background of the image, and the components in the foreground of the image come above it.

Figure 8.1 An image with layers



There is no limit, in principle, to the number of layers an image can have: only the amount of memory available on the system. It is not uncommon for advanced users to work with images containing dozens of layers. You can group layers to make your work easier, and you have many commands to handle layers.

The organization of layers in an image is shown by the Layers dialog, which is the second most important type of dialog window in GIMP, after the Main Toolbox. The appearance of the Layers dialog is shown in the adjoining illustration. How it works is described in detail in the [Layers Dialog](#) section, but we will touch on some aspects of it here, in relation to the layer properties that they display.

Each open image has at any time a single *active drawable*. A “drawable” is a GIMP concept that includes layers, but also several other types of things, such as channels, layer masks, and the selection mask. (Basically, a “drawable” is anything that can be drawn on with painting tools). If a layer is currently active, it is shown highlighted in the Layers dialog, and its name is shown in the status area of the image window. If not, you can activate it by clicking on it. If none of the layers are highlighted, it means the active drawable is something other than a layer.

In the menu bar above an image window, you can find a menu called Layer, containing a number of commands that affect the active layer of the image. The same menu can be accessed by right-clicking in the Layers dialog.

8.1.1 Layer Properties

Each layer in an image has a number of important attributes:

Name Every layer has a name. This is assigned automatically when the layer is created, but you can change it. You can change the name of a layer either by double-clicking on it in the Layers dialog, or by right-clicking there and then selecting the top entry in the menu that appears, Edit Layer Attributes.

Presence or absence of an alpha channel An alpha channel encodes information about how transparent a layer is at each pixel. It is visible in the Channel Dialog: white is complete opacity, black is complete transparency and grey levels are partial transparencies.

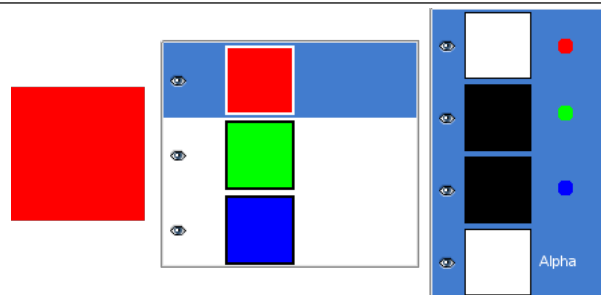
The *background layer* is particular. If you have just created a new image, it has still only one layer which is a background layer. If the image has been created with an opaque Fill type, this one layer has no Alpha channel. To get a background layer with transparency, either you create your new image with a transparent Fill type, or you use the [Add an Alpha Channel](#).

If you add a *new layer*, even with an opaque Fill type, an Alpha channel is automatically added to the layer.

Every layer other than the bottom layer of an image has automatically an Alpha channel, but you can't see a grayscale representation of the alpha values. See [Alpha](#) in Glossary for more information.

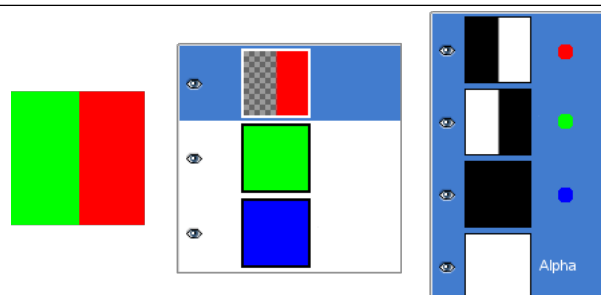
Example for Alpha channel

Figure 8.2 Alpha channel example: Basic image

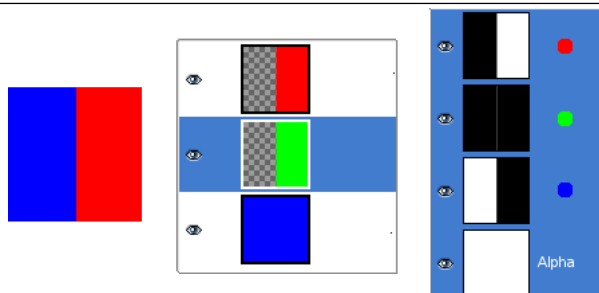


This image has three layers painted with pure 100% opaque Red, Green, and Blue. In the Channel Dialog, you can see that an alpha Channel has been added. It is white because the image is not transparent since there is at least one 100% opaque layer. The current layer is the red one : since it is painted with pure red, there is no green and no blue and the corresponding channels are black.

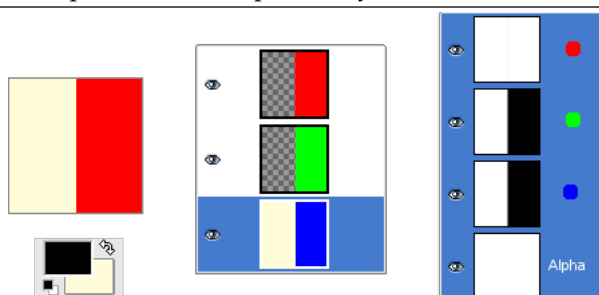
Figure 8.3 Alpha channel example: One transparent layer



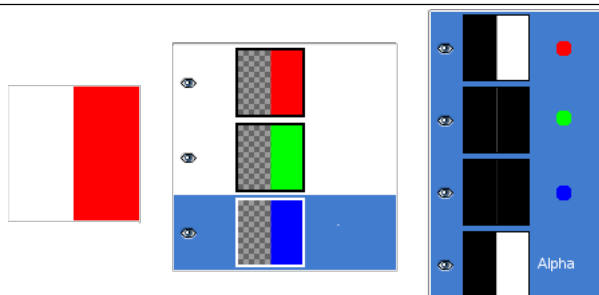
The left part of the first layer has been made transparent (Rectangular selection, Edit/Clear). The second layer, green, is visible. The Alpha channel is still white, since there is an opaque layer in this part of the image.

Figure 8.4 Alpha channel example: Two transparent layers

The left part of the second layer has been made transparent. The third layer, blue, is visible through the first and second layers. The Alpha channel is still white, since there is an opaque layer in this part of the image.

Figure 8.5 Alpha channel example: Three transparent layers

The left part of the third layer has been made transparent. The Alpha channel is still white and the left part of the layer is opaque. The background layer has no Alpha channel. In this case, the Clear command works like the Eraser and uses the Background color of Toolbox.

Figure 8.6 Alpha channel example: Alpha channel added to the Background

We used the Layer → Transparency → Add Alpha Channel command, on the Background layer. Now, the left part of the image is fully transparent and has the color of the page the image is lying on. The left part of the Alpha Channel thumbnail is black (transparent) in the Channel Dialog.

Layer type The layer type is determined by the image type (see previous section) and the presence or absence of an alpha channel. These are the possible layer types:

- RGB
- RGBA
- Gray
- GrayA
- Indexed
- IndexedA

The main reason this matters is that most filters (in the Filters menu) only accept a subset of layer types, and appear grayed out in the menu if the active layer does not have an acceptable type. Often you can rectify this either by changing the mode of the image or by adding or removing an alpha channel.



Visibility It is possible to remove a layer from an image, without destroying it, by clicking on the symbol in the Layers dialog. This is called “toggling the visibility” of the layer. Most operations on an image treat toggled-off layers as if they did not exist. When you work with images containing many layers, with varying opacity, you often can get a better picture of the contents of the layer you want to work on by hiding some of the other layers.

Tip



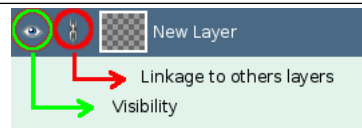
If you *Shift*-click on the eye symbol, this will cause all layers *except* the one you click on to be hidden.

Active layer Usually, you activate a layer, to work on it, clicking it in the layer list. When you have a lot of layers, finding which layer an element of the image belongs to is not easy: then, press **Alt** and click with Mouse wheel on this element to activate its layer. The available layers will be looped through (starting from the upper one) while the **Alt** is held and the picked layer will be temporarily displayed in the status bar.



Linkage to other layers If you click between the eye icon and the layer thumbnail, you get a chain icon, which enables you to group layers for operations on multiple layers (for example with the Move tool or a transform tool).

Figure 8.7 Layer Dialog



Red: Linkage to others layers. Green: Visibility.

Size and boundaries In GIMP, the boundaries of a layer do not necessarily match the boundaries of the image that contains it. When you create text, for example, each text item goes into its own separate layer, and the layer is precisely sized to contain the text and nothing more. Also, when you create a new layer using cut-and-paste, the new layer is sized just large enough to contain the pasted item. In the image window, the boundaries of the currently active layer are shown outlined with a black-and-yellow dashed line.

The main reason why this matters is that you cannot do anything to a layer outside of its boundaries: you can't act on what doesn't exist. If this causes you problems, you can alter the dimensions of the layer using any of several commands that you can find near the bottom of the Layer menu.

Note



The amount of memory that a layer consumes is determined by its dimensions, not its contents. So, if you are working with large images or images that contain many layers, it might pay off to trim layers to the minimum possible size.

Opacity The opacity of a layer determines the extent to which it lets colors from layers beneath it in the stack show through. Opacity ranges from 0 to 100, with 0 meaning complete transparency, and 100 meaning complete opacity.

Mode The Mode of a layer determines how colors from the layer are combined with colors from the underlying layers to produce a visible result. This is a sufficiently complex, and sufficiently important, concept to deserve a section of its own, which follows. See Section 8.2.

Layer mask In addition to the alpha channel, there is another way to control the transparency of a layer: by adding a *layer mask*, which is an extra grayscale drawable associated with the layer. A layer does not have a layer mask by default: it must be added specifically. Layer masks, and how to work with them, are described much more extensively in the [Layer Mask](#) section.

8.2 Layer Modes

GIMP has thirty-eight layer modes, split up in seven types:

- Normal
- Lighten
- Darken
- Contrast
- Inversion
- HSV components
- LCh components

Layer modes are also sometimes called “blending modes”. Selecting a layer mode changes the appearance of the layer or image, based on the layer or layers beneath it. If there is only one layer, the layer mode has no effect. There must therefore be at least two layers in the image to be able to use layer modes.

You can set the layer mode in the Mode menu in the Layers dialog. GIMP uses the layer mode to determine how to combine each pixel in the top layer with the pixel in the same location in the layer below it.

Note



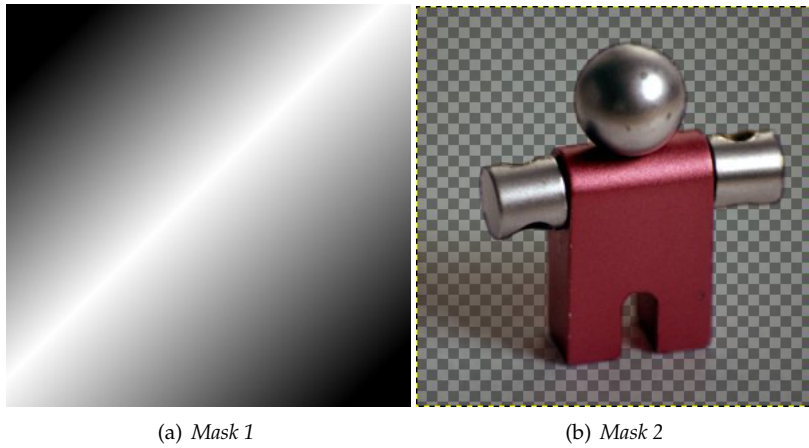
There is a drop-down list in the Toolbox options box which contains modes that affect the painting tools in a similar way to the layer modes. You can use all of the same modes for painting that are available for layers, and there are two additional modes just for the painting tools. See Section 14.3.3.

Layer modes permit complex color changes in the image. They are often used with a new layer which acts as a kind of mask. For example, if you put a solid white layer over an image and set the layer mode of the new layer to “Saturation”, the underlying visible layers will appear in shades of gray.

Note



Prior to blending, images have gamma correction removed and are converted from sRGB to linear. After blending, they are converted back from linear to sRGB. However, before converting back to sRGB, opacity is applied.

Figure 8.8 Images (masks) for layer mode examples

(a) Mask 1

(b) Mask 2

Figure 8.9 Images (backgrounds) for layer mode examples

(a) Key fob

(b) Ducks

In the descriptions of the layer modes below, the equations are also shown. This is for those who are curious about the mathematics of the layer modes. You do not need to understand the equations in order to use the layer modes effectively, however.

The equations are in a shorthand notation. For example, the equation

Equation 8.1 Example

$$E = M + I$$

means, “ For each pixel in the upper (*Mask*) and lower (*Image*) layer, add each of the corresponding color components together to form the *E* resulting pixel’s color. ” Pixel color components must always be between 0 and 255.

Note

Unless the description below says otherwise, a negative color component is set to 0 and a color component larger than 255 is set to 255.

The examples below show the effects of each of the modes.

Since the results of each mode vary greatly depending upon the colors on the layers, these images can only give you a general idea of how the modes work. You are encouraged to try them out yourself. You might start with two similar layers, where one is a copy of the other, but slightly modified (by being blurred, moved, rotated, scaled, color-inverted, etc.) and seeing what happens with the layer modes.

Normal Layer Modes

Normal In this group, only “Normal” is normal. Most other modes are rather *cancellation* modes.

Figure 8.10 Example for layer mode “Normal”



(a) Both images are blended into each other with the same intensity. (b) With 100% opacity only the upper layer is shown when blending with “Normal”.

Normal mode is the default layer mode. The layer on top covers the layers below it. If you want to see anything below the top layer when you use this mode, the layer must have some transparent areas.

The equation is:

Equation 8.2 Equation for layer mode Normal

$$E = M$$

Dissolve

Figure 8.11 Example for layer mode “Dissolve”

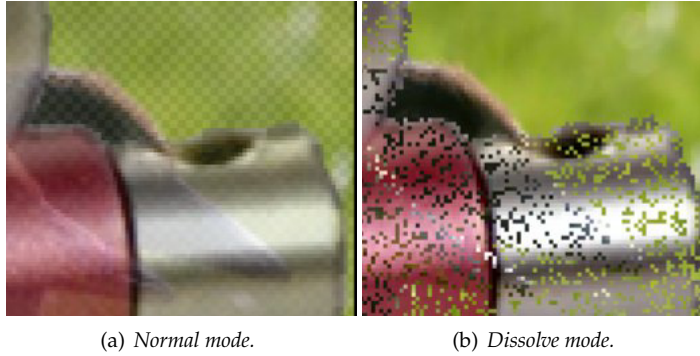


(a) Both images are blended into each other with the same intensity. (b) With 100% opacity only the upper layer is shown when blending with “dissolve”.

Dissolve mode dissolves the upper layer into the layer beneath it by drawing a random pattern of pixels in areas of partial transparency. It is useful as a layer mode, but it is also often useful as a painting mode.

This is especially visible along the edges within an image. It is easiest to see in an enlarged screenshot. The image on the left illustrates “Normal” layer mode (enlarged) and the image on the right shows the same two layers in “Dissolve” mode, where it can be clearly seen how the pixels are dispersed.

Figure 8.12 Enlarged screenshots



Color Erase TODO

Erase TODO

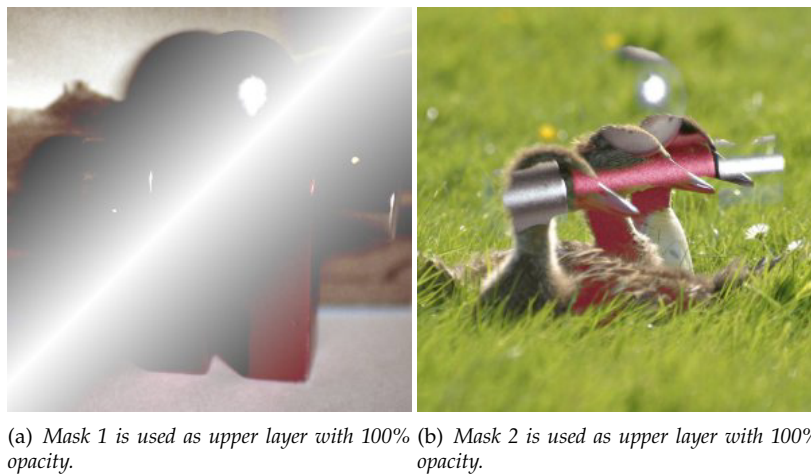
Merge TODO

Erase TODO

Lighten Layer Modes

Lighten only

Figure 8.13 Example for layer mode “Lighten only”



Lighten only mode compares each component of each pixel in the upper layer with the corresponding one in the lower layer and uses the larger value in the resulting image. Completely black layers have no effect on the final image and completely white layers result in a white image.

The equation is:

Equation 8.3 Equation for layer mode Lighten only

$$E = \max(M, I)$$

The mode is commutative; the order of the two layers doesn't matter.

Luma/Luminance lighten only TODO

Screen

Figure 8.14 Example for layer mode "Screen"



(a) Mask 1 is used as upper layer with 100% opacity. (b) Mask 2 is used as upper layer with 100% opacity.

Screen mode inverts the values of each of the visible pixels in the two layers of the image. (That is, it subtracts each of them from 255.) Then it multiplies them together, divides by 255 and inverts this value again. The resulting image is usually brighter, and sometimes "washed out" in appearance. The exceptions to this are a black layer, which does not change the other layer, and a white layer, which results in a white image. Darker colors in the image appear to be more transparent.

The equation is:

Equation 8.4 Equation for layer mode Screen

$$E = 255 - \frac{(255 - M) \times (255 - I)}{255}$$

The mode is commutative; the order of the two layers doesn't matter.

Dodge

Figure 8.15 Example for layer mode "Dodge"



(a) Mask 1 is used as upper layer with 100% opacity. (b) Mask 2 is used as upper layer with 100% opacity.

Dodge mode multiplies the pixel value of the lower layer by 256, then divides that by the inverse of the pixel value of the top layer. The resulting image is usually lighter, but some colors may be inverted.

In photography, dodging is a technique used in a darkroom to decrease the exposure in particular areas of the image. This brings out details in the shadows. When used for this purpose, dodge may work best on Grayscale images and with a painting tool, rather than as a layer mode.

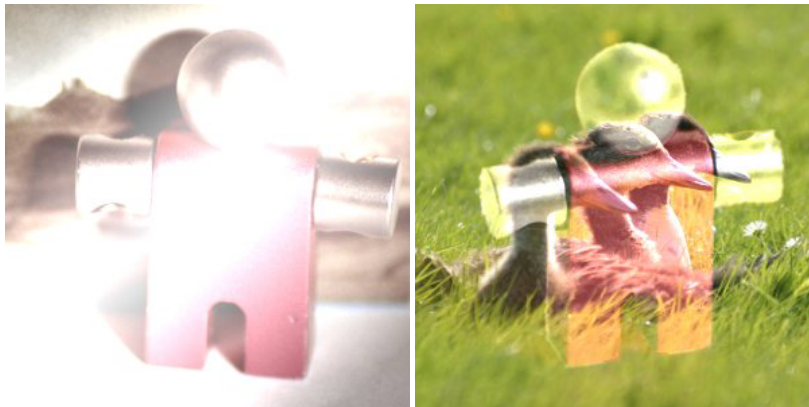
The equation is:

Equation 8.5 Equation for layer mode Dodge

$$E = \frac{256 \times I}{(255 - M) + 1}$$

Addition

Figure 8.16 Example for layer mode “Addition”



(a) Mask 1 is used as upper layer with 100% opacity. (b) Mask 2 is used as upper layer with 100% opacity.

Addition mode is very simple. The pixel values of the upper and lower layers are added to each other. The resulting image is usually lighter. The equation can result in color values greater than 255, so some of the light colors may be set to the maximum value of 255.

The equation is:

Equation 8.6 Equation for layer mode Addition

$$E = \min((M + I), 255)$$

The mode is commutative; the order of the two layers doesn't matter.

Darken Layer Modes

Darken only

Figure 8.17 Example for layer mode “Darken only”

(a) Mask 1 is used as upper layer with 100% opacity. (b) Mask 2 is used as upper layer with 100% opacity.

Darken only mode compares each component of each pixel in the upper layer with the corresponding one in the lower layer and uses the smaller value in the resulting image. Completely white layers have no effect on the final image and completely black layers result in a black image.

The equation is:

Equation 8.7 Equation for layer mode Darken only

$$E = \min(M, I)$$

The mode is commutative; the order of the two layers doesn't matter.

Luma/Luminance darken only TODO

Multiply

Figure 8.18 Example for layer mode “Multiply”

(a) Mask 1 is used as upper layer with 100% opacity. (b) Mask 2 is used as upper layer with 100% opacity.

Multiply mode multiplies the pixel values of the upper layer with those of the layer below it and then divides the result by 255. The result is usually a darker image. If either layer is white, the resulting image is the same as the other layer ($1 * I = I$). If either layer is black, the resulting image is completely black ($0 * I = 0$).

The equation is:

Equation 8.8 Equation for layer mode Multiply

$$E = \frac{M \times I}{255}$$

The mode is commutative; the order of the two layers doesn't matter.

Burn

Figure 8.19 Example for layer mode "Burn"



(a) Mask 1 is used as upper layer with 100% opacity. (b) Mask 2 is used as upper layer with 100% opacity.

Burn mode inverts the pixel value of the lower layer, multiplies it by 256, divides that by one plus the pixel value of the upper layer, then inverts the result. It tends to make the image darker, somewhat similar to "Multiply" mode.

In photography, burning is a technique used in a darkroom to increase the exposure in particular areas of the image. This brings out details in the highlights. When used for this purpose, burn may work best on Grayscale images and with a painting tool, rather than as a layer mode.

The equation is:

Equation 8.9 Equation for layer mode Burn

$$E = 255 - \frac{256 \times (255 - I)}{M + 1}$$

Linear burn TODO

Contrast Layer Modes

Overlay

Figure 8.20 Example for layer mode “Overlay”

(a) Mask 1 is used as upper layer with 100% opacity.
 (b) Mask 2 is used as upper layer with 100% opacity.

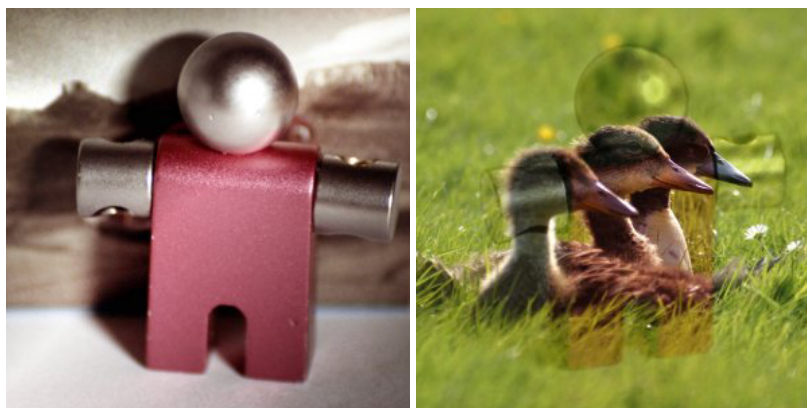
Overlay mode inverts the pixel value of the lower layer, multiplies it by two times the pixel value of the upper layer, adds that to the original pixel value of the lower layer, divides by 255, and then multiplies by the pixel value of the original lower layer and divides by 255 again. It darkens the image, but not as much as with “Multiply” mode.

The equation is: ¹

Equation 8.10 Equation for layer mode Overlay

$$E = \frac{I}{255} \times \left(I + \frac{2 \times M}{255} \times (255 - I) \right)$$

Soft light

Figure 8.21 Example for layer mode “Soft light”

(a) Mask 1 is used as upper layer with 100% opacity.
 (b) Mask 2 is used as upper layer with 100% opacity.

Soft light is not related to “Hard light” in anything but the name, but it does tend to make the edges softer and the colors not so bright. It is similar to “Overlay” mode. In some versions of GIMP, “Overlay” mode and “Soft light” mode are identical.

The equation is complicated. It needs Rs, the result of Screen mode :

¹ The equation is the *theoretical* equation. Due to [Bug #162395](#), the actual equation is equivalent to Soft light. It is difficult to fix this bug without changing the appearance of existing images.

Equation 8.11 Equation for layer mode Screen

$$R_s = 255 - \frac{(255 - M) \times (255 - I)}{255}$$

Equation 8.12 Equation for layer mode Soft light

$$E = \frac{(255 - I) \times M + R_s}{255} \times I$$

Hard light

Figure 8.22 Example for layer mode “Hard light”



(a) Mask 1 is used as upper layer with 100% opacity.

(b) Mask 2 is used as upper layer with 100% opacity.

Hard light mode is rather complicated because the equation consists of two parts, one for darker colors and one for brighter colors. If the pixel color of the upper layer is greater than 128, the layers are combined according to the first formula shown below. Otherwise, the pixel values of the upper and lower layers are multiplied together and multiplied by two, then divided by 256. You might use this mode to combine two photographs and obtain bright colors and sharp edges.

The equation is complex and different according to the value >128 or <128 :

Equation 8.13 Equation for layer mode Hard light, $M > 128$

$$E = 255 - \frac{(255 - 2 \times (M - 128)) \times (255 - I)}{256}, \quad M > 128$$

Equation 8.14 Equation for layer mode Hard light, $M < 128$

$$E = \frac{2 \times M \times I}{256}, \quad M \leq 128$$

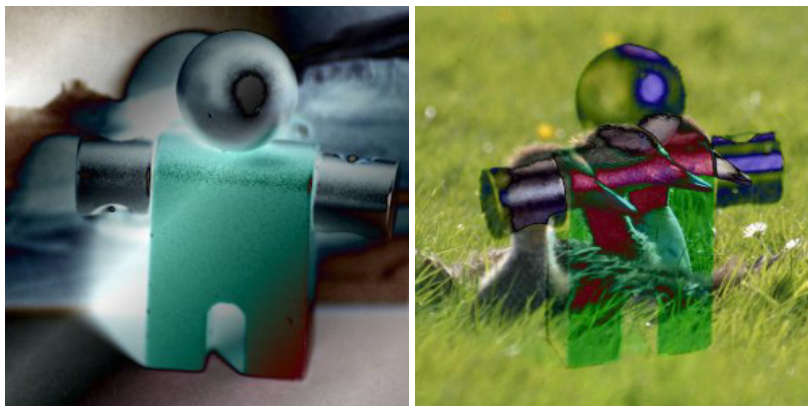
Vivid light TODO

Pin light TODO

Linear light TODO

Hard mix TODO

Inversion Layer Modes

Difference**Figure 8.23** Example for layer mode “Difference”

(a) Mask 1 is used as upper layer with 100% opacity. (b) Mask 2 is used as upper layer with 100% opacity.

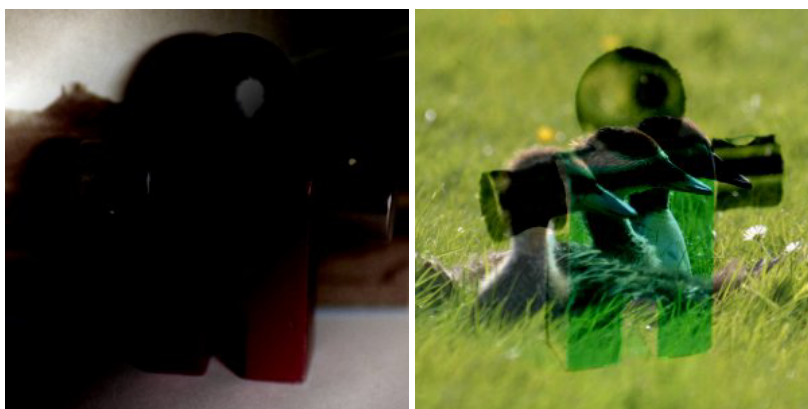
Difference mode subtracts the pixel value of the upper layer from that of the lower layer and then takes the absolute value of the result. No matter what the original two layers look like, the result looks rather odd. You can use it to invert elements of an image.

The equation is:

Equation 8.15 Equation for layer mode Difference

$$E = |I - M|$$

The mode is commutative; the order of the two layers doesn't matter.

Exclusion TODO**Subtract****Figure 8.24** Example for layer mode “Subtract”

(a) Mask 1 is used as upper layer with 100% opacity. (b) Mask 2 is used as upper layer with 100% opacity.

Subtract mode subtracts the pixel values of the upper layer from the pixel values of the lower layer. The resulting image is normally darker. You might get a lot of black or near-black in the resulting

image. The equation can result in negative color values, so some of the dark colors may be set to the minimum value of 0.

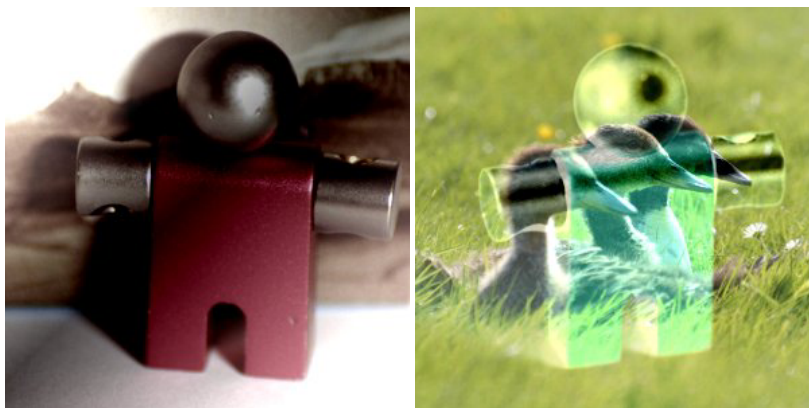
The equation is:

Equation 8.16 Equation for layer mode Subtraction

$$E = \max((I - M), 0)$$

Grain extract

Figure 8.25 Example for layer mode “Grain extract”



(a) Mask 1 is used as upper layer with 100% opacity. (b) Mask 2 is used as upper layer with 100% opacity.

Grain extract mode is supposed to extract the “film grain” from a layer to produce a new layer that is pure grain, but it can also be useful for giving images an embossed appearance. It subtracts the pixel value of the upper layer from that of the lower layer and adds 128.

The equation is:

Equation 8.17 Equation for layer mode Grain extract

$$E = I - M + 128$$

Grain merge There are two more layer modes, but these are available only for painting tools. See [Painting Modes](#) for detailed information.

Figure 8.26 Example for layer mode “Grain merge”

(a) Mask 1 is used as upper layer with 100% opacity.
 (b) Mask 2 is used as upper layer with 100% opacity.

Grain merge mode merges a grain layer (possibly one created from the “Grain extract” mode) into the current layer, leaving a grainy version of the original layer. It does just the opposite of “Grain extract”. It adds the pixel values of the upper and lower layers together and subtracts 128.

The equation is:

Equation 8.18 Equation for layer mode Grain merge

$$E = I + M - 128$$

Divide

Figure 8.27 Example for layer mode “Divide”

(a) Mask 1 is used as upper layer with 100% opacity.
 (b) Mask 2 is used as upper layer with 100% opacity.

Divide mode multiplies each pixel value in the lower layer by 256 and then divides that by the corresponding pixel value of the upper layer plus one. (Adding one to the denominator avoids dividing by zero.) The resulting image is often lighter, and sometimes looks “burned out”.

The equation is:

Equation 8.19 Equation for layer mode Divide

$$E = \frac{256 \times I}{M + 1}$$

HSV Components Layer Modes

HSV Hue TODO

HSV Saturation TODO

HSL Color TODO

HSV Value TODO

LCh Components Layer Modes

LCh Hue TODO

LCh Chroma TODO

LCh Color TODO

LCh Lightness TODO

Luminance TODO

Each layer in an image can have a different layer mode. (Of course, the layer mode of the bottom layer of an image has no effect.) The effects of these layer modes are cumulative. The image shown below has three layers. The top layer consists of Wilber surrounded by transparency and has a layer mode of “Difference”. The second layer is solid light blue and has a layer mode of “Addition”. The bottom layer is filled with the “Red Cubes” pattern.

Figure 8.28 Multi layer example



GIMP also has similar modes which are used for the painting tools. These are the same twenty-one modes as the layer modes, plus additionally two modes which are specific to the painting tools. You can set these modes from the Mode menu in the Tools option dialog. In the equations shown above, the layer you are painting on is the “lower layer” and the pixels painted by the tool are the “upper layer”. Naturally, you do not need more than one layer in the image to use these modes, since they only operate on the current layer and the selected painting tool.

See Section [14.3.1.3](#) for a description of the two additional painting modes.

8.3 Creating New Layers

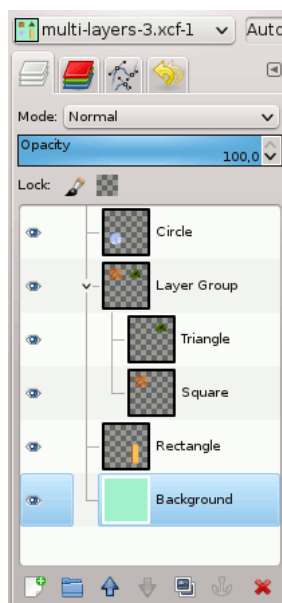
There are several ways to create new layers in an image. Here are the most important ones:

- Selecting Layer → New Layer in the image menu. This brings up a dialog that allows you to set the basic properties of the new layer; see the [New Layer dialog](#) section for help with it.
- Selecting Layer → Duplicate Layer in the image menu. This creates a new layer, that is a perfect copy of the currently active layer, just above the active layer.
- When you “cut” or “copy” something, and then paste it using Ctrl-V or Edit → Paste, the result is a “floating selection”, which is a sort of temporary layer. Before you can do anything else, you either have to anchor the floating selection to an existing layer, or convert it into a normal layer. If you do the latter, the new layer will be sized just large enough to contain the pasted material.

8.4 Layer Groups

Layer Groups are available in GIMP 2.8 and newer.

You can group layers that have similarities in a tree-like way. So, the layer list becomes easier to manage.



Create a Layer Group You can create a layer group by clicking the New Layer Group button at the bottom of the layers dialog,

through Layer → New Layer Group, or through the Layers dialog context menu.

This empty layer group appears just above the current layer. It is recommended to give it a name that is descriptive. To change the layer group name, double-click the name, or press **F2** the name, or right-click it and then select the **Edit Layer Attributes** in the context menu. If you don't rename your layer groups, you will get confused when several are created with names such as Layer Group #1, Layer Group #2, etc.

You can create several layer groups and you can **embed** them, that is include a layer group in another one.

Adding Layers to a Layer Group You can add *existing layers* to a layer group by click-and-dragging them.

Note

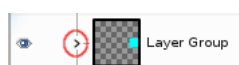


The hand representing the mouse pointer must turn smaller before releasing the mouse button.

A thin horizontal line marks where the layer will be laid down.

To add a *new layer* to the current layer group, click the New Layer... at the bottom of the Layers dialog, or use the New Layer command in the image menu or press Shift-Ctrl-N.

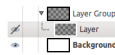
When a layer group is not empty, a small ">" icon appears. By clicking it, you can fold or unfold the layer list.



Layers that belong to a layer group are slightly indented to the right, allowing you know easily which layers are part of the group.

Visibility If a layer group is made invisible using the eye icon but still open (so that the layers inside the group are shown in the list), there is a struck out eye shown besides the layers that are inside

the group to indicate that these layers are not displayed in the final projection of the image, but theoretically visible in the layer group.



Raise and Lower Layer Groups You can raise and lower layer groups in the Layer dialog as you do with normal layers: click-and-dragging, and by using **up arrow** and **down arrow** keys at the bottom of the Layer dialog.

Duplicate a Layer Group To duplicate a layer group, click the Create a duplicate of the layer button or right-click and select the **Duplicate Layer** command in the pop up context menu.

Move Layer Groups You can **move a layer group to another image** by click-and-dragging. You can also copy-paste it using Ctrl-C and Ctrl-V: then, you get a floating selection that you must anchor (anchor button at the bottom of the Layer dialog).

You can also **move a layer group to the canvas**: this duplicates the group *in* the group. Chain all layers in the duplicated layer group, select the Move tool, then, in the image, move the layer. That's one way to multiply multi-layer objects in an image.

Delete a Layer Group To delete a layer group, click the red cross button at the bottom of the Layer dialog or right-click and select **Delete layer**.

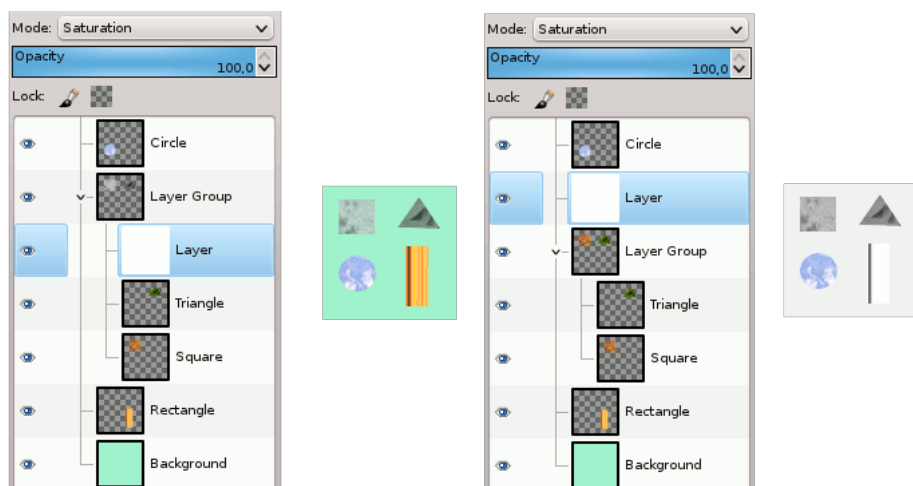
Embed Layer Groups When a layer group is activated, you can add another group inside it with the "Add New Layer Group" command. There seems to be no limit, excepted memory, to the number of embedded layer groups.

Layer Modes and Groups A layer mode applied to a layer group acts on layers that are in this group only. A layer mode above a layer group acts on all layers underneath, outside and inside the layer groups.



Original image

Figure 8.29 Layer Mode in or out Layer Group



(a) We added a white layer in the layer group with saturation mode: only square and triangle are disabled. (b) We added a white layer out of the layer group with saturation mode: all layers underneath are disabled, including the background layer.

With GIMP 2.10 and newer, layer groups have a special layer mode: the Pass Through mode. This mode exists only if a layer group is active.

When this mode is used instead of any other one, layers inside the layer group will behave as if they were a part of the layer stack, not belonging to the group. Layers within the group blend with layers below, inside and outside the group.

While with Normal mode, layers within a group are treated as if they were a single layer, which is then blended with other layers below in the stack; a modifier on a layer inside the group blends layers below in the group only.

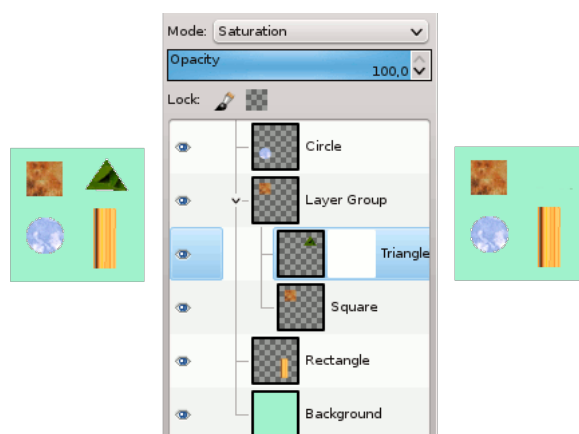
More details about Pass Through in *Pass-through*.

Opacity When a layer group is activated, opacity changes are applied to all the layers of the group.

Layer Mask With GIMP 2.10 and newer, masks on layer groups are possible. They work similarly to ordinary-layer masks, with the following considerations.

The group's mask size is the same as group's size (i.e., the bounding box of its children) at all times. When the group's size changes, the mask is cropped to the new size — areas of the mask that fall outside of the new bounds are discarded, and newly added areas are filled with black (and hence are transparent by default).

Of course, you still can add a layer mask to a layer in the group to mask a part of the layer:



We added a white (Full opacity) layer mask to the triangle layer.

Finding a layer When working with a lot of layers, finding a particular layer in the list may be difficult. With GIMP 2.10.10 and newer, a new *on-canvas layer selection* function is available. Alt-middle click the image element you want to find the layer this element belongs to: the available layers will be looped through to show the new active layer and the layer name will be temporarily displayed in the status bar.

Layer preview There were problems with drawable preview rendering in the case of a large image consisting of many layers. This problem is fixed with GIMP 2.10.10 and newer, except for layer groups. You can disable rendering layer group previews in Edit → Preferences → Interface.

Chapter 9

Text Management

9.1 Text Management

Text is managed with the Text tool. This tool creates a new layer containing the text, above the current layer in the layer dialog, with the size of the text box. Its name is the beginning of the text.

Figure 9.1 Example of a text item



(a) Example of a text item, (b) The layer dialog, with the showing the boundary of the text layer above the layer which text layer. (Font: Utopia was current. Bold)

The Text tool is progressively improved. With GIMP-2.8, you can now edit text directly on canvas. A text tool box has been added which overlays the canvas above the text box.



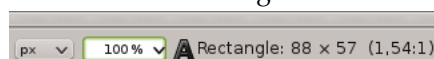
As soon as you click on the canvas with the Text tool, you get a closed text box and a semi-transparent tool box just above.

Text tool options are described in Section 14.5.6.

9.1.1 Text Area

You can start typing text at once. The text box will enlarge gradually. Press **Enter** to add a new line.

You can also **enlarge the text box** by click-and-dragging, as you do with selections. The box size appears then in the status bar at the bottom of the image:

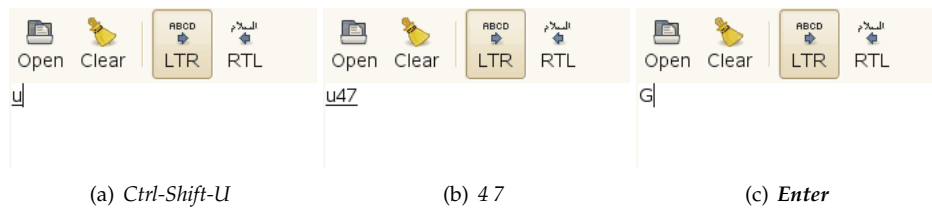


To **edit text**, you must, first, select the part you want to edit by click-and-drag, or Shift-arrow keys and then use the options of the Section 9.1.3.

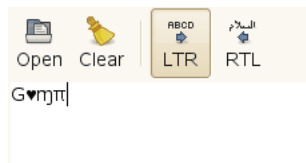
Instead of using the on-canvas text editing, you can use the text editor dialog described in Section 14.5.6.3.

You can **move the text** on the image using the Move tool: you must click on a character, not on the background.

You can get Unicode characters with Ctrl-Shift-U plus hexadecimal Unicode code of the desired char, for example:

Figure 9.2 Entering Unicode characters

Of course this feature is more useful for entering special (even exotic) characters, provided that the required glyphs for these characters are supplied by the selected font — only few fonts support Klingon. ;-)



Unicode 0x47 (“G”), 0x2665, 0x0271, 0x03C0

You can **edit the text later**, if the text layer still exists and has not been modified by another tool (see below): make the text layer active in the **Layer dialog**, select the Text tool and click on the text in the image window.

9.1.2 Managing Text Layer

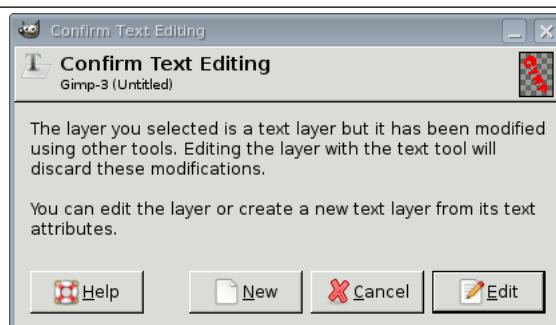
You can operate on a text layer in the same ways as any other layer, but doing so often means giving up the ability to edit the text without losing the results of your work.

To understand some of the idiosyncrasies of text handling, it may help for you to realize that a text layer contains more information than the pixel data that you see: it also contains a representation of the text in a text-editor format. You can see this in the text-editor window that pops up while you are using the Text tool. Every time you alter the text, the image layer is redrawn to reflect your changes.

Now suppose you create a text layer, and then operate on it in some way that does not involve the Text tool: rotate it, for example. Suppose you then come back and try to edit it using the Text tool. As soon as you edit the text, the Text tool will redraw the layer, wiping out the results of the operations you performed in the meantime.

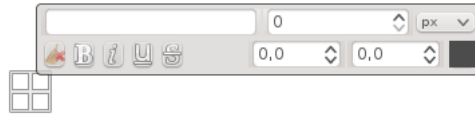
Because this danger is not obvious, the Text tool tries to protect you from it. If you operate on a text layer, and then later try to edit the text, a message pops up, warning you that your alterations will be undone, and giving you three options:

- edit the text anyway;
- cancel;
- create a new text layer with the same text as the existing layer, leaving the existing layer unchanged.

Figure 9.3 Warning lose modifications

9.1.3 Text Toolbox

Figure 9.4 Text Toolbox

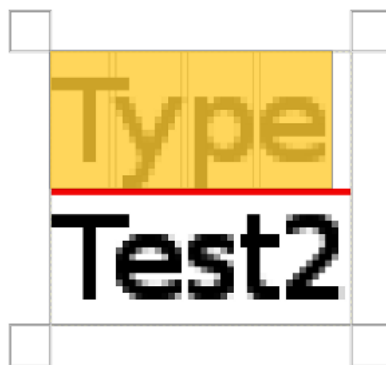


You get this box, which overlays canvas, as soon as you click on canvas with the Text Tool. It allows you to edit text directly on canvas.

Apart from the usual text formatting features like font family, style and size selectors you get numeric control over baseline offset and kerning, as well as the ability to change text color for a selection.

- **Change font of selected text:** as soon as you start editing the default font name, a drop-down list appears, allowing you to select a font.
- **Change size of selected text:** self-explanatory.
- **Bold, Italic, Underline, Strikethrough :** self-explanatory.
- **Change baseline of selected text:** "In European typography and penmanship, baseline is the line upon which most letters "sit" and below which descenders extend" (Wikipedia). In HTML, there are several kinds of baselines (alphabetic, ideographic, bottom...). Here, consider that baseline is "bottom" and determines the place for descenders. The default baseline "0" gives place for descenders. You can use it to increase space between two lines only, while "Adjust line spacing" in tool options increases space between all lines.

Figure 9.5 Default Baseline



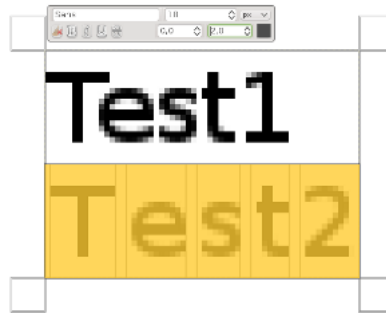
Default baseline marked with a red line.

- **Change kerning of selected text:** "In typography, kerning... is the process of adjusting the spacing between characters in a proportional font." (Wikipedia). You will probably use this setting to adjust letter spacing of a selected part of text.

Let us look at a selected text (zoomx800 to see pixels):

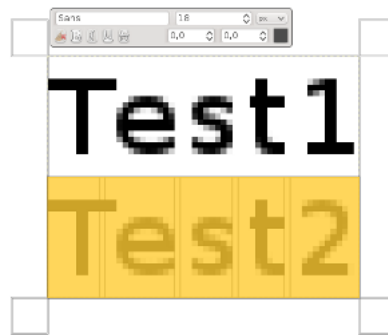


We can see that the Sans font is a proportional font: letters widths are different, and “T” glyph comes over the “e”. Letters widths are marked with thin vertical lines and left borders of letter width cover preceding letters by one pixel. Now we set “Change kerning of selected text” to 2 pixels:



Blank spaces, 2 pixels wide, are added between all selected characters and letter widths are preserved. If no text is selected, a blank space is added at the place of the mouse pointer between two characters.

Now, we compare with the “Adjust letter spacing” option of Text tool:

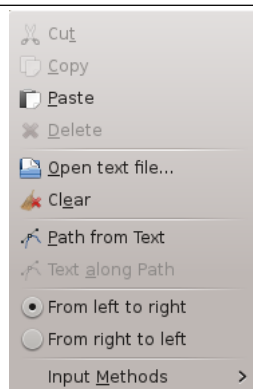


The option applies to the whole text, not only to the selected text. Blank spaces are added inside letters widths and letter widths are not respected.

- You can also use Alt-arrow keys to change baseline offset and kerning.
- **Change color of selected text:** this command opens a color dialog where you choose a color for the selected text.
- **Clear style of selected text:** using this command, you can get rid of all new settings you applied to the selected text.

9.1.4 Text Context Menu

Figure 9.6 Text Editing Context Menu



You get this menu by right-clicking on text. It is somewhat different from that of the Text Editor dialog.

- Cut, Copy, Paste, Delete: these options concern a selected text. They remain grayed out as long as no text is selected. “Paste” is activated if the clipboard is full of text.
- Open text file: this command opens a file browser where you can find the wanted text file.
- Clear: this command deletes all the text, selected or not.
- Path from text: this command creates a path from the outlines of the current text. The result is not evident. You have to open the Path dialog and make path visible. Then select the Path tool and click on the text. Every letter is now surrounded with a path component. So you can modify the shape of letters by moving path control points.

This command is similar to Layer → Text to Path.

Figure 9.7 Text to path applied



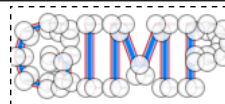
Nothing appears.

Figure 9.8 Path made visible



Path made visible in Path tab. Path appears as a red border around text.

Figure 9.9 Path tool activated



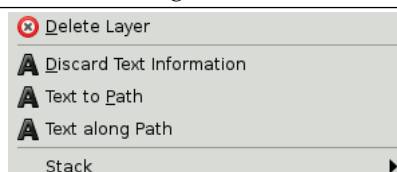
Path tool activated; click on path.

- Text along path:

This option is enabled only if a **path** exists. When your text is created, then create or import a path and make it active. If you create your path before the text, the path becomes invisible and you have to make it visible in the Path Dialog.

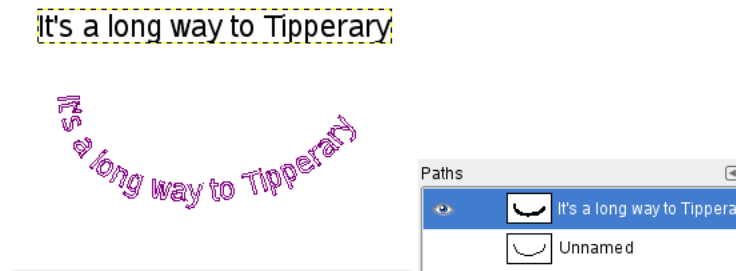
This command is also available from the “Layer” menu:

Figure 9.10 The Text along Path command among text commands in the Layer menu



This group of options appears only if a text layer exists.

Click on the Text along Path button. The text is bent along the path. Letters are represented with their outline. Each of them is a component of the new path that appears in the **Path dialog**. All path options should apply to this new path.

Figure 9.11 “Text along Path” example

- From Left to Right / From Right to Left: fix the writing direction of your language.
- Input Methods: methods are available for some languages. For example, selecting “Inuktitut” transforms your keyboard into an Inuktitut keyboard, temporarily.

9.2 Text

9.2.1 Embellishing Text

Figure 9.12 Fancy text

Four fancy text items created using logo scripts: “alien neon”, “bovination”, “frosty”, and “chalk”. Default settings were used for everything except font size.

There are many things you can do to vary the appearance of text beyond just rendering it with different fonts or different colors. By converting a text item to a selection or a path, you can fill it, stroke the outlines, transform it, or generally apply the whole panoply of GIMP tools to get interesting effects. As a demonstration of some of the possibilities, try out the “logo” scripts at File → Create → Logos.

Note



This Logos item no longer exists in GIMP-2.10.10. But many scripts are still available in <https://download.gimp.org/mirror/pub/gimp/extras>.

Each of these scripts allows you to enter some text, and then creates a new image showing a logo constructed out of that text. If you would like to modify one of these scripts, or construct a logo script of your own, the [Using Script-Fu](#) and [Script-Fu Tutorial](#) sections should help you get started. Of course, you don’t need Script-Fu to create these sorts of effects, only to automate them.

9.2.2 Adding Fonts


For the most authoritative and up-to-date information on fonts in GIMP, consult the “Fonts in GIMP 2.0” page [[GIMP-FONTS](#)] at the GIMP web site. This section attempts to give you a helpful overview.

GIMP uses the FreeType 2 font engine to render fonts, and a system called Fontconfig to manage them. GIMP will let you use any font in Fontconfig's font path; it will also let you use any font it finds in GIMP's font search path, which is set on the **Font Folders** page of the Preferences dialog. By default, the font search path includes a system GIMP-fonts folder (which you should not alter, even though it is actually empty), and a `fonts` folder inside your personal GIMP directory. You can add new folders to the font search path if it is more convenient for you.

FreeType 2 is a very powerful and flexible system. By default, it supports the following font file formats:

- TrueType fonts (and collections)
- Type 1 fonts
- CID-keyed Type 1 fonts
- CFF fonts
- OpenType fonts (both TrueType and CFF variants)
- SFNT-based bitmap fonts
- X11 PCF fonts
- Windows FNT fonts
- BDF fonts (including anti-aliased ones)
- PFR fonts
- Type42 fonts (limited support)

You can also add modules to support other types of font files. See FREETYPE 2 [FREETYPE] for more information.

Linux On a Linux system, if the Fontconfig utility is set up as usual, all you need to do to add a new font is to place the file in the directory `~/ .fonts`. This will make the font available not only to GIMP, but to any other program that uses Fontconfig. If for some reason you want the font to be available to GIMP only, you can place it in the `fonts` sub-directory of your personal GIMP directory, or some other location in your font search path. Doing either will cause the font to show up the next time you start GIMP. If you want to use it in an already running GIMP, press the *Refresh*  button in the **Fonts dialog**.

Windows The easiest way to install a font is to drag the file onto the Fonts directory and let the shell do its magic. Unless you've done something creative, it's probably in its default location of `C:\windows\fonts` or `C:\winnt\fonts`. Sometimes double-clicking on a font will install it as well as display it; sometimes it only displays it. This method will make the font available not only to GIMP, but also to other Windows applications.

Mac OS X There are several ways to install fonts on your system. You can drag-and-drop them to the "Fonts" folder in "Libraries" folder of your "Home Folder". Or you may use Font Book, invoked by double-clicking the font file icon in the Finder. You can see what the font looks like, and click your favorite fonts so that their files are to be installed on the system. These methods will make the fonts available for all applications, not only GIMP. If you want all users can use the fonts, drag-and-drop the fonts to the "Fonts" folder in "Libraries" folder of the Mac OS X Disk, or to the "Computer" folder in the Collection column of Font Book.

To install a Type 1 file, you need both the `.pfb` and `.pfm` files. Drag the one that gets an icon into the fonts folder. The other one doesn't strictly need to be in the same directory when you drag the file, since it uses some kind of search algorithm to find it if it's not, but in any case putting it in the same directory does no harm.

In principle, GIMP can use any type of font on Windows that FreeType can handle; however, for fonts that Windows can't handle natively, you should install them by placing the font files in the `fonts` folder of your personal GIMP directory, or some other location in your font search path. The support Windows has varies by version. All that GIMP runs on support at least TrueType, Windows FON, and Windows FNT. Windows 2000 and later support Type 1 and OpenType. Windows ME supports OpenType and possibly Type 1 (but the most widely used Windows GIMP installer does not officially support Windows ME, although it may work anyway).

Note

GIMP uses Fontconfig to manage fonts on Windows as well as Linux. The instructions above work because Fontconfig by default uses the Windows fonts directory, i. e., the same fonts that Windows uses itself. If for some reason your Fontconfig is set up differently, you will have to figure out where to put fonts so that GIMP can find them: in any case, the `fonts` folder of your personal GIMP directory should work.

9.2.3 Font Problems

Problems with fonts have probably been responsible for more GIMP 2 bug reports than any other single cause, although they have become much less frequent in the most recent releases in the 2.0 series. In most cases they have been caused by malformed font files giving trouble to Fontconfig. If you experience crashes at start-up when GIMP scans your font directories, the best solution is to upgrade to a version of Fontconfig newer than 2.2.0. As a quick workaround you can start gimp with the `--no-fonts` command-line option, but then you will not be able to use the text tool.

Another known problem is that Pango 1.2 cannot load fonts that don't provide an Unicode character mapping. (Pango is the text layout library used by GIMP.) A lot of symbol fonts fall into this category. On some systems, using such a font can cause GIMP to crash. Updating to Pango 1.4 will fix this problem and makes symbol fonts available in GIMP.

A frequent source of confusion occurs on Windows systems, when GIMP encounters a malformed font file and generates an error message: this causes a console window to pop up so that you can see the message. *Do not close that console window. It is harmless, and closing it will shut down GIMP.* When this happens, it often seems to users that GIMP has crashed. It hasn't: closing the console window causes Windows to shut GIMP down. Unfortunately, this annoying situation is caused by an interaction between Windows and the libraries that GIMP links to: it cannot be fixed within GIMP. All you need to do, though, if this happens, is minimize the console window and ignore it.

Chapter 10

Enhancing Photographs

10.1 Working with Digital Camera Photos

10.1.1 Introduction


One of the most common uses of GIMP is to fix digital camera images that for some reason are less than perfect. Maybe the image is overexposed or underexposed; maybe rotated a bit; maybe out of focus: these are all common problems for which GIMP has good tools. The purpose of this chapter is to give you an overview of those tools and the situations in which they are useful. You will not find detailed tutorials here: in most cases it is easier to learn how to use the tools by experimenting with them than by reading about them. (Also, each tool is described more thoroughly in the Help section devoted to it.) You will also not find anything in this chapter about the multitude of “special effects” that you can apply to an image using GIMP. You should be familiar with basic GIMP concepts before reading this chapter, but you certainly don’t need to be an expert—if you are, you probably know most of this anyway. And don’t hesitate to experiment: GIMP’s powerful “undo” system allows you to recover from almost any mistake with a simple Ctrl-Z.

Most commonly the things that you want to do to clean up an imperfect photo are of four types: improving the composition; improving the colors; improving the sharpness; and removing artifacts or other undesirable elements of the image.

10.1.2 Improving Composition

10.1.2.1 Rotating an Image

It is easy, when taking a picture, to hold the camera not quite perfectly vertical, resulting in a picture where things are tilted at an angle. In GIMP, the way to fix this is to use the **Rotate** tool. Activate this

by clicking its icon  in the Toolbox, or by pressing the Shift-R while inside the image. Make sure the Tool Options are visible, and at the top, make sure for “Transform:” that the left button (“Transform Layer”) is selected. If you then click the mouse inside the image and drag it, you will see a grid appear that rotates as you drag. When the grid looks right, click Rotate or press **Enter**, and the image will be rotated.

Now as a matter of fact, it isn’t so easy to get things right by this method: you often find that things are better but not quite perfect. One solution is to rotate a bit more, but there is a disadvantage to that approach. Each time you rotate an image, because the rotated pixels don’t line up precisely with the original pixels, the image inevitably gets blurred a little bit. For a single rotation, the amount of blurring is quite small, but two rotations cause twice as much blurring as one, and there is no reason to blur things more than you have to. A better alternative is to undo the rotation and then do another, adjusting the angle.

Fortunately, GIMP provides another way of doing it that is considerably easier to use: in the Rotate Tool Options, for the Transform Direction you can select “Backward (Corrective)”. When you do this, instead of rotating the grid to compensate for the error, you can rotate it to *line up* with the error. If this seems confusing, try it and you will see that it is quite straightforward.

Note



Since GIMP 2.2, there is an option to preview the results of transformations, instead of just seeing a grid. This makes it easier to get things right on the first try.

After you have rotated an image, there will be unpleasant triangular “holes” at the corners. One way to fix them is to create a background that fills the holes with some unobtrusive or neutral color, but usually a better solution is to crop the image. The greater the rotation, the more cropping is required, so it is best to get the camera aligned as well as possible when you take the picture in the first place.

10.1.2.2 Cropping

When you take a picture with a digital camera, you have some control over what gets included in the image but often not as much as you would like: the result is images that could benefit from trimming. Beyond this, it is often possible to enhance the impact of an image by trimming it so that the most important elements are placed at key points. A rule of thumb, not always to be followed but good to keep in mind, is the “rule of thirds”, which says that maximum impact is obtained by placing the center of interest one-third of the way across the image, both widthwise and heightwise.

To crop an image, activate the **Crop** tool in the Toolbox, or by pressing the “C” key (capitalized) while inside the image. With the tool active, clicking and dragging in the image will sweep out a crop rectangle. It will also pop up a dialog that allows you to adjust the dimensions of the crop region if they aren’t quite right. When everything is perfect, hit the Crop button in the dialog.

10.1.3 Improving Colors

10.1.3.1 Automated Tools

In spite of sophisticated exposure-control systems, pictures taken with digital cameras often come out over- or under-exposed, or with color casts due to imperfections in lighting. GIMP gives you a variety of tools to correct colors in an image, ranging to automated tools that run with a simple button-click to highly sophisticated tools that give you many parameters of control. We will start with the simplest first.

GIMP gives you several automated color correction tools. Unfortunately they don’t usually give you quite the results you are looking for, but they only take a moment to try out, and if nothing else they often give you an idea of some of the possibilities inherent in the image. Except for “Auto Levels”, you can find these tools by following the menu path Colors → Auto in the image menu.

Here they are, with a few words about each:

Normalize This tool (it is really a plug-in) is useful for underexposed images: it adjusts the whole image uniformly until the brightest point is right at the saturation limit, and the darkest point is black. The downside is that the amount of brightening is determined entirely by the lightest and darkest points in the image, so even one single white pixel and/or one single black pixel will make normalization ineffective.

Equalize This is a very powerful adjustment that tries to spread the colors in the image evenly across the range of possible intensities. In some cases the effect is amazing, bringing out contrasts that are very difficult to get in any other way; but more commonly, it just makes the image look weird. Oh well, it only takes a moment to try.

Color Enhance This command increases the saturation range of the colors in the layer, without altering brightness or hue. So this command does not work on grayscale images.

Stretch Contrast This is like “Normalize”, except that it operates on the red, green, and blue channels independently. It often has the useful effect of reducing color casts.

Stretch HSV Does the same as Stretch Contrast but works in HSV color space, rather than RGB color space. It preserves the Hue.

White balance This may enhance images with poor white or black by removing little used colors and stretch the remaining range as much as possible.

Auto Levels This is done by activating the Levels tool (Tools → Color Tools → Levels or Colors → Levels in the image menu), and then pressing the Auto button near the center of the dialog. You will see a preview of the result; you must press Okay for it to take effect. Pressing Cancel instead will cause your image to revert to its previous state.

If you can find a point in the image that ought to be perfect white, and a second point that ought to be perfect black, then you can use the Levels tool to do a semi-automatic adjustment that will often do a good job of fixing both brightness and colors throughout the image. First, bring up the Levels tool as previously described. Now, look down near the bottom of the Layers dialog for three buttons with symbols on them that look like eye-droppers (at least, that is what they are supposed to look like). The one on the left, if you mouse over it, shows its function to be “Pick Black Point”. Click on this, then click on a point in the image that ought to be black—really truly perfectly black, not just sort of dark—and watch the image change. Next, click on the rightmost of the three buttons (“Pick White Point”), and then click a point in the image that ought to be white, and once more watch the image change. If you are happy with the result, click the Okay button otherwise Cancel.

Those are the automated color adjustments: if you find that none of them quite does the job for you, it is time to try one of the interactive color tools. All of these, except one, can be accessed via Tools->Color Tools in the image menu. After you select a color tool, click on the image (anywhere) to activate it and bring up its dialog.

10.1.3.2 Exposure Problems

The simplest tool to use is the **Brightness/Contrast** tool. It is also the least powerful, but in many cases it does everything you need. This tool is often useful for images that are overexposed or underexposed; it is not useful for correcting color casts. The tool gives you two sliders to adjust, for “Brightness” and “Contrast”. If you have the option “Preview” checked (and almost certainly you should), you will see any adjustments you make reflected in the image. When you are happy with the results, press Okay and they will take effect. If you can’t get results that you are happy with, press Cancel and the image will revert to its previous state.

A more sophisticated, and only slightly more difficult, way of correcting exposure problems is to use the Levels tool. The dialog for this tool looks very complicated, but for the basic usage we have in mind here, the only part you need to deal with is the “Input Levels” area, specifically the three triangular sliders that appear below the histogram. We refer you to the **Levels Tool Help** for instructions; but actually the easiest way to learn how to use it is to experiment by moving the three sliders around, and watching how the image is affected. (Make sure that “Preview” is checked at the bottom of the dialog.)

A very powerful way of correcting exposure problems is to use the *Curves* tool. This tool allows you to click and drag control points on a curve, in order to create a function mapping input brightness levels to output brightness levels. The Curves tool can replicate any effect you can achieve with Brightness/-Contrast or the Levels tool, so it is more powerful than either of them. Once again, we refer you to the **Curves Tool Help** for detailed instructions, but the easiest way to learn how to use it is by experimenting.

The most powerful approach to adjusting brightness and contrast across an image, for more expert GIMP users, is to create a new layer above the one you are working on, and then in the Layers dialog set the Mode for the upper layer to “Multiply”. The new layer then serves as a “gain control” layer for the layer below it, with white yielding maximum gain and black yielding a gain of zero. Thus, by painting on the new layer, you can selectively adjust the gain for each area of the image, giving you very fine control. You should try to paint only with smooth gradients, because sudden changes in gain will give rise to spurious edges in the result. Paint only using shades of gray, not colors, unless you want to produce color shifts in the image.

Actually, “Multiply” is not the only mode that is useful for gain control. In fact, “Multiply” mode can only darken parts of an image, never lighten them, so it is only useful where some parts of an image are overexposed. Using “Divide” mode has the opposite effect: it can brighten areas of an image but not darken them. Here is a trick that is often useful for bringing out the maximum amount of detail across all areas of an image:

1. Duplicate the layer (producing a new layer above it).
2. Desaturate the new layer.
3. Apply a Gaussian blur to the result, with a large radius (100 or more).
4. Set Mode in the Layers dialog to Divide.

5. Control the amount of correction by adjusting opacity in the Layers dialog, or by using Brightness/Contrast, Levels, or Curves tools on the new layer.
6. When you are happy with the result, you can use Merge Down to combine the control layer and the original layer into a single layer.

In addition to “Multiply” and “Divide”, you may every so often get useful effects with other layer combination modes, such as “Dodge”, “Burn”, or “Soft Light”. It is all too easy, though, once you start playing with these things, to look away from the computer for a moment and suddenly find that you have just spent an hour twiddling parameters. Be warned: the more options you have, the harder it is to make a decision.

10.1.3.3 Adjusting Hue and Saturation

In our experience, if your image has a color cast---too much red, too much blue, etc---the easiest way to correct it is to use the Levels tool, adjusting levels individually on the red, green, and blue channels. If this doesn't work for you, it might be worth your while to try the Color Balance tool or the Curves tool, but these are much more difficult to use effectively. (They are very good for creating certain types of special effects, though.)

Sometimes it is hard to tell whether you have adjusted colors adequately. A good, objective technique is to find a point in the image that you know should be either white or a shade of gray. Activate the **Color Picker** tool (the eyedropper symbol in the Toolbox), and click on the aforesaid point: this brings up the Color Picker dialog. If the colors are correctly adjusted, then the red, green, and blue components of the reported color should all be equal; if not, then you should see what sort of adjustment you need to make. This technique, when well used, allows even color-blind people to color-correct an image.

If your image is washed out---which can easily happen when you take pictures in bright light---try the **Hue/Saturation** tool, which gives you three sliders to manipulate, for Hue, Lightness, and Saturation. Raising the saturation will probably make the image look better. In some cases it is useful to adjust the lightness at the same time. (“Lightness” here is similar to “Brightness” in the Brightness/Contrast tool, except that they are formed from different combinations of the red, green, and blue channels.) The Hue/Saturation tool gives you the option of adjusting restricted subranges of colors (using the buttons at the top of the dialog), but if you want to get natural-looking colors, in most cases you should avoid doing this.

Tip



Even if an image does not seem washed out, often you can increase its impact by pushing up the saturation a bit. Veterans of the film era sometimes call this trick “Fujifying”, after Fujichrome film, which is notorious for producing highly saturated prints.

When you take pictures in low light conditions, in some cases you have the opposite problem: too much saturation. In this case too the Hue/Saturation tool is a good one to use, only by reducing the saturation instead of increasing it.

10.1.4 Adjusting Sharpness

10.1.4.1 Unblurring

If the focus on the camera is not set perfectly, or the camera is moving when the picture is taken, the result is a blurred image. If there is a lot of blurring, you probably won't be able to do much about it with any technique, but if there is only a moderate amount, you should be able to improve the image.

The most generally useful technique for sharpening a fuzzy image is called the **Sharpen (Unsharp Mask)**. In spite of the rather confusing name, which derives from its origins as a technique used by film developers, its result is to make the image sharper, not “unsharp”. It is a plug-in, and you can access it as Filters->Enhance->Sharpen (Unsharp Mask) in the image menu. There are two parameters, “Radius” and “Amount”. The default values often work pretty well, so you should try them first. Increasing either the radius or the amount increases the strength of the effect. Don't get carried away, though: if you make

the unsharp mask too strong, it will amplify noise in the image and also give rise to visible artifacts where there are sharp edges.

Tip



Sometimes using Sharpen (Unsharp Mask) can cause color distortion where there are strong contrasts in an image. When this happens, you can often get better results by decomposing the image into separate Hue-Saturation-Value (HSV) layers, and running Sharpen (Unsharp Mask) on the Value layer only, then recomposing. This works because the human eye has much finer resolution for brightness than for color. See the sections on [Decompose](#) and [Compose](#) for more information.

In some situations, you may be able to get useful results by selectively sharpening specific parts of an image using the [Blur or Sharpen](#) tool from the Toolbox, in "Sharpen" mode. This allows you to increase the sharpness in areas by painting over them with any paintbrush. You should be restrained about this, though, or the results will not look very natural: sharpening increases the apparent sharpness of edges in the image, but also amplifies noise.

10.1.4.2 Reducing Graininess

When you take pictures in low-light conditions or with a very fast exposure time, the camera does not get enough data to make good estimates of the true color at each pixel, and consequently the resulting image looks grainy. You can "smooth out" the graininess by blurring the image, but then you will also lose sharpness. There are a couple of approaches that may give better results. Probably the best, if the graininess is not too bad, is to use the filter called [Selective Blur](#), setting the blurring radius to 1 or 2 pixels. The other approach is to use the [Despeckle](#) filter. This has a nice preview, so you can play with the settings and try to find some that give good results. When graininess is really bad, though, it is often very difficult to fix by anything except heroic measures (i.e., retouching with paint tools).

10.1.4.3 Softening

Every so often you have the opposite problem: an image is *too* crisp. The solution is to blur it a bit: fortunately blurring an image is much easier than sharpening it. Since you probably don't want to blur it very much, the simplest method is to use the "Blur" plug-in, accessed via Filters->Blur->Blur from the image menu. This will soften the focus of the image a little bit. If you want more softening, just repeat until you get the result you desire.

10.1.5 Removing Unwanted Objects from an Image


There are two kinds of objects you might want to remove from an image: first, artifacts caused by junk such as dust or hair on the lens; second, things that were really present but impair the quality of the image, such as a telephone wire running across the edge of a beautiful mountain landscape.

10.1.5.1 Despeckling

A good tool for removing dust and other types of lens grunge is the [Despeckle](#) filter, accessed as Filters->Enhance->Despeckle from the image menu. Very important: to use this filter effectively, you must begin by making a small selection containing the artifact and a small area around it. The selection must be small enough so that the artifact pixels are statistically distinguishable from the other pixels inside the selection. If you try to run despeckle on the whole image, you will hardly ever get anything useful. Once you have created a reasonable selection, activate Despeckle, and watch the preview as you adjust the parameters. If you are lucky, you will be able to find a setting that removes the junk while minimally affecting the area around it. The more the junk stands out from the area around it, the better your results are likely to be. If it isn't working for you, it might be worthwhile to cancel the filter, create a different selection, and then try again.

If you have more than one artifact in the image, it is necessary to use Despeckle on each individually.

10.1.5.2 Garbage Removal

The most useful method for removing unwanted “clutter” from an image is the **Clone**  tool, which allows you to paint over one part of an image using pixel data taken from another part (or even from a different image). The trick to using the clone tool effectively is to be able to find a different part of the image that can be used to “copy over” the unwanted part: if the area surrounding the unwanted object is very different from the rest of the image, you won’t have much luck. For example, if you have a lovely beach scene, with a nasty human walking across the beach who you would like to teleport away, you will probably be able to find an empty part of the beach that looks similar to the part he is walking across, and use it to clone over him. It is quite astonishing how natural the results can look when this technique works well.

Consult the **Clone Tool Help** for more detailed instructions. Cloning is as much an art as a science, and the more you practice at it, the better you will get. At first it may seem impossible to produce anything except ugly blotches, but persistence will pay off.

Another tool looking very much as the clone tool, but smarter, is the **healing tool** which also takes the area around the destination into account when cloning. A typical usage is removal of wrinkles and other minor errors in images.

In some cases you may be able to get good results by simply cutting out the offending object from the image, and then using a plug-in called “Resynthesizer” to fill in the void. This plug-in is not included with the main GIMP distribution, but it can be obtained from the author’s web site [[PLUGIN-RESYNTH](#)]. As with many things, your mileage may vary.

10.1.5.3 Removing Red-eye

When you take a flash picture of somebody who is looking directly toward the camera, the iris of the eye can bounce the light of the flash back toward the camera in such a way as to make the eye appear bright red: this effect is called “red eye”, and looks very bizarre. Many modern cameras have special flash modes that minimize red-eye, but they only work if you use them, and even then they don’t always work perfectly. Interestingly, the same effect occurs with animals, but the eyes may show up as other colors, such as green.

From version 2.4, GIMP incorporated a special **remove red eye** filter. Make a selection with one of the selection tools of the red part of the eye and then choose the “Remove Red Eye” filter. Perhaps you have to fiddle around a bit with the threshold slider to get the right color.

10.1.6 Saving Your Results

10.1.6.1 Files

What file format should you use to save the results of your work, and should you resize it? The answers depend on what you intend to use the image for.

- If you intend to open the image in GIMP again for further work, you should save it in GIMP’s native XCF format (i. e., name it something.xcf), because this is the only format that guarantees that none of the information in the image is lost.
- If you intend to print the image on paper, you should avoid shrinking the image, except by cropping it. The reason is that printers are capable of achieving much higher resolutions than video monitors — 600 to 1400 dpi (“dots per inch”, the physical density) for typical printers, as compared to 72 to 100 pixels per inch for monitors. A 3000 x 5000-pixel image looks huge on a monitor, but it only comes to about 5 inches by 8 inches on paper at 600 ppi. There is usually no good reason to *expand* the image either: you can’t increase the true resolution that way, and it can always be scaled up at the time it is printed. As for the file format, it will usually be fine to use JPEG at a quality level of 75 to 85. In rare cases, where there are large swaths of nearly uniform color, you may need to set the quality level even higher or use a lossless format such as TIFF instead.
- If you intend to display the image on screen or project it with a video projector, bear in mind that the highest screen resolution for most commonly available systems is 1600 x 1200, so there is nothing to gain by keeping the image larger than that. For this purpose, the JPEG format is almost always a good choice.

- If you want to put the image on a web page or send it by email, it is a good idea to make every effort to keep the file size as small as possible. First, scale the image down to the smallest size that makes it possible to see the relevant details (bear in mind that other people may be using different sized monitors and/or different monitor resolution settings). Second, save the image as a JPEG file. In the JPEG save dialog, check the option to “Preview in image window”, and then adjust the Quality slider to the lowest level that gives you acceptable image quality. (You will see in the image the effects of each change.) Make sure that the image is zoomed at 1:1 while you do this, so you are not misled by the effects of zooming.


See the [File Formats](#) section for more information.

10.1.6.2 Printing Your Photos

As in most applications, in GIMP, printing needs to go to main menu File → Print. However it is very useful to keep in mind some elementary concepts to prevent some unpleasant surprises when looking at result, or to cure them if that occurs. You must always remember:

- that image displayed on the screen is in RGB mode and printing will be in CMYK mode; consequently color feature you’ll get on printed sheet will not be exactly what you was waiting for. That depends on the used corresponding chart. For the curious ones some adding explanations can be got through a click on these useful Wikipedia links:
 - ICC-Profile [[WKPD-ICC](#)]
 - CMYK [[WKPD-CMYK](#)]
 - Gamut [[WKPD-GAMUT](#)]
- that a screen resolution is roughly within a range from 75 up to 100 dpi; a printer resolution is about 10x higher (or more) than a screen one; printed image size depends on available pixels and resolution; so actual printed size doesn’t correspond inevitably to what is displayed on screen nor available sheet size.

Consequently, before any printing it is relevant to go to: Image → Print size and choose here your

convenient output size in “print size” box adjusting either sizes or resolution. The  symbol shows that the both values are linked. You can dissociate x and y resolution by clicking on that symbol, but it is risky! Probably this possibility is open because printers are built with different x vs. y resolutions. Nevertheless if you unlinked them you can be very surprised! You can try this in special effects.

Last recommendation: think of checking your margins as well as centering. It would be a pity if a too much large margin cuts off some part of your image or if an inappropriate centering damages your work especially if you use a special photo paper.

10.1.6.3 EXIF Data

Modern digital cameras, when you take a picture, add information to the data file about the camera settings and the circumstances under which the picture was taken. This data is included in JPEG or TIFF files in a structured format called EXIF. For JPEG files, GIMP is capable of maintaining EXIF data, if it is built appropriately: it depends on a library called “libexif”, which may not be available on all systems. If GIMP is built with EXIF support enabled, then loading a JPEG file with EXIF data, and resaving the resulting image in JPEG format, will cause the EXIF data to be preserved unchanged. This is not, strictly speaking, the right way for an image editor to handle EXIF data, but it is better than simply removing it, which is what earlier versions of GIMP did.

If you would like to see the contents of the EXIF data, you can use the [metadata-viewer](#) plug-in. you can access it as Image->Metadata->View metadata from the menu.

Chapter 11

Color Management with GIMP

11.1 Color Management in GIMP

Many devices you use in your design or photography workflow, like digital photo cameras, scanners, displays, printers etc., have their own color reproduction characteristics. If those are not taken into account during opening, editing and saving, harmful adjustments can be done to images. With GIMP you can have reliable output for both Web and print.

Figure 11.1 Image Processing Workflow



11.1.1 Problems of a non Color Managed Workflow

The basic problem of image manipulation without color management is that you do simply not see what you do. This affects two different areas:

1. There are differences in Colors caused by different color characteristics of different devices like cameras, scanners, displays or printers
2. There are differences in Colors caused by the limitations of the colorspace a specific device is able to handle

The main purpose of color management is to avoid such problems. The approach taken to do so involves the addition of a description of the color characteristic to an image or devices.

These descriptions are called *color profile*. A color profile is basically a look-up table to translate the specific color characteristic of a device to a device-independent color space - the so called working-space.

All the image manipulation is then done to images in the working-space. In addition to that the color profile of a device can be used to simulate how colors would look on that device.

The creation of color profiles is most often done by the manufacturer of the devices themselves. To make these profiles usable independent of platform and operating system, the ICC (International Color Consortium) created a standard called ICC-profile that describes how color profiles are stored to files and embedded into images.

11.1.2 Introduction to a Color Managed Workflow

Tip

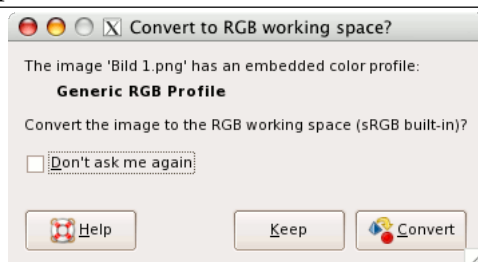


Most of the parameters and profiles described here can be set in the GIMP preferences. Please see Section 12.1.3 for details.

11.1.2.1 Input

Most digital cameras embed a color profile to individual photo files without user interaction. Digital scanners usually come with a color profile, which they also attach to the scanned images.

Figure 11.2 Applying the ICC-profile



When opening an image with an embedded color profile, GIMP offers to convert the file to the RGB working color space. This is sRGB by default and it is recommended that all work is done in that color space. Should you however decide to keep the embedded color profile, the image will however still be displayed correctly.

In case for some reason a color profile is not embedded in the image and you know (or have a good guess) which one it should be, you can manually assign it to that image.

11.1.2.2 Display

For the best results, you need a color profile for your monitor. If a monitor profile is configured, either system-wide or in the Color Management section of the GIMP Preferences dialog, the image colors will be displayed most accurately.

One of the most important GIMP commands to work with color management is described in Section 16.5.10.

If you do not have a color profile for your monitor, you can create it using hardware calibration and measurement tools. On UNIX systems you will need Argyll Color Management System [ARGYLLCMS] and/or LProf [LPROF] to create color profiles.

11.1.2.2.1 Display Calibration and Profiling

For displays there are two steps involved. One is called calibration and the other is called profiling. Also, calibration generally involves two steps. The first involves adjusting external monitor controls such as Contrast, Brightness, Color Temperature, etc, and it is highly dependent on the specific monitor. In addition there are further adjustments that are loaded into the video card memory to bring the monitor as close to a standard state as possible. This information is stored in the monitor profile in the so-called

vgct tag. Probably under Windows XP or Mac OS, the operating system loads this information (LUT) in the video card in the process of starting your computer. Under Linux, at present you have to use an external program such as xcalib or dispwin. (If one just does a simple visual calibration using a web site such as that of Norman Koren, one might only use xgamma to load a gamma value.)

The second step, profiling, derives a set of rules which allow GIMP to translate RGB values in the image file into appropriate colors on the screen. This is also stored in the monitor profile. It doesn't change the RGB values in the image, but it does change which values are sent to the video card (which already contains the vgct LUT).

11.1.2.3 Print Simulation

Using GIMP, you can easily get a preview of what your image will look like on paper. Given a color profile for your printer, the display can be switched into Soft Proof mode. In such a simulated printout, colors that cannot be reproduced will optionally be marked with neutral gray color, allowing you to correct such mistakes before sending your images to the printer.

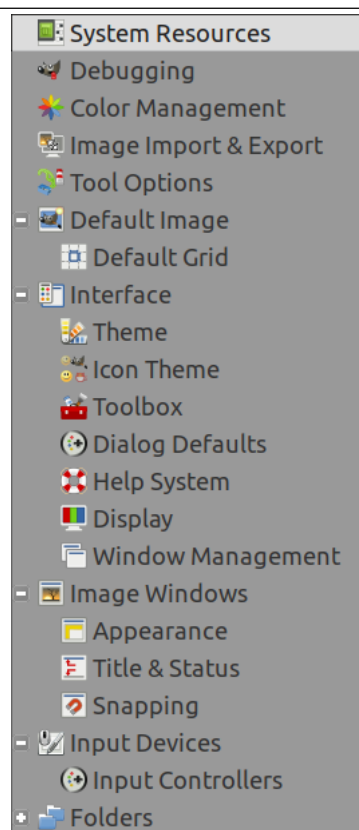
Chapter 12

Enrich my GIMP

12.1 Preferences Dialog

12.1.1 Introduction

Figure 12.1 List of preference pages

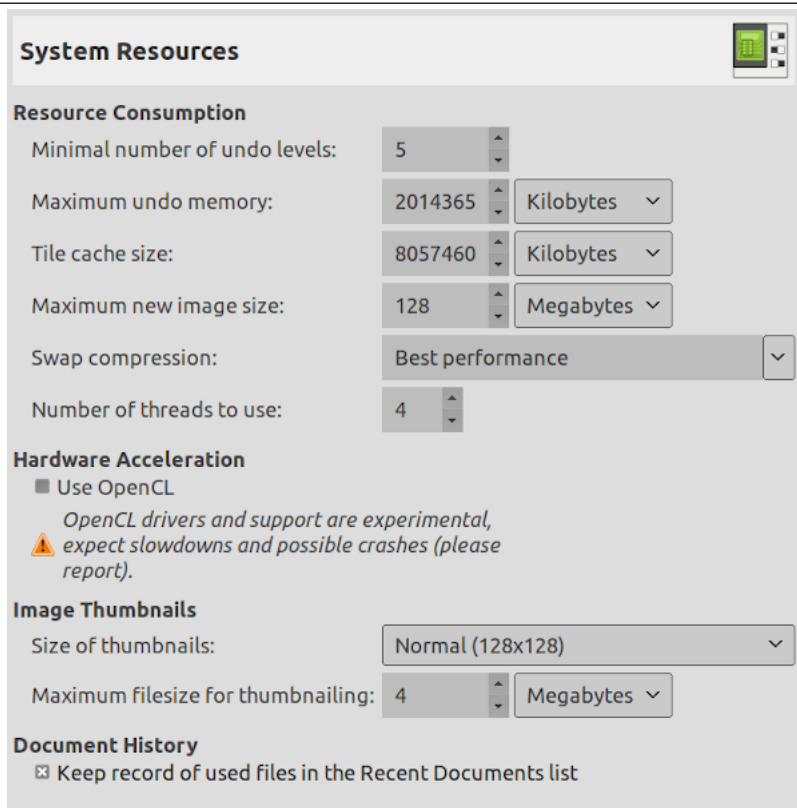


The preferences dialog can be accessed from the image menu-bar, through Edit → Preferences. It lets you customize many aspects of the way GIMP works. The following sections detail the settings that you can customize, and what they affect.

All of the Preferences information is stored in a file called `gimprc` in your personal GIMP directory, so if you are a “power user” who would rather work with a text editor than a graphical interface, you can alter preferences by editing that file. If you do, and you are on a Linux system, then `man gimprc` will give you a lot of technical information about the contents of the file and what they are used for.

12.1.2 System Resources

Figure 12.2 System Resources



This page lets you customize the amount of system memory allocated for various purposes. It also allows you to set the size of thumbnail files that GIMP produces.

12.1.2.1 Options

Resource Consumption

Minimal number of undo levels GIMP allows you to undo most actions by maintaining an “Undo History” for each image, for which a certain amount of memory is allocated. Regardless of memory usage, however, GIMP always permits some minimal number of the most recent actions to be undone: this is the number specified here. See Section 3.3 for more information about GIMP’s Undo mechanism.

Maximum undo memory This is the amount of undo memory allocated for each image. If the Undo History size exceeds this, the oldest points are deleted, unless this would result in fewer points being present than the minimal number specified above.

Tile cache size This is the amount of system RAM allocated for GIMP image data. If GIMP requires more memory than this, it begins to swap to disk, which may in some circumstances cause a dramatic slowdown. You are given an opportunity to set this number when you install GIMP, but you can alter it here. See [How to Set Your Tile Cache](#) for more information.

Maximum new image size This is not a hard constraint: if you try to create a new image larger than the specified size, you are asked to confirm that you really want to do it. This is to prevent you from accidentally creating images much larger than you intend, which can either crash GIMP or cause it to respond verrrrrrry slowwwwwwwly.

Number of threads to use Multi-threading allows making use of multiple cores for processing. Not all features make use of that for the moment. A point of interest is that multi-threading happens through GEGL processing, but also in GIMP core itself, for instance to separate painting from display.

Hardware acceleration

Use OpenCL OpenCL is an acronym for Open Computing Language (see [Wikipedia](#)). This option, improves the management of relations between the CPU and the graphic processing unit (GPU). It is an experimental feature; slowdowns and crashes are possible.

Image Thumbnails

Size of thumbnails This options allows you to set the size of the thumbnails shown in the File Open dialog (and also saved for possible use by other programs). The options are “No thumbnails”, “Normal (128x128)”, and “Large (256x256)”.

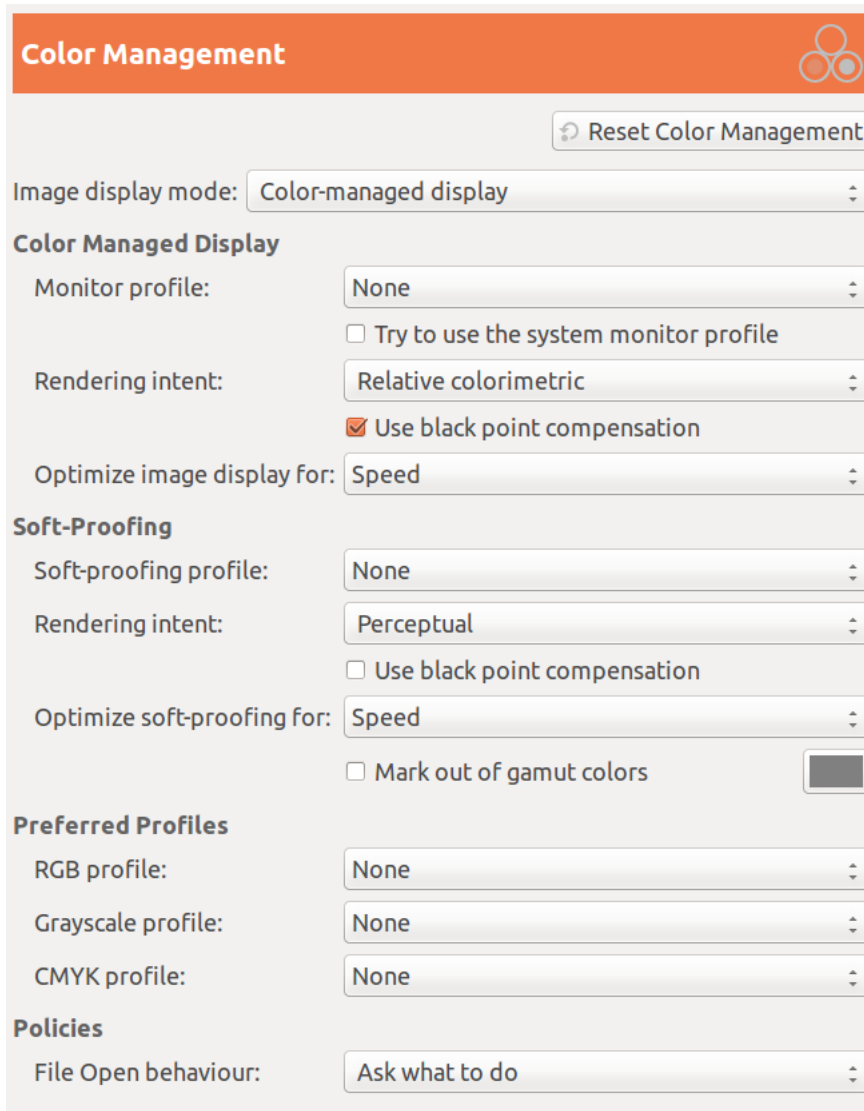
Maximum filesize for thumbnailing If an image file is larger than the specified maximum size, GIMP will not generate a thumbnail for it. This options allows you to prevent thumbnailing of extremely large image files from slowing GIMP to a crawl.

Document History

Keep record of used files in the Recent Documents list When checked, files you have opened will be saved in the Document history. You can access the list of files with the [Document history dialog](#) from the image menu-bar : File → Open Recent → Document History.

12.1.3 Color Management

Figure 12.3 Color Management Preferences



12.1.3.1 Options

This page lets you customize the GIMP color management.

Some of the options let you choose a color profile from a menu. If the desired profile is not in the menu yet, you can add it by clicking on the Select color profile from disk... item.

Tip



Files containing color profiles are easily recognizable by their `.icc` suffix. In addition to that they are usually stored all together in only a few places. If you are running GIMP on Mac OS X, you should try `/Library/ColorSync/Profiles/` and `Library/Printers/[manufacturer]/Profiles.`

Image display mode Using this option you can decide how the GIMP color management operates. There are three modes you can choose from:

- **No color management:** choosing this selection shuts down the color management in GIMP completely.
- **Color managed display:** with this selection you can enable the GIMP color management to provide a fully corrected display of the images according to the given color profile for the display.
- **Soft-proofing:** when choosing this option, you enable the GIMP color management not only to apply the profile for the display, but also the selected printer simulation profile. Doing so, you can preview the color results of a print with that printer.

Note



Please note, that the GIMP color management is used to enhance the display of images and the embedding of profiles to image files only. Especially are the options you choose in this dialog in no way used for printing from within GIMP. This is because the printing is a special task done by a more specialized printing engine that is no part of GIMP.

Color Managed Display Monitor profile

- None : GIMP uses the colorimetric profile of your monitor.
- Select color profile from disk : if you have one.
- Try to use the system monitor profile : If checked, GIMP will try to use the display color profile of the system windows handler. Else, the configured monitor profile is used.

Rendering intent

- This option is about how colors are converted from the color space of your image to your display device. Four modes are available: "Perceptual", "Relative colorimetric", "Saturation" and " Absolute colorimetric".

Relative colorimetric is usually the best choice (default). Unless you use a LUT monitor profile (most monitor profile are matrix), choosing perceptual intent actually gives you relative colorimetric.

Use black point compensation

- This option is checked by default. Do use black point compensation unless you have a reason not to.

Optimize image display for:

- Two options: Speed and Precision/Color fidelity. “Speed” is activated by default. If not, image display might be better at the cost of speed.

Soft-proofing> Soft-proofing is a mechanism that allows you to see on your screen what printing on paper will look. More generally, it is soft-proofing from the color space of your image to another color color space (printer or other output device).

Soft-proofing profile

None is the choice by default. The drop-down list offers the possibility of Select color profile from disk...

Rendering intent As above, four modes: “Perceptual”, “Relative colorimetric”, “Saturation” and “Absolute colorimetric”. Try them all and choose what looks the best.

Use black point compensation

Try with and without black point compensation and choose what looks best.

Optimize soft-proofing for:

Two options: Speed and Precision/Color fidelity. “Speed” is activated by default. If not, soft-proofing might be better at the cost of speed.

Mark out of gamut colors

When this box is checked, the soft-proofing will mark color that can not be represented in the target color space. On the right, a color button, when clicked, opens a color selector to choose the wanted color.

Preferred profiles RGB profile

Default is “None” and the built-in RGB profile is used. You can select another RGB working space color profile from disk: it will be offered next to the built-in profile when a color profile can be chosen.

Grayscale profile

Default is “None” and the built-in Grayscale profile is used. You can select another Grayscale working space color profile from disk: it will be offered next to the built-in profile when a color profile can be chosen.

CMYK profile

Default is “None”. You can select a CMYK working space color profile from disk to convert RGB to CMYK.

Policies File Open Behavior

Default is “Ask what to do”. You can also select “Keep embedded profile” or “Convert to preferred RGB color profile” to indicate how to treat embedded color profiles when opening an image file.

Note

For more explanations:

- ICC Profiles are explained in Wikipedia [[WKPD-ICC](#)].
- See OpenICC project ([\[OPENICC\]](#)) where GIMP and others great names of free infography contribute to.



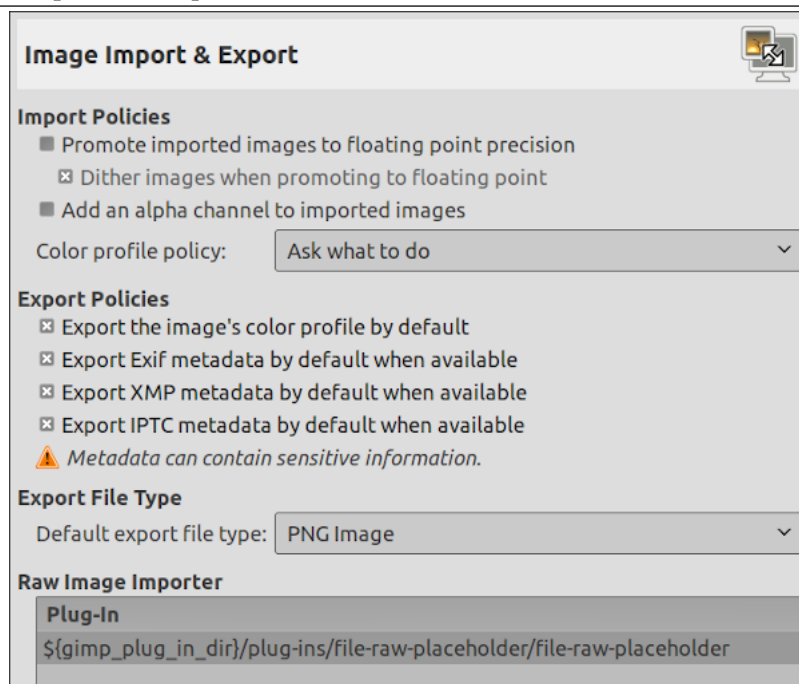
Many profiles to load from the web:

- ICC sRGB Workspace: ICCsRGB [[ICCsRGB](#)]
- Adobe RGB98 Workspace : Adobe RGB (1998) [[AdobeRGB](#)]
- ECI (European Color Initiative) Profiles: ECI [[ECI](#)]

Filter Dialogs Show advanced color options: advanced color options in filter dialogs are not visible when this option is not checked.

12.1.4 Image Import and Export

Figure 12.4 Image Import and Export



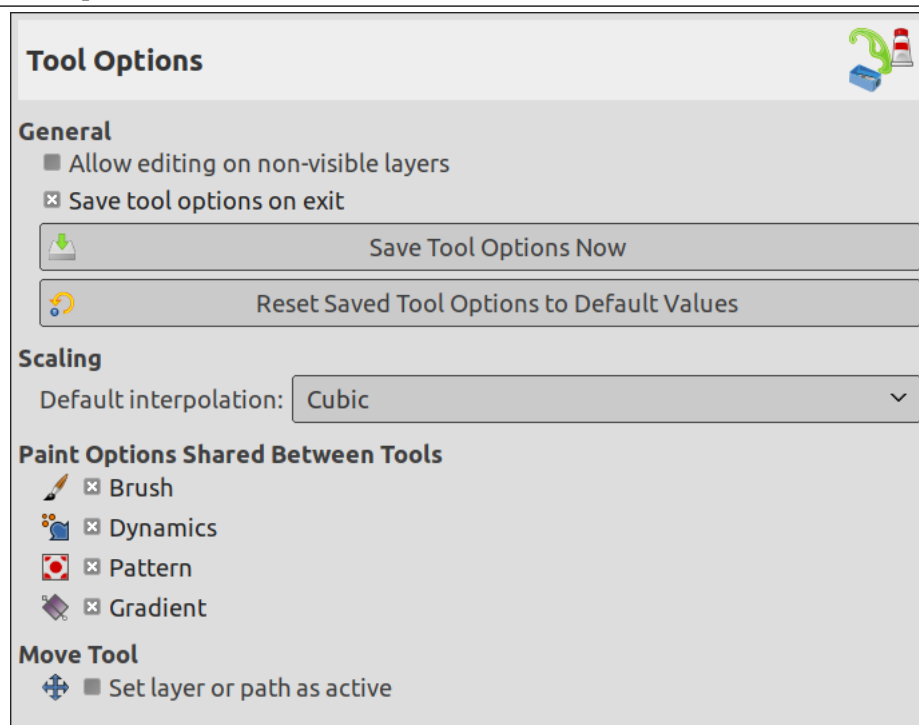
This page lets you customize importing and exporting images.

12.1.4.1 Options

These options are self-explanatory and pop-up helps give some more information.

12.1.5 Tool Options

Figure 12.5 Tool Options Preferences



This page lets you customize several aspects of the behavior of tools.

12.1.5.1 Options

General

Allow editing on non-visible layers You can edit layers with disabled visibility (the eye icon in the layer dock).

Save Tool Options On Exit Self explanatory

Save Tool Options Now Self explanatory

Reset Saved Tool Options To Default Values Self explanatory

Scaling

Default interpolation When you scale something, each pixel in the result is calculated by **interpolating** several pixels in the source. This option determines the default interpolation method: it can always be changed, though, in the Tool Options dialog.

There are four choices:

None This is the fastest method, but it's quite crude: you should only consider using it if your machine is very seriously speed-impaired.

Linear This used to be the default, and is good enough for most purposes.

Cubic This is the best choice (although it can actually look worse than Linear for some types of images), but also the slowest. Since GIMP 2.6, this method is the default.

NoHalo This method performs a high quality interpolation. Use the NoHalo method when you downscale an image to less than a half of the original size.

LoHalo This method performs a high quality interpolation. Use the LoHalo method when you do not reduce the size much (rotate, shear).

Paint Options Shared Between Tools

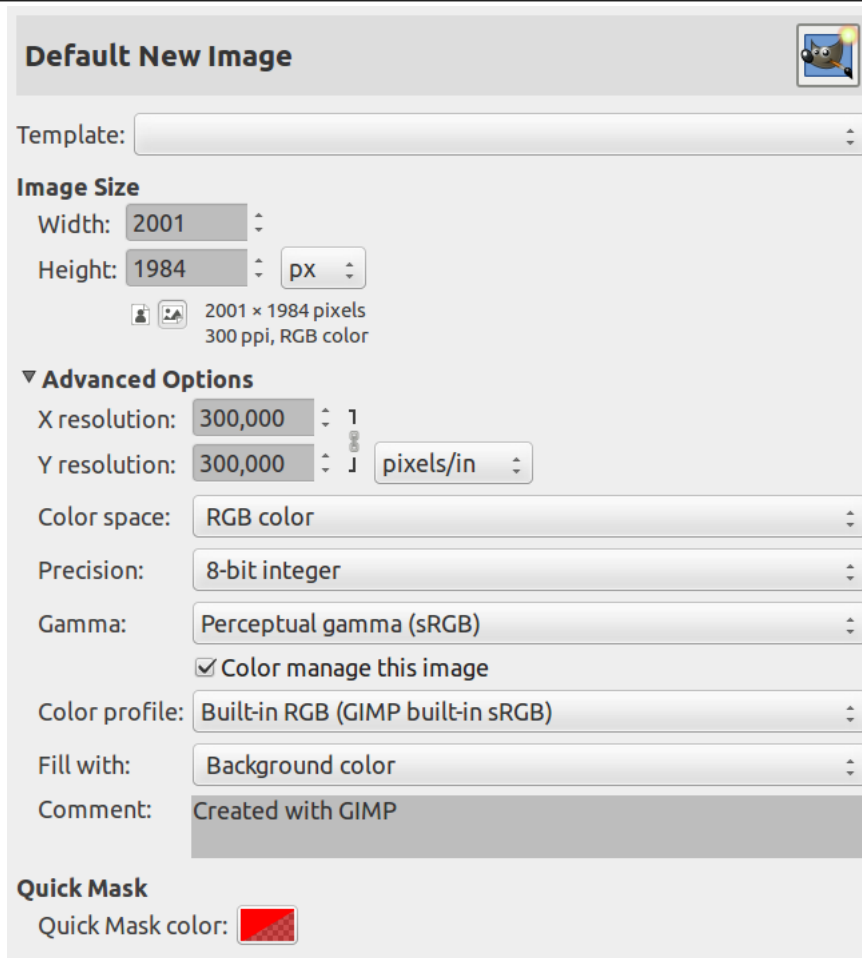
Brush, Dynamics, Pattern, Gradient You can decide here whether changing the brush etc for one tool should cause the new item to be used for all tools, or whether each individual tool (pencil, paintbrush, airbrush, etc) should remember the item that was last used for it specifically.

Move tool

Set layer or path as active You can decide here whether changing the current layer or path when using the move tool and without pressing any key.

12.1.6 Default Image Preferences

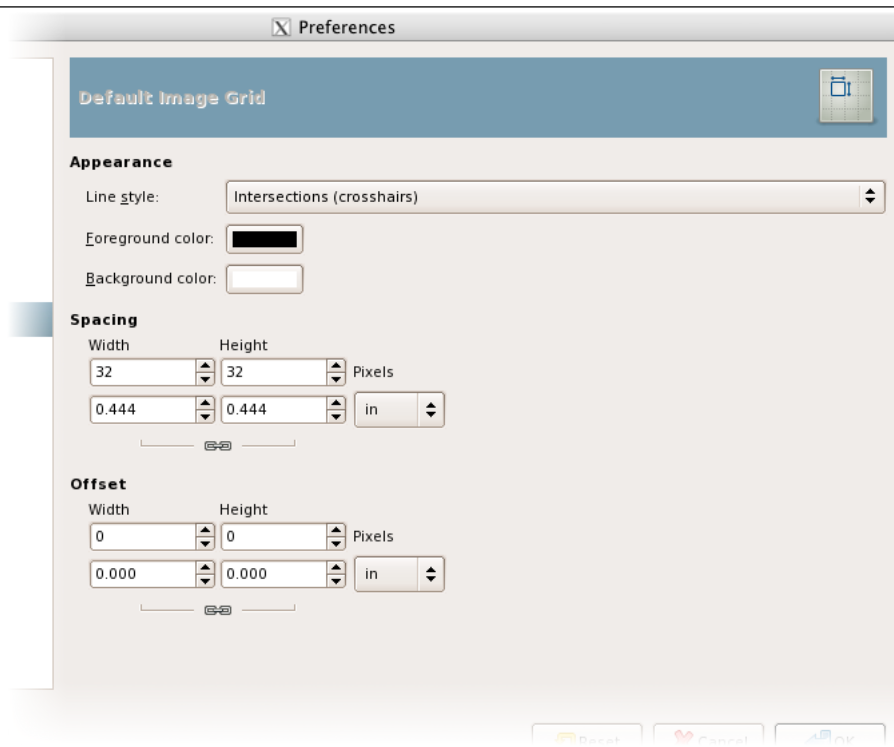
Figure 12.6 Default New Image Preferences



This tab lets you customize the default settings for the New Image dialog. See the [New Image Dialog](#) section for an explanation of what each of the values means.

12.1.7 Default Image Grid

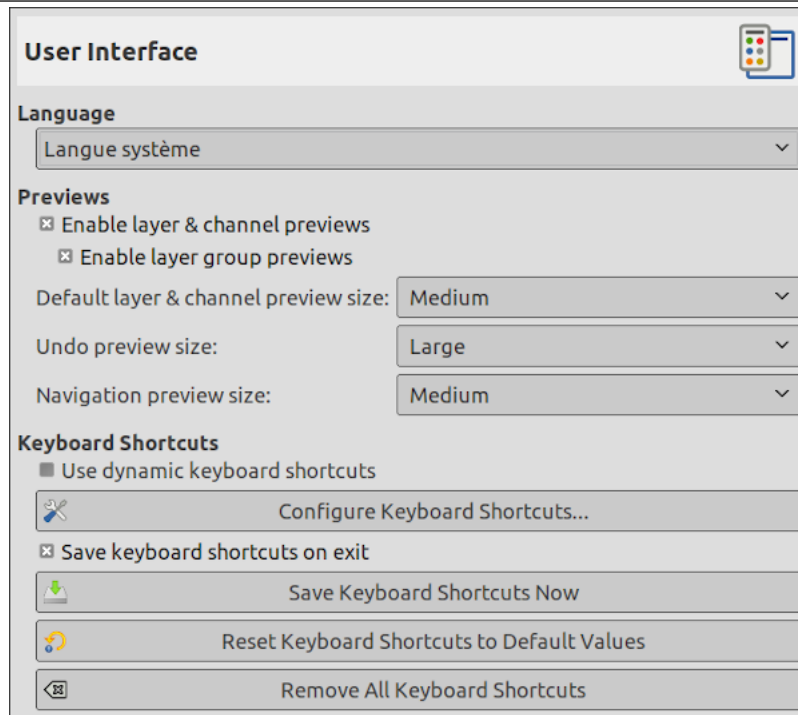
Figure 12.7 Default Grid Preferences



This page lets you customize the default properties of GIMP's grid, which can be toggled on or off using View → Show Grid from the image menu. The settings here match those in the Configure Image Grid dialog, which can be used to reconfigure the grid for an existing image, by choosing Image → Configure Grid from the image menu. See the [Configure Grid dialog](#) section for information on the meaning of each of the settings.

12.1.8 Interface

Figure 12.8 Assorted Interface Preferences



This page lets you customize language, layer/channel previews and keyboard shortcuts.

Options

Language The GIMP's default language is that of your system. You can select another language in the drop-down list. You have to start GIMP again to make this change effective. Please refer to Section 2.1.2.

Previews By default, GIMP shows miniature previews of the contents of layers and channels in several places, including the Layers dialog. If for some reason you would prefer to disable these, you can do it by unchecking Enable layer and channel previews and Enable layer group layers previews. If you do want previews to be shown, you can customize their sizes using the menus for Default layer and channel preview size and Navigation preview size.

You can also customize the Undo preview size and the Navigation preview size.

Keyboard Shortcuts Any menu item can be activated by holding down **Alt** and pressing a sequence of keys. Normally, the key associated with each menu entry is shown as an underlined letter in the text, called *accelerator*. If for some reason you would prefer the underlines to go away (maybe because you think they're ugly and you don't use them anyway), then you can make this happen by unchecking Show menu mnemonics.

GIMP can give you the ability to create keyboard shortcuts (key combinations that activate a menu entry) dynamically, by pressing the keys while the pointer hovers over the desired menu entry. However, this capability is disabled by default, because it might lead novice users to accidentally overwrite the standard keyboard shortcuts. If you want to enable it, check Use dynamics keyboard shortcuts here.

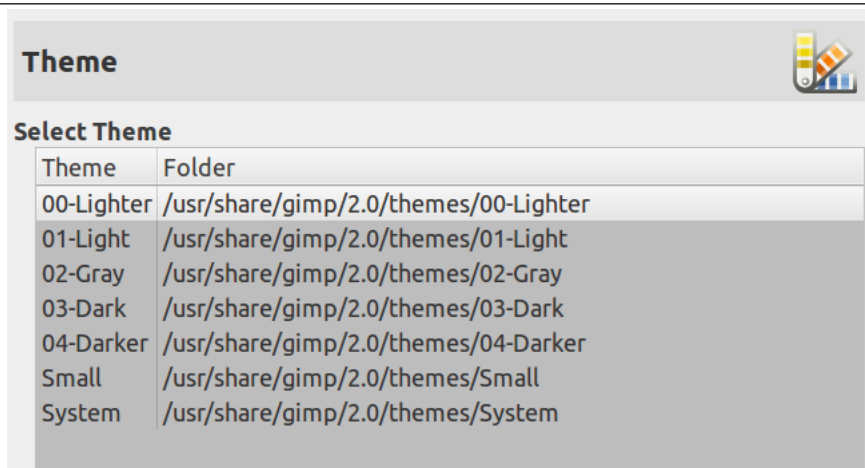
Pressing the button for Configure Keyboard Shortcuts brings up the Shortcut Editor, which gives you a graphical interface to select menu items and assign shortcuts to them.

If you change shortcuts, you will probably want your changes to continue to apply in future GIMP sessions. If not, uncheck Save Keyboard Shortcuts on exit. But remember that you have done this, or you may be frustrated later. If you don't want to save shortcuts on exit every session, you can save the current settings at any time using the Save Keyboard Shortcuts Now button, and they will be applied to future sessions. If you decide that you have made some bad decisions concerning

shortcuts, you can reset them to their original state by pressing Reset Saved Keyboard Shortcuts to Default Values. A new possibility: Remove All Keyboard Shortcuts.

12.1.9 Theme

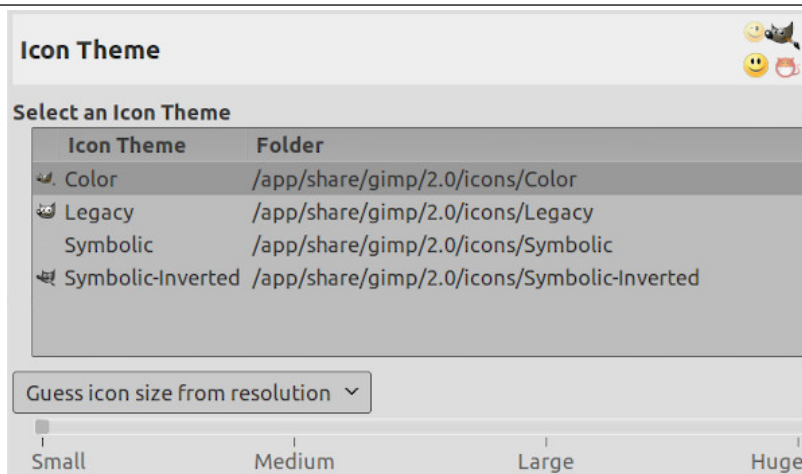
Figure 12.9 Theme Preference



This page lets you select a theme, which determines many aspects of the appearance of the GIMP user interface. Clicking on a theme in the list causes it to be applied immediately, so it is easy to see the result and change your mind if you don't like it.

12.1.10 Icon Theme

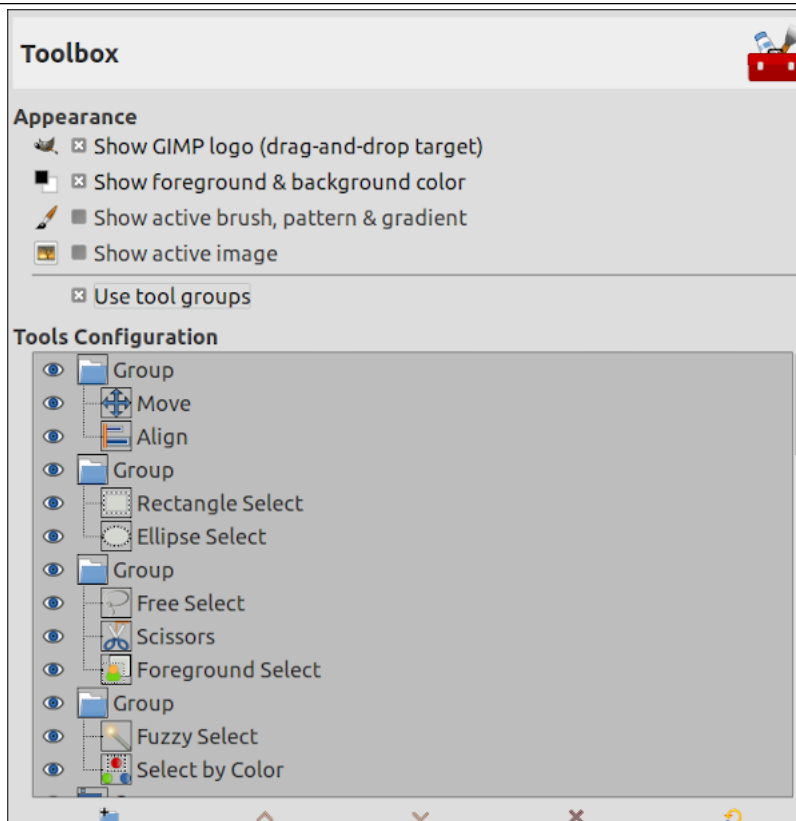
Figure 12.10 Icon Theme Preference



This page lets you select a theme for the icons of the GIMP user interface. Test them: you will see the result instantly in this preference dialog.

12.1.11 Toolbox

Figure 12.11 Toolbox Preferences



12.1.11.1 Options

Figure 12.12 Default Toolbox appearance



This page lets you customize the appearance of the Toolbox, by deciding whether the three “context information” areas should be shown at the bottom.

Appearance

Show GIMP logo (drag-and-drop target) You can click-drag-and-drop an image from a file browser into this area to open it.

Show foreground and background color Controls whether the color area on the left (2) appears in the Toolbox.

Show active brush, pattern, and gradient Controls whether the area in the center (3), with the brush, pattern, and gradient icons, appears in the Toolbox.

Show active image Controls whether a preview of the currently active image appears on the right (4).

Use tool groups Since GIMP-2.10.18, tools can be grouped in the toolbox (see Section 14.1.2).

Tools configuration

In this list, tools with an eye are present in the Toolbox. By default, color tools have no eye: you can add them to the Toolbox by clicking the corresponding checkbox to create an eye.

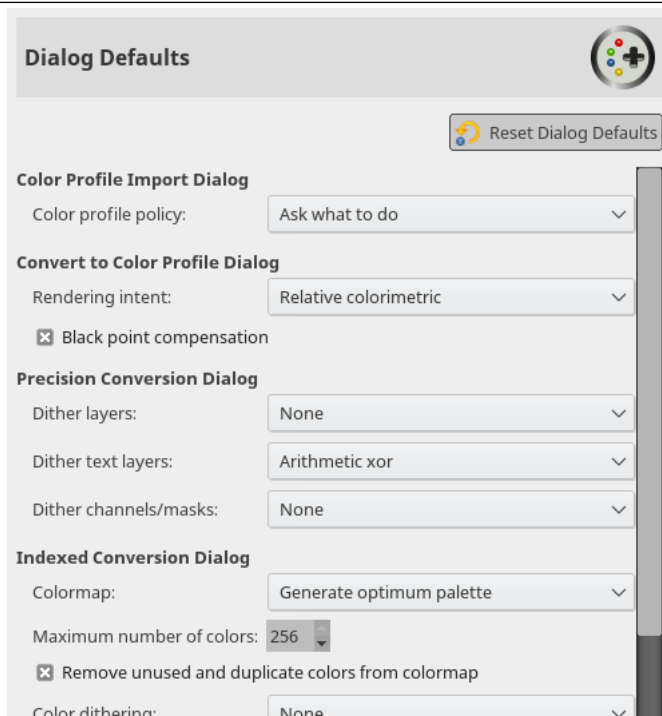
Since GIMP-2.10.18, tools are grouped. You can:

- **Move groups** by using drag-and-drop or the arrow buttons at the bottom of the dialog.
- **Create a new group** by using the Create a new tool group at the bottom of the dialog. This tool group is created empty.

Changes take effect immediately.

12.1.12 Dialog Defaults

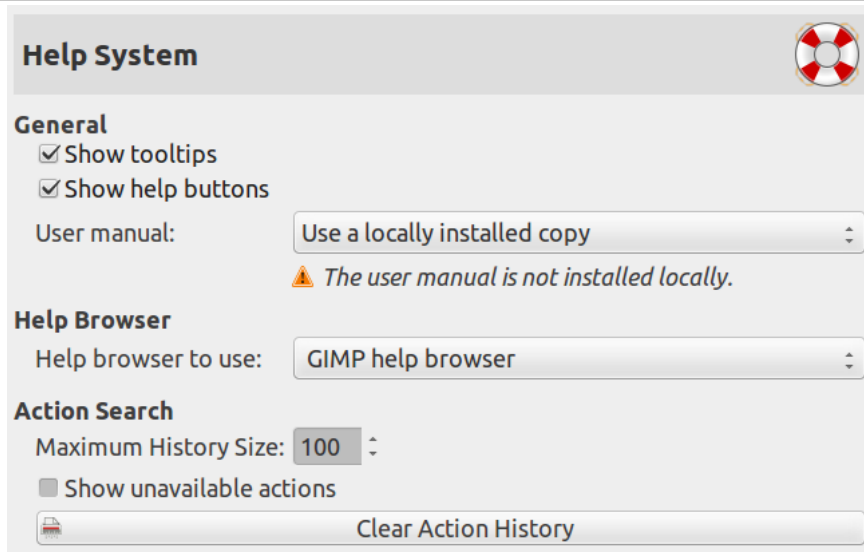
Figure 12.13 Dialog Default



This page lets you customize the default parameters of dialogs.

12.1.13 Help System

Figure 12.14 Help System Preferences



This page lets you customize the behaviour of the GIMP help system.

12.1.13.1 Options

General

Show tool tips Tool tips are small help pop-ups that appear when the pointer hovers for a moment over some element of the interface, such as a button or icon. Sometimes they explain what the element does; sometimes they give you hints about non-obvious ways to use it. If you find them too distracting, you can disable them here by unchecking this option. We recommend that you leave them enabled unless you are a very advanced user.

Show help buttons This option controls whether the help buttons are shown on every tool dialog, which may be used alternatively to invoke the help system.

User manual This drop-down list lets you select between Use a locally installed copy and Use the online version. See Section 16.12.2.

Help Browser

Help browser to use GIMP Help is supplied in the form of HTML files, i. e., web pages. You can view them using either a special help browser that comes with GIMP, or a web browser of your choice. Here you choose which option to use. Because the help pages were carefully checked to make sure they work well with GIMP's browser, whereas other web browsers are somewhat variable in their support of features, the safer option is to use the internal browser; but really any modern web browser should be okay.

Note



Note that the GIMP help browser is not available on all platforms. If it is missing, this option is hidden and the standard web browser will be used to read the help pages.

Action Search

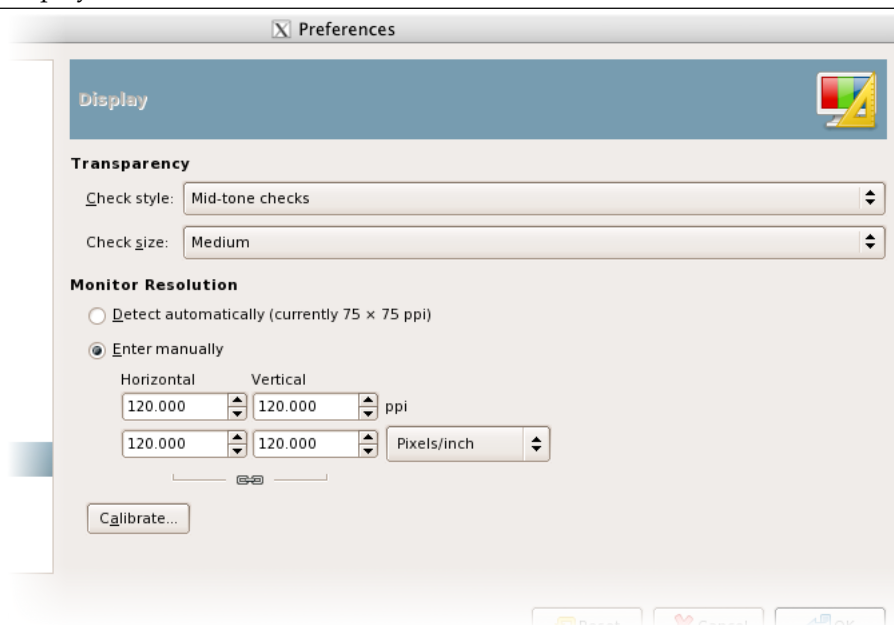
Maximum History Size Default value is 100 (0-1000) items in the history.

Show unavailable actions When this check-box is enabled, a search of actions will also return inactive actions.

Clear Action History Self-explanatory.

12.1.14 Display

Figure 12.15 Display Preferences



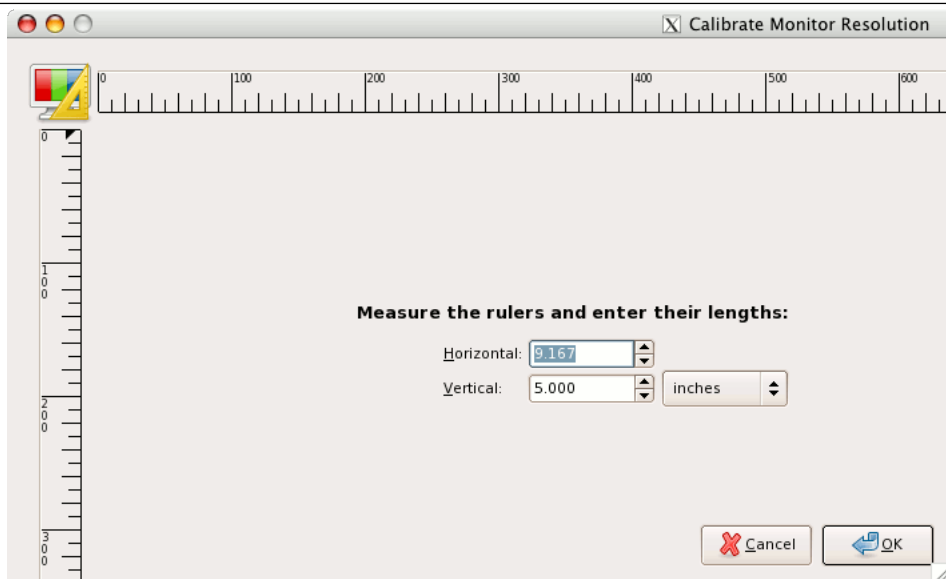
This page lets you customize the way transparent parts of an image are represented, and lets you recalibrate the resolution of your monitor.

12.1.14.1 Options

Transparency

Transparency type By default, GIMP indicates transparency using a checkerboard pattern with mid-tone checks, but you can change this if you want, either to a different type of checkerboard, or to solid black, white, or gray.

Check size Here you can alter the size of the squares in the checkerboard pattern used to indicate transparency.

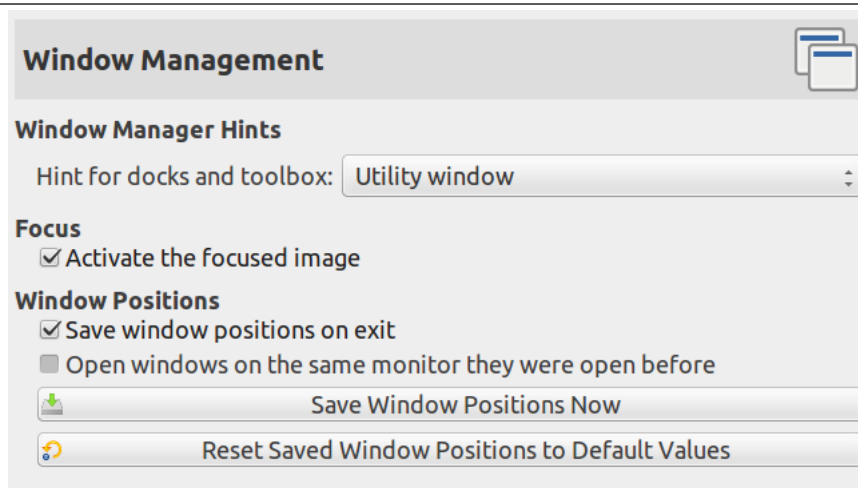
Figure 12.16 The Calibration dialog

Monitor Resolution Monitor Resolution is the ratio of pixels, horizontally and vertically, to inches. You have three ways to proceed here:

- Get Resolution from windowing system. (easiest, probably inaccurate).
- Set Manually
- Push the Calibrate Button.

The Calibrate Dialog My monitor was impressively off when I tried the Calibrate Dialog. The “Calibrate Game” is fun to play. You will need a soft ruler.

12.1.15 Window Management

Figure 12.17 Window Management Preferences

This page lets you customize the way windows are handled in GIMP. You should note that GIMP does not manipulate windows directly, instead it sends requests to the window manager (i. e., to Windows if you are running in Windows; to Metacity if you are running in a standard Gnome setup in Linux; etc). Because there are many window managers, and not all of them are well behaved, it cannot be guaranteed that the functions described here will actually work as described. However, if you are using a modern, standards-compliant window manager, they ought to.

12.1.15.1 Options

Window Manager Hints

Window type hints for the toolbox and the docks The choices you make here determine how the Toolbox, and the docks that hold dialogs, will be treated. You have three possibilities for them:

- If you choose Normal Window, they will be treated like any other windows.
- If you choose Utility Window, the reduce button in the title bar is absent and the docks will remain permanently on your screen.

Figure 12.18 Utility window title bar



- If you choose Keep above, they will be kept in front of every other window at all times.

Note that changes you make here will not take effect until the next time you start GIMP.

Focus

Activate the focused image Normally, when you focus an image window (usually indicated by a change in the color of the frame), it becomes the “active image” for GIMP, and therefore the target for any image-related actions you perform. Some people, though, prefer to set up their window managers such that any window entered by the pointer is automatically focused. If you do this, you may find that it is inconvenient for focused images to automatically become active, and may be happier if you uncheck this option.

Window Positions

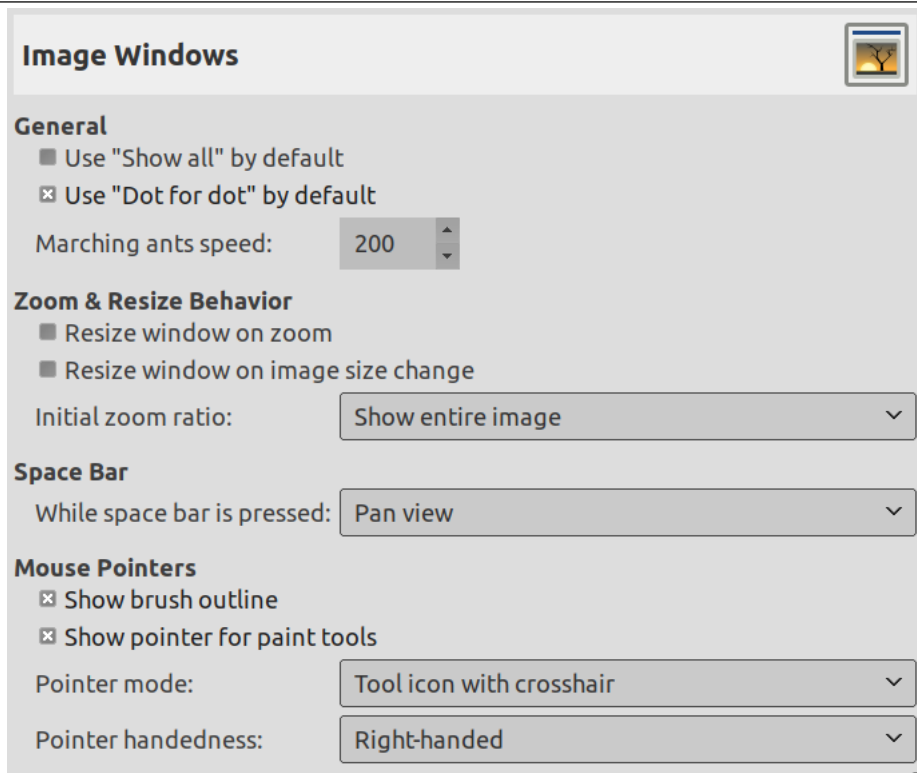
Save window positions on exit If this option is checked, the next time you start GIMP, you will see the same set of dialog windows, in the same positions they occupied when you last exited.

Save Window Positions Now This button is only useful if “Save window positions on exit” is unchecked. It allows you to set up your windows the way you like, click the button, and then have them come up in that arrangement each time you start GIMP.

Reset Saved Window Positions to Default Values If you decide that you are unhappy with the arrangement of windows you have saved, and would rather go back to the default arrangement than spend time moving them around, you can do so by pressing this button.

12.1.16 Image Windows

Figure 12.19 General Image Window Preference



This page lets you customize several aspects of the behaviour of image windows.

12.1.16.1 Options

General

Use “Show all” by default Please refer to Section 16.5.3 to understand this option.

Use “Dot for dot” by default Using “Dot for dot” means that at 1:1 zoom, each pixel is the image is scaled to one pixel on the display. If “Dot for dot” is not used, then the displayed image size is determined by the X and Y resolution of the image. See the [Scale Image](#) section for more information.

Marching ants speed When you create a selection, the edge of it is shown as a dashed line with dashes that appear to move, marching slowly along the boundary: they are jokingly called “marching ants”. The smaller the value entered here, the faster the ants march (and consequently the more distracting they are!).

Zoom and Resize Behavior

Resize window on zoom If this option is checked, then each time you zoom the image, the image window will automatically resize to follow it. Otherwise, the image window will maintain the same size when you zoom the image.

Resize window on image size change If this option is checked, then each time change the size of the image, by cropping or resizing it, the image window will automatically resize to follow. Otherwise, the image window will maintain the same size.

Initial zoom ratio You can choose either to have images, when they are first opened, scaled so that the whole image fits comfortably on your display, or else shown at 1:1 zoom. If you choose the second option, and the image is too large to fit on your display, then the image window will show only part of it (but you will be able to scroll to other parts).

Space bar

While space bar is pressed

- Pan view (default) or
- Toggle to Move Tool
- No action

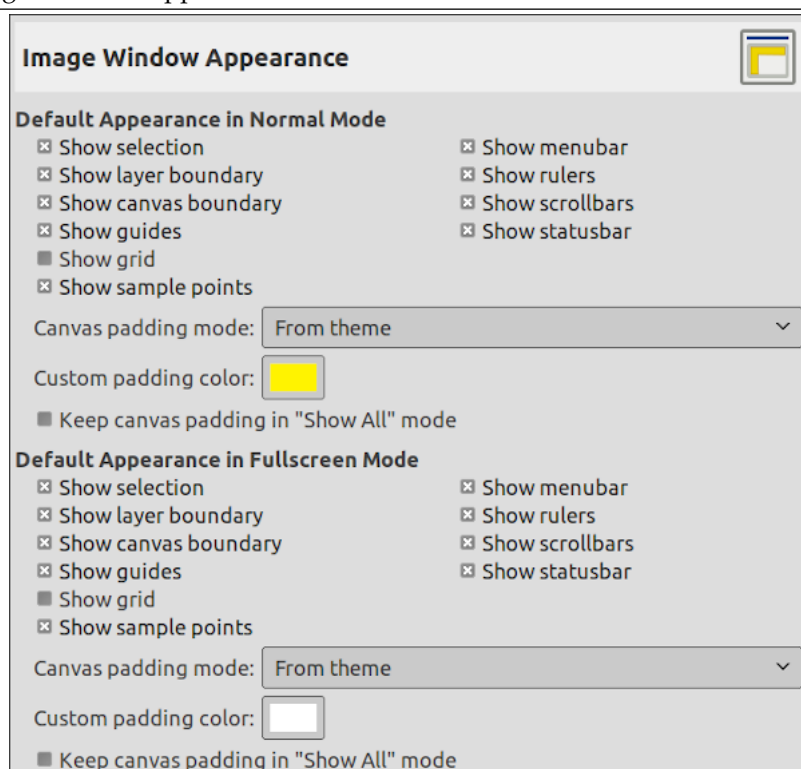
Mouse Cursors

Show brush outline If this option is checked, then when you use a paint tool, the outline of the brush will be shown on the image as you move the pointer around. On slow systems, if the brush is very large, this could occasionally cause some lag in GIMP's ability to follow your movements: if so, switching this off might help. Otherwise, you will probably find it quite useful.

Show paint tool cursor If this is checked, a cursor will be shown. This is in addition to the brush outline, if the brush outline is being shown. The type of cursor is determined by the next option.

Cursor mode This option has no effect unless Show paint tool cursor is checked. If it is, you have three choices: Tool icon, which causes a small iconic representation of the currently active tool to be shown beside the cursor; Tool icon with crosshair, which shows the icon as well as a crosshair indicating the center of the cursor; or Crosshair only.

Cursor rendering If you choose "Fancy" here, the cursor is drawn in grayscale. If you choose "Black and White", it is drawn in a simpler way that may speed things up a little bit if you have speed issues.

12.1.17 Image Window Appearance**Figure 12.20** Image Window Appearance Defaults

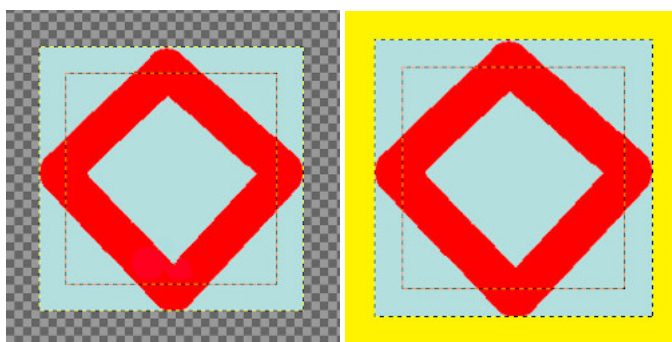
This page lets you customize the default appearance of image windows, for normal mode and for fullscreen mode. All of the settings here can be altered on an image-specific basis using entries in the View menu.

The only parts that may need further explanation are the ones related to padding. "Padding" is the color shown around the edges of the image. You can choose among four colors for the padding color: to use the color specified by the current theme; to use the light or dark colors specified for checks, such

as represent transparent parts of the image; or to use a custom color, which can be set using the color button for “Custom padding color”.

Keep canvas padding in Show All mode: in this mode (Section 16.5.3), you can see pixels spilling off the canvas boundary. When this option is not checked, the canvas is filled with a checkerboard pattern, even if you have selected a custom padding color. When the option is checked, the canvas has the custom padding color.

Figure 12.21 Example

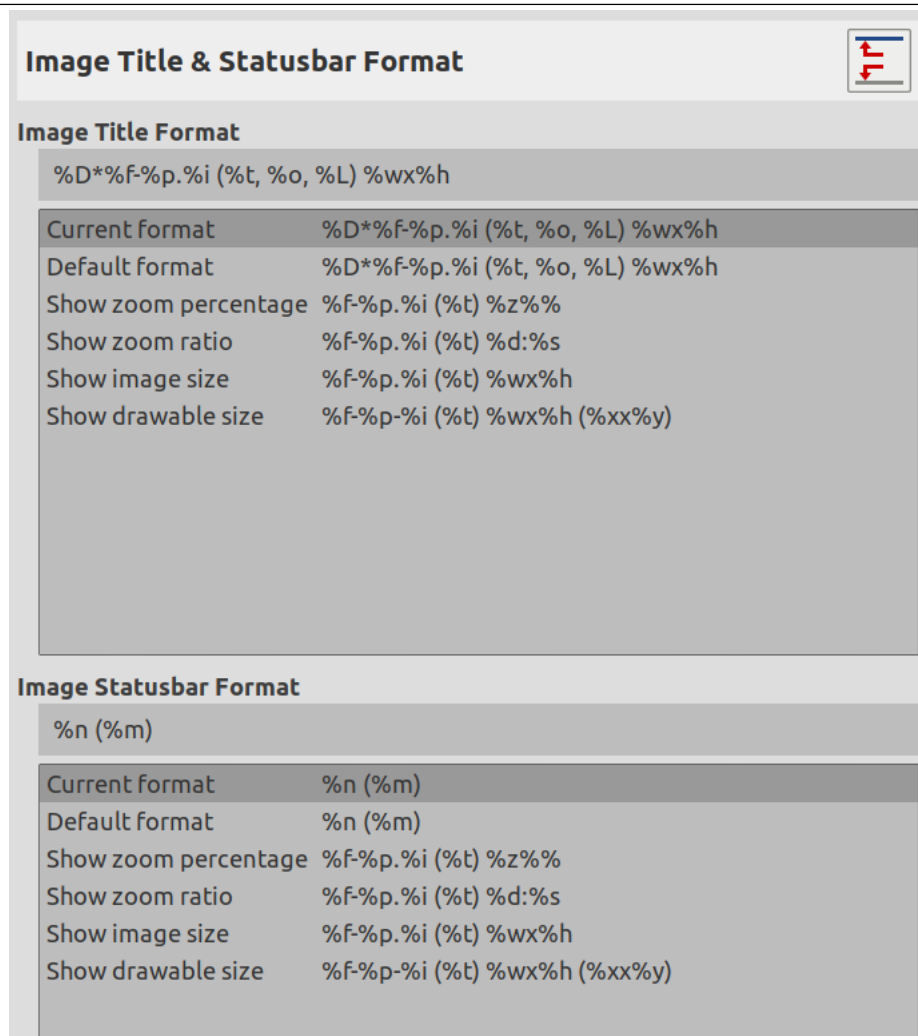


(a) Padding color is yellow. “Keep canvas padding” is not checked.

(b) Padding color is yellow. “Keep canvas padding” is checked.

12.1.18 Image Window Title and Statusbar

Figure 12.22 Image Window Title and Statusbar formats



This page lets you customize the text that appears in two places: the title bar of an image, and the status bar. The title bar should appear above the image; however this depends on cooperation from the window manager, so it is not guaranteed to work in all cases. The statusbar appears underneath the image, on the right side. See the [Image Window](#) section for more information.

12.1.18.1 Choosing a Format

You can choose among several predesigned formats, or you can create one of your own, by writing a *format string* in the entry area. Here is how to understand a format string: anything you type is shown exactly as you type it, with the exception of *variables*, whose names all begin with “%”. Here is a list of the variables you can use:

Variable: %f, Meaning: Bare filename of the image, or “Untitled”

Variable: %F, Meaning: Full path to file, or “Untitled”

Variable: %p, Meaning: Image id number (this is unique)

Variable: %i, Meaning: View number, if an image has more than one display

Variable: %t, Meaning: Image type (RGB, grayscale, indexed)

Variable: %z, Meaning: Zoom factor as a percentage

Variable: %s, Meaning: Source scale factor (zoom level = %d/%s)

Variable: %d, Meaning: Destination scale factor (zoom level = %d/%s)

Variable: %Dx, Meaning: Expands to x if the image is dirty, nothing otherwise

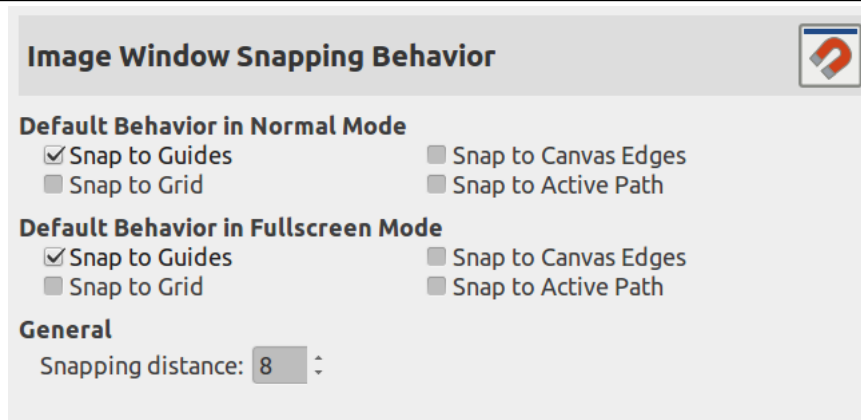
Variable: %Cx, Meaning: Expands to x if the image is clean, nothing otherwise

Variable: %l, Meaning: The number of layers

Variable: %L, Meaning: Number of layers (long form)
 Variable: %m, Meaning: Memory used by the image
 Variable: %n, Meaning: Name of the active layer/channel
 Variable: %P, Meaning: id of the active layer/channel
 Variable: %w, Meaning: Image width in pixels
 Variable: %W, Meaning: Image width in real-world units
 Variable: %h, Meaning: Image height in pixels
 Variable: %H, Meaning: Image height in real-world units
 Variable: %u, Meaning: Unit symbol (eg. px for Pixel)
 Variable: %U, Meaning: Unit abbreviation
 Variable: %%, Meaning: A literal “%” symbol

12.1.19 Image Window Snapping Behavior

Figure 12.23 Image Window Snapping Behavior

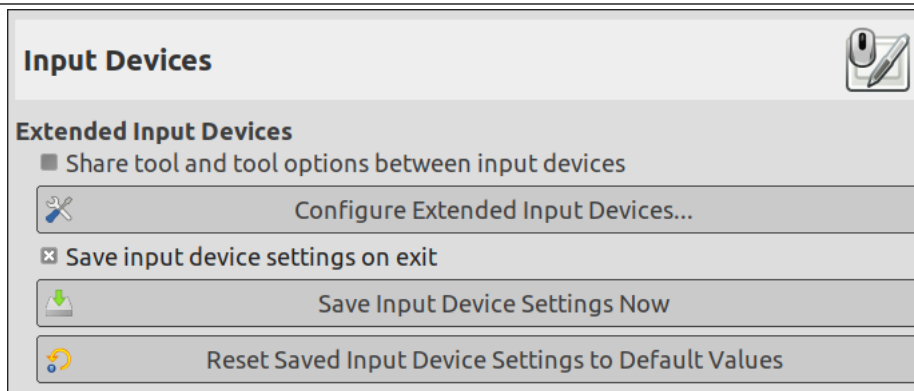


This page allows you to customize snapping in the image. Only Snap to Guides is activated by default. You can also check Snap to Grid, Snap to Canvas Edges and Snap to Active Path, in normal mode and fullscreen mode.

Snapping distance is the activation distance of snapping, in pixels. Default value is 8 pixels (1-255).

12.1.20 Input Devices

Figure 12.24 Input devices preferences

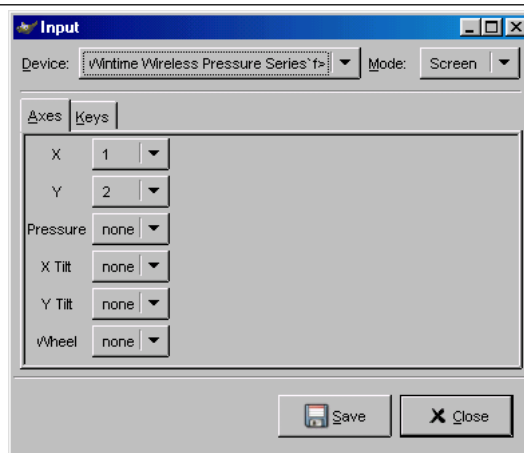


Extended Input Devices

Share tool and tool options between input devices When enabled, the same tool and tool options will be used for all input devices. No tool switching will occur when the input device changes.

Configure Extended Input Devices This large button allows you to set the devices associated with your computer: tablet, MIDI keyboard... If you have a tablet, you will see a dialog like this:

Figure 12.25 Preferences for a tablet



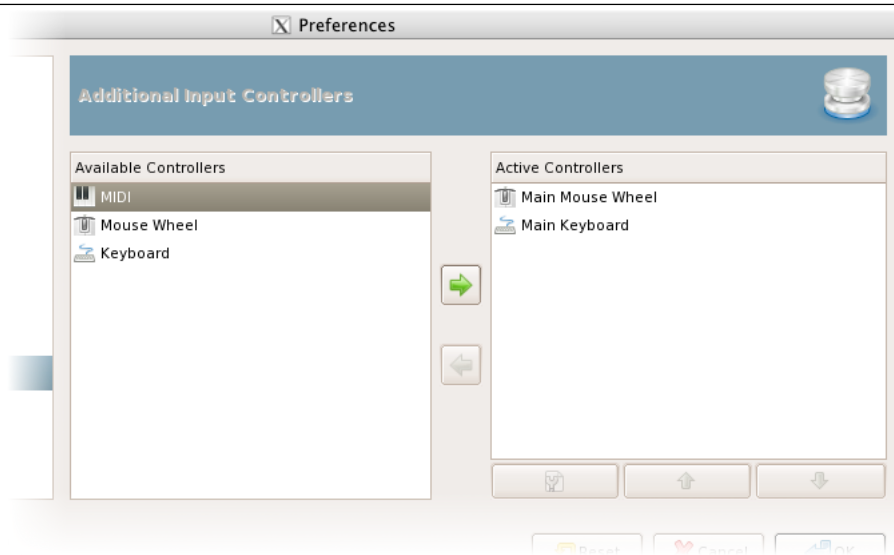
Save input device settings on exit When you check this box, GIMP remembers the tool, color, pattern, and brush you were using the last time you quit.

Save Input Device Settings Now Self explanatory.

Reset Saved Input Device Settings to Default Values Delete your settings and restore default settings.

12.1.21 Input Controllers

Figure 12.26 Input controllers preferences



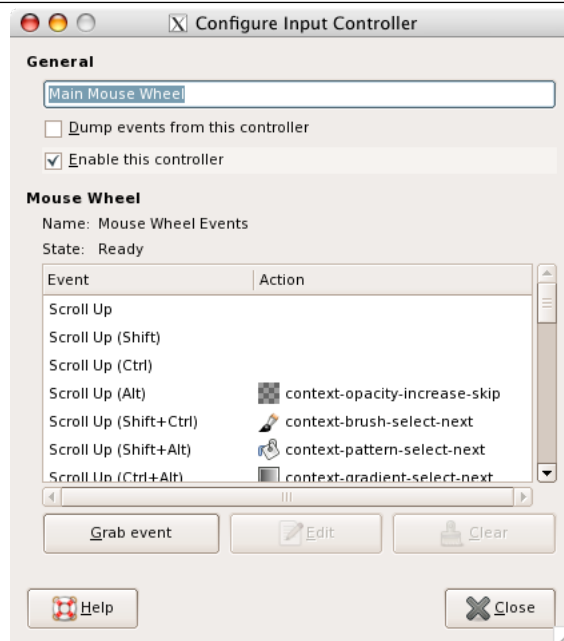
This dialog has two lists of additional input controllers: Available Controllers on the left, Active Controllers on the right. It is used to enable or disable an input device and configure it.

A click on an item will highlight it and you can move the controller from one list to the other by clicking on the respective arrow key. When you try to move a controller from the list of active controllers to the available controllers, a dialog pops up and you will have the choice of removing the controller or just disabling it.

When you double click on a (typically active) controller or alternatively click on the Edit button at the bottom of the list, you can configure this controller in a dialog window:

Main Mouse Wheel

Figure 12.27 Main Mouse Wheel



General

Dump events from this controller This option must be checked if you want a print on the stdout of the events generated by the enabled controllers. If you want to see those event you should start GIMP from a terminal or making it to print the stdout to file by the shell redirection. The main use of this option is for debug.

Enable this controller This option must be checked if you want to add a new actions to the mouse wheel.

Mouse Wheel Events In this window with scroll bars you have: on the left, the possible events concerning the mouse wheel, more or less associated with control keys; on the right, the action assigned to the event when it will happen. You have also two buttons, one to Edit the selected event, the other to Cancel the action of the selected event.

Some actions are assigned to events yet. They seem to be examples, as they are not functional.

Select the action allocated to the event After selecting an event, if you click on the Edit button, you open the following dialog:

Figure 12.28 Select Controller Event Action

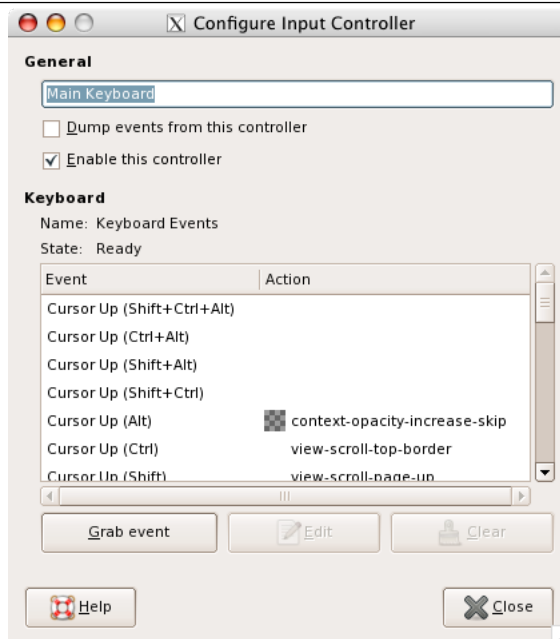


If an action exists yet for this event, the window will open on this action. Else, the window will display the sections that order actions. Click on an action to select it.

Main Keyboard

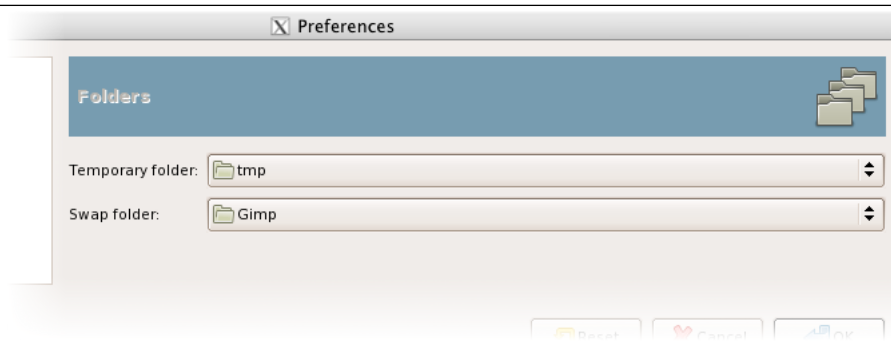
You can use this dialog in the same way as that of the mouse wheel. Events are related to the arrow keys of the keyboard, combined or not with control keys.

Figure 12.29 Main Keyboard



Note

You will find an example of these notions in [Creating a variable size brush](#).

12.1.22 Folders**Figure 12.30** Basic Folder Preferences

This page allows you to set the locations for two important folders used by GIMP for temporary files. The pages below it allow you to customize the locations searched for resources such as brushes etc.; see [Data Folders](#) for a description that applies to them. You can change the folders here by editing the entries, or by pressing the buttons on the right to bring up a file chooser window.

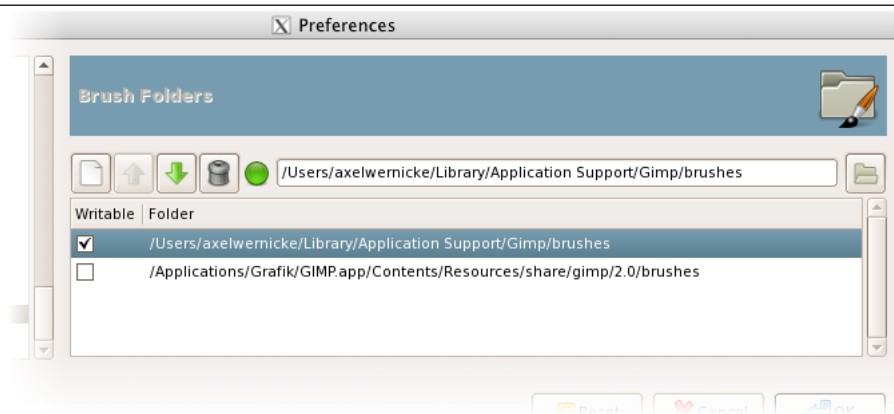
Folders

Temp folder This folder is used for temporary files: files created for temporary storage of working data, and then deleted within the same GIMP session. It does not require a lot of space or high performance. By default, a subdirectory called `tmp` in your personal GIMP directory is used, but if that disk is very cramped for space, or has serious performance issues, you can change it to a different directory. The directory must exist and be writable by you, or bad things will happen.

Swap folder This is the folder used as a “memory bank” when the total size of images and data open in GIMP exceeds the available RAM. If you work with very large images, or images with many layers, or have many images open at once, GIMP can potentially require hundreds of megabytes of swap space, so available disk space and performance are definitely things to think about for this folder. By default, it is set to your personal GIMP directory, but if you have another disk with more free space, or substantially better performance, you may see a significant benefit from moving your swap folder there. The directory must exist and be writable by you.

12.1.23 Data Folders

Figure 12.31 Preferences: Brush Folders




GIMP uses several types of resources – such as brushes, patterns, gradients, etc. – for which a basic set are supplied by GIMP when it is installed, and others can be created or downloaded by the user. For each such resource type, there is a Preference page that allows you to specify the *search path*: the set of directories from which items of the type in question are automatically loaded when GIMP starts. These pages all look very much the same: the page for brushes is shown to the right as an example.

By default, the search path includes two folders: a *system* folder, where items installed along with GIMP are placed, and a *personal* folder, inside your personal GIMP directory, where items added by you should be placed. The system folder should not be marked as writable, and you should not try to alter its contents. The personal folder must be marked as writable or it is useless, because there is nothing inside it except what you put there.

You can customize the search path with the buttons at the top of the dialog.

Options

Select a Folder If you click on one of the folders in the list, it is selected for whatever action comes next.

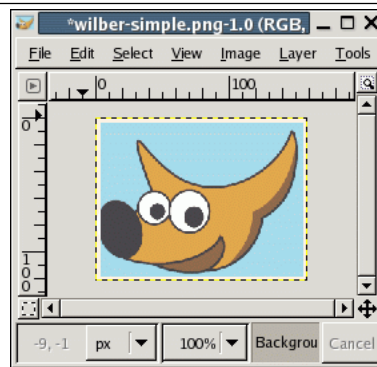
Add/Replace Folder If you type the name of a folder in the entry space, or navigate to it using the file chooser button  on the right, and then click the left button, this will replace the selected folder with the one you have specified. If nothing in the list is selected, the folder you specify will be added to the list. If the light-symbol to the left of the text entry area is red instead of green, it means that the folder you have specified does not exist. GIMP will not create it for you, so you should do this immediately.

Move Up/Down If you click on the up-arrow or down-arrow buttons, the selected folder will be changed to the following or preceding one in the list. Since the folders are read in order, using those buttons change the loading precedence of the items located in those folders.

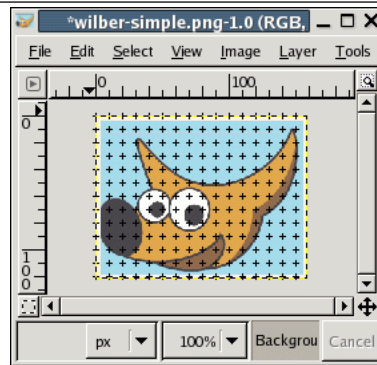
Delete Folder If you click the trash-can button, the selected folder will be deleted from the list. (The folder itself is not affected; it is merely removed from the search path.) Deleting the system folder is probably a bad idea, but nothing prevents you from doing it.

12.2 Grids and Guides

You will probably have it happen many times that you need to place something in an image very precisely, and find that it is not easy to do using a mouse. Often you can get better results by using the arrow keys on the keyboard (which move the affected object one pixel at a time, or 25 pixels if you hold down the **Shift** key), but GIMP also provides you with two other aids to make positioning easier: grids and guides.

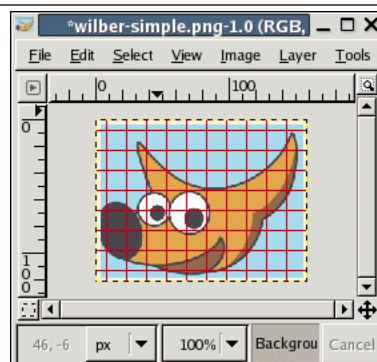
Figure 12.32 Image used for examples below

12.2.1 The Image Grid

Figure 12.33 Image with default grid

Each image has a grid. It is always present, but by default it is not visible until you activate it by toggling **View** → **Show Grid** in the image menu. If you want grids to be present more often than not, you can change the default behavior by checking “Show grid” in the **Image Window Appearance** page of the Preferences dialog. (Note that there are separate settings for Normal Mode and Fullscreen Mode.)

The default grid appearance, set up when you install GIMP, consists of plus-shaped black crosshairs at the grid line intersections, with grid lines spaced every 10 pixels both vertically and horizontally. You can customize the default grid using the **Default Image Grid** page of the Preferences dialog. If you only want to change the grid appearance for the current image, you can do so by choosing **Image** → **Configure Grid** from the image menu: this brings up the **Configure Grid** dialog.

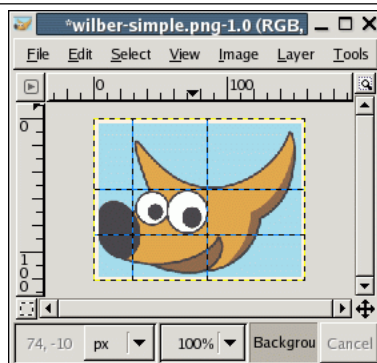
Figure 12.34 A different grid style

Not only can a grid be helpful for judging distances and spatial relationships, it can also permit you to align things exactly with the grid, if you toggle **View** → **Snap to Grid** in the image menu: this causes the pointer to “warp” perfectly to any grid line located within a certain distance. You can customize the

snap distance threshold by setting “Snap distance” in the **Tool Options** page of the Preferences dialog, but most people seem to be happy with the default value of 8 pixels. (Note that it is perfectly possible to snap to the grid even if the grid is not visible. It isn’t easy to imagine why you might want to do this, though.)

12.2.2 Guides

Figure 12.35 Image with four guides



In addition to the image grid, GIMP also gives you a more flexible type of positioning aid: *guides*. These are horizontal or vertical lines you can temporarily display on an image while you are working on it.

To create a guide, simply click on one of the rulers in the image window and pull out a guide, while holding the mouse Left Button pressed. The guide is then displayed as a blue, dashed line, which follows the pointer. As soon as you create a guide, the “Move” tool is activated and the mouse pointer changes to the Move icon.

You can also create a guide with the **New Guide** command, which allows you to precisely place the guide on the image, the **New Guide (by Percent)** command, or the **New Guides from Selection** command.

You can create as many guides as you like, positioned wherever you like. To *move a guide* after you have created it, activate the Move tool in the Toolbox (or press the **M** key), you can then click and drag a guide; click-and-drag the intersection of two guides to move them together. To *delete a guide*, simply drag it outside the image. Holding down the **Shift** key, you can move everything but a guide, using the guides as an effective alignment aid.

The behavior of the guides depends upon the Move (Affect) mode of the “Move” tool. When *Layer* mode is selected, the mouse pointer turns into a small hand as soon as it gets close to a guide. Then the guide is activated and it turns red, and you can move the guide or delete it by moving it back into the ruler. If *Selection* mode is selected, you can position a guide, but you cannot move it after that.

As with the grid, you can cause the pointer to snap to nearby guides, by toggling **View** → **Snap to Guides** in the image menu. If you have a number of guides and they are making it difficult for you to judge the image properly, you can hide them by toggling **View** → **Show Guides**. It is suggested that you only do this momentarily, otherwise you may get confused the next time you try to create a guide and don’t see anything happening.

If it makes things easier for you, you can change the default behavior for guides in the **Image Windows Appearance** page of the Preferences dialog. Disabling **Show guides** is probably a bad idea, though, for the reason just given.

You can remove the guides with the **Image** → **Guides** → **Remove all Guides** command.

Note



Another use for guides: the **Slice Using Guides** plugin can use guides to slice an image into a set of sub-images.

12.3 Rendering a Grid

How can you create a grid that is actually part of the image? You can't do this using the image grid: that is only an aid, and is only visible on the monitor or in a screenshot. You can, however, use the **Grid** plugin to render a grid very similar to the image grid. (Actually, the plugin has substantially more options.)

See also **Grid and Guides**.

12.4 How to Set Your Tile Cache

During the data processing and manipulation of pictures, GIMP becomes in the need of much main memory. The more is available the better is. GIMP uses the operating system memory available resources as effectively as possible, striving to maintain the work on the pictures fast and comfortable for the user. That Data memory, during the treatment, is organized in buffered blocks of graphic data, which could exist in two different forms of data memory: in the slow not removable disk or in the fast main RAM memory. GIMP uses preferably the RAM, and when it runs short of this memory, it uses the hard disk for the remaining data. These chunks of graphic data are commonly referred to as "tiles" and the entire system is called "tile cache".

A low value for tile cache means that GIMP sends data to the disk very quickly, not making real use of the available RAM, and making the disks work for no real reason. Too high a value for tile cache, and other applications start to have less system resources, forcing them to use swap space, which also makes the disks work too hard; some of them may even terminate or start to malfunction due lack of RAM.

How do you choose a number for the Tile Cache size? Here are some tips to help you decide what value to use, as well as a few tricks:

- The easiest method is to just forget about this and hope the default works. This was a usable method when computers had little RAM, and most people just tried to make small images with GIMP while running one or two other applications at the same time. If you want something easy and only use GIMP to make screenshots and logos, this is probably the best solution.
- If you have a modern computer with plenty of memory—say, 512 MB or more—setting the Tile Cache to half of your RAM will probably give good performance for GIMP in most situations without depriving other applications. Probably even 3/4 of your RAM would be fine.
- Ask someone to do it for you, which in the case of a computer serving multiple users at the same time can be a good idea: that way the administrator and other users do not get mad at you for abusing the machine, nor do you get a badly underperforming GIMP. If it is your machine and only serves a single user at a given time, this could mean money, or drinks, as price for the service.
- Start changing the value a bit each time and check that it goes faster and faster with each increase, but the system does not complain about lack of memory. Be forewarned that sometimes lack of memory shows up suddenly with some applications being killed to make space for the others.
- Do some simple math and calculate a viable value. Maybe you will have to tune it later, but maybe you have to tune it anyway with the other previous methods. At least you know what is happening and can get the best from your computer.

Let's suppose you prefer the last option, and want to get a good value to start with. First, you need to get some data about your computer. This data is the amount of RAM installed in your system, the operating system's swap space available, and a general idea about the speed of the disks that store the operating system's swap and the directory used for GIMP's swap. You do not need to do disk tests, nor check the RPM of the disks, the thing is to see which one seems clearly faster or slower, or whether all are similar. You can change GIMP's swap directory in the Folders page of the Preferences dialog.

The next thing to do is to see how much resources you require for other apps you want to run at the same time than GIMP. So start all your tools and do some work with them, except GIMP of course, and check the usage. You can use applications like `free` or `top`, depending in what OS and what environment you use. The numbers you want is the memory left, including file cache. Modern Unix keeps a very small area free, in order to be able to keep large file and buffer caches. Linux's `free` command does the maths for you: check the column that says "free", and the line "-/+ buffers/cache". Note down also the free swap.

Now time for decisions and a bit of simple math. Basically the concept is to decide if you want to base all Tile Cache in RAM, or RAM plus operating system swap:

1. Do you change applications a lot? Or keep working in GIMP for a long time? If you spend a lot of time in GIMP, you can consider free RAM plus free swap as available; if not, you need to go to the following steps. (If you're feeling unsure about it, check the following steps.) If you are sure you switch apps every few minutes, only count the free RAM and just go to the final decision; no more things to check.
2. Does the operating system swap live in the same physical disk as GIMP swap? If so, add RAM and swap. Otherwise go to the next step.
3. Is the disk that holds the OS swap faster or the same speed as the disk that holds the GIMP swap? If slower, take only the free RAM; if faster or similar, add free RAM and swap.
4. You now have a number, be it just the free RAM or the free RAM plus the free OS swap. Reduce it a bit, to be on the safe side, and that is the Tile Cache you could use as a good start.

As you can see, all is about checking the free resources, and decide if the OS swap is worth using or will cause more problems than help.

There are some reasons you want to adjust this value, though. The basic one is changes in your computer usage pattern, or changing hardware. That could mean your assumptions about how you use your computer, or the speed of it, are no longer valid. That would require a reevaluation of the previous steps, which can drive you to a similar value or a completely new value.

Another reason to change the value is because it seems that GIMP runs too slowly, while changing to other applications is fast: this means that GIMP could use more memory without impairing the other applications. On the other hand, if you get complaints from other applications about not having enough memory, then it may benefit you to not let GIMP hog so much of it.

If you decided to use only RAM and GIMP runs slowly, you could try increasing the value a bit, but never to use also all the free swap. If the case is the contrary, using both RAM and swap, and you have problems about lack of resources, then you should decrease the amount of RAM available to GIMP.

Another trick is to put the Swap Dir on a very fast disk, or on a different disk than the one where most of your files reside. Spreading the operating system swap file over multiple disks is also a good way to speed things up, in general. And of course, you might have to buy more RAM or stop using lots of programs at the same time: you can not expect to edit a poster on a computer with 16MB and be fast.

You can also check what memory requirements your images have. The larger the images, and the number of undoes, the more resources you need. This is another way to choose a number, but it is only good if you always work with the same kind of images, and thus the real requirements do not vary. It is also helpful to know if you will require more RAM and/or disk space.

12.5 Creating Shortcuts to Menu Functions

Many functions which are accessible via the image menu have a default keyboard shortcut. You may want to create a new shortcut for a command that you use a lot and doesn't have one or, more rarely, edit an existing shortcut. There are two methods for doing this.

Using dynamic keyboard shortcuts

1. First, you have to activate this capability by checking the Use dynamic keyboard shortcuts option in the Interface item of the **Preferences** menu. This option is usually not checked, to prevent accidental key presses from creating an unwanted shortcut.
2. While you're doing that, also check the Save keyboard shortcuts on exit option so that your shortcut will be saved.
3. To create a keyboard shortcut, simply place the mouse pointer on a command in the menu: it will then be highlighted. Be careful that the mouse pointer doesn't move and type a sequence of three keys, keeping the keys pressed. You will see this sequence appear on the right of the command.
4. It is best to use the Ctrl-Alt-Key sequence for your custom shortcuts.

Figure 12.36 Configure Keyboard Shortcuts

Using the Keyboard Shortcut Editor

1. You get to this Editor by clicking on Configure keyboard shortcuts in the “Interface” item of the **Preferences** menu.
2. As shown in this dialog, you can select the command you want to create a shortcut for, in the “Action” area. Then you type your key sequence as above. In principle, the Space bar should clear a shortcut. (In practice, it clears it, but doesn’t delete it.)
3. This shortcut editor also allows you to *control the tool parameter settings* with the keyboard. At the top of this dialog, you can find a Context menu that takes you to the tool parameters. To make your work easier, tool types are marked with small icons.

Note

Custom Keyboard shortcuts are stored in one of Gimp’s hidden directory (`/home/[username]/.config/GIMP/2.10/menurc`) under Linux. Under Windows, local and global location are, respectively:

- `C:\Documents and Settings\[Username]\AppData\Roaming\GIMP\2.10\menurc`
- `C:\Program Files\GIMP 2\etc\gimp\2.0\menurc`



This location may change if GIMP is installed after having already installed Git Bash or Cygwin. In this case, they will appear in `C:\Program Files\Git\.gimp-[version]\menurc`.

“menu.rc” is a simple text file that you can transport from one computer to another.

12.6 Customize Splash-Screen

When you start GIMP, you see the *splash-screen* displaying short status messages while the program is loading all its components.

Of course, you can customize the splash-screen: Create a `splashes` directory in your personal GIMP folder (`/home/user_name/.config/GIMP/2.10/` on Linux, `C:\Documents and Settings\user_name\AppData\Roaming\GIMP\2.10\` on Windows, `/Users/user_name/Library/Application Support/GIMP/2.10/` on MacOS).

Copy your image(s) into this `splashes` directory. On start, GIMP will read this directory and choose one of the images at random.

Tip



Make sure that your images aren't too small.

Chapter 13

Scripting

13.1 Plugins

13.1.1 Introduction

One of the nicest things about GIMP is how easily its functionality can be extended, by using plugins. GIMP plugins are external programs that run under the control of the main GIMP application and interact with it very closely. Plugins can manipulate images in almost any way that users can. Their advantage is that it is much easier to add a capability to GIMP by writing a small plugin than by modifying the huge mass of complex code that makes up the GIMP core. Many valuable plugins have C source code that only comes to 100-200 lines or so.

Several dozen plugins are included in the main GIMP distribution, and installed automatically along with GIMP. Most of them can be accessed through the Filters menu (in fact, everything in that menu is a plugin), but a number are located in other menus. In many cases you can use one without ever realizing that it is a plugin: for example, the "Normalize" function for automatic color correction is actually a plugin, although there is nothing about the way it works that would tell you this.

Anybody in the world can write a GIMP plugin and make it available over the web, either via the Registry or a personal web site, and many very valuable plugins can be obtained in this way some are described elsewhere in the User's Manual. With this freedom from constraint comes a certain degree of risk, though: the fact that anybody can do it means that there is no effective quality control. The plugins distributed with GIMP have all been tested and tuned by the developers, but many that you can download were just hacked together in a few hours and then tossed to the winds. Some plugin creators just don't care about robustness, and even for those who do, their ability to test on a variety of systems in a variety of situations is often quite limited. Basically, when you download a plugin, you are getting something for free, and sometimes you get exactly what you pay for. This is not said in an attempt to discourage you, just to make sure you understand reality.

Warning



Plugins, being full-fledged executable programs, can do any of the things that any other program can do, including install back-doors on your system or otherwise compromise its security. Don't install a plugin unless it comes from a trusted source.

Caution



Plugins have been a feature of GIMP for many versions. However, plugins written for one version of GIMP can hardly ever be used successfully with other versions. They need to be ported: sometimes this is easy, sometimes not. Many plugins are already available in several versions. Bottom line: before trying to install a plugin, make sure that it is written for your version of GIMP.

13.1.2 Using Plugins

For the most part you can use a plugin like any other GIMP tool, without needing to be aware that it is a plugin. But there are a few things about plugins that are useful to understand.

One is that plugins are generally not as robust as the GIMP core. When GIMP crashes, it is considered a very serious thing: it can cost the user a lot of trouble and headache. When a plugin crashes, the consequences are usually not so serious. In most cases you can just continue working without worrying about it.

Note



Because plugins are separate programs, they communicate with the GIMP core in a special way: The GIMP developers call it “talking over a wire”. When a plugin crashes, the communication breaks down, and you will see an error message about a “wire read error”.

Tip



When a plugin crashes, GIMP gives you a very ominous-looking message telling you that the plugin may have left GIMP in a corrupted state, and you should consider saving your images and exiting. Strictly speaking, this is quite correct, because plugins have the power to alter almost anything in GIMP, but for practical purposes, experience has shown that corruption is actually quite rare, and many users just continue working and don't worry about it. Our advice is that you simply think about how much trouble it would cause you if something went wrong, and weigh it against the odds.

Because of the way plugins communicate with GIMP, they do not have any mechanism for being informed about changes you make to an image after the plugin has been started. If you start a plugin, and then alter the image using some other tool, the plugin will often crash, and when it doesn't will usually give a bogus result. You should avoid running more than one plugin at a time on an image, and avoid doing anything to the image until the plugin has finished working on it. If you ignore this advice, not only will you probably screw up the image, you will probably screw up the undo system as well, so that you won't even be able to recover from your foolishness.

13.1.3 Installing New Plugins

The plugins that are distributed with GIMP don't require any special installation. Plugins that you download yourself do. There are several scenarios, depending on what OS you are using and how the plugin is structured. In Linux it is usually pretty easy to install a new plugin; in Windows, it is either easy or very hard. In any case, the two are best considered separately.

13.1.3.1 Linux / Unix-like systems

Most plugins fall into two categories: small ones whose source code is distributed as a single `.c` file, and larger ones whose source code is distributed as a directory containing multiple files including a `Makefile`.

For a simple one-file plugin, call it `borker.c`, installing it is just a matter of running the command **`gimptool-2.0 --install borker.c`**. This command compiles the plugin and installs it in your personal plugin directory, `~/gimp-2.4/plugins` unless you have changed it. This will cause it to be loaded automatically the next time you start GIMP. You don't need to be root to do these things; in fact, you shouldn't be. If the plugin fails to compile, well, be creative.

Once you have installed the plugin, how do you activate it? The menu path is determined by the plugin itself, so to answer this you need to either look at the documentation for the plugin (if there is any), or launch the Plugin Description dialog (from Xtns/Plugins Details) search the plug-in by its name and look of the Tree view tab. If you still don't find, finally explore the menus or look at the source code in the Register section -- whichever is easiest.

For more complex plugins, organized as a directory with multiple files, there ought to be a file inside called either `INSTALL` or `README`, with instructions. If not, the best advice is to toss the plugin in the trash and spend your time on something else: any code written with so little concern for the user is likely to be frustrating in myriad ways.

Some plugins (specifically those based on the GIMP Plugin Template) are designed to be installed in the main system GIMP directory, rather than your home directory. For these, you will need to be root to perform the final stage of installation (when issuing the **`make install`** command).

If you install in your personal plugin directory a plugin that has the same name as one in the system plugin directory, only one can be loaded, and it will be the one in your home directory. You will receive messages telling you this each time you start GIMP. This is probably a situation best avoided.

13.1.3.2 Windows

Windows is a much more problematic environment for building software than Linux. Every decent Linux distribution comes fully supplied with tools for compiling software, and they are all very similar in the way they work, but Windows does not come with such tools. It is possible to set up a good software-building environment in Windows, but it requires either a substantial amount of money or a substantial amount of effort and knowledge.

What this means in relation to GIMP plugins is the following: either you have an environment in which you can build software, or you don't. If you don't, then your best hope is to find a precompiled version of the plugin somewhere (or persuade somebody to compile it for you), in which case you simply need to put it into your personal plugin directory. If you do have an environment in which you can build software (which for present purposes means an environment in which you can build GIMP), then you no doubt already know quite a bit about these things, and just need to follow the Linux instructions.

13.1.3.3 Apple Mac OS X

How you install plugins on OS X mostly depends on how you installed GIMP itself. If you were one of the brave and installed GIMP through one of the package managers like `fink` [[FINK](#)] or `darwinports` [[DARWINPORTS](#)], the plugin installation works exactly the way it is described for the Linux platform already. The only difference is, that a couple of plugins might be even available in the repository of your package manager, so give it a try.

If you on the other hand are one of the Users that preferred to grab a prebuild GIMP package like `GIMP.app`, you most probably want to stick to that prebuild stuff. So you can try to get a prebuild version of the plugin of your dreams from the author of the plugin, but I'd not want to bet on this. Building your own binaries unfortunately involves installing GIMP through one of the package managers mentioned above.

13.1.4 Writing Plugins

If you want to learn how to write a plugin, you can find plenty of help at the GIMP Developers web site [[GIMP-DEV-PLUGIN](#)]. GIMP is a complex program, but the development team has made strenuous efforts to flatten the learning curve for plugin writing: there are good instructions and examples, and the main library that plugins use to interface with GIMP (called "libgimp") has a well-documented API.

Good programmers, learning by modifying existing plugins, are often able to accomplish interesting things after just a couple of days of work.

13.2 Using Script-Fu Scripts

13.2.1 Script-Fu?

Script-Fu is what the Windows world would call “macros” But Script-Fu is more powerful than that. Script-Fu is based on an interpreting language called Scheme, and works by using querying functions to the GIMP database. You can do all kinds of things with Script-Fu, but an ordinary GIMP user will probably use it for automating things that:

- You want to do frequently.
- Are really complicated to do, and hard to remember.

Remember that you can do a whole lot with Script-Fu. The scripts that come with GIMP can be quite useful, but they can also serve as models for learning Script-Fu, or at least as a framework and source of modification when you make your own script. Read the Script-Fu Tutorial in the next section if you want to learn more about how to make scripts.

We will describe some of the most useful scripts in this chapter, but we won’t cover them all. There are simply too many scripts. Some of the scripts are also very simple and you will probably not need any documentation to be able to use them.

Script-Fu (a dialect of Scheme) isn’t the only scripting language available for GIMP. But Script-Fu is the only scripting language that is installed by default.

13.2.2 Installing Script-Fus

One of the great things about Script-Fu is that you can share your script with all your GIMP friends. There are many scripts that come with GIMP by default, but there are also vast quantities of scripts that are available for download all around the Internet.

1. If you have downloaded a script, copy or move it to your scripts directory. It can be found in the **Preferences**: Folders → Scripts.
2. Do a refresh by using Filters → Script-Fu → Refresh Scripts from the image menubar. The script will now appear in one of your menus. If you don’t find it, look for it under the root file menu filters. If it doesn’t appear at all, something was wrong with the script (e.g. it contains syntax errors).

13.2.3 Do’s and Don’ts

A common error when you are dealing with Script-Fus is that you simply bring them up and press the OK button. When nothing happens, you probably think that the script is broken or buggy, but there is most likely nothing wrong with it.

13.2.4 Different Kinds Of Script-Fus

There are two kinds of Script-Fus:

Standalone Script-Fus You will find the standalone variants under File → Create → Type of Script in the image menubar (see the figure below).

Figure 13.1 Script-Fus by category

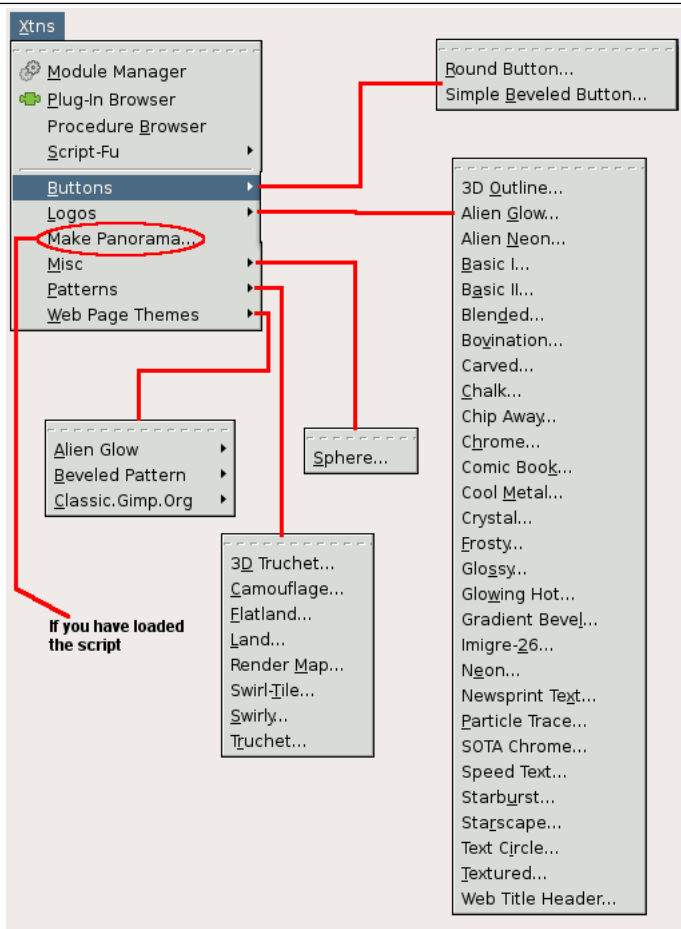
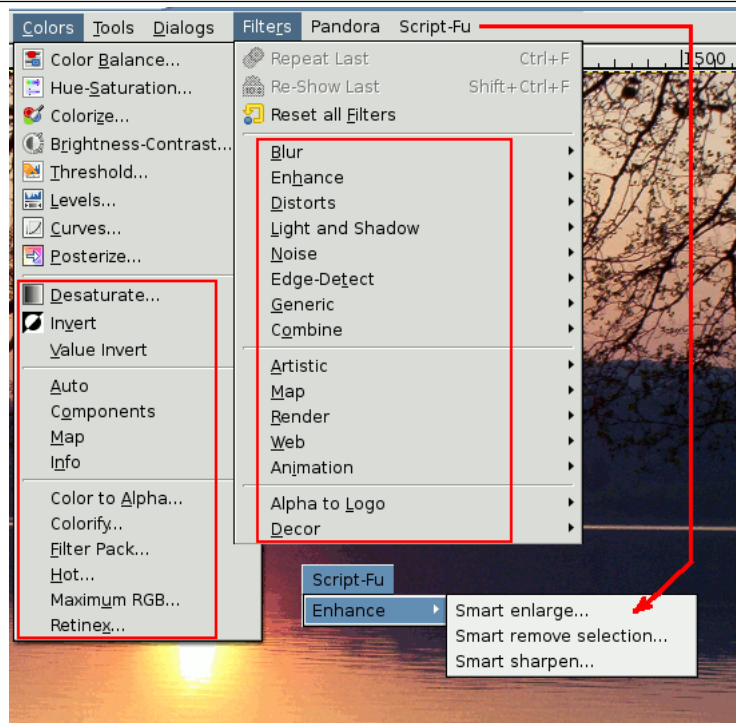


Image-dependent Script-Fus Menus have been reorganized. A new Colors-menu appears. It groups together all scripts that work on colors, for example tools that adjust hue, saturation, lightness..., filters...etc. Filters-menu and Script-Fu-menu are merged in one Filters-menu and it is organized according to new categories. Image-dependent Plug-ins and Script-Fus are now disseminated in the image-menus. For example, Color to Alpha filter is in Colors-menu. At the beginning, it's disconcerting, but you finish to get used to this because it's more logical.

The figure below show where you can find them in the image-menu.

Figure 13.2 Where find Image-dependent scripts

13.2.5 Standalone Scripts

We will not try to describe every script in depth. Most Script-Fus are very easy to understand and use. At the time of this writing, the following types are installed by default:

- Patterns
- Web page themes
- Logos
- Buttons

Patterns You will find all kinds of pattern-generating scripts here. Generally, they are quite useful because you can add many arguments to your own patterns.

We'll take a look at the Land script. In this script you have to set the image/pattern size, and specify what levels of random to use for your land creation. The colors used to generate the land map are taken from the currently selected gradient in the gradient editor. You must also supply values for the level of detail, land and sea height/depth and the scale. Scale refers to the scale of your map, just as in an ordinary road map, 1:10 will be typed as 10.

Web Page Themes Here is clearly a practical use for scripts. By creating a script for making custom text, logos, buttons arrows, etc., for your web site, you will give them all the same style and shape. You will also be saving a lot of time, because you don't have to create every logo, text or button by hand.

Most of the scripts are quite self-explanatory, but here are some hints:

- Leave all strange characters like ' and " intact.
- Make sure that the pattern specified in the script exists.
- Padding refers to the amount of space around your text.
- A high value for bevel width gives the illusion of a higher button.
- If you type TRUE for "Press", the button will look pushed down.
- Choose transparency if you don't want a solid background. If you choose a solid background, make sure it is the same color as the web page background.

Here you will find all kinds of logo-generating scripts. This is nice, but use it with care, as people might recognize your logo as being made by a known GIMP script. You should rather regard it as a base that you can modify to fit your needs. The dialog for making a logo is more or less the same for all such scripts:

- Logos**
1. In the Text String field, type your logo name, like Frozenriver.
 2. In the Font Size text field, type the size of your logo in pixels.
 3. In the Font text field, type the name of the font that you want to use for your logo.
 4. To choose the color of your logo, just click on the color button. This brings up a color dialog.
 5. If you look at the current command field, you can watch the script run.

Make Buttons Under this headline you'll find two scripts that makes rectangular beveled buttons, with or without round corners (Round Button or Simple Beveled Button). They have a dozen parameters or so, and most of them are similar to those in the logo scripts. You can experiment with different settings to come up with a button you like.

13.2.6 Image-Dependent Scripts

Now, scripts and filters that perform operations on an existing image are accessible directly by the appropriate menu. For example, the script New Brush (script-fu-paste-as-brush) is integrated in the Edit image menu (Edit → Paste as... → New Brush), that is more logical.

Furthermore, a new Color menu has been created that regroups together all that concern works on colors, the hue or level color adjustment tools, etc...

Filters menu and Script-Fu menu are regrouped in one Filters menu and organised according to new categories. Now if a plugin and a filter works similarly, they are nearby in the menu.

The Script-Fu menu only appears if you have loaded additional scripts: for example the gimp-resynthesizer pack corresponding to your Linux distribution (.deb, .rpm, .gz ...).

13.3 A Script-Fu Tutorial

In this training course, we'll introduce you to the fundamentals of Scheme necessary to use Script-Fu, and then build a handy script that you can add to your toolbox of scripts. The script prompts the user for some text, then creates a new image sized perfectly to the text. We will then enhance the script to allow for a buffer of space around the text. We will conclude with a few suggestions for ways to ramp up your knowledge of Script-Fu.

Note



This section as adapted from a tutorial written for the GIMP 1 User Manual by Mike Terry.

13.3.1 Getting Acquainted With Scheme

13.3.1.1 Let's Start Scheme'ing

The first thing to learn is that:

Every statement in Scheme is surrounded by parentheses ().

The second thing you need to know is that:

The function name/operator is always the first item in the parentheses, and the rest of the items are parameters to the function.

However, not everything enclosed in parentheses is a function — they can also be items in a list — but we'll get to that later. This notation is referred to as prefix notation, because the function prefixes everything else. If you're familiar with postfix notation, or own a calculator that uses Reverse Polish Notation (such as most HP calculators), you should have no problem adapting to formulating expressions in Scheme.

The third thing to understand is that:

Mathematical operators are also considered functions, and thus are listed first when writing mathematical expressions.

This follows logically from the prefix notation that we just mentioned.

13.3.1.2 Examples Of Prefix, Infix, And Postfix Notations

Here are some quick examples illustrating the differences between *prefix*, *infix*, and *postfix* notations. We'll add a 1 and 23 together:

- Prefix notation: `+ 1 23` (the way Scheme will want it)
- Infix notation: `1 + 23` (the way we “normally” write it)
- Postfix notation: `1 23 +` (the way many HP calculators will want it)

13.3.1.3 Practicing In Scheme

Now, let's practice what we have just learned. Start up GIMP, if you have not already done so, and choose Filters → Script-Fu → Console. This will start up the Script-Fu Console window, which allows us to work interactively in Scheme. In a matter of moments, the Script-Fu Console will appear:

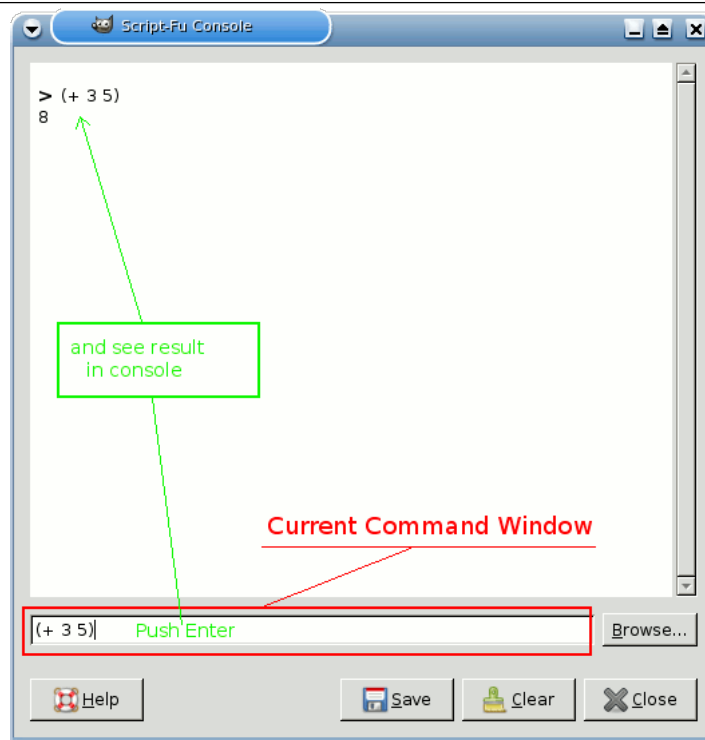
13.3.1.4 The Script-Fu Console Window

At the bottom of this window is an entry-field ought to be entitled Current Command. Here, we can test out simple Scheme commands interactively. Let's start out easy, and add some numbers:

```
(+ 3 5)
```

Typing this in and hitting **Enter** yields the expected answer of 8 in the center window.

Figure 13.3 Use Script-Fu Console.



Now, what if we wanted to add more than one number? The “+” function can take two or more arguments, so this is not a problem:

```
(+ 3 5 6)
```

This also yields the expected answer of 14.

So far, so good — we type in a Scheme statement and it’s executed immediately in the Script-Fu Console window. Now for a word of caution...

13.3.1.5 Watch Out For Extra Parentheses

If you’re like me, you’re used to being able to use extra parentheses whenever you want to — like when you’re typing a complex mathematical equation and you want to separate the parts by parentheses to make it clearer when you read it. In Scheme, you have to be careful and not insert these extra parentheses incorrectly. For example, say we wanted to add 3 to the result of adding 5 and 6 together:

```
3 + (5 + 6) + 7 = ?
```

Knowing that the + operator can take a list of numbers to add, you might be tempted to convert the above to the following:

```
(+ 3 (5 6) 7)
```

However, this is incorrect — remember, every statement in Scheme starts and ends with parens, so the Scheme interpreter will think that you’re trying to call a function named “5” in the second group of parens, rather than summing those numbers before adding them to 3.

The correct way to write the above statement would be:

```
(+ 3 (+ 5 6) 7)
```

13.3.1.6 Make Sure You Have The Proper Spacing, Too

If you are familiar with other programming languages, like C/C++, Perl or Java, you know that you don’t need white space around mathematical operators to properly form an expression:

```
3+5, 3 +5, 3+ 5
```

These are all accepted by C/C++, Perl and Java compilers. However, the same is not true for Scheme. You must have a space after a mathematical operator (or any other function name or operator) in Scheme for it to be correctly interpreted by the Scheme interpreter.

Practice a bit with simple mathematical equations in the Script-Fu Console until you’re totally comfortable with these initial concepts.

13.3.2 Variables And Functions

Now that we know that every Scheme statement is enclosed in parentheses, and that the function name/-operator is listed first, we need to know how to create and use variables, and how to create and use functions. We’ll start with the variables.

13.3.2.1 Declaring Variables

Although there are a couple of different methods for declaring variables, the preferred method is to use the **let*** construct. If you’re familiar with other programming languages, this construct is equivalent to defining a list of local variables and a scope in which they’re active. As an example, to declare two variables, a and b, initialized to 1 and 2, respectively, you’d write:

```
(let*
  (
    (a 1)
    (b 2)
  )
  (+ a b)
)
```

or, as one line:

```
(let* ( ( a 1) ( b 2) ) (+ a b) )
```

Note



You'll have to put all of this on one line if you're using the console window. In general, however, you'll want to adopt a similar practice of indentation to help make your scripts more readable. We'll talk a bit more about this in the section on White Space.

This declares two local variables, `a` and `b`, initializes them, then prints the sum of the two variables.

13.3.2.2 What Is A Local Variable?

You'll notice that we wrote the summation `(+ a b)` within the parens of the `let*` expression, not after it.

This is because the `let*` statement defines an area in your script in which the declared variables are usable; if you type the `(+ a b)` statement after the `(let* ...)` statement, you'll get an error, because the declared variables are only valid within the context of the `let*` statement; they are what programmers call local variables.

13.3.2.3 The General Syntax Of `let*`

The general form of a `let*` statement is:

```
(let* ( variables )
      expressions )
```

where variables are declared within parens, e.g., `(a 2)`, and expressions are any valid Scheme expressions. Remember that the variables declared here are only valid within the `let*` statement — they're local variables.

13.3.2.4 White Space

Previously, we mentioned the fact that you'll probably want to use indentation to help clarify and organize your scripts. This is a good policy to adopt, and is not a problem in Scheme — white space is ignored by the Scheme interpreter, and can thus be liberally applied to help clarify and organize the code within a script. However, if you're working in Script-Fu's Console window, you'll have to enter an entire expression on one line; that is, everything between the opening and closing parens of an expression must come on one line in the Script-Fu Console window.

13.3.2.5 Assigning A New Value To A Variable

Once you've initialized a variable, you might need to change its value later on in the script. Use the `set!` statement to change the variable's value:

```
(let* ( (theNum 10) ) (set! theNum (+ theNum theNum)) )
```

Try to guess what the above statement will do, then go ahead and enter it in the Script-Fu Console window.

Note



The `\` indicates that there is no line break. Ignore it (don't type it in your Script-Fu console and don't hit **Enter**), just continue with the next line.

13.3.2.6 Functions

Now that you've got the hang of variables, let's get to work with some functions. You declare a function with the following syntax:

```
(define
  (
    name
    param-list
  )
  expressions
)
```

where *name* is the name assigned to this function, *param-list* is a space-delimited list of parameter names, and *expressions* is a series of expressions that the function executes when it's called. For example:

```
(define (AddXY inX inY) (+ inX inY) )
```

AddXY is the function's name and inX and inY are the variables. This function takes its two parameters and adds them together.

If you've programmed in other imperative languages (like C/C++, Java, Pascal, etc.), you might notice that a couple of things are absent in this function definition when compared to other programming languages.

- First, notice that the parameters don't have any "types" (that is, we didn't declare them as strings, or integers, etc.). Scheme is a type-less language. This is handy and allows for quicker script writing.
- Second, notice that we don't need to worry about how to "return" the result of our function — the last statement is the value "returned" when calling this function. Type the function into the console, then try something like:

```
(AddXY (AddXY 5 6) 4)
```

13.3.3 Lists, Lists And More Lists

We've trained you in variables and functions, and now enter the murky swamps of Scheme's lists.

13.3.3.1 Defining A List

Before we talk more about lists, it is necessary that you know the difference between atomic values and lists.

You've already seen atomic values when we initialized variables in the previous lesson. An atomic value is a single value. So, for example, we can assign the variable "x" the single value of 8 in the following statement:

```
(let* ( (x 8) ) x)
```

(We added the expression x at the end to print out the value assigned to x—normally you won't need to do this. Notice how let* operates just like a function: The value of the last statement is the value returned.)

A variable may also refer to a list of values, rather than a single value. To assign the variable x the list of values 1, 3, 5, we'd type:

```
(let* ( (x '(1 3 5))) x)
```

Try typing both statements into the Script-Fu Console and notice how it replies. When you type the first statement in, it simply replies with the result:

```
8
```

However, when you type in the other statement, it replies with the following result:

```
(1 3 5)
```

When it replies with the value 8 it is informing you that `x` contains the atomic value 8. However, when it replies with `(1 3 5)`, it is then informing you that `x` contains not a single value, but a list of values. Notice that there are no commas in our declaration or assignment of the list, nor in the printed result.

The syntax to define a list is:

```
' (a b c)
```

where `a`, `b`, and `c` are literals. We use the apostrophe (`'`) to indicate that what follows in the parentheses is a list of literal values, rather than a function or expression.

An empty list can be defined as such:

```
' ()
```

or simply:

```
()
```

Lists can contain atomic values, as well as other lists:

```
(let*
  (
    (x
      ' ("GIMP" (1 2 3) ("is" ("great" () ) ) )
    )
  )
  x
)
```

Notice that after the first apostrophe, you no longer need to use an apostrophe when defining the inner lists. Go ahead and copy the statement into the Script-Fu Console and see what it returns.

You should notice that the result returned is not a list of single, atomic values; rather, it is a list of a literal (`"The GIMP"`), the list `(1 2 3)`, etc.

13.3.3.2 How To Think Of Lists

It's useful to think of lists as composed of a "head" and a "tail". The head is the first element of the list, the tail the rest of the list. You'll see why this is important when we discuss how to add to lists and how to access elements in the list.

13.3.3.3 Creating Lists Through Concatenation (The Cons Function)

One of the more common functions you'll encounter is the `cons` function. It takes a value and places it to its second argument, a list. From the previous section, I suggested that you think of a list as being composed of an element (the head) and the remainder of the list (the tail). This is exactly how `cons` functions — it adds an element to the head of a list. Thus, you could create a list as follows:

```
(cons 1 '(2 3 4) )
```

The result is the list `(1 2 3 4)`.

You could also create a list with one element:

```
(cons 1 () )
```

You can use previously declared variables in place of any literals, as you would expect.

13.3.3.4 Defining A List Using The list Function

To define a list composed of literals or previously declared variables, use the `list` function:

```
(list 5 4 3 a b c)
```

This will compose and return a list containing the values held by the variables `a`, `b` and `c`. For example:

```
(let* (
      (a 1)
      (b 2)
      (c 3)
    )
      (list 5 4 3 a b c)
    )
```

This code creates the list (5 4 3 1 2 3).

13.3.3.5 Accessing Values In A List

To access the values in a list, use the functions `car` and `cdr`, which return the first element of the list and the rest of the list, respectively. These functions break the list down into the head::tail construct I mentioned earlier.

13.3.3.6 The `car` Function

`car` returns the first element of the list (the head of the list). The list needs to be non-null. Thus, the following returns the first element of the list:

```
(car '("first" 2 "third"))
```

which is:

```
"first"
```

13.3.3.7 The `cdr` function

`cdr` returns the rest of the list after the first element (the tail of the list). If there is only one element in the list, it returns an empty list.

```
(cdr '("first" 2 "third"))
```

returns:

```
(2 "third")
```

whereas the following:

```
(cdr '("one and only"))
```

returns:

```
()
```

13.3.3.8 Accessing Other Elements In A List

OK, great, we can get the first element in a list, as well as the rest of the list, but how do we access the second, third or other elements of a list? There exist several "convenience" functions to access, for example, the head of the head of the tail of a list (`caadr`), the tail of the tail of a list (`cddr`), etc.

The basic naming convention is easy: The a's and d's represent the heads and tails of lists, so

```
(car (cdr (car x) ) )
```

could be written as:

```
(cadar x)
```

To get some practice with list-accessing functions, try typing in the following (except all on one line if you're using the console); use different variations of `car` and `cdr` to access the different elements of the list:

```
(let* (
  (x '( (1 2 (3 4 5) 6) 7 8 (9 10) ))
)
; place your car/cdr code here
)
```

Try accessing the number 3 in the list using only two function calls. If you can do that, you're on your way to becoming a Script-Fu Master!

Note



In Scheme, a semicolon (;) marks a comment. It, and anything that follows it on the same line, are ignored by the script interpreter, so you can use this to add comments to jog your memory when you look at the script later.

13.3.4 Your First Script-Fu Script

Do you not need to stop and catch your breath? No? Well then, let's proceed with your fourth lesson — your first Script-Fu Script.

13.3.4.1 Creating A Text Box Script

One of the most common operations I perform in GIMP is creating a box with some text in it for a web page, a logo or whatever. However, you never quite know how big to make the initial image when you start out. You don't know how much space the text will fill with the font and font size you want.

The Script-Fu Master (and student) will quickly realize that this problem can easily be solved and automated with Script-Fu.

We will, therefore, create a script, called Text Box, which creates an image correctly sized to fit snugly around a line of text the user inputs. We'll also let the user choose the font, font size and text color.

13.3.4.2 Editing And Storing Your Scripts

Up until now, we've been working in the Script-Fu Console. Now, however, we're going to switch to editing script text files.

Where you place your scripts is a matter of preference — if you have access to GIMP's default script directory, you can place your scripts there. However, I prefer keeping my personal scripts in my own script directory, to keep them separate from the factory-installed scripts.

In the `~/ .config/GIMP/2.10/` directory that GIMP made off of your home directory, you should find a directory called `scripts`. GIMP will automatically look in your `~/ .config/GIMP/2.10/` directory for a `scripts` directory, and add the scripts in this directory to the Script-Fu database. You should place your personal scripts here.

13.3.4.3 The Bare Essentials

Every Script-Fu script defines at least one function, which is the script's main function. This is where you do the work.

Every script must also register with the procedural database, so you can access it within GIMP.

We'll define the main function first:

```
(define (script-fu-text-box inText inFont inFontSize inTextColor))
```

Here, we've defined a new function called `script-fu-text-box` that takes four parameters, which will later correspond to some text, a font, the font size, and the text's color. The function is currently empty and thus does nothing. So far, so good — nothing new, nothing fancy.

13.3.4.4 Naming Conventions

Scheme's naming conventions seem to prefer lowercase letters with hyphens, which I've followed in the naming of the function. However, I've departed from the convention with the parameters. I like more descriptive names for my parameters and variables, and thus add the "in" prefix to the parameters so I can quickly see that they're values passed into the script, rather than created within it. I use the prefix "the" for variables defined within the script.

It's GIMP convention to name your script functions `script-fu-abc`, because then when they're listed in the procedural database, they'll all show up under Script-Fu when you're listing the functions. This also helps distinguish them from plug-ins.

13.3.4.5 Registering The Function

Now, let's register the function with GIMP. This is done by calling the function `script-fu-register`. When GIMP reads in a script, it will execute this function, which registers the script with the procedural database. You can place this function call wherever you wish in your script, but I usually place it at the end, after all my other code.

Here's the listing for registering this function (I will explain all its parameters in a minute):

```
(script-fu-register
  "script-fu-text-box"           ;func name
  "Text Box"                   ;menu label
  "Creates a simple text box, sized to fit\
  around the user's choice of text,\
  font, font size, and color."   ;description
  "Michael Terry"              ;author
  "copyright 1997, Michael Terry;\
  2009, the GIMP Documentation Team" ;copyright notice
  "October 27, 1997"           ;date created
  ""                           ;image type that the script works on
  SF-STRING    "Text"          "Text Box" ;a string variable
  SF-FONT      "Font"          "Charter"  ;a font variable
  SF-ADJUSTMENT "Font size"    '(50 1 1000 1 10 0 1)
  SF-COLOR     "Color"         '(0 0 0) ;a spin-button
  ;color variable
)
(script-fu-menu-register "script-fu-text-box" "<Image>/File/Create/Text")
```

If you save these functions in a text file with a `.scm` suffix in your script directory, then choose Filters → Script-Fu → Refresh Scripts, this new script will appear as File → Create → Text → Text Box.

If you invoke this new script, it won't do anything, of course, but you can view the prompts you created when registering the script (more information about what we did is covered next).

Finally, if you invoke the Procedure Browser (Help → Procedure Browser), you'll notice that our script now appears in the database.

13.3.4.6 Steps For Registering The Script

To register our script with GIMP, we call the function `script-fu-register`, fill in the seven required parameters and add our script's own parameters, along with a description and default value for each parameter.

The Required Parameters

- The *name* of the function we defined. This is the function called when our script is invoked (the entry-point into our script). This is necessary because we may define additional functions within the same file, and GIMP needs to know which of these functions to call. In our example, we only defined one function, `text-box`, which we registered.
- The *location* in the menu where the script will be inserted. The exact location of the script is specified like a path in Unix, with the root of the path being image menu as `<Image>`.¹

¹Before version 2.6, `<Toolbox>` could be also used, but now the toolbox menu is removed, so don't use it.

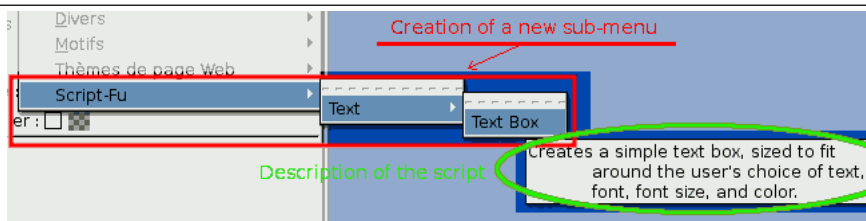
If your script does not operate on an existing image (and thus creates a new image, like our Text Box script will), you'll want to insert it in the image window menu, which you can access through the image menu bar, by right-clicking the image window, by clicking the menu button icon at the left-top corner of the image window, or by pressing **F10**.

If your script is intended to work on an image being edited, you'll want to insert it in the image window menu. The rest of the path points to the menu lists, menus and sub-menus. Thus, we registered our Text Box script in the Text menu of the Create menu of the File menu.² (File → Create → Text → Text Box).

If you notice, the Text sub-menu in the File/Create menu wasn't there when we began — GIMP automatically creates any menus not already existing.

- A *description* of your script, to be displayed in the Procedure Browser.
- *Your name* (the author of the script).
- *Copyright* information.
- The *date* the script was made, or the last revision of the script.
- The *types* of images the script works on. This may be any of the following: RGB, RGBA, GRAY, GRAYA, INDEXED, INDEXEDA. Or it may be none at all — in our case, we're creating an image, and thus don't need to define the type of image on which we work.

Figure 13.4 The menu of our script.



13.3.4.7 Registering The Script's Parameters

Once we have listed the required parameters, we then need to list the parameters that correspond to the parameters our script needs. When we list these params, we give hints as to what their types are. This is for the dialog which pops up when the user selects our script. We also provide a default value.

This section of the registration process has the following format:

Param Type	Description	Example
SF-IMAGE	If your script operates on an open image, this should be the first parameter after the required parameters. GIMP will pass in a reference to the image in this parameter.	3
SF-DRAWABLE	If your script operates on an open image, this should be the second parameter after the SF-IMAGE param. It refers to the active layer. GIMP will pass in a reference to the active layer in this parameter.	17

²The original, written by Mike, says put the menu entry in the Script-Fu menu of the Xtns menu at the Toolbox, but since version 2.6, the Toolbox menu had been removed and merged with the image window menubar.

Param Type	Description	Example
SF-VALUE	Accepts numbers and strings. Note that quotes must be escaped for default text, so better use SF-STRING.	42
SF-STRING	Accepts strings.	"Some text"
SF-COLOR	Indicates that a color is requested in this parameter.	'(0 102 255)
SF-TOGGLE	A checkbox is displayed, to get a Boolean value.	TRUE or FALSE

13.3.4.8 The Script-Fu parameter API³

Note



Beside the above parameter types there are more types for the interactive mode, each of them will create a widget in the control dialog. You will find a list of these parameters with descriptions and examples in the test script `plug-ins/script-fu/scripts/test-sphere.scm` shipped with the GIMP source code.

Param Type	Description
SF-ADJUSTMENT	<p>Creates an adjustment widget in the dialog. SF-ADJUSTMENT "label" (value lower upper step_inc page_inc digits type)</p> <p>Widget arguments list</p> <p><i>Element: "label", Description: Text printed before the widget.</i></p> <p><i>Element: value, Description: Value print at the start.</i></p> <p><i>Element: lower / upper, Description: The lower / upper values (range of choice).</i></p> <p><i>Element: step_inc, Description: Increment/decrement value.</i></p> <p><i>Element: page_inc, Description: Increment/decrement value using page key.</i></p> <p><i>Element: digits, Description: Digits after the point (decimal part).</i></p> <p><i>Element: type, Description: One of: SF-SLIDER or 0, SF-SPINNER or 1</i></p>

³This section is not part of the original tutorial.

Param Type	Description
SF-COLOR	<p>Creates a color button in the dialog. SF-COLOR "label" '(red green blue) or SF-COLOR "label" "color" Widget arguments list <i>Element: "label", Description: Text printed before the widget.</i> <i>Element: '(red green blue), Description: List of three values for the red, green and blue components.</i> <i>Element: "color", Description: Color name in CSS notation.</i></p>
SF-FONT	<p>Creates a font-selection widget in the dialog. It returns a fontname as a string. There are two new gimp-text procedures to ease the use of this return parameter: (gimp-text-fontname image drawable x-pos y-pos text border antialias size unit font) (gimp-text-get-extents-fontname text size unit font) where font is the fontname you get. The size specified in the fontname is silently ignored. It is only used in the font-selector. So you are asked to set it to a useful value (24 pixels is a good choice). SF-FONT "label" "fontname" Widget arguments list <i>Element: "label", Description: Text printed before the widget.</i> <i>Element: "fontname", Description: Name of the default font.</i></p>
SF-BRUSH	<p>It will create a widget in the control dialog. The widget consists of a preview area (which when pressed will produce a popup preview) and a button with the "... " label. The button will popup a dialog where brushes can be selected and each of the characteristics of the brush can be modified. SF-BRUSH "Brush" ("Circle (03)" 100 44 0) Here the brush dialog will be popped up with a default brush of Circle (03) opacity 100 spacing 44 and paint mode of Normal (value 0). If this selection was unchanged the value passed to the function as a parameter would be ("Circle (03)" 100 44 0).</p>

Param Type	Description
SF-PATTERN	<p>It will create a widget in the control dialog. The widget consists of a preview area (which when pressed will produce a popup preview) and a button with the "... " label. The button will popup a dialog where patterns can be selected.</p> <p>SF-PATTERN "Pattern" "Maple Leaves"</p> <p>The value returned when the script is invoked is a string containing the pattern name. If the above selection was not altered the string would contain "Maple Leaves".</p>
SF-GRADIENT	<p>It will create a widget in the control dialog. The widget consists of a button containing a preview of the selected gradient.</p> <p>If the button is pressed a gradient selection dialog will popup.</p> <p>SF-GRADIENT "Gradient" "Deep Sea"</p> <p>The value returned when the script is invoked is a string containing the gradient name. If the above selection was not altered the string would contain "Deep Sea".</p>
SF-PALETTE	<p>It will create a widget in the control dialog. The widget consists of a button containing the name of the selected palette.</p> <p>If the button is pressed a palette selection dialog will popup.</p> <p>SF-PALETTE "Palette" "Named Colors"</p> <p>The value returned when the script is invoked is a string containing the palette name. If the above selection was not altered the string would contain "Named Colors".</p>
SF-FILENAME	<p>It will create a widget in the control dialog. The widget consists of a button containing the name of a file.</p> <p>If the button is pressed a file selection dialog will popup.</p> <p>SF-FILENAME "label" (string-append "" gimp-data-directory "/scripts/beavis.jpg")</p> <p>The value returned when the script is invoked is a string containing the filename.</p>
SF-DIRNAME	<p>Only useful in interactive mode. Very similar to SF-FILENAME, but the created widget allows to choose a directory instead of a file.</p> <p>SF-DIRNAME "label" "/var/tmp/images"</p> <p>The value returned when the script is invoked is a string containing the dirname.</p>

Param Type	Description
SF-OPTION	It will create a widget in the control dialog. The widget is a combo-box showing the options that are passed as a list. The first option is the default choice. SF-OPTION "label" ("option1" "option2") The value returned when the script is invoked is the number of the chosen option, where the option first is counted as 0.
SF-ENUM	It will create a widget in the control dialog. The widget is a combo-box showing all enum values for the given enum type. This has to be the name of a registered enum, without the "Gimp" prefix. The second parameter specifies the default value, using the enum value's nick. SF-ENUM "Interpolation" ("InterpolationType" "linear") The value returned when the script is invoked corresponds to chosen enum value.

13.3.5 Giving Our Script Some Guts

Let us continue with our training and add some functionality to our script.

13.3.5.1 Creating A New Image

In the previous lesson, we created an empty function and registered it with GIMP. In this lesson, we want to provide functionality to our script — we want to create a new image, add the user's text to it and resize the image to fit the text exactly.

Once you know how to set variables, define functions and access list members, the rest is all downhill — all you need to do is familiarize yourself with the functions available in GIMP's procedural database and call those functions directly. So fire up the Section 16.12.7 and let's get cookin'!

Let's begin by making a new image. We'll create a new variable, `theImage`, set to the result of calling GIMP's built-in function `gimp-image-new`.

As you can see from the DB Browser, the function `gimp-image-new` takes three parameters — the image's width, height and the type of image. Because we'll later resize the image to fit the text, we'll make a 10x10 pixels RGB image. We'll store the image's width and sizes in some variables, too, as we'll refer to and manipulate them later in the script.

```
(define (script-fu-text-box inText inFont inFontSize inTextColor)
  (let*
    (
      ; define our local variables
      ; create a new image:
      (theImageWidth 10)
      (theImageHeight 10)
      (theImage (car
                  (gimp-image-new
                   theImageWidth
                   theImageHeight
                   RGB
                  )
                )
            )
    )
    (theText) ;a declaration for the text
              ;we create later
```

Note: We used the value `RGB` to specify that the image is an RGB image. We could have also used `0`, but `RGB` is more descriptive when we glance at the code.

You should also notice that we took the head of the result of the function call. This may seem strange, because the database explicitly tells us that it returns only one value — the ID of the newly created image. However, all GIMP functions return a list, even if there is only one element in the list, so we need to get the head of the list.

13.3.5.2 Adding A New Layer To The Image

Now that we have an image, we need to add a layer to it. We'll call the `gimp-layer-new` function to create the layer, passing in the ID of the image we just created. (From now on, instead of listing the complete function, we'll only list the lines we're adding to it. You can see the complete script [here](#).) Because we've declared all of the local variables we'll use, we'll also close the parentheses marking the end of our variable declarations:

```

;create a new layer for the image:
  (theLayer
    (car
      (gimp-layer-new
        theImage
        theImageWidth
        theImageHeight
        RGB-IMAGE
        "layer 1"
        100
        LAYER-MODE-NORMAL
      )
    )
  )
) ;end of our local variables

```

Once we have the new layer, we need to add it to the image:

```
(gimp-image-add-layer theImage theLayer 0)
```

Now, just for fun, let's see the fruits of our labors up until this point, and add this line to show the new, empty image:

```
(gimp-display-new theImage)
```

Save your work, select `Filters → Script-Fu → Refresh Scripts`, run the script and a new image should pop up. It will probably contain garbage (random colors), because we haven't erased it. We'll get to that in a second.

13.3.5.3 Adding The Text

Go ahead and remove the line to display the image (or comment it out with a `(;)` as the first character of the line).

Before we add text to the image, we need to set the background and foreground colors so that the text appears in the color the user specified. We'll use the `gimp-context-set-back/foreground` functions:

```
(gimp-context-set-background '(255 255 255) )
(gimp-context-set-foreground inTextColor)
```

With the colors properly set, let's now clean out the garbage currently in the image by filling the drawable with the background color:

```
(gimp-drawable-fill theLayer BACKGROUND-FILL)
```

With the image cleared, we're ready to add some text:

```
(set! theText
  (car
    (gimp-text-fontname
      theImage theLayer
      0 0
      inText

```

```

                                0
                                TRUE
                                inFontSize PIXELS
                                "Sans")
                                )
)

```

Although a long function call, it's fairly straightforward if you go over the parameters while looking at the function's entry in the DB Browser. Basically, we're creating a new text layer and assigning it to the variable `theText`.

Now that we have the text, we can grab its width and height and resize the image and the image's layer to the text's size:

```

(set! theImageWidth  (car (gimp-drawable-width  theText) ) )
(set! theImageHeight (car (gimp-drawable-height theText) ) )

(gimp-image-resize theImage theImageWidth theImageHeight 0 0)

(gimp-layer-resize theLayer theImageWidth theImageHeight 0 0)

```

If you're like me, you're probably wondering what a drawable is when compared to a layer. The difference between the two is that a drawable is anything that can be drawn into, including layers but also channels, layer masks, the selection, etc; a layer is a more specific version of a drawable. In most cases, the distinction is not important.

With the image ready to go, we can now re-add our display line:

```
(gimp-display-new theImage)
```

Save your work, refresh the database and give your first script a run!

13.3.5.4 Clearing The Dirty Flag

If you try to close the image created without first saving the file, GIMP will ask you if you want to save your work before you close the image. It asks this because the image is marked as dirty, or unsaved. In the case of our script, this is a nuisance for the times when we simply give it a test run and don't add or change anything in the resulting image — that is, our work is easily reproducible in such a simple script, so it makes sense to get rid of this dirty flag.

To do this, we can clear the dirty flag after displaying the image:

```
(gimp-image-clean-all theImage)
```

This will set dirty count to 0, making it appear to be a "clean" image.

Whether to add this line or not is a matter of personal taste. I use it in scripts that produce new images, where the results are trivial, as in this case. If your script is very complicated, or if it works on an existing image, you will probably not want to use this function.

13.3.6 Extending The Text Box Script

13.3.6.1 Handling Undo Correctly

When creating a script, you want to give your users the ability to undo their actions, should they make a mistake. This is easily accomplished by calling the functions `gimp-undo-push-group-start` and `gimp-undo-push-group-end` around the code that manipulates the image. You can think of them as matched statements that let GIMP know when to start and stop recording manipulations on the image, so that those manipulations can later be undone.

If you are creating a new image entirely, it doesn't make sense to use these functions because you're not changing an existing image. However, when you are changing an existing image, you most surely want to use these functions.

Undoing a script works nearly flawlessly when using these functions.

13.3.6.2 Extending The Script A Little More

Now that we have a very handy-dandy script to create text boxes, let's add two features to it:

- Currently, the image is resized to fit exactly around the text — there's no room for anything, like drop shadows or special effects (even though many scripts will automatically resize the image as necessary). Let's add a buffer around the text, and even let the user specify how much buffer to add as a percentage of the size of the resultant text.
- This script could easily be used in other scripts that work with text. Let's extend it so that it returns the image and the layers, so other scripts can call this script and use the image and layers we create.

13.3.6.3 Modifying The Parameters And The Registration Function

To let the user specify the amount of buffer, we'll add a parameter to our function and the registration function:

```
(define (script-fu-text-box inTest inFont inFontSize inTextColor inBufferAmount ↵
)
(let*
(
; define our local variables
; create a new image:
(theImageWidth 10)
(theImageHeight 10)
(theImage (car
(gimp-image-new
theImageWidth
theImageHeight
RGB
)
)
)
(theText) ;a declaration for the text
;we create later

(theBuffer) ;added

(theLayer
(car
(gimp-layer-new
theImage
theImageWidth
theImageHeight
RGB-IMAGE
"layer 1"
100
LAYER-MODE-NORMAL
)
)
) ;end of our local variables

[Code here]
)
```

```
(script-fu-register
"script-fu-text-box" ;func name
"Text Box" ;menu label
"Creates a simple text box, sized to fit\
around the user's choice of text,\
font, font size, and color." ;description
"Michael Terry" ;author
"copyright 1997, Michael Terry;\
```

```

    2009, the GIMP Documentation Team"           ;copyright notice
    "October 27, 1997"                          ;date created
    ""                                           ;image type that the script works on
    SF-STRING      "Text"           "Text Box"   ;a string variable
    SF-FONT        "Font"           "Charter"    ;a font variable
    SF-ADJUSTMENT "Font size"      '(50 1 1000 1 10 0 1)
                                           ;a spin-button
    SF-COLOR       "Color"          '(0 0 0)     ;color variable
    SF-ADJUSTMENT "Buffer amount"  '(35 0 100 1 10 1 0)
                                           ;a slider
)
(script-fu-menu-register "script-fu-text-box" "<Image>/Font/Create/Text")

```

13.3.6.4 Adding The New Code

We're going to add code in two places: right before we resize the image, and at the end of the script (to return the new image, the layer and the text).

After we get the text's height and width, we need to resize these values based on the buffer amount specified by the user. We won't do any error checking to make sure it's in the range of 0-100% because it's not life-threatening, and because there's no reason why the user can't enter a value like "200" as the percent of buffer to add.

```

(set! theBuffer (* theImageHeight (/ inBufferAmount 100) ) )

(set! theImageHeight (+ theImageHeight theBuffer theBuffer) )
(set! theImageWidth  (+ theImageWidth  theBuffer theBuffer) )

```

All we're doing here is setting the buffer based on the height of the text, and adding it twice to both the height and width of our new image. (We add it twice to both dimensions because the buffer needs to be added to both sides of the text.)

Now that we have resized the image to allow for a buffer, we need to center the text within the image. This is done by moving it to the (x, y) coordinates of (theBuffer, theBuffer). I added this line after resizing the layer and the image:

```
(gimp-layer-set-offsets theText theBuffer theBuffer)
```

Go ahead and save your script, and try it out after refreshing the database.

All that is left to do is return our image, the layer, and the text layer. After displaying the image, we add this line:

```
(list theImage theLayer theText)
```

This is the last line of the function, making this list available to other scripts that want to use it.

To use our new text box script in another script, we could write something like the following:

```

(set! theResult (script-fu-text-box
    "Some text"
    "Charter" "30"
    '(0 0 0)
    "35"
)
)
(gimp-image-flatten (car theResult))

```

Congratulations, you are on your way to your Black Belt of Script-Fu!

13.3.7 Your script and its working

13.3.7.1 What you write

Below the complete script:

```

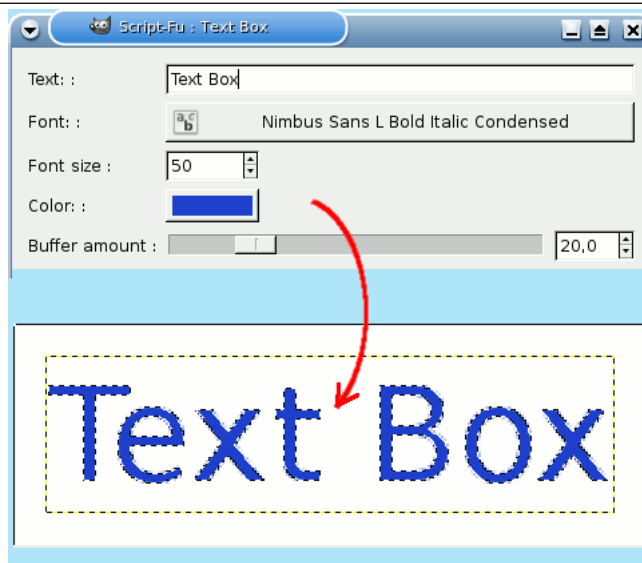
(script-fu-register
  "script-fu-text-box"                ;func name
  "Text Box"                          ;menu label
  "Creates a simple text box, sized to fit\
   around the user's choice of text,\
   font, font size, and color."      ;description
  "Michael Terry"                     ;author
  "copyright 1997, Michael Terry;\
   2009, the GIMP Documentation Team" ;copyright notice
  "October 27, 1997"                  ;date created
  ""                                  ;image type that the script works on
  SF-STRING      "Text"      "Text Box" ;a string variable
  SF-FONT        "Font"      "Charter"  ;a font variable
  SF-ADJUSTMENT "Font size"  '(50 1 1000 1 10 0 1) ;a spin-button
  SF-COLOR       "Color"     '(0 0 0)    ;color variable
  SF-ADJUSTMENT "Buffer amount" '(35 0 100 1 10 1 0) ;a slider
)
(script-fu-menu-register "script-fu-text-box" "<Image>/File/Create/Text")
(define (script-fu-text-box inText inFont inFontSize inTextColor inBufferAmount ←
)
  (let*
    (
      ; define our local variables
      ; create a new image:
      (theImageWidth 10)
      (theImageHeight 10)
      (theImage)
      (theImage
        (car
          (gimp-image-new
            theImageWidth
            theImageHeight
            RGB
          )
        )
      )
      (theText) ;a declaration for the text
      (theBuffer) ;create a new layer for the image
      (theLayer
        (car
          (gimp-layer-new
            theImage
            theImageWidth
            theImageHeight
            RGB-IMAGE
            "layer 1"
            100
            LAYER-MODE-NORMAL
          )
        )
      )
    )
  ) ;end of our local variables
  (gimp-image-add-layer theImage theLayer 0)
  (gimp-context-set-background '(255 255 255) )
  (gimp-context-set-foreground inTextColor)
  (gimp-drawable-fill theLayer BACKGROUND-FILL)
  (set! theText
    (car
      (gimp-text-fontname
        theImage theLayer
        0 0

```

```
        inText
        0
        TRUE
        inFontSize PIXELS
        "Sans")
    )
)
(set! theImageWidth (car (gimp-drawable-width theText) ) )
(set! theImageHeight (car (gimp-drawable-height theText) ) )
(set! theBuffer (* theImageHeight (/ inBufferAmount 100) ) )
(set! theImageHeight (+ theImageHeight theBuffer theBuffer) )
(set! theImageWidth (+ theImageWidth theBuffer theBuffer) )
(gimp-image-resize theImage theImageWidth theImageHeight 0 0)
(gimp-layer-resize theLayer theImageWidth theImageHeight 0 0)
(gimp-layer-set-offsets theText theBuffer theBuffer)
(gimp-display-new theImage)
(list theImage theLayer theText)
)
)
```

13.3.7.2 What you obtain

Figure 13.5 And the result on the screen.



Part III

Function Reference

Chapter 14

Tools

14.1 The Toolbox

14.1.1 Introduction

GIMP provides a comprehensive toolbox in order to quickly perform basic tasks such as making selections or drawing paths. The many tools contained within GIMP's toolbox are discussed in detail here.

(In case you're curious, in GIMP lingo a "tool" is a way of acting on an image that requires access to its display, either to let you indicate what you want to do by moving the pointer around inside the display, or to show you interactively the results of changes that you have made. But if you want to think of a tool as a saw, and an image as a piece of wood, it probably won't do you a great deal of harm.)

Note



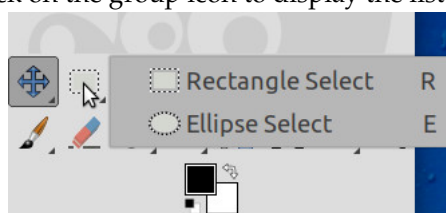
See [Main Windows: The Toolbox](#) for an overview of the toolbox and its components.

GIMP has a diverse assortment of tools that let you perform a large variety of tasks. The tools can be thought of as falling into five categories:

- *Selection tools*, which specify or modify the portion of the image that will be affected by subsequent actions;
- *Paint tools*, which alter the colors in some part of the image;
- *Transform tools*, which alter the geometry of the image;
- *Color tools*, which alter the colors in the image as a whole;
- *Other tools*, which don't fall into the other three categories.

14.1.2 Tool Icons

With GIMP-2.10.18, tool icons can be grouped, and this option is enabled by default. Tools groups are marked with a small dark triangle at the bottom right corner of the icon. The group icon displayed is the first icon in the group. Right click on the group icon to display the list of tools in the group.



You can get the former display back unchecking the Use tool groups option in [Section 12.1.11](#).

Figure 14.1 The Tool Icons in the Toolbox

“Use tool groups” option unchecked. The default order of tools in the toolbox is different since GIMP-2.10.8; you can customize it in the `Interface>Toolbox` page of the Preferences.

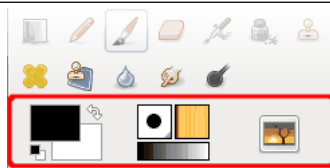
Most tools can be activated by clicking on an icon in the Toolbox. By default, some tools are accessible only via the menus (namely the Color tools are accessible only either as Colors or as Tools → Colors). Every tool, in fact, can be activated from the *Tools* menu; also, every tool can be activated from the keyboard using an accelerator key.

In the default setup, created when GIMP is first installed, not all tools show icons in the Toolbox: the Color tools are omitted. You can customize the set of tools that are shown in the Toolbox in the *Interface > Toolbox* page of the *Preferences*.

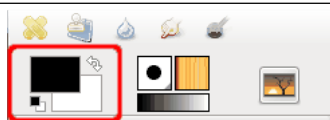
There are two reasons you might want to do this: first, if you only rarely use a tool, it might be easier to find the tools you want if the distracting icon is removed; second, if you use the Color tools a lot, you might find it convenient to have icons for them easily available. In any case, regardless of the Toolbox, you can always access any tool at any time using the Tools menu from an image menubar.

The shape of the cursor changes when it is inside an image, to one that indicates which tool is active (if in Preferences you have set Image Windows → Mouse Pointers → Pointer mode → Tool icon).

14.1.3 Color and Indicator Area

Figure 14.2 Color and Indicator Area in the Toolbox

14.1.3.1 Color Area

Figure 14.3 Active Colors in the Toolbox

Color area This area shows GIMP’s basic palette, consisting of two colors, the Foreground and Background, used for painting, filling, and many other operations. Clicking on either of the color displays brings up a Color Editor dialog, which permits you to change it.

Default colors Clicking on this small symbol resets the Foreground and Background colors to black and white, respectively. Pressing the **D** key has the same effect.

Swap FG/BG colors Clicking on the small curved line with two arrowheads causes the Foreground and Background colors to be swapped. Pressing the X key has the same effect.

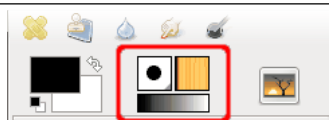
Tip



You can click-and-drag one of these colors directly into a layer: it will fill the whole layer.

14.1.3.2 Tools Indicator Area

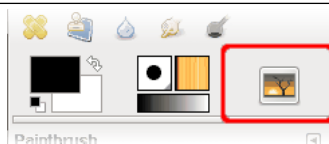
Figure 14.4 Active Brush, Pattern and Gradient in the Toolbox



This part of the Toolbox shows the currently selected brush, pattern, and gradient. Clicking on any of them brings up a dialog that allows you to change it.

14.1.3.3 Active Image Area

Figure 14.5 Active Image in the Toolbox

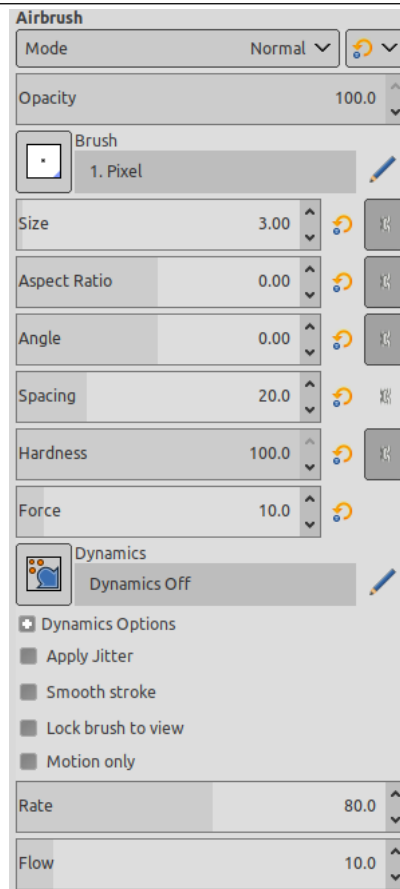


A thumbnail of the active image can be displayed in this area if the “Display Active Image” option is checked in Preferences/Toolbox. If you click on this thumbnail, the “Images” dialog is opened, useful if you have many images on your screen. You can also click and drag this thumbnail to an enabled XDS¹ file manager to directly save the corresponding image.

¹See [XDS].

14.1.4 Tool Options

Figure 14.6 Tool Options Dialog



The Tool Options dialog of the Airbrush tool.

If you have things set up like most people do, activating a tool causes its Tool Options dialog to appear below the Toolbox. If you don't have things set up this way, you probably should: it is very difficult to use tools effectively without being able to manipulate their options.

Tip



The Tool Options appear beneath the Toolbox in the default setup. If you lose it somehow, you can get it back by creating a new Tool Options dialog using Windows → Dockable Dialogs → Tool Options and then docking it below the Toolbox. See the section on [Dialogs and Docking](#) if you need help.

Each tool has its own specific set of options. The choices you make for them are kept throughout the session, until you change them. In fact, the tool options are maintained from session to session. The persistence of tool options across sessions can sometimes be an annoying nuisance: a tool behaves very strangely, and you can't figure out why until you remember that you were using some unusual option the last time you worked with it, two weeks ago.

At the bottom of the Tool Options dialog, four buttons appear:



Save Tool Preset... This button allows you to save the settings for the current tool, so that you can restore them later. It brings up the Section [15.5.1](#) allowing you to give a name for the new preset. When you Restore options, only saved presets for the active tool are shown, so you need not worry about including the name of the tool when you assign a name here.



Restore Tool Preset... This button allows you to restore a previously saved preset of options for the active tool. If no presets have ever been saved for the active tool, the button will be insensitive. Otherwise, clicking it will bring up a menu showing the names of all saved option sets: choosing a menu entry will apply those settings.



Delete Tool Preset This button allows you to delete a previously saved set of options for the active tool. If no option-sets have ever been saved for the active tool, the button will simply repeat the tool name. Otherwise, clicking it will bring up a menu showing the names of all saved presets: the selected preset will be deleted.




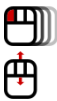
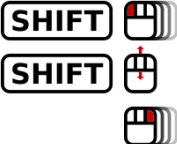



Reset to default values This button resets the options for the active tool to their default values.

New sliders Option sliders have changed with GIMP-2.10.18: Sliders typically used in GEGL-based filters and tools' options now have a compact style by default: they take a lot less space vertically and have a vastly improved behavior. You can use multiple modifiers with either left-click or mouse wheel scrolling:

- **Left-click + drag** changes a value with a default increment.
- **Shift + left-click + drag (or right-click + drag)** changes a value with a smaller step .
- **Ctrl + left-click + drag** changes a value with a larger step.

Here is the full reference:

INTERACTION WITH THE NEW SLIDER WIDGET

	Change the value to what's under the pointer
	Change the value using the default increment
	Change the value using smaller increment
	Change the value using larger increment
	Enter numeric input mode, don't select the value
	Enter numeric input mode, select the value

Hint: any left-click interaction enables numeric input mode

Once you have set the value approximately, you can tune it precisely using the two small arrow buttons at the right of the slider.

The value area in the slider area works as a text editor: there, you can edit the value or enter a new value directly.

For some options, you can drag the pointer outside the tool dialog. For example with the size slider, you can get the maximum value (10000) so.

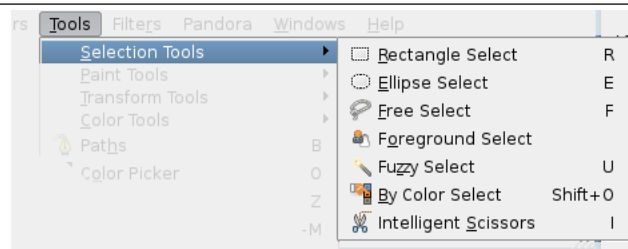
Mouse Scroll-Wheel actions on canvas When using tools, you can use the mouse scroll-wheel, in combination with various modifiers, to do useful things with the tool options of the selected tool:

- **Alt + Mouse-wheel:** increase/decrease *opacity*
- **Shift + Primary + Mouse-wheel:** increase/decrease *aspect ratio*
- **Shift + Alt + Mouse-wheel:** increase/decrease *angle*
- **Primary + Alt + Mouse-wheel:** increase/decrease *size*
- **Shift + Primary + Alt + Mouse-wheel:** increase/decrease *spacing*

Note: the Primary modifier is usually Ctrl or Cmd, depending on your platform.

14.2 Selection Tools

Figure 14.7 The Selection tools



14.2.1 Common Features

Selection tools are designed to select regions from the active layer so you can work on them without affecting the unselected areas. Each tool has its own individual properties, but the selection tools also share a number of options and features in common. These common features are described here; the variations are explained in the following sections for each tool specifically. If you need help with what a “selection” is in GIMP, and how it works, see [Selection](#).

There are seven selection tools:

- the [Rectangle Select](#);
- the [Ellipse Select](#);
- the [Free Select \(the Lasso\)](#);
- the [Select Contiguous Regions \(the Magic Wand\)](#);
- the [Select by Color](#);
- the [Select Shapes from Image \(Intelligent Scissors\)](#) and
- the [Foreground Select](#).

In some ways the Path tool can also be thought of as a selection tool: any closed path can be converted into a selection. It also can do a great deal more, though, and does not share the same set of options with the other selection tools.

14.2.1.1 Key modifiers (Defaults)

The behavior of selection tools is modified if you hold down the **Ctrl**, **Shift**, and/or **Alt** keys while you use them.

Note



Advanced users find the modifier keys very valuable, but novice users often find them confusing. Fortunately, it is possible for most purposes to use the Mode buttons (described below) instead of modifier keys.

Ctrl When creating a selection, holding down the **Ctrl** key can have two different actions according to the way you use it:

- Holding down the key *while drawing* the selection toggles the “Expand from center” option.
- If you hold down the **Ctrl** key *before drawing a selection*, this new selection switches to the Subtract mode. So, this new selection will be subtracted from an existing one as soon as you release the click, as far as they have common pixels.

Alt Holding **Alt** will allow movement of the current selection (only its frame, not its content). If the whole image is moved instead of the selection only, try Shift-Alt. Note that the **Alt** key is sometimes intercepted by the windowing system (meaning that GIMP never knows that it was pressed), so this may not work for everybody.

Shift When creating a selection, holding down the **Shift** key can have two different actions according to the way you use it:

- If you hold down the key *before clicking* to start the selection, this selection will be in *Addition* mode as long as you press the key.
- If you hold down the **Shift** key *after clicking* to start the selection, the effect will depend on the tool you are using: for example, the selection will be a square with the Rectangle Select tool.

Ctrl-Shift Using Ctrl-Shift together can do a variety of things, depending on which tool is used. Common to all selection tools is that the selection mode will be switched to intersection, so that after the operation is finished, the selection will consist of the intersection of the region traced out with the pre-existing selection. It is an exercise for the reader to play with the various combinations available when performing selections while holding Ctrl-Shift and releasing either both or either prior to releasing the mouse Left Button.

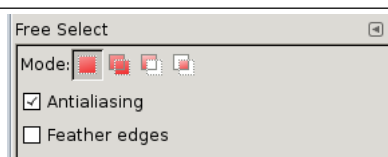
Key modifiers to move selections Ctrl-Alt-Left-click-and-drag and Shift-Alt-Left-click-and-drag are used to move selections. See Section 7.2.1.

Space bar Pressing the **Space** bar while using a selection tool transforms this tool into the Navigation cross as long as you press the bar, allowing you to pan around the image instead of using the scroll-bars when your image is bigger than the canvas. This is the default option: in Preferences/Image Windows, you can toggle the Space bar to the Move tool.

14.2.1.2 Options

Here we describe the tool options that apply to all selection tools: options that apply only to some tools, or that affect each tool differently, are described in the sections devoted to the individual tools. The current settings for these options can be seen in the Tool Options dialog, which you should always have visible when you are using tools. To make the interface consistent, the same options are presented for all selection tools, even though some of them don't have any effect for some of the tools.

Figure 14.8 Common options of selection tools



Mode This determines the way that the selection you create is combined with any pre-existing selection. Note that the functions performed by these buttons can be duplicated using modifier keys, as described above. For the most part, advanced users use the modifier keys; novice users find the mode buttons easier.



Replace mode will cause any existing selection to be destroyed or replaced when the new selection is created.



Add mode will cause the new selection to be added to any existing selection regions.



Subtract mode will remove the new selection area from any existing selection regions.



Intersection mode will make a new selection from the area where the existing selection region and the new selection region overlap.

Antialiasing This option only affects some selection tools: it causes the boundary of the selection to be drawn more smoothly.

Feather Edges This options allows the boundary of the selection to be blurred, so that points near the boundary are only partially selected. For further information regarding feathering, see the glossary entry [Feathering](#).

When this option is checked, a Radius option appears. Default value is 10 pixels: higher image resolution, higher radius.

14.2.2 Rectangle Selection

Figure 14.9 Rectangle Select icon in the Toolbox



The Rectangle Selection tool is designed to select rectangular regions of the active layer: it is the most basic of the selection tools, but very commonly used. For information on selections and how they are used in GIMP see [Selections](#); for information on features common to all selection tools see [Selection Tools](#).

This tool is also used for rendering a rectangle on an image. To render a filled rectangle, create a rectangular selection, and then fill it using the [Bucket Fill tool](#). To create a rectangular outline, the simplest and most flexible approach is to create a rectangular selection and then [stroke](#) it.

14.2.2.1 Activating the tool

You can access the Selection Tool in different ways:

- from the image menu bar Tools → Selection Tools → Rectangle Select,

- by clicking on the tool icon  in the ToolBox,

- by using the keyboard shortcut **R**.

14.2.2.2 Key modifiers

Note



See [Selection Tools](#) for help with modifier keys that affect all these tools in the same way. Only effects options that are specific to this tool are explained here.

Ctrl Pressing the **Ctrl** key after starting your selection, and holding it down until you are finished, causes your starting point to be used as the center of the selected rectangle, instead of a corner. Note that if you press the **Ctrl** key *before* starting to make the selection, the resulting selection will be subtracted from the existing selection. The cursor becomes

Shift If you press the **Shift** key *before* starting the selection, the resulting selection will be added to the existing one. The cursor becomes

Pressing the **Shift** key *after* starting your selection, toggles the Fixed option, and holding it down until you are finished, will constrain the selection to a square, if it is your first selection. Later, with the default Aspect Ratio, your selection will respect the aspect ratio of the previous selection.

Ctrl-Shift Pressing both keys after starting your selection combines the two effects, giving you a square selection centered on your starting point. Note that pressing these keys before starting your selection intersects the resulting selection with the existing one and the pointer change accordingly:

14.2.2.3 Tool manipulation

Figure 14.10 Example of Rectangle Selection.



When this tool is selected the mouse pointer is displayed like this: as soon as it is over the image. A drag and drop allows to get a rectangular (or square) shape. When the mouse button is relaxed, a dotted line (“marching ants”) outlines the selection. It’s not necessary to adjust the selection with care; you can resize it easily later.

When the pointer is moving on the canvas, the pointer and selection aspects change:

- outside the selection it looks like previously; this allows to design a new selection but will erase the existing one if this isn’t combined with an action on the relevant key to add or subtract another selection as described in the previous paragraph.

- within selection peripheral parts, the mouse pointer changes into various shapes when overflying rectangular sensitive and clearly marked areas. These *handles* allow you to resize the selection. In selection corners the pointer changes into a shape according to the context; for instance in the low right corner

it becomes:

. So, by click-and-dragging these areas, you can magnify or shrink the selection size.

Over median selection parts, lateral, low or up, pointer is changed into appropriate shapes according to the context. For instance, when the mouse pointer is over the median right side, the pointer looks



like: . So you can click-and-drag to magnify or to shrink the selection size by moving the chosen boundary.



- inside selection central area the mouse pointer looks like usual for object manipulation, i.e.: . So you can move the whole selection by a click-and-drag.

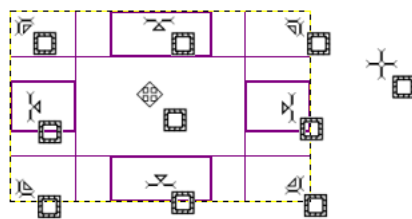
Moreover, if you have not unchecked the Highlight option, your work will be easier because what is out the selection will be darkest than what is in the selection, and then the selection seems highlighted.

Tip



If you use moving keys you can move the selection or modify its size by one pixel step. If you use it in combination with **Shift** you can move it by a 25 pixel step.

Figure 14.11 Sensitive selection areas

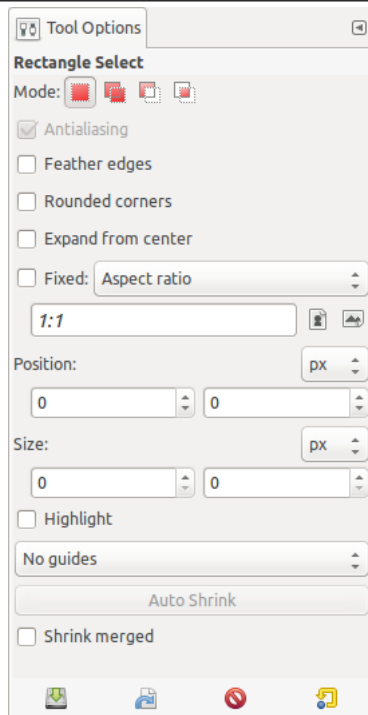


Display of all possible pointers in function of their localization with respect to the selection area.

After creating and modifying the selection, you will have to exit this editing mode (and commit any changes). You can do this with a single click inside the selection or by pressing the **Enter** key. Or you can just use a non-selection tool and, for example, fill or paint the selection.

14.2.2.4 Tool Options

Figure 14.12 Tool Options for the Rectangle Select tool



Normally, tool options are displayed in a window attached under the Toolbox as soon as you activate a tool. If they are not, you can access them from the image menu bar through Windows → Dockable Windows → Tool Options which opens the option window of the selected tool.

Note



See [Selection Tools](#) for help with options that are common to all these tools. Only options that are specific to this tool are explained here.

Mode; Antialiasing; Feather edges Common select options.

Rounded corners If you enable this option, a slider appears. You can use this to adjust the radius that is used to round the corners of the selection.

Expand from center If you enable this option, the point the selection is started by pressing the mouse button is used as center of the selected area.

Fixed This menu allows you the option of constraining the shape of the rectangle in different ways.

Aspect ratio This option allows you to design and resize the selection while keeping the aspect ratio fixed and written within the relevant box. By default the ratio is 1:1 (so we have a square) but it can be changed. With the two little landscape and picture icons, you can invert this ratio.

Width With this choice you can fix the width of the selection.

Height With this choice you can fix the height of the selection.

Size With this choice you can fix the width and height of the selection.

Position These two text fields contain the current horizontal and vertical coordinates of the upper left corner of the selection. You can use these fields to adjust the selection position precisely.

Size These two text fields contain the current width and height of the the selection. You can use these fields to adjust the selection size precisely.

Highlight If you enable this option, the selected area is emphasized by a surrounding mask to make visual selection much easier.

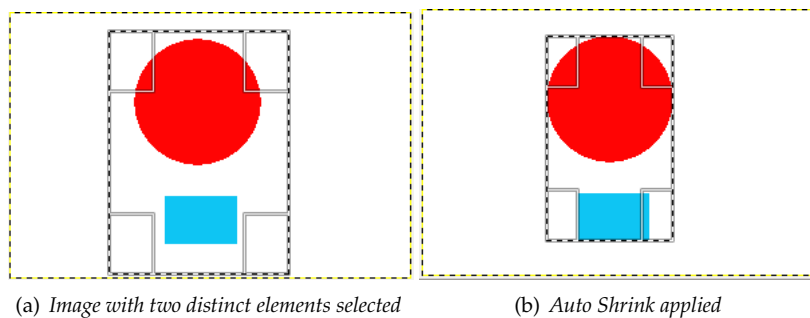
Guides With this menu you can select the type of guides that is shown within the selection to make the creation of a selection easier, respecting *Photo composition rules*.

Six options are available:

- No Guides
- Center lines
- Rule of thirds
- Rule of fifths
- Golden sections
- Diagonal lines

Auto Shrink Selection This option is active when a rectangle selection is drawn. Clicking on the Auto Shrink Selection button will make the selection automatically shrink to the nearest rectangular shape including elements in the selection. The algorithm for finding the best rectangle to shrink to is “intelligent”, which in this case means that it sometimes does surprisingly sophisticated things, and sometimes does surprisingly strange things. In any case, if the region that you want to select has a solid-colored surround, auto-shrinking will always pick it out correctly. Note that the resulting selection does not need to have the same shape as the one you sweep out.

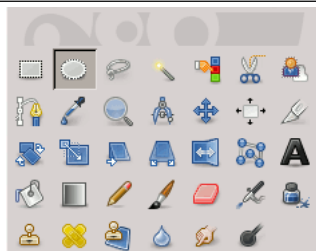
Figure 14.13 Auto Shrink example



Shrink merged If Sample Merged is also enabled, then Auto Shrink will use the pixel information from the visible display of the image, rather than just from the active layer. For further information regarding Sample Merge, see the glossary entry [Sample Merge](#).

14.2.3 Ellipse Selection

Figure 14.14 Ellipse Select icon in the Toolbox




The Ellipse Selection tool is designed to select circular and elliptical regions from an image, with high-quality anti-aliasing if you want it. For information on selections and how they are used in GIMP see [Selections](#); for information on features common to all selection tools see [Selection Tools](#).

This tool is also used for rendering a circle or ellipse on an image. To render a filled ellipse, create an elliptical selection, and then fill it using the **Bucket Fill tool**. To create an elliptical outline, the simplest and most flexible approach is to create an elliptical selection and then **stroke** it. However, the quality of anti-aliasing with this approach is rather crude. A higher quality outline can be obtained by creating two elliptical selections with different sizes, subtracting the inner one from the outer one; however this is not always easy to get right. The command `Select → Border...` makes it easy.

14.2.3.1 Activating the tool

You can access the Ellipse Selection Tool in different ways:

- From the image menu bar `Tools → Selection Tools → Ellipse Select`;
- By clicking on the tool icon  in the ToolBox,
- By using the keyboard shortcut **E**.

14.2.3.2 Key modifiers

Note



See **Selection Tools** for help with modifier keys that affect all these tools in the same way. Only effects options that are specific to this tool are explained here.

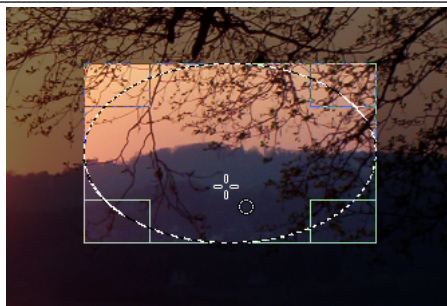
Ctrl Pressing the key after starting your selection, and holding it down until you are finished, causes your starting point to be used as the center of the selected ellipse, instead of a corner of the rectangle that may contain it. Note that if you press the **Ctrl** key *before* starting to make the selection, the resulting selection will be subtracted from the existing selection.

Shift Pressing the **Shift** key after starting your selection, and holding it down until you are finished, constrains the selection to be a circle. Note that if you press the **Shift** key *before* starting to make the selection, the resulting selection will be added to the existing selection.

Ctrl-Shift Pressing both keys combines the two effects, giving you a circular selection centered on your starting point.

14.2.3.3 Tool handling

Figure 14.15 Example of Ellipse Selection.

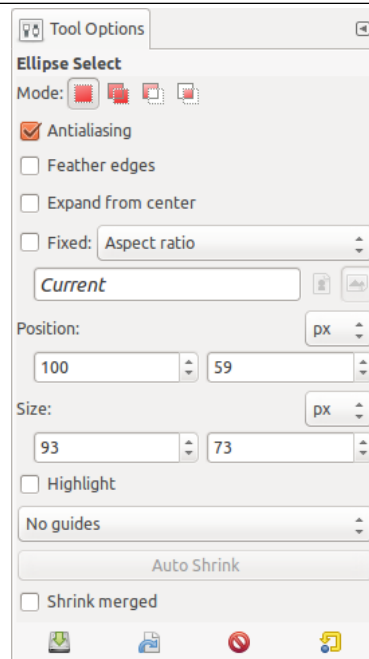


When this tool is selected the mouse pointer comes with a circle icon as soon as it is over the image. A drag-and-drop allows you to get an ellipse (or a circle) within a rectangular box. When the mouse button is relaxed, a dotted line (“marching ants”) outlines the elliptic selection. It’s not necessary to adjust the selection with care; you can resize it easily later.

When the pointer is moving on the canvas, the pointer and selection aspects change. You can change the size of the selection by using handles. See [Tool handling](#) within the rectangular chapter.

14.2.3.4 Options

Figure 14.16 Tool Options for the Ellipse Select tool



Normally, tool options are displayed in a window attached under the Toolbox as soon as you activate a tool. If they are not, you can access them from the image menu bar through `Windows → Dockable Windows → Tool Options` which opens the option window of the selected tool.

Note



See [Selection Tools](#) for help with options that are common to all these tools. Only options that are specific to this tool are explained here.

Modes; Antialiasing; Feather edges Common select options.

All other options All these options work exactly the same way, they were described for the rectangular selection already. See for Section [14.2.2.4](#) details.

14.2.4 Free Selection (Lasso)

Figure 14.17 Free Selection icon in the Toolbox



The Free Selection tool, or Lasso, lets you create a selection by drawing it with the pointer.

Since GIMP-2.6, you can use it in two ways. First create the *starting point* clicking on your image. Then,

- Maintaining the mouse button pressed (i.e click-and-drag), drag to draw a free hand selection. When end point comes superimposed on the starting point, release the mouse button to close the selection.
If you click on the end point, it turns accompanied by a moving cross. Then, dragging enlarges the shape.
- Or release the mouse button and drag to draw a polygonal selection. When end point comes superimposed on the starting point, click to close the selection.
Press the **Ctrl** keyboard key and click on the end point: moving the mouse pointer forces moving angles to 15°; so, you can draw horizontal or vertical lines easily.

In both cases, double clicking on the end point closes the selection with a straight line.

In polygonal mode, this selection is a *preliminary selection*; ants are marching, but the small yellow circle is still present: you can copy the selection and, pressing the **Backspace** key, you return to the previous selection step (re-open the shape), and you can edit the selection.

Press **Enter** or double click inside the shape to *validate the selection*.

Pressing and releasing the mouse pointer allows you to mix free hand *segments* and polygonal segments. You can go outside the edge of the image display and come back in if you want to.

The Lasso is often a good tool to use for “roughing in” a selection; it is not so good for precise definition. Experienced users find that it is often convenient to begin with the lasso tool, but then switch to **QuickMask** mode for detail work.

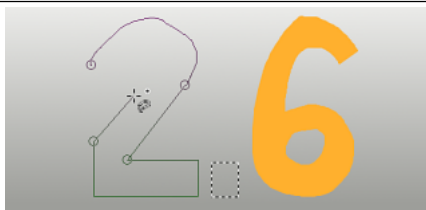
For information on selections and how they are used in GIMP see **Selections**. For information on features common to all selection tools see **Selection Tools**.

Note




The Free Selection tool is much easier to use with a tablet than with a mouse.

Figure 14.18 Mixing free hand segments and polygonal segments



14.2.4.1 Activating the tool

You can access the Lasso Tool in different ways:

- From the image menu bar Tools → Selection Tools → Free Select,
- by clicking on the tool icon  in the ToolBox,
- by using the keyboard shortcut F.

14.2.4.2 Key modifiers

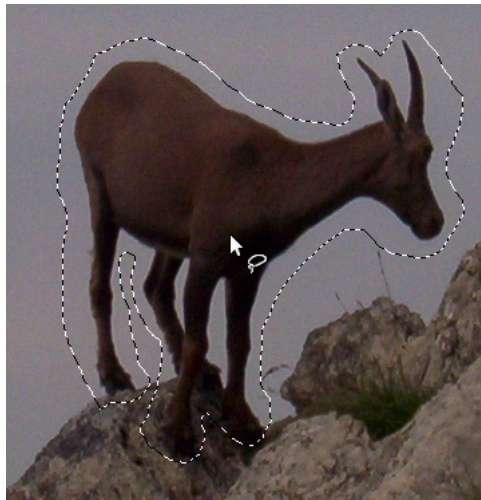
The Free Select tool has key modifiers that affect all selection tools in the same way. See [Selection Tools](#) for help with these.

Backspace returns to previous selection step (removes last selection segment), **Escape** cancels all selection segments.

14.2.4.3 Tool handling

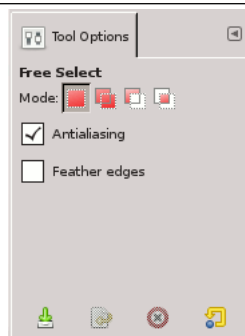
To move the selection, see [Moving selections](#).

Figure 14.19 Rough selection with the Free Selection tool.



14.2.4.4 Options

Figure 14.20 Tool Options for the Lasso tool



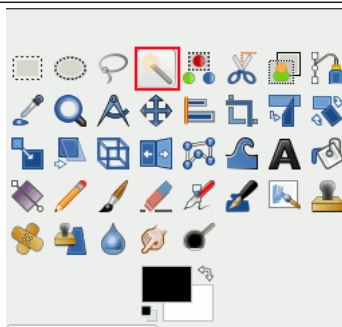
Normally, tool options are displayed in a window attached under the Toolbox as soon as you activate a tool. If they are not, you can access them from the image menu bar through Windows → Dockable Windows → Tool Options which opens the option window of the selected tool.

The Free Select tool has no special tool options, only the ones that affect all selection tools in the same way. See [Selection Tools](#) for help with these.

Since GIMP-2.10.12, selection modes work differently. Marching ants come with a continuous line, meaning that the selection is not validated yet and that you can still change the selection shape (mouse pointer comes with the Move icon). But you can't use (holding it pressed) **Shift, Ctrl...** yet. You have to hit the **Enter** key. Then you can use (holding them pressed) **Shift** to add a selection, **Ctrl** to subtract a selection, **Shift + Ctrl** to intersect two selections. When you are satisfied with your changes, hit **Enter** key to validate the selection.

14.2.5 Fuzzy selection (Magic wand)

Figure 14.21 Magic Wand tool icon in the Toolbox



The Fuzzy Select (Magic Wand) tool is designed to select areas of the current layer or image based on color similarity.


When using this tool, it is very important to pick the right starting point. If you select the wrong spot, you might get something very different from what you want, or even the opposite.

The Wand is a good tool for selecting objects with sharp edges. It is fun to use, so beginners often start out using it a lot. You will probably find, however, that the more you use it, the more frustrated you become with the difficulty of selecting exactly what you want, no more, no less. More experienced users find that the [Path](#) and [Color Select](#) tools are often more efficient, and use the Wand less. Still, it is useful for selecting an area within a contour, or touching up imperfect selections. It often works very well for selecting a solid-colored (or nearly solid-colored) background area.

Note that as the selected area expands outward from the center, it does not only propagate to pixels that touch each other: it is capable of jumping over small gaps, depending on Threshold option. To increase/decrease Threshold, during the use of Fuzzy Selection, after the first button-press, dragging the pointer downward (or to the right) or upward (or to the left).

14.2.5.1 Activating the tool

You can access the Magic Wand Tool in different ways:

- From the image menu bar Tools → Selection Tools → Fuzzy Select,
- by clicking on the tool icon  in the ToolBox,
- by using the keyboard shortcut **U**.

14.2.5.2 Key modifiers (Defaults)

The Fuzzy Select tool does not have any special key modifiers, only the ones that affect all selection tools in the same way. See [Section 14.2.1](#) for help with these.

14.2.5.3 Tool handling

Figure 14.22 Using Magic Wand tool: selected pixels are contiguous

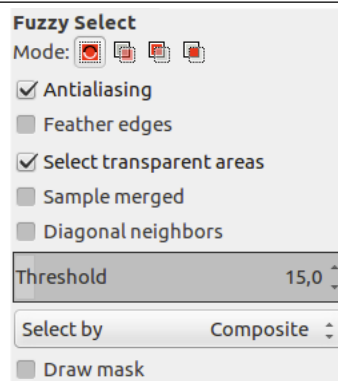


It starts selecting when you click at a spot in the image, and expands outwards like water flooding low-lying areas, selecting contiguous pixels whose colors are similar to the starting pixel. You can control the threshold of similarity by dragging the mouse downward or to the right: the farther you drag it, the larger you get the selected region. And you can reduce the selection by dragging upwards or to the left.

You can move the selection outline using **Alt** + arrow keys.

14.2.5.4 Options

Figure 14.23 Tool Options for the Magic Wand tool



Normally, tool options are displayed in a window attached under the Toolbox as soon as you activate a tool. If they are not, you can access them from the image menu bar through **Windows** → **Dockable Windows** → **Tool Options** which opens the option window of the selected tool.

Note



See [Selection Tools](#) for help with options that are common to all these tools. Only options that are specific to this tool are explained here.

Mode; Antialiasing; Feather edges Common select options.

Finding Similar Colors These options affect the way the Magic Wand expands the selection out from the initial point.

Select Transparent Areas This option gives the Magic Wand the ability to select areas that are completely transparent. If this option is not checked, transparent areas will never be included in the selection.

Sample Merged This option becomes relevant when you have several layers in your image, and the active layer is either semi-transparent or is set to another Layer Mode than Normal. If this is the case, the colors present in the layer will be different from the colors in the composite image. If the “Sample Merged” option is unchecked, the wand will only react to the color in the active layer when it creates a selection. If it is checked it will react to the composite color of all visible layers. For further information, see the glossary entry [Sample Merged](#).

Diagonal Neighbors When activated, the tool considers diagonally neighboring pixels as connected when calculating the affected area. In other words, instead of looking at the four orthogonal neighbors of each pixel, it looks at all eight pixels

Figure 14.24 Example for Diagonal Neighbors

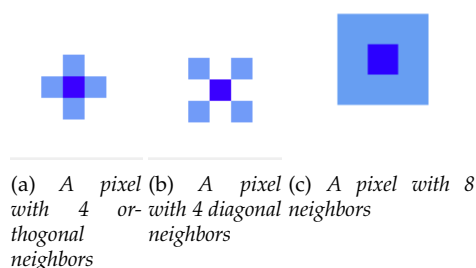
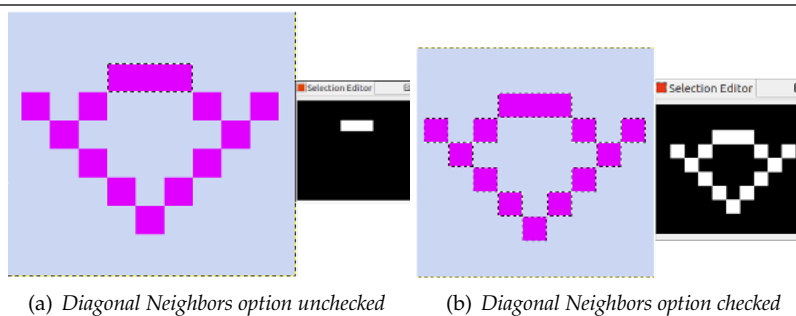


Figure 14.25 Example for Diagonal Neighbors option applied



Threshold This slider determines the range of colors that will be selected at the moment you click the pointer on the initial point, before dragging it: the higher the threshold, the larger the resulting selection. After the first button-press, dragging the pointer downward or to the right will increase the size of the selection; dragging upward or to the left will decrease it. Thus, you have the same set of possibilities regardless of the Threshold setting: what differs is the amount of dragging you have to do to get the result you want.

Select by This option determines which component of the image GIMP uses to calculate the similarity in color.

You can choose from Composite, Red, Green, Blue, HSV Hue, HSV Saturation, HSV Value, LCh Lightness, LCh Chroma, LCh Hue, and Alpha.

Draw Mask This option is only an help for selection. Selected areas marked with marching ants may not be evident when selecting with Fuzzy select or Magic wand. If this option is checked, selected areas will be filled with a magenta color as long as you keep pressing on the mouse left button, and this mask will disappear as soon as you release this button.

Figure 14.26 Example for Draw mask option applied

(a) Fuzzy Select used with Draw Mask option unchecked
 (b) Fuzzy Select used with Draw Mask option checked, left mouse button not released yet.


14.2.6 Select By Color

Figure 14.27 Select by Color tool icon in the Toolbox

The Select by Color tool is designed to select areas of an image based on color similarity. It works a lot like the Fuzzy Select tool (“Magic Wand”). The main difference between them is that the Magic Wand selects *contiguous* regions, with all parts connected to the starting point by paths containing no large gaps; while the Select by Color tool selects all pixels that are sufficiently similar in color to the pixel you click on, regardless of where they are located.

14.2.6.1 Activating the tool

You can access the Select by Color Tool in different ways:

- From the image menu bar Tools → Selection Tools → By Color Select,
- by clicking on the tool icon  in the ToolBox,
- by using the keyboard shortcut Shift -O.

14.2.6.2 Key modifiers (Defaults)

The select by color tool does not have any special key modifiers, only the ones that affect all selection tools in the same way. See [Selection Tools](#) for help with these.

14.2.6.3 Handling tool

Figure 14.28 Using Select by Color tool: selected pixels are not only contiguous

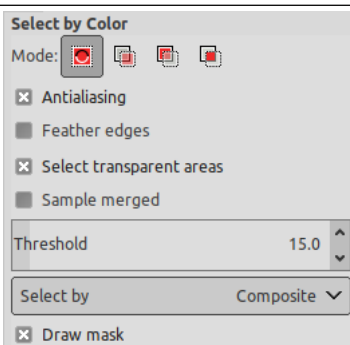


As with fuzzy tool, the selection starts as soon as you click and the reference is the first clicked pixel. If you click and drag, you can change the threshold by the same way as with the fuzzy tool.

You can move the selection outline with the arrow keys, not with the mouse.

14.2.6.4 Options

Figure 14.29 Tool Options for the Select by Color tool



Normally, tool options are displayed in a window attached under the Toolbox as soon as you activate a tool. If they are not, you can access them from the image menu bar through Windows → Dockable Windows → Tool Options which opens the option window of the selected tool.

Note



See [Selection Tools](#) for help with options that are common to all these tools. Only options that are specific to this tool are explained here.

Select transparent areas, Sample merged, Draw mask These three options work exactly the same way they were described for the fuzzy selection already. See for Section [14.2.5.4](#) details.

14.2.7 Intelligent Scissors

Figure 14.30 Intelligent Scissors tool icon in the Toolbox



The Intelligent Scissors tool is an interesting piece of equipment: it has some features in common with the Lasso, some features in common with the Path tool, and some features all its own. It is useful when you are trying to select a region defined by strong color-changes at the edges. To use the Scissors, you click to create a set of "control nodes", also referred to as anchors or control points, at the edges of the region you are trying to select. The tool produces a continuous curve passing through these control nodes, following any high-contrast edges it can find. If you are lucky, the path that the tool finds will correspond to the contour you are trying to select.

Unfortunately, there seem to be some problems with the edge-following logic for this tool, with the result that the selections it creates tend to be pretty crude in a lot of cases. A good way to clean them up is to switch to **QuickMask** mode, and use paint tools to paint in the problematic parts. On the whole, most people find the Path tool to be more useful than the Scissors, because, even though it does not have the intelligent edge-finding capability, the paths it produces persist until you delete them, and can be altered at any time.

14.2.7.1 Activating the tool

You can access the Intelligent Scissors Tool in different ways:

- From the image menu bar Tools → Selection Tools → Intelligent Scissors,

- by clicking on the tool icon  in the ToolBox,

- by using the keyboard shortcut **I**.

14.2.7.2 Key modifiers

The default behavior of the **Shift**, **Ctrl**, and **Alt** keys is described in Section 14.2.1.1 for all selection tools.

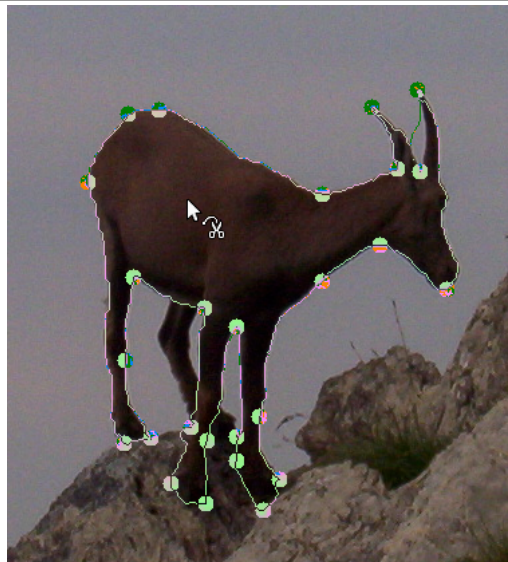
There is, however, one key modifier that has a special behavior if you use it while editing a selection, that is *after* you have added the first node:

Shift By default, the *auto-edge snap feature* is enabled: whenever you click and drag the mouse pointer, the Scissors tool finds the point of the maximal gradient (where the color change is maximal) for placing a new control node or moving an existing node.




Holding down this key while clicking and dragging disables this feature, and the control node will be placed at the position of the mouse pointer.

Backspace removes last segment drawn, **Escape** cancels all selection segments.

14.2.7.3 Tool handling

Figure 14.31 Using Intelligent Scissors

Each time you left-click with the mouse, you create a new control point, which is connected to the last control point by a curve that tries to follow edges in the image. To finish, click on the first point (the cursor changes to indicate when you are in the right spot). You can adjust the curve by dragging the control nodes, or by clicking to create new control nodes. When you are satisfied, click anywhere inside the curve to convert it into a selection.

As said above when you click with this tool you drop points. The selection boundary is driven by these control points. During creation you can move each one by clicking and dragging, except the first and the last one. The selection is closed when you are clicking the last point over the first one. When the selection is closed the pointer shape changes according to its position: inside , on the boundary , and outside . You can adjust the selection creating new points by clicking on the boundary or by moving each control points (merged first and last point). The selection is validated when you click inside.

You have to notice that you can get only one selection; if you create a second selection, the first one is erased when you validate the second one.

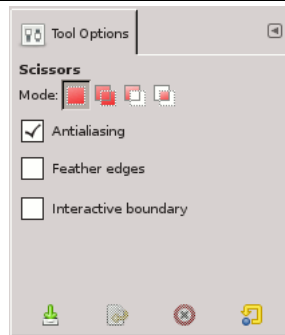
Warning

Be sure not to click inside the curve until you are completely done adjusting it. Once you have converted it into a selection, undoing takes you back to zero, and you will have to start constructing the curve again from scratch if you need to change it. Also be sure not to switch to a different tool, or again all of your carefully created control nodes will be lost. (But you still can transform your selection into a path and work it with the Path tool.)

To move the selection, see [Moving selections](#).

14.2.7.4 Options

Figure 14.32 Tool Options for the Intelligent Scissors



Normally, tool options are displayed in a window attached under the Toolbox as soon as you activate a tool. If they are not, you can access them from the image menu bar through Windows → Dockable Windows → Tool Options which opens the option window of the selected tool.

Modes; Antialiasing; Feather edges

Note



See [Selection Tools](#) for help with options that are common to all these tools. Only options that are specific to this tool are explained here.

Interactive boundary If this option is enabled, dragging a control node during placement will indicate the path that will be taken by the selection boundary. If it is not enabled, the node will be shown connected to the previous node by a straight line while you are dragging it around, and you won't see the resulting path until you release the pointer button. On slow systems, if your control nodes are far apart, this may give a bit of a speed-up.

14.2.8 Foreground Select


Figure 14.33 The “Foreground Select” tool in the Toolbox



This tool lets you extract the foreground from the active layer or from a selection. With GIMP-2.10, selection refinement has been improved. After the selection is made, with its marching ants, you can copy-paste or click-and-drag it to another image used as background, and, inverting the selection, you can make changes in background.

14.2.8.1 Activating the Tool

You can activate the Foreground Select tool in two ways:

- by clicking on the tool icon  in the Toolbox,
- through Tools → Selection Tools → Foreground Select in the image menu.
- This tool has no shortcut, but you can set one using Edit → Preferences → Interface → Configure Keyboard Shortcuts → Tools → Foreground Select

14.2.8.2 Directions for use

Let us start with an object distinctly different from background, not needing to be refined.

1. *Roughly select the foreground* you want to extract. When you select this tool, the mouse pointer goes with the lasso icon. It actually works like the Free Select tool. Select as little as possible from the background.

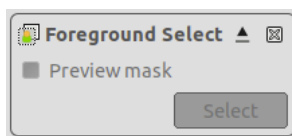
When the mouse pointer comes over line beginning, a small yellow circle appears: release mouse button to close selection. While selecting, click-and-drag draws a fuzzy line, drag only draws a straight line.

If the mouse pointer doesn't cover start point, double clicking closes selection with a straight line.



The selection is closed.

As soon you click to start drawing, a small window pops up:



For the moment, only a little *cross* is active, allowing to quit: returns to the original image.

2. Press **Enter** to create the *mask*:



The mouse pointer goes now with the Paint-brush icon. The dark blue area (this color can be changed) is for background. The light blue area covers the zone you have selected, on which you will paint to extract foreground. It contains the *foreground area* and a *small part of background*. Outside the selected area, the dark blue area is named *Unknown pixels area*.

Options in the small window become active:

- A Preview mask checkbox that toggles displaying a preview of the foreground extraction status.
 - A Select button that will be used to create the extraction after marking the foreground.
3. *Draw a line through the foreground*: using the default selected paintbrush, whose size can be changed in options, draw a continuous line in the selected foreground going over colors which will be kept for the extraction. The color used to draw the line is of no importance; not using the same color as foreground is better. Be careful not painting background pixels.

With this one-color object distinctly different from background, a few strokes are enough:



4. *Toggle preview* to verify result.



Note



This Preview mask is a mask: you can draw directly on it and see result immediately.

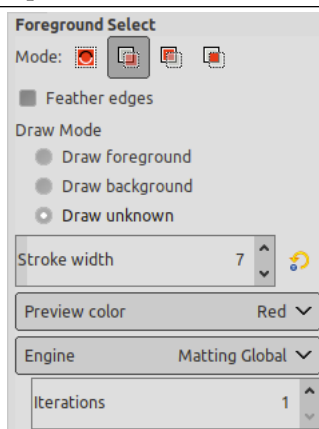
5. Try Matting Levin engine that may improve result.



6. When you are satisfied with result, click on Select button to get the selection of the foreground with its marching ants.

14.2.8.3 Options

Figure 14.34 “Foreground Select” tool options



Normally, tool options are displayed in a window attached under the Toolbox as soon as you activate a tool. If they are not, you can access them from the image menu bar through Windows → Dockable Windows → Tool Options which opens the option window of the selected tool.

Mode; Feather edges

Note



See [Selection Tools](#) for help with options that are common to all these tools. Only options that are specific to this tool are explained here.

Draw mode Draw foreground: to draw what will be foreground.

Draw background: to draw what will be background.

Draw unknown: to add pixels that are in background to your selection.

Stroke width The size of the brush.

Preview mode

- Color (default): you can adapt the color of the preview to your image, clicking on the color swatch.
- Grayscale : new in GIMP-2.10.14, to see the resulting mask in black and white. This preview is similar to a layer mask. It is useful in images where FG color and BG color are not very different and limit between them nor very evident.

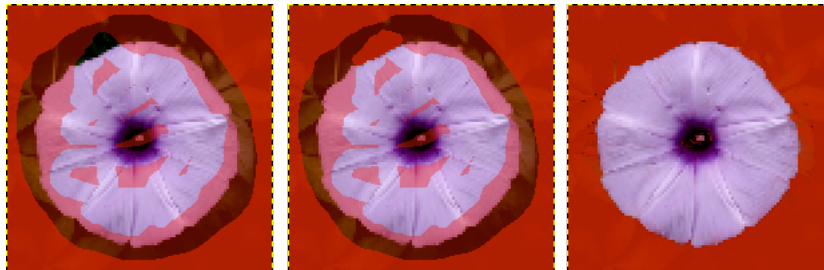
Engine Work with Matting global(default) and improve result with Matting Levin.

Iterations Default is 1. Repeating algorithm may improve result.

14.2.8.4 Refining Foreground Extraction

In most images, foreground is not distinctly different from background. Refining selection allows you now to extract these foregrounds. Procedure steps are the same as above, but, during drawing foreground, you will often toggle Preview, use Zoom (+ key), Draw background to delete unwanted background extraction areas. You can also work directly on Preview mask.

Figure 14.35 Example for Draw background



On the left: drawing foreground ill-advisedly went over background area: a part of background will be included in foreground selection!

In middle: Draw background option is checked: draw on inclusion and unwanted pixels.

On the right: unwanted selected pixels in background are no longer in foreground selection.

Figure 14.36 Example for Draw unknown

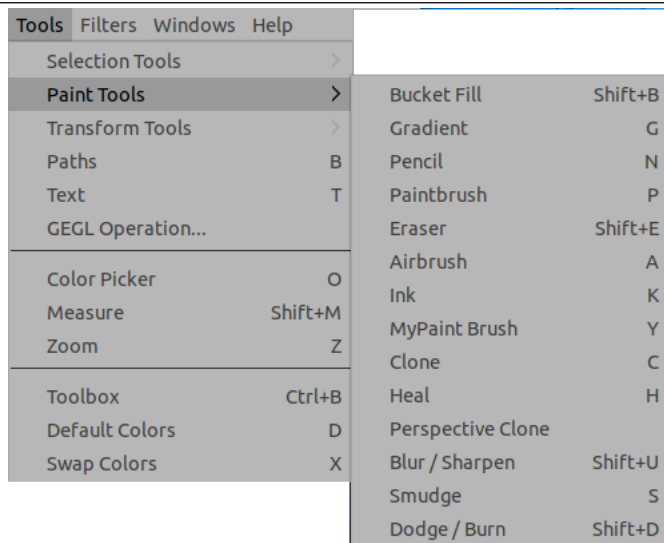


On the left: the selection left a small part of foreground unselected, in unknown pixels area.

On the right: with Draw unknown option checked, draw on unselected pixels. They are now selected.

14.3 Paint Tools

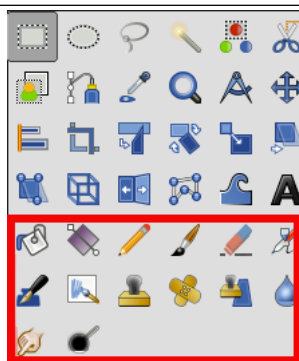
Figure 14.37 The Paint Tools (Tools menu)



14.3.1 Common Features

The GIMP Toolbox includes thirteen “paint tools”, all grouped together at the bottom (in the default arrangement).

Figure 14.38 The Paint Tools (Tools Box)



The feature they all have in common is that all of them are used by moving the pointer across the image display, creating brush-strokes. Four of them

- the **Pencil**,
- the **Paintbrush**,
- the **Airbrush** and
- the **Ink tool**

and **MyPaint brushes**, a new feature in Gimp-2.10.6, behave like the intuitive notion of “painting” with a brush. Pencil, Paintbrush, and Airbrush are called “basic painting tools” or **brush tools**.

The other tools use a brush to modify an image in some way rather than paint on it:

- the **Bucket Fill** fills with color or pattern;
- the **Gradient** fills with gradients;

- the **Eraser** erases;
- the **Clone tool** copies from a pattern, or image;
- the **Perspective Clone** tool copies into a changed perspective;
- the **Heal tool** corrects small defects;
- the **Convolve tool** blurs or sharpens;
- the **Smudge tool** smears;
- and the **Dodge/Burn tool** lightens or darkens.

The advantages of using GIMP with a tablet instead of a mouse probably show up more clearly for brush tools than anywhere else: the gain in fine control is invaluable. These tools also have special “Pressure sensitivity” options that are only usable with a tablet.

In addition to the more common “hands-on” method, it is possible to apply paint tools in an automated way, by creating a selection or path and then “stroking” it. You can choose to stroke with any of the paint tools, including nonstandard ones such as the Eraser, Smudge tool, etc., and any options you set for the tool will be applied. See the section on **Stroking** for more information.

14.3.1.1 Key modifiers

Ctrl Holding down the **Ctrl** key has a special effect on every paint tool. For the Pencil, Paintbrush, Airbrush, Ink, and Eraser, it switches them into “color picker” mode, so that clicking on an image pixel causes GIMP’s foreground to be set to the active layer’s color at that point (or, for the Eraser, GIMP’s background color). For the Clone tool, the **Ctrl** key switches it into a mode where clicking sets the reference point for copying. For the Convolve tool, the **Ctrl** key switches between blur and sharpen modes; for the Dodge/Burn tool, it switches between dodging and burning.

Shift Holding down the **Shift** key has the same effect on most paint tools: it places the tool into *straight line* mode. To create a straight line with any of the paint tools, first click on the starting point, *then* press the **Shift** key. As long as you hold it down, you will see a thin line connecting the previously clicked point with the current pointer location. If you click again, while continuing to hold down the **Shift** key, a straight line will be rendered. You can continue this process to create a series of connected line segments.

Ctrl-Shift Holding down both keys puts the tool into *constrained straight line* mode. This is similar to the effect of the **Shift** key alone, except that the orientation of the line is constrained to the nearest multiple of 15 degrees. Use this if you want to create perfect horizontal, vertical, or diagonal lines.

14.3.1.2 Tool Options

Figure 14.39 Tool options shared by paint tools



Many tool options are shared by several paint tools: these are described here. Options that apply only to one specific tool, or to a small number of tools, are described in the sections devoted to those tools.

Mode The Mode drop-down list provides a selection of paint application modes. As with the opacity, the easiest way to understand what the Mode setting does is to imagine that the paint is actually applied to a layer above the layer you are working on, with the layer combination mode in the Layers dialog set to the selected mode. You can obtain a great variety of special effects in this way. The Mode option is only usable for tools that can be thought of as adding color to the image: the Pencil, Paintbrush, Airbrush, Ink, and Clone tools. For the other paint tools, the option appears for the sake of consistency but is always grayed out. A list of modes can be found in Section 8.2.

In this list, some modes are particular and are described [below](#).

Opacity The Opacity slider sets the transparency level for the brush operation. To understand how it works, imagine that instead of altering the active layer, the tool creates a transparent layer above the active layer and acts on that layer. Changing Opacity in the Tool Options has the same effect that changing opacity in the Layers dialog would have in the latter situation. It controls the “strength” of all paint tools, not just those that paint on the active layer. In the case of the Eraser, this can come across as a bit confusing: it works out that the higher the “opacity” is, the more transparency you get.

Brush The brush determines how much of the image is affected by the tool, and how it is affected, when you trace out a brushstroke with the pointer. GIMP allows you to use several different types of brushes, which are described in the [Brushes](#) section. The same brush choices are available for all paint tools except the Ink tool, which uses a unique type of procedurally generated brush. The colors of a brush only come into play for tools where they are meaningful: the Pencil, Paintbrush, and Airbrush tools. For the other paint tools, only the intensity distribution of a brush is relevant.

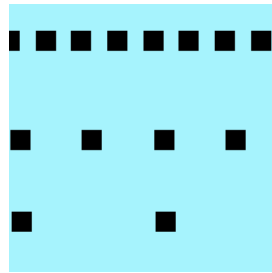
Size This option lets you to modify precisely the size of the brush. You can use the arrow keys to vary by ± 0.01 or the Page-Up and Page-Down keys to vary by ± 1.00 . You can obtain the same result if you have correctly set your mouse-wheel in the Preferences. See [How to vary the size of a brush](#)

Aspect Ratio This determines the ratio between the height and the width of the brush. The slider is scaled from -20.00 to 20.00 with the default value set to 0.00. A negative value from 0.00 to -20 will narrow the height of the brush while a positive value between 0.00 and 20.00 indicates the narrowing rate of the width of the brush.

Angle This option makes the brush turn round its center. This is visible if the brush is not circular or made from a rotated figure.

Spacing This option sets the distance between the brush marks in a stroke.

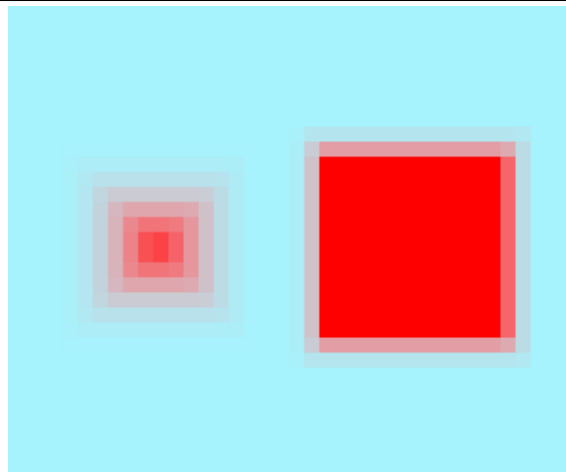
Figure 14.40 Spacing option



Different spacings

Hardness Modifies the size of the brush hard center.

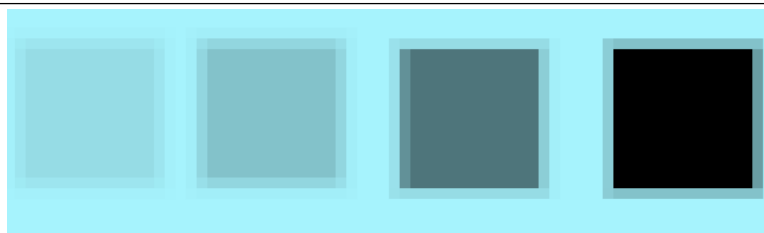
Figure 14.41 Hardness option



On the left: hardness=50 On the right: hardness=100.

Force Modifies gain.

Figure 14.42 Force option



Force is 10%, 20%, 40%, 80%.

Dynamics Brush dynamics let you map different brush parameters to several input dynamics. They are mostly used with graphic tablets, but some of them are also usable with a mouse.

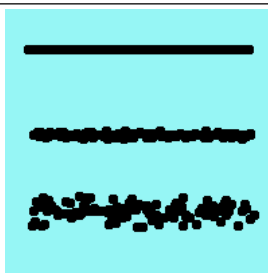
You can read more about dynamics in [Dynamics](#)

When stroking paths and selections using a paint tool there is an option to select “Emulate brush dynamics”. That means that when you stroke, brush pressure and velocity are varying along the length of the stroke. Pressure starts with zero, ramps up to full pressure and then ramps down again to no pressure. Velocity starts from zero and ramps up to full speed by the end of the stroke.

Dynamics Options These options are described in [Dynamics Options](#)

Apply Jitter You know “spacing” in brush strokes: strokes are made of successive brush marks which, when they are very near, seem to draw a continuous line. Here, instead of being aligned brush marks are scattered over a distance you can set with the Amount slider.

Figure 14.43 “Jitter” example



From top to bottom: without jitter, jitter = 1, jitter = 4.

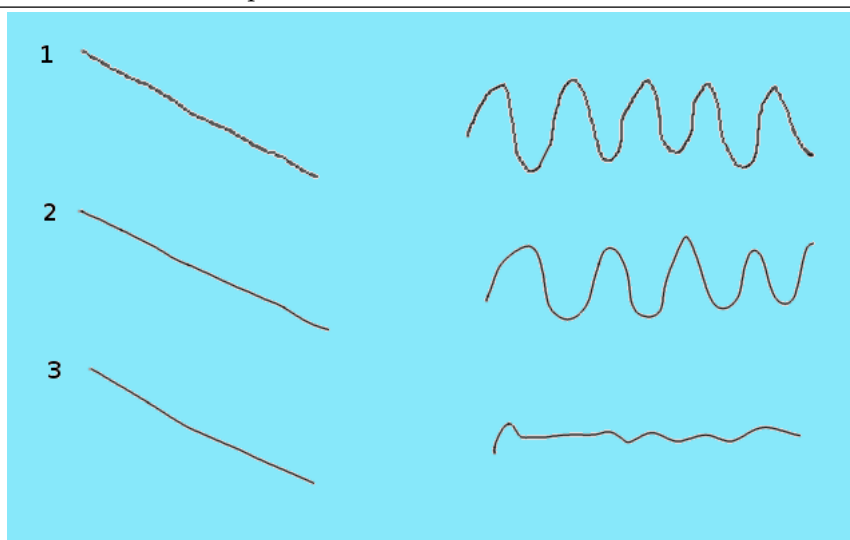
Jitter is also available in the Paint Dynamic Editor where you can connect jitter to the behavior of the brush.

Smooth Stroke This option doesn’t affect the rendering of the brush stroke but its “shape”. It takes away the wobbles of the line you are drawing. It makes drawing with a mouse easier.

When this option is checked, two setting areas appear, Quality and Weight. You can change the default values to adapt them to your skill.

High weight values rigidifies the brush stroke.

Figure 14.44 “Smooth Stroke” example



Trying to draw a straight line and a sine curve with the mouse. 1 : option unchecked 2 : default values 3 : maximum values

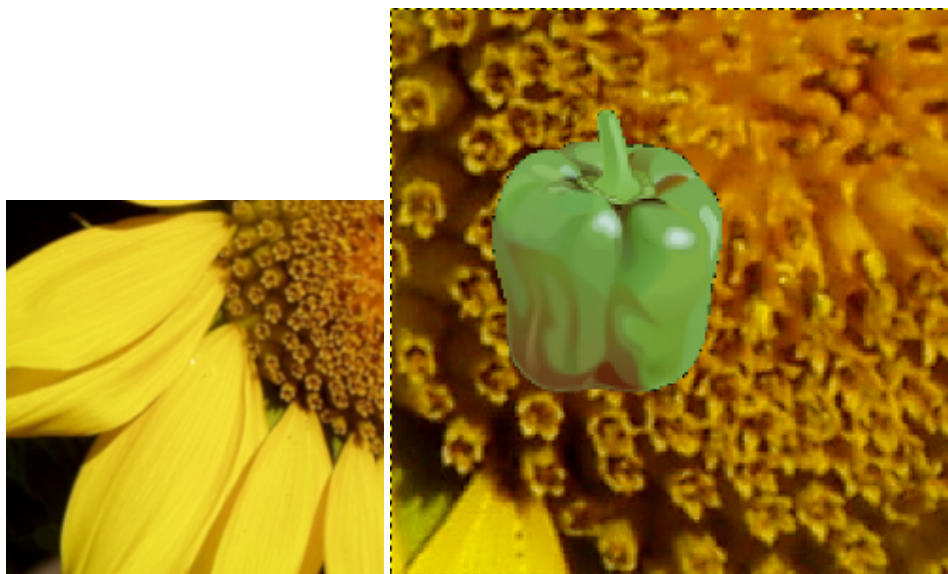
Lock brush size to view When you are working on an image that is bigger (in pixels) than your screen, you have to zoom in and out a lot. This option allows a very natural “iterative refinement” process

with no need to repeatedly ask the application to change brush size as you go between the broad strokes and the detailing.

If the brush size is relative to the canvas (option unchecked), zooming in makes the brush zoomed also and it appears larger (takes up more pixels on the screen). If you're working with a 300 pixels radius brush and you zoom in from 12% to 100%, the brush is now half the size of your screen! So you have to shrink the brush back down.

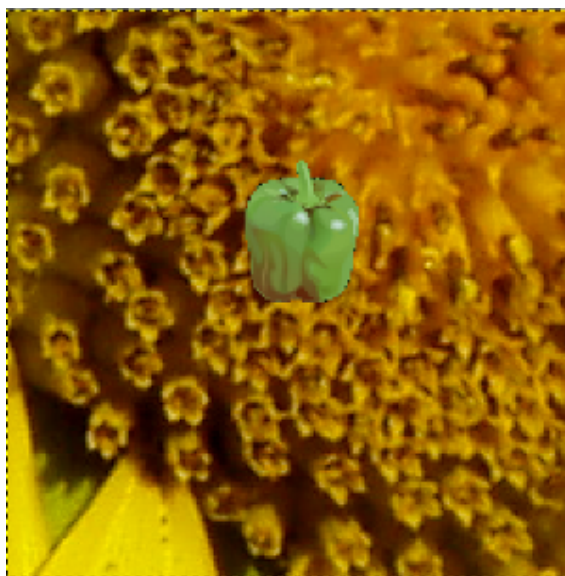
If the brush size is relative to the screen (option checked), then when you zoom in, the size of the displayed brush doesn't change, it looks smaller and so you can work on tiny details.

Figure 14.45 Lock brush example



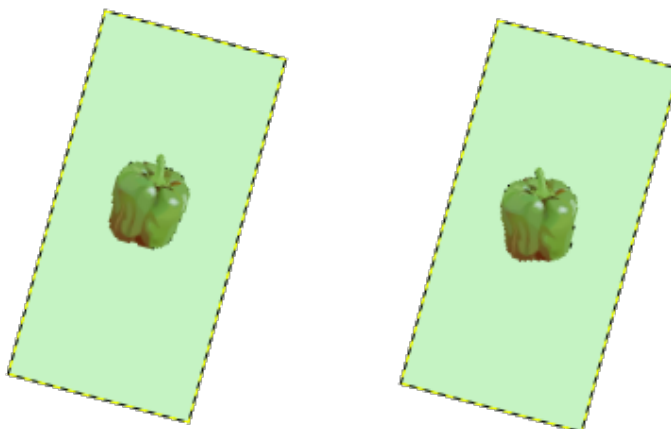
(a) This image is the screenshot of a small part of a TIFF image bigger than my screen. Here, GIMP displays this TIFF image at 50% zoom, so the whole image is visible. The option is not checked, brush size in toolbox is 100 pixels high.

(b) Screenshot: zoom 200. The option is not checked. We paint with pencil and the pepper brush that is 100 pixels high in toolbox: displayed brush stroke is 200 pixels high.



(c) Screenshot: zoom 200. The option is checked. We paint with pencil and the pepper brush that is 100 pixels high in toolbox: displayed brush stroke is 100 pixels high.

"Lock brush to view" can also be used to lock brush to view rotation:

Figure 14.46 Lock brush to view rotation example

(a) Screenshot. Here, the option is unchecked (b) Same thing but the option is checked: the and we use View → Flip and Rotate → Rotate brush is locked to the original, not rotated view 15° clockwise: brush stroke is rotated. and brush stroke is not rotated.

Incremental Applies the effect incrementally as the mouse pointer moves.

The incremental checkbox does not seem to work as everyone expects. If it is deactivated (the default value) the maximum effect of a single stroke is determined by the opacity set in the opacity slider. If the opacity is set to less than 100, moving the brush over the same spot will increase the opacity if the brush is lifted in the meantime. Painting over with the same stroke has no such effect. If Incremental is active the brush will paint with full opacity independent of the slider's setting. This option is available for all paint tools except those which have a "rate" control, which automatically implies an incremental effect. See also Section 8.2.

14.3.1.3 Paint Mode Examples

The following examples demonstrate some of GIMP's paint modes:

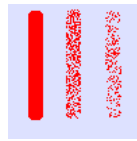
Dissolve

Figure 14.47 Dissolve mode example

Two brush-strokes made with the Airbrush, using the same fuzzy circular brush. Left: Normal mode. Right: Dissolve mode.

For any paint tool with opacity less than 100%, this very useful mode doesn't draw transparency but determines the probability of applying paint. This gives nice patterns of dots to paint-strokes or filling.

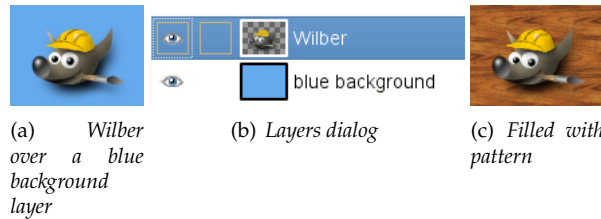
Figure 14.48 Painting in Dissolve mode



This image has only the background layer and no Alpha channel. The background color is sky blue. Three strokes with Pencil and various opacities: 100%, 50%, 25%. Foreground color pixels are scattered along brushstroke.

Behind

Figure 14.49 Example for layer mode “Behind”

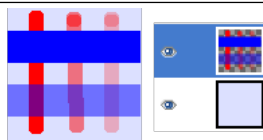


This mode applies paint only to transparent areas of the layer: the lower the opacity, the more paint is applied. Thus, painting opaque areas has no effect; painting transparent areas has the same effect as normal mode. The result is always an increase in opacity. Of course none of this is meaningful for layers that lack an alpha channel.

In the above example image, Wilber is on the top layer, surrounded by transparency. The lower layer is solid light blue. The Bucket Fill tool was used, with the Fill Whole Selection option checked and the entire layer was selected. A pattern was used to paint with the Bucket Fill tool.

The next image (below) has two layers. The upper layer is active. Three brush strokes with pencil, red color at 100%, 50%, 25%: only transparent or semi-transparent pixels of the layer are painted.

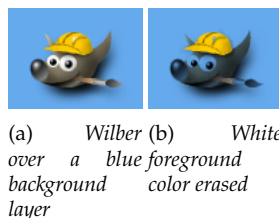
Figure 14.50 Painting in “Behind” mode



Painting with 100%, 50%, 25% transparency (from left to right)

Color Erase

Figure 14.51 Example for layer mode “Color erase”



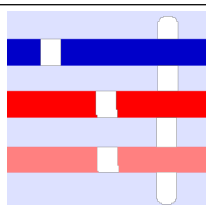
This mode erases the foreground color, replacing it with partial transparency. It acts like the **Color to Alpha** filter, applied to the area under the brushstroke. Note that this only works on layers that possess an alpha channel; otherwise, this mode is identical to Normal.

In the above example image, the color of the Bucket Fill tool was white, so white parts of Wilber were erased and the blue background shows through.

This image below has only one layer, the background layer. Background color is sky blue. Three brush strokes with pencil:

1. With the exact color of the blue area: only this blue color is erased.
2. With the exact color of the red area. Only this red color is erased, whatever its transparency. Erased areas are made transparent.
3. With the sky blue color of the layer background: only this color is erased.

Figure 14.52 Painting in “Color Erase” mode



Painted with 1. blue; 2. red; 3. background color

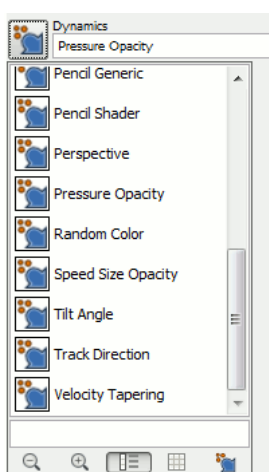
14.3.1.4 Further Information

Advanced users may be interested to know that paint tools actually operate at a sub-pixel level, in order to avoid producing jagged-looking results. One consequence of this is that even if you work with a hard-edged brush, such as one of the Circle brushes, pixels on the edge of the brushstroke will only be partially affected. If you need to have all-or-nothing effects (which may be necessary for getting a good selection, or for cutting and pasting, or for operating pixel-by-pixel at a high zoom level), use the Pencil tool, which makes all brushes perfectly hard and disables sub-pixel anti-aliasing.


14.3.2 Dynamics

The dynamics apply a more “real feeling” to the brush by connecting one or more of the brush parameters to the way of using the brush. You may for instance let the width of the pencil vary according to the speed of the stylus or the mouse, make the color saturation depending on the stylus pressure, make the color changing as the direction of the brush changes on the canvas, and so on. You may choose among several presets or define your own. The dynamics are created to be used together with drawing tablets, but some are available using the mouse.

The dynamics will make some of the behaviors of the drawing tools act more like the physical (“real”) tools.

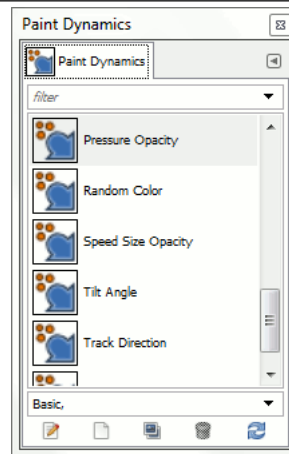


The Dynamics Preset List

The Dynamics area in the Tool Option dialog shows from left to right, the button to open the list containing the available dynamic presets, a field displaying the name of the current preset, and rightmost the edit button. Click on the  button to open the dialog window displaying the available dynamics presets and select another preset.

14.3.2.1 The Paint Dynamics Selection Dialog

Figure 14.53 The Paint Dynamics Selection Dialog



The Paint Dynamics dialog window can be opened

- from the image-menu: Windows → Dockable Dialogs → Paint Dynamics,
- or by clicking on the Open the dynamics selection button in the list of dynamics presets.

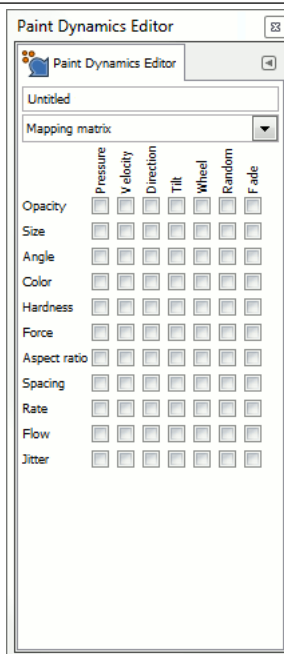
The Paint Dynamics dialog is a dockable dialog; please see the section Section 3.2.3 for help on manipulating it.

From this dialog you can select from all the available presets, just as from the list of dynamics presets. In addition there are five buttons:

- Edit dynamics: Click on this to edit the selected dynamics.
- Create a new dynamics: Do just that.
- Duplicate this dynamics: Make a copy of the selected dynamics.
- Delete this dynamics: Delete the selected dynamics.
- Refresh dynamics: Update the dynamics list.

14.3.2.2 Editing Paint Dynamics

Figure 14.54 Editing Paint Dynamics



The Paint Dynamics Editor can be called from:

- the edit button in the Tool Options dialog,
- the Paint Dynamics selection dialog by clicking either the Edit Dynamics button or the Create a New Dynamics button.

You select the desired behaviors by clicking in the small squares. Clicking a second time will unselect the marking.

Note



Pre-installed dynamics are grayed out meaning you are not allowed to change the settings. To edit the options you have to work on a copy made from one of the pre-installed dynamics or create a new dynamics.

14.3.2.3 The Paint Dynamics Matrix

The main part of the edit dialog is a table where you can decide which brush parameters should be affected by the way you use the stylus or the mouse. You can enable as many parameters and parameter combinations you want, but usually the fewer the better.

Each column in the table represents a stylus or mouse action except the random and the fade functions. All functions works with graphic tablet. Some of the functions are also available using the mouse. These functions are marked in the tables. The descriptions are using the default settings of all functions

- Pressure: It allows you to decide which aspects of the tool's action will be affected by pressing the stylus against the tablet.
- Velocity: (mouse) This is the speed of the brush.
- Direction: (mouse) This is the moving direction of the brush.

- Tilt: The behavior of the function depends on the tilting of the stylus.
- Wheel: The output depends on the rotation of the stylus or the setting of the wheel on the airbrush pen.
- Random: (mouse) The selected option will change at random.
- Fade: (mouse) The selected option will be faded in or out depending on the settings of the fade options in the Dynamic Options menu of the Tools Option dialog.

Each row shows a brush parameter and seven checkboxes, one for each action. You connect the parameters to the actions by clicking the appropriate boxes. Clicking on a selected box will unselect the connection.

Opacity Pressure: Press harder to make the drawing less transparent.

Velocity: (mouse) The opacity decreases as the speed of the stylus increases.

Direction: (mouse) The opacity depends on the direction of the stylus or the mouse. The effect seems to have a touch of randomness built in.

Tilt: The opacity depends on the tilt of the stylus.

Wheel: TO DO

Random: (mouse) The opacity changes at random in the interval set by the opacity slider in the Tool Options dialog.

Fade: (mouse) Starting with full transparency and ending with the opacity set by the opacity slider in the Tool Options dialog.

Size Pressure: Press harder to make the brush wider.

Velocity: (mouse) Increasing speed decreases the width of the brush.

Direction: (mouse) The size of the brush depends on the moving direction of the stylus or the mouse. The effect seems to have a touch of randomness built in.

Tilt: The size of the brush depends on the tilt of the stylus.

Wheel: TODO

Random: (mouse) The size of the brush changes at random up to the size set in the brush size slider in the Tool Options dialog.

Fade: (mouse) Fades from a narrow brush to the size set by the brush size slider in the Tools Options dialog.

Angle TO DO

Color By default the color is picked from the foreground color in the toolbox. However, if the color is activated in the dynamics editor, the color is instead collected from the active gradient.

Velocity: (mouse) At slow speeds the color is collected from the right side of the gradient. As the speed increase the color is picked more and more from the left side of the gradient.

Direction: (mouse) The direction determine where on the gradient the color is picked from. The effect seems to work a bit on random.

Random: (mouse) The color is picked at random from the gradient.

Fade: (mouse) The start color is collected from the left side of the gradient and then more and more from the right side during the stroke. The behavior of the fading is set in the Fade Options in the Tool Options Dialog.

Hardness The hardness option is useful only for fuzzy brushes.

Velocity: (mouse) At slow speed the brush is hard and become more fuzzy as the speed increase.

Random: (mouse) The fussiness of the brush varies at random.

Fade:(mouse) The brush become less fuzzy during the stroke. The behavior of the fading is set in the Fade Options in the Tool Options Dialog.

Force TO DO

Aspect Ratio The Aspect Ratio Slider in the Tool Options Dialog must be set to other values than the default value of 0.00 to activate the dynamics. If the aspect ratio slider is set to a negative value the width of the brush will vary while the height of the brush is constant. If the slider is set to a positive value only the height of the brush will vary.

Velocity: (mouse) The aspect ratio of the brush (width / height) varies with the speed of the brush.

Direction: (mouse) The aspect ratio of the brush varies with the moving direction of the brush. The effect seems to have a touch of randomness built in.

Random: (mouse) The aspect ratio of the brush varies at random.

Fade: (mouse) If the Aspect Ratio Slider is set to a positive value the brush will fade from full height at the start of the stroke to the height set by the aspect ratio slider. If the slider is set to a negative value the brush fades from full width to the width set by the aspect ratio slider. The behavior of the fading is set in the Fade Options in the Tool Options Dialog.

Spacing Spacing is the distance between the marks set by the brush when drawing lines. With this option set the spacing is affected by how the stylus or mouse is used.

Velocity: (mouse) The spacing between the footprints of the brush increases with increasing speed.

Direction: (mouse) The spacing varies with the moving direction of the brush. The effect seems to have a touch of randomness built in.

Random: (mouse) The spacing varies at random.

Fade: (mouse) Starting with a wide spacing and gradually make the spacing narrower. The behavior of the fading is set in the Fade Options in the Tool Options Dialog.

Rate This option applies to the Airbrush, Convolve tool, and Smudge tool, all of which have time-based effects.

The actions of these tools are more or less quick. The amount of Rate depends on the setting of the Rate slider in the Tool Options dialog.

Flow Significant only for the Airbrush: more or less paint is delivered. The amount of flow depends on the setting of the Flow slider in the Tool Options dialog.

Jitter Normally the brush draws a line by printing the brush marks close together. Adding jitter means that the brush prints are scattered along the line. The amount of scattering depends on the setting of the jitter slider in the Tool Options dialog window.

Pressure: At low pressure the brush prints are spread according to the value set in the jitter amount slider. As the pressure increases the scattering amount decreases.

Velocity: (mouse) At slow speed the brush prints are spread according to the value set in the jitter amount slider. As the speed increase the scattering amount decrease.

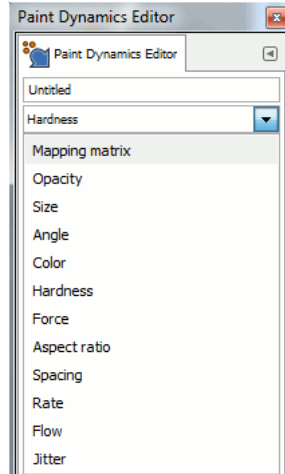
Direction: (mouse) The jitter effect depends on the direction of the brush. The effect seems to have a touch of randomness built in.

Random: (mouse)The jitter varies at random.

Fade: (mouse) Starting with no jitter and ending with the amount of jitter set in the jitter amount slider. The behavior of the fading is set in the fade options in the Tool Options dialog.

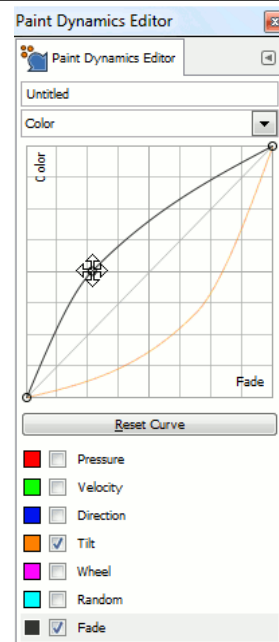
14.3.2.4 Customizing the Dynamics

Figure 14.55 Customizing the Dynamics



If the current options do not suits you, you may fine-tune the settings from the Paint Dynamics Editor. Click on the down arrow to open the drop down menu and then select what option to change.

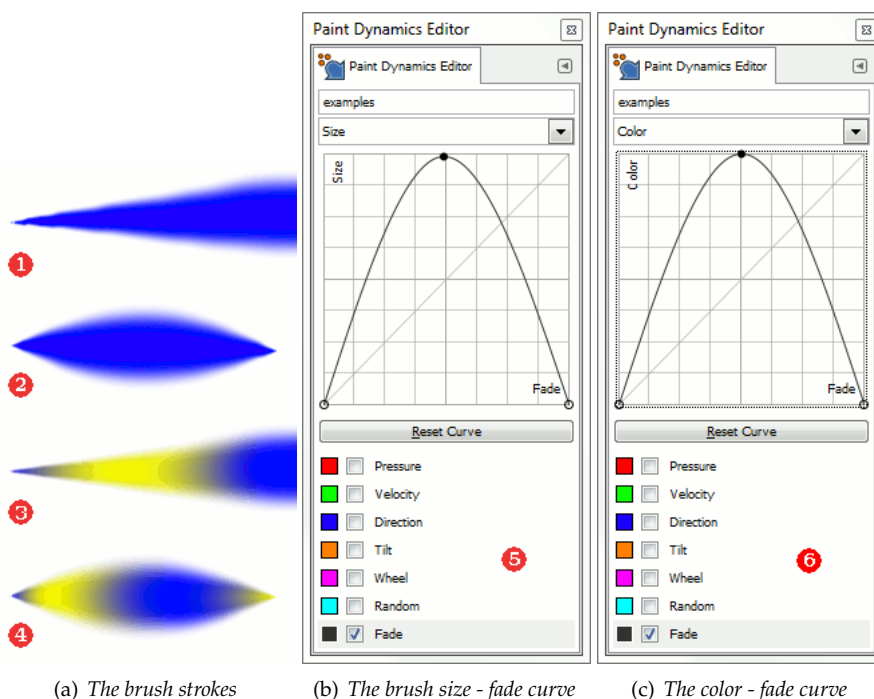
Figure 14.56 The Fine Tuning Curve



Click on one of the options to open the customizing dialog. The upper part of the dialog contains a curve where you can adjust the behaviour of the chosen parameters selected in the lower part of the dialog. You can drag the curve by pointing on it with the mouse pointer, holding down the left mouse button and the move the curve wherever you want inside the diagram.

14.3.2.5 Dynamics Examples

Figure 14.57 Dynamics Options



The examples shown are very brief, but will perhaps give you an idea of how to use this functions. Feel free to try other combinations. In these examples the foreground color is set to blue (#0000ff) and the background color to yellow (#ffff00). Fading: 200 pixels. Paintbrush size: 72. All other settings are the default values except for those values changed

- Example 1 shows the result when the brush size is connected to the fading. Default options. The brush size starts as zero and increase to the size set in the brush size slider in the Tools Options Dialog.
- In example 2 the brush size is still connected to the fade tool, but the fade curve is set as in image 5. The brush size starts at zero, fades up to full size and then fades down to zero again.

The full fade length is set along the x-axis from left to right. The y-axis determines the size of the brush. At the bottom the brush size is zero, and at the top of the diagram the brush is set to the full size according to the size set in the slider in the Brush Options Dialog. Study the example and the curve to see the relationship.

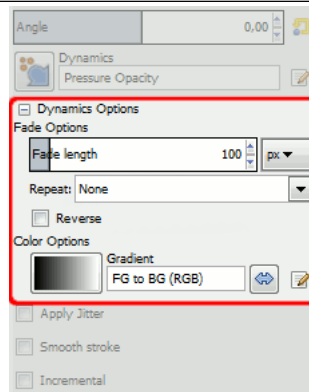
- In example 3 the brush size is disconnected from the fade tool. The color is connected with the fade option with the curve set as in image 6. At the start of the drawing the color is picked from the left side of the gradient, then gradually more from the right side of the gradient and then finally fading back to the left side again.

As usual the x-axis is the total fade length. When the curve is near the bottom of the diagram the color is picked from the left side of the gradient. With the curve at the top of the diagram the color is picked from the right side of the gradient.

- The last example shows a combination of these two settings. Both the size of the brush and the color are connected to the fading function with the curves set as in image 5 and 6.

14.3.2.6 Dynamics Options

Figure 14.58 Dynamics Options

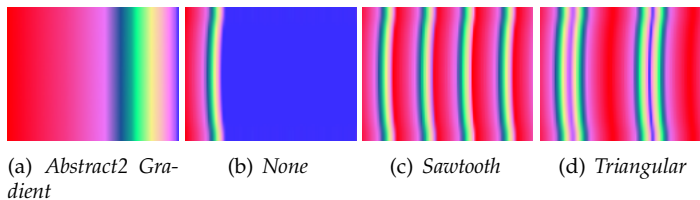


Many of the dynamics behaviors also depends on the settings of the Dynamics Options in the Tool Options dialog and vice versa. For example the fading will not work if it is not applied in the Dynamics section.

Fade Options This slider determines the length of the fading. What will actually happen depends on the setting of the Dynamic. If set to act on the color for example, the color will be taken from the current gradient starting from the left side of the gradient and moving toward the right side of the gradient.

The Fade Options has a drop down list determining how the fading is repeated.

Figure 14.59 Illustration of the effects of the three gradient-repeat options, for the Abstract 2 gradient.



(a) Abstract2 Gradient

(b) None

(c) Sawtooth

(d) Triangular

This option determines what happens if a brush stroke extends farther than the Length specified by the slider. There are three possibilities:

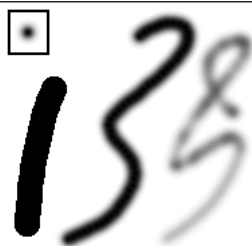
- None means that the color from the end of the gradient will be used throughout the remainder of the stroke;
- Sawtooth wave means that the gradient will be restarted from the beginning, which will often produce a color discontinuity;
- Triangular wave means that the gradient will be traversed in reverse, afterwards bouncing back and forth until the end of the brush stroke.

Color Options Here you can choose the gradient to use as color source when using the brush with the color option set. Click on the box showing the gradient to change to another one from the gradient list.

If no color option is selected in the currently used dynamics, the brush will use the foreground color set in the toolbox.

14.3.3 Brush Tools (Pencil, Paintbrush, Airbrush)

Figure 14.60 Painting example



Three strokes painted with the same round fuzzy brush (outline shown in upper left), using the Pencil (left), Paintbrush (middle), and Airbrush (right).

The tools in this group are GIMP's basic painting tools, and they have enough features in common to be worth discussing together in this section. Features common to all paint tools are described in the **Common Features** section. Features specific to an individual tool are described in the section devoted to that tool.

The Pencil is the crudest of the tools in this group: it makes hard, non-anti-aliased brushstrokes. The Paintbrush is intermediate: it is probably the most commonly used of the group. The Airbrush is the most flexible and controllable. This flexibility also makes it a bit more difficult to use than the Paintbrush, however.

All of these tools share the same brushes, and the same options for choosing colors, either from the basic palette or from a gradient. All are capable of painting in a wide variety of modes.

14.3.3.1 Key modifiers

Ctrl Holding down the **Ctrl** key changes each of these tools to a **Color Picker**: clicking on any pixel of any layer sets the foreground color (as displayed in the **Toolbox Color Area**) to the color of the pixel.

Shift This key places these tools into straight line mode. Holding **Shift** while clicking the mouse left Button will generate a straight line. Consecutive clicks will continue drawing straight lines that originate from the end of the last line.

14.3.4 Bucket Fill

Figure 14.61 Toolbox Fill



This tool fills a selection with the current foreground color. If you **Ctrl**+click and use the Bucket tool, it will use the background color instead. Depending on how the tool options are set, the Bucket Fill tool will either fill the entire selection, or only parts whose colors are similar to the point you click on. The tool options also affect the way transparency is handled.


The amount of fill depends on what Fill Threshold you have specified. The fill threshold determines how far the fill will spread (similar to the way in which the magic wand works). The fill starts at the point where you click and spreads outward until the color or alpha value becomes “too different”.

When you fill objects in a transparent layer (such as letters in a text layer) with a different color than before, you may find that a border of the old color still surrounds the objects. This is due to a low fill-threshold in the Bucket Fill options dialog. With a low threshold, the bucket tool won't fill semi-transparent pixels, and they will stand out against the fill because they have kept their original color.

If you want to fill areas that are totally transparent, you have to make sure that the “Lock” option (in the Layers dialog) is unchecked. If this option is checked, only the non-transparent parts of the layer will be filled.

14.3.4.1 Activating the tool

- You can find the Bucket Fill tool from the image-menu through: Tools → Paint Tools → Bucket Fill

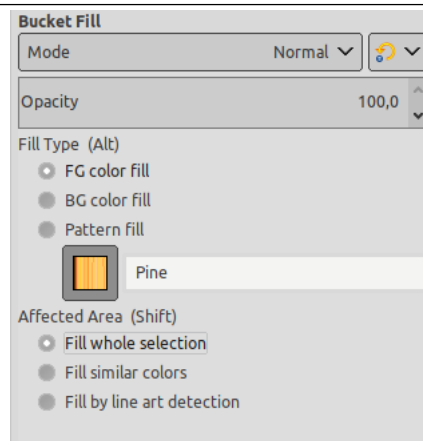
- You can also call it by clicking the tool icon:  in the toolbox.
- or by pressing the Shift-B keys.

14.3.4.2 Key modifiers

- **Ctrl**, similarly to paint tools, allows you to pick surrounding colors on canvas without having to switch to *Color Picker tool*.
- **Shift** toggles the use of Fill Similar Color or Fill Whole Selection on the fly.
- **Alt** toggles Fill type between FG and BG colors.

14.3.4.3 Options

Figure 14.62 “Bucket Fill” tool options



Normally, tool options are displayed in a window attached under the Toolbox as soon as you activate a tool. If they are not, you can access them from the image menu bar through Windows → Dockable Windows → Tool Options which opens the option window of the selected tool.

Mode; Opacity See [Paint Tools](#) for help with options that are common to all these tools. Only options that are specific to the Bucket Fill tool are explained here.

Fill Type GIMP provides three fill types:

FG Color Fill sets the fill color to the currently selected foreground color.

BG Color Fill sets the fill color to the currently selected background color.

Pattern Fill sets the fill color to the currently selected pattern. You can select the pattern to use in a drop down list.

This drop-down list allows the user to select one of many fill patterns to use on the next fill operation. The manner in which the list is presented is controlled by the four buttons at the bottom of the selector.

Affected Area

- Fill whole selection makes GIMP fill a pre-existent selection or the whole layer. A quicker approach to do the same thing could be to click and drag the foreground, background or pattern color, leaving it onto the selection. Also, pressing **Ctrl** key allows you to pick a color on the image as foreground color.
- Fill similar colors: this is the default setting: the tool fills the area with a color near the pixel onto you have clicked. The color similarity is defined by options in Finding Similar Colors. Click and drag to fill.
- Fill by line art detection: This is a new algorithm in GIMP-2.10.10 allowing you to fill areas surrounded by “line arts”, trying to leave no unfilled pixels near the lines, and closing potential zones.

Line art detection is also known as Smart Colorization. The author describes clearly problems he met in <https://girinstud.io/news/2019/02/smart-colorization-in-gimp/>. Options are described below.

Finding Similar Colors These options appear when the Fill similar colors option is checked:

- The option Fill Transparent Areas offers the possibility of filling areas with low opacity.
- The option Sample Merged toggles the sampling from all layers. If Sample Merged is active, fills can be made on a lower layer, while the color information used for threshold checking is located further up. Simply select the lower level and ensure that a layer above is visible for color weighting.
- To understand what diagonal neighbors are, please refer to [Diagonal-neighbors](#) in Fuzzy Select tool.
- Please refer to [Antialiasing](#) in Glossary.
- The Threshold slider sets the level at which color weights are measured for fill boundaries. A higher setting will fill more of a multi colored image and conversely, a lower setting will fill less area.
- With the Fill by option you can choose which component of the image GIMP shall use to calculate the similarity and to determine the borders of filling.

The components you can choose from are Composite, Red, Green, Blue, Alpha, HSV Hue, HSV Saturation, HSV Value, LCh Lightness, LCh Chroma, LCh Hue,

This option is not easy to understand. You have chosen, for example, the Red channel. When you click on any pixel, the tool searches for contiguous pixels similar for *the red channel* to the clicked pixel, according to the set threshold. Here is an example:

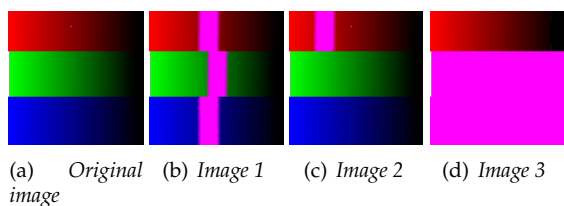
Original image: three strips with gradients of pure colors. Red (255;0;0), Green (0;255;0), Blue (0;0;255). We are going to use the Bucket-fill tool with the magenta color and a Threshold set to 15.

Image 1: Fill By = Composite. We successively clicked in the three color strips. Every strip is filled according to the threshold.

Image 2: Fill By = Red. We clicked in the red strip. The tool searches for contiguous pixels which have a similar value in the red channel, according to the set threshold. Only a narrow area corresponds to these standards. In the green and the blue strip, the value of pixels in the red channel is 0, very much different from the red channel value of the clicked pixel: the color doesn't spread to them.

Image 3: Fill By = Red. We clicked in the green strip. There, the value of the clicked pixel in the red channel is 0. All pixels in the green and the blue strips have the same red channel value (0): they are all painted.

Figure 14.63 Example for “Fill By”



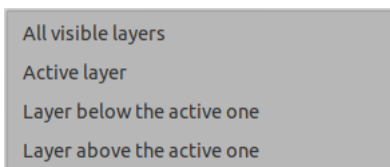
“Line Art Detection” options

Figure 14.64 “Fill by line art detection” example



(b) Bucket fill tool applied by click-and-drag with default options. They don't well fit this image, especially on eyebrows that are almost wiped off.

- Source: by default, information for line art computation is taken from all visible layers; you can choose another source:



- Fill transparent areas: fills completely transparent regions.
- Feather edges: feathers fill edges.



- Maximum growing size: maximum number of pixels grown under the line art. Increasing this value makes lines thinner.



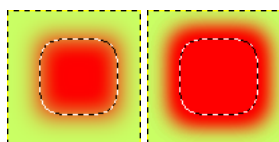
To improve eyebrows in the example, Maximum growing size is reduced to 1.

- Line art detection threshold: threshold to detect contour (higher values will detect more pixels).
- Maximum gap length : maximum gap (in pixels) in line art which can be closed.

14.3.4.4 Fill a feathered selection

By clicking repeatedly in a selection with feathered edges, you progressively fill the feathered border:

Figure 14.65 Example for “Fill a feathered Selection”



(a) Original image (b) After clicking 3 times more with the Bucket-Fill tool

14.3.5 Gradient

This tool fills the selected area with a gradient from the foreground and background colors by default, but there are many options. To make a gradient, drag the cursor in the direction you want the gradient to go and you release the mouse button when you feel you have the right position and size of your gradient. The softness of the gradient depends on how far you drag the cursor. The shorter the drag distance, the sharper it will be.

In former GIMP versions, you had to use the gradient editor to modify the gradient. With GIMP-2.10, this gradient editor still exists, but you can now edit it more easily directly on canvas.

If you click and drag outside the selection, only a part of the gradient will appear in the selection.

There are an astonishing number of things you can do with this tool, and the possibilities may seem a bit overwhelming at first. The two most important options you have are the Gradient and the Shape. Clicking the Gradient button in the tool options brings up a Gradient Select window, allowing you to

choose from among a variety of gradients supplied with GIMP; you can also construct and save custom gradients. Further information about gradients can be found in Section 7.10 and Section 15.3.4.

For Shape, there are 11 options: Linear, Bilinear, Radial, Square, Conical (symmetric), Conical (asymmetric), Shaped (angular), Shaped (spherical), Shaped (dimpled), Spiral (clockwise), and Spiral (counterclockwise); these are described in detail below. The Shaped options are the most interesting: they cause the gradient to follow the shape of the selection boundary, no matter how twisty it is. Unlike the other shapes, Shaped gradients are not affected by the length or direction of the line you draw: for them as well as every other type of gradient you are required to click inside the selection and move the mouse, but a Shaped appears the same no matter where you click or how you move.


Tip



Check out the Difference option in the Mode menu, where doing the same thing (even with full opacity) will result in fantastic swirling patterns, changing and adding every time you drag the cursor.

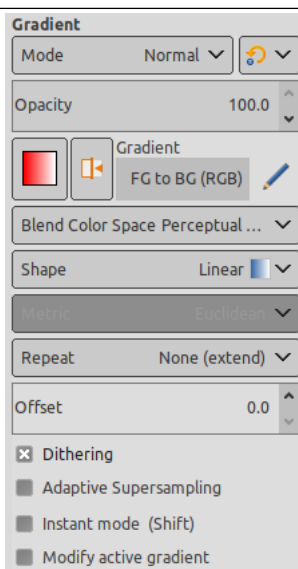
14.3.5.1 Activating the Tool

There are different possibilities to activate the tool:

- From the image-menu: Tools → Paint Tools → Blend.
- By clicking the tool icon .
- By clicking on the G keyboard shortcut.

14.3.5.2 Options

Figure 14.66 The Gradient tool dialog



Normally, tool options are displayed in a window attached under the Toolbox as soon as you activate a tool. If they are not, you can access them from the image menu bar through Windows → Dockable Windows → Tool Options which opens the option window of the selected tool.

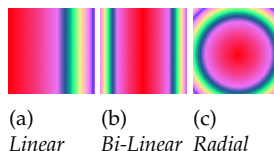
Mode; Opacity See the [Common Paint Tool Options](#) for a description of tool options that apply to many or all paint tools.

Gradient A variety of gradient patterns can be selected from the drop-down list. The tool causes a shading pattern that transitions from foreground to background color or introduces others colors, in the direction the user determines by drawing a line in the image. For the purposes of drawing the gradient, clicking on the Reverse reverses the gradient direction with the effect, for instance, of swapping the foreground and background colors.

On the right hand, a button to open the Gradient Editor dialog.

Shape The GIMP provides 11 shapes, which can be selected from the drop-down list. Details on each of the shapes are given below.

Figure 14.67 Examples of gradient shapes



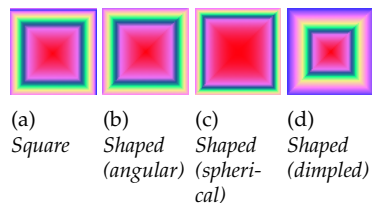
Linear This gradient begins with the foreground color at the starting point of the drawn line and transitions linearly to the background color at the ending point.

Bi-Linear This shape proceeds in both directions from the starting point, for a distance determined by the length of the drawn line. It is useful, for example, for giving the appearance of a cylinder.

Radial This gradient gives a circle, with foreground color at the center and background color outside the circle. It gives the appearance of a sphere without directional lighting.

Square; Shaped

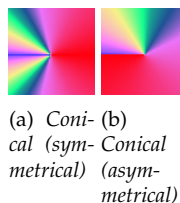
Figure 14.68 Square-shaped gradient examples



There are four shapes that are some variant on a square: Square, Shaped (angular), Shaped (spherical), and Shaped (dimpled). They all put the foreground color at the center of a square, whose center is at the start of the drawn line, and whose half-diagonal is the length of the drawn line. The four options provide a variety in the manner in which the gradient is calculated; experimentation is the best means of seeing the differences.

Conical (symmetric); Conical (asymmetric)

Figure 14.69 Conical gradient examples

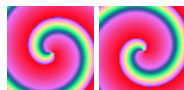


The Conical (symmetrical) shape gives the sensation of looking down at the tip of a cone, which appears to be illuminated with the background color from a direction determined by the direction of the drawn line.

Conical (asymmetric) is similar to Conical (symmetric) except that the "cone" appears to have a ridge where the line is drawn.

Spiral (clockwise); Spiral (counterclockwise)

Figure 14.70 Spiral gradient examples

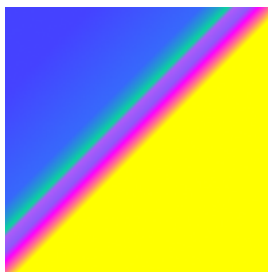


(a) *Spiral (clockwise)* (b) *Spiral (counterclockwise)*

The Spiral shape provide spirals whose repeat width is determined by the length of the drawn line.

Repeat

- None as default.



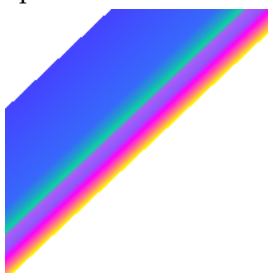
- Sawtooth Wave: the Sawtooth pattern is achieved by beginning with the foreground, transitioning to the background, then starting over with the foreground.



- Triangular Wave: starts with the foreground, transitions to the background, then transitions back to the foreground.



- Truncate: areas before and after endpoints are truncated.

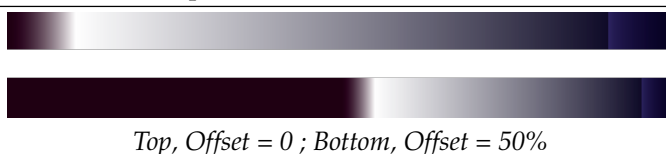


Dithering Dithering is fully explained in the [Glossary](#)

Adaptive Supersampling This a more sophisticated means of smoothing the “jagged” effect of a sharp transition of color along a slanted or curved line. Only tests can allow you to choose.

Offset The Offset value permits to increase the “slope” of the gradient. It determines how far from the clicked starting point the gradient will begin. Shaped forms are not affected by this option.

Figure 14.71 “Blend” tool: Offset example



Instant mode

Warning



The option must be activated (with **Shift** also) before starting drawing gradient.

When this option is checked, gradient tool works as in GIMP-2.8 : the gradient line disappears as soon as you release the mouse button. You can't edit color stops before applying the gradient fill.

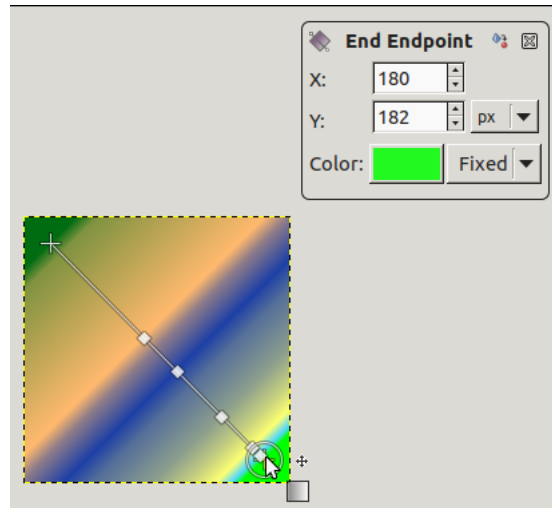
Modify active gradient When this option is checked, gradient tool works as in GIMP-2.8 : the custom gradient is not created automatically and must be created manually. The option can be activated before starting drawing gradient or if the active gradient is not the custom gradient. Allows changing user-writable gradients directly rather than creating copies of them.

14.3.5.3 Editing Gradient

Important change with GIMP-2.10 in editing gradient:

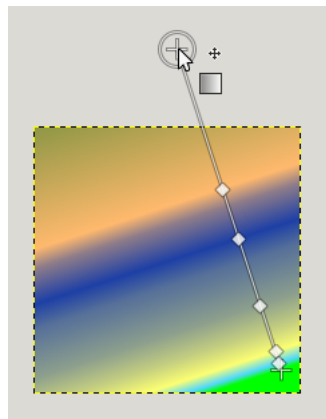
On-canvas editing All the old Gradient Editor dialog features are now available directly on canvas. You can create and delete color stops, select and shift them, assign colors to color stops, change blending and coloring for segments between color stops, create color stops from midpoints.

Select a gradient in the gradient dialog. Click and drag on canvas. A line is drawn and the gradient is displayed. You can edit this gradient by moving the mouse pointer on this line. As soon as you try to edit gradient, GIMP-2.10 creates a custom gradient, which is a copy of the selected gradient. It becomes the active gradient and will be preserved across sessions. Here, we use the Abstract3 gradient.



The Abstract3 gradient, with endpoints

At both ends of the line, you can see a Start endpoint and an End endpoint. Click and drag an endpoint (the mouse pointer is accompanied with a moving cross) to move it where you want on your screen. A small window appears showing data about the selected endpoint : the position of the mouse (coordinate origin is the upper left corner of image or selection), the starting (left) and the ending (right) color of the gradient.



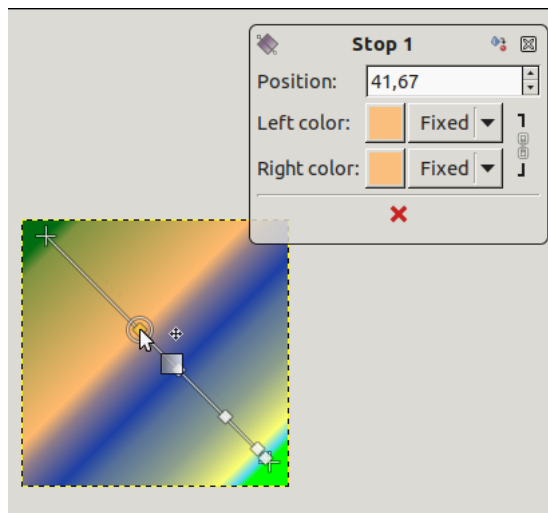
End point moved

Note





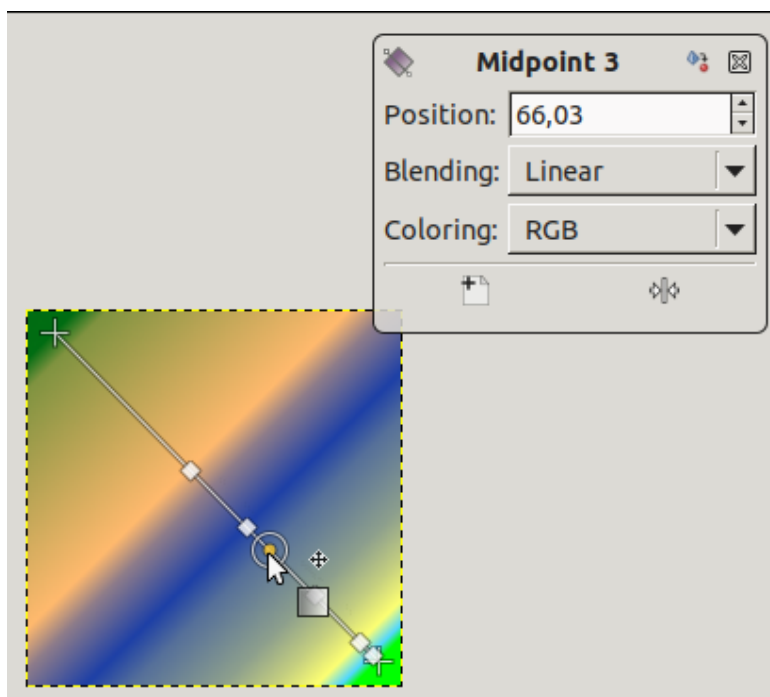
In you only move endpoints, the custom gradient is not created yet.

On the line, you can see several small squares. These are Stops that divide gradient into segments. You can edit segments separately. Click and drag stops to move them (the active endpoint takes a yellow color). As soon as you move a stop, the custom gradient is created. The small data window shows a button that allow you to remove the active stop.



Stop point moved and data window

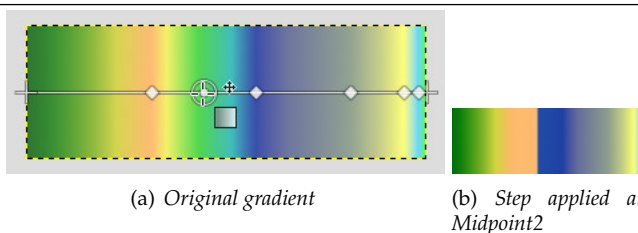
If you move the mouse pointer on the line, a Midpoint shows up. Then, the small data window has two buttons :  to create a new stop at midpoint, and  to center midpoint.



For Stops and Midpoints, Position refers to the gradient line: 0 is start endpoint, 100 is end endpoint.

Blending: you can change the blending mode between two stops, using the drop-down list. Step option appeared with GIMP-2.10.8: it creates a hard-edge transition between the two adjacent color stops at the midpoint.

Figure 14.72 "Step" option example



(a) Original gradient

(b) Step applied at Midpoint2

Changing color: in stop and end data windows, you have color dwells with a drop-down list. The default option is Fixed; this means that color choice will be independent from foreground and background colors. Click on a color dwell to open a color selector.

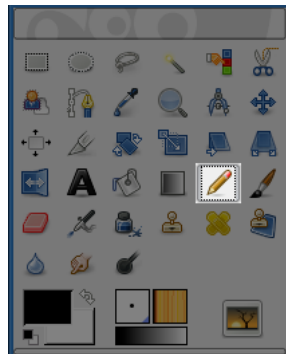
Key modifiers (Defaults) **Ctrl** is used to create straight lines that are constrained to 15 degree absolute angles.

Alt or **Ctrl-Alt** to move the whole line.

The Gradient Editor The Gradient Editor still exists: Section [15.3.4.3](#).

14.3.6 Pencil

Figure 14.73 Pencil tool



The Pencil tool is used to draw free hand lines with a hard edge. The pencil and paintbrush are similar tools. The main difference between the two tools is that although both use the same type of brush, the pencil tool will not produce fuzzy edges, even with a very fuzzy brush. It does not even do anti-aliasing.


Why would you want to work with such a crude tool? Perhaps the most important usage is when working with very small images, such as icons, where you operate at a high zoom level and need to get every pixel exactly right. With the pencil tool, you can be confident that every pixel within the brush outline will be changed in exactly the way you expect.

Tip



If you want to draw straight lines with the Pencil (or any of several other paint tools), click at the starting point, then hold down **Shift** and click at the ending point.

14.3.6.1 Activating the Tool

- The Pencil Tool can be called from the image-menu: Tools → Paint Tools → Pencil
- The Tool can also be called by clicking the tool icon: 
- or by clicking on the N keyboard shortcut.

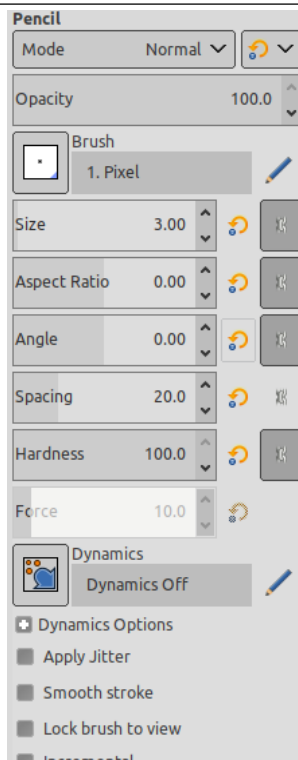
14.3.6.2 Key modifiers (Defaults)

Ctrl This key changes the pencil to a **Color Picker**.

Shift This key places the pencil tool into straight line mode. Holding **Shift** while clicking the mouse Left Button will generate a straight line. Consecutive clicks will continue drawing straight lines that originate from the end of the last line.

14.3.6.3 Options

Figure 14.74 “Pencil” Tool options

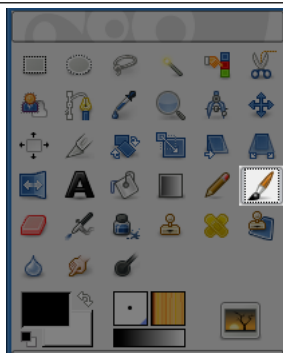


Normally, tool options are displayed in a window attached under the Toolbox as soon as you activate a tool. If they are not, you can access them from the image menu bar through Windows → Dockable Windows → Tool Options which opens the option window of the selected tool.

Mode; Opacity; Brush; Size; Aspect Ratio; Angle; Spacing; Hardness; Dynamics; Dynamics Options; Force; Apply
See the [Common Paint Tool Options](#) for a description of tool options that apply to many or all paint tools.

14.3.7 Paintbrush


Figure 14.75 Paintbrush



The paintbrush tool paints fuzzy brush strokes. All strokes are rendered using the current brush.

14.3.7.1 Activating the Tool

- You can call the Paintbrush Tool in the following order, from the image-menu: Tools → Paint Tools → Paintbrush.

- The Tool can also be called by clicking the tool icon: 
- or by using the **P** keyboard shortcut.

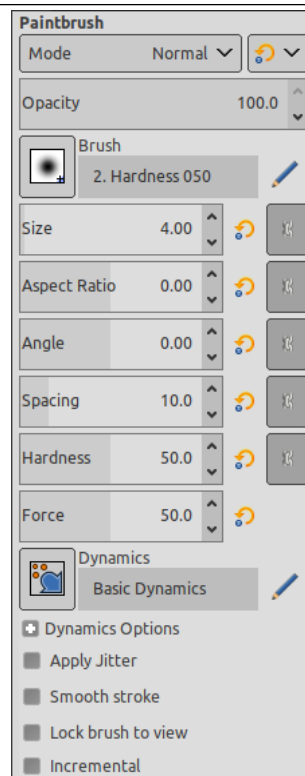
14.3.7.2 Key modifiers (Defaults)

Ctrl This key changes the paintbrush to a **Color Picker**.

Shift This key places the paintbrush into straight line mode. Holding **Shift** while clicking Button 1 will generate a straight line. Consecutive clicks will continue drawing straight lines that originate from the end of the last line.

14.3.7.3 Options

Figure 14.76 Paintbrush tool options

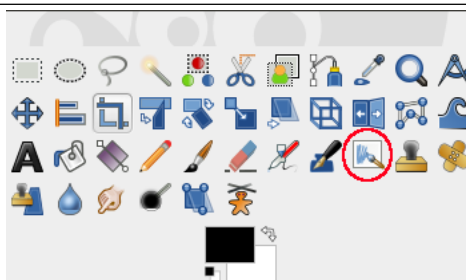


Normally, tool options are displayed in a window attached under the Toolbox as soon as you activate a tool. If they are not, you can access them from the image menu bar through **Windows → Dockable Windows → Tool Options** which opens the option window of the selected tool.

Mode; Opacity; Brush; Size; Aspect Ratio; Angle; Spacing; Hardness; Dynamics; Dynamics Options; Force; Apply Jitter
See the **Common Paint Tool Options** for a description of tool options that apply to many or all paint tools.

14.3.8 MyPaint Brush

Figure 14.77 MyPaint Brush Tool



MyPaint is a free painting program that comes with a lot of specific brushes. Libmypaint has been modified in 2016 in a form that can be used by other programs. GIMP-2.10 can use these brushes.

You can find many collections of MyPaint brushes throughout the Web, in a compressed format, often in a .zip file. Unzip this file into a temp folder.

14.3.8.1 Installing MyPaint Brushes

First go to Preferences → Folders → MyPaint Brushes. There, you will find the path to your personal Mypaint folder.

- *Under Linux:* /home/YourUserName/.mypaint/brushes. Take good note it is a hidden directory.

Open your file browser. Check the option “Show hidden files”. Go to your personal MyPaint folder. If it does not exist yet, you have to create it, with the brushes directory inside.

Copy-paste all the unzipped files from your temp folder to home/YourUserName/.mypaint/brushes.

- *Under Windows 10 (and GIMP 2.10):* ~\.mypaint\brushes. Click on this item to select it and click on the icon that opens a file browser. In the root of your home folder, create a new folder “mypaint”. The MyPaint path in Preferences becomes C:\Users\your-user-name\mypaint.

Copy-paste all the unzipped files from your temp folder to C:\Users\your-user-name\mypaint.

Activate the tool as below: you should have got a MyPaint brush icon in the tool options dialog. Click on this icon to display all MyPaint brushes.

14.3.8.2 Activating the Tool

There are different possibilities to activate the tool:

- From the image-menu: Tools → Paint Tools → MyPaint Brush,

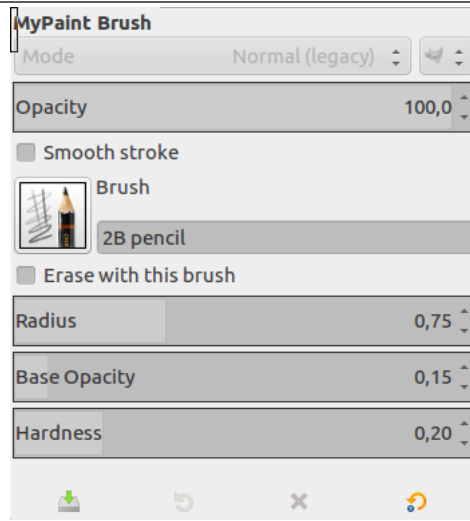
- The Tool can also be called by clicking the tool icon:



- or by clicking on the Y keyboard shortcut.

14.3.8.3 Options

Figure 14.78 MyPaint Brush Tool Options



The available tool options can be accessed by double clicking the Mypaint brush tool icon.

Options may act somewhat differently according to the MyPaint brush you use.

Opacity To set the opacity of the brush (0.0 - 100.0). Opacity depends on a base: please see below.

Smooth stroke If this option is checked, strokes are smoother. Two options are available:

- Quality: TODO
- Weight: TODO

Brush The icon of the active brush is displayed. If you click on it, the MyPaint brushes list is displayed and you can select another brush

Figure 14.79 A collection of MyPaint brushes












In the bottom bar of the dialog, you have buttons for smaller or larger icons, and view as list or as grid.

Erase with this brush If this option is checked, the brush acts as an eraser. As for the Eraser tool, erased areas are transparent if there is an alpha layer, have the background color if there is no alpha layer.

Radius To set the radius of the brush.

Base opacity These values (0.00 - 2.00) are multiplying factors: if, for example, you set this option to 0.50, the maximal opacity becomes $100 * 0.50 = 50$, although it is still 100.0 in the Opacity option.

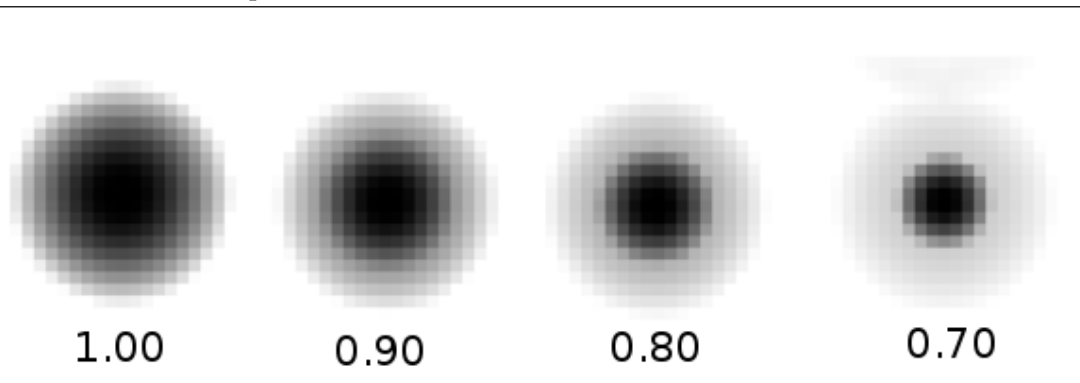
Figure 14.80 Base opacity example

Base opacity	Opacity		
	100	50	25
1.00	 = 100	 = 50	 = 25
0.50	 = 50	 = 25	 = 12.5
2.00	 = 100	 = 100	 = 50

Base opacity can exceed 1.00 up to 2.00. Of course, opacity can not exceed 100. In the example, you can see that an opacity option above 50 ($100 * 2.00 = 200$) is actually an opacity at 100, and $25 * 200 = 50$ is equivalent to $50 * 1.00 = 50$. But this possibility is useful when your MyPaint brush has a default opacity less than 100.

Hardness The harder the brush the sharper the brush. When you reduce hardness, the MyPaint brush may not act if the the brush size is too small.

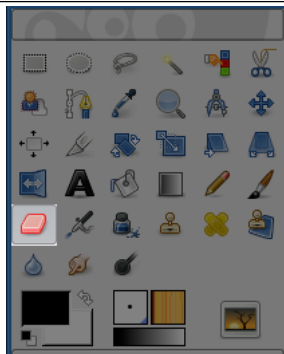
Figure 14.81 Hardness example



This MyPaint brush doesn't act when hardness is less than 0.70.

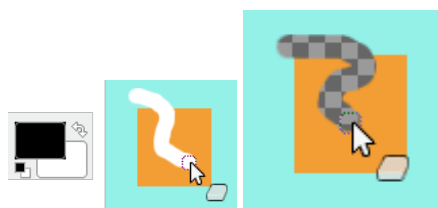
14.3.9 Eraser

Figure 14.82 Eraser tool icon in the Toolbox



The Eraser is used to remove areas of color from the current layer or from a selection of this layer. If the Eraser is used on something that does not support transparency (a selection mask channel, a layer mask, or the Background layer if it lacks an alpha channel), then erasing will show the background color, as displayed in the Color Area of the Toolbox (in case of a mask, the selection will be modified). Otherwise, erasing will produce either partial or full transparency, depending on the settings for the tool options. You can learn more on how to add an alpha channel to a layer in Section 16.7.33.

Figure 14.83 Eraser and Alpha channel



(a) The Background Color (b) The image has is White. The image has no an Alpha channel. The Eraser shows (Opacity 100%) shows the transparency. BG color.

If you need to erase some group of pixels completely, leaving no trace behind of their previous contents, you should check the “Hard edge” box in the Tool Options. Otherwise, sub-pixel brush placement will cause partial erasure at the edges of the brush-stroke, even if you use a hard-edged brush.

Tip




If you use GIMP with a tablet, you may find it convenient to treat the reverse end of the stylus as an eraser. To make this work, all you need to do is click the reverse end on the Eraser tool in the Toolbox. Because each end of the stylus is treated as a separate input device, and each input device has its own separate tool assignment, the reverse end will then continue to function as an Eraser as long as you don't select a different tool with it.

14.3.9.1 Activating the tool

You can activate this tool in several ways:

- From the image menu through Tools → Paint Tools → Eraser;

- from the Toolbox by clicking on the tool icon  ;
- or from the keyboard using the shortcut Shift-E.

14.3.9.2 Key modifiers

See the Section 14.3.1 for a description of key modifiers that have the same effect on all paint tools.

Ctrl For the Eraser, holding down the **Ctrl** key puts it into “color picker” mode, so that it selects the color of any pixel it is clicked on. Unlike other brush tools, however, the Eraser sets the *background* color rather than the foreground color. This is more useful, because on drawables that don’t support transparency, erasing replaces the erased areas with the current background color.

Alt For the Eraser, holding down the **Alt** key switches it into “anti-erase” mode, as described below in the Tool Options section. Note that on some systems, the **Alt** key is trapped by the Window Manager. If this happens to you, you may be able to use Alt-Shift instead.

14.3.9.3 Tool Options

Figure 14.84 Tool Options for the Eraser tool



Normally, tool options are displayed in a window attached under the Toolbox as soon as you activate a tool. If they are not, you can access them from the image menu bar through Windows → Dockable Windows → Tool Options which opens the option window of the selected tool.

Opacity; Brush; Size; Aspect Ratio; Angle; Spacing; Hardness; Dynamics; Dynamics Options; Force; Apply Jitter;

See the **Common Paint Tool Options** for a description of tool options that apply to many or all paint tools.

Opacity The Opacity slider, in spite of its name, in this tool determines the “strength” of the tool. Thus, when you erase on a layer with an alpha channel, the higher the opacity you use, the more transparency you get!

Hard Edge This option avoids partial erasure at the edges of the brush-stroke. See above.

Anti Erase The Anti Erase option of the Erase tool can un-erase areas of an image, even if they are completely transparent. This feature only works when used on layers with an alpha channel. In addition to the check-button in the Tool Options, it can also be activated on-the-fly by holding down the **Alt** key (or, if the **Alt** key is trapped by the Window Manager, by holding down Alt-Shift).

Note



To understand how anti-erasing is possible, you should realize that erasing (or cutting, for that matter) only affects the alpha channel, not the RGB channels that contain the image data. Even if the result is completely transparent, the RGB data is still there, you simply can't see it. Anti-erasing increases the alpha value so that you can see the RGB data once again.

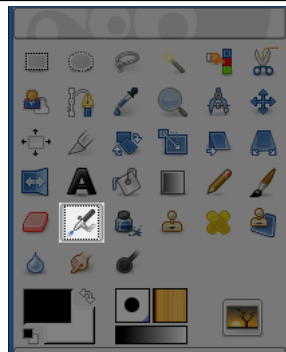
Tip



You can use the Eraser tool to change the shape of a floating selection. By erasing, you can trim the edges of the selection.

14.3.10 Airbrush


Figure 14.85 The Airbrush tool in Toolbox



The Airbrush tool emulates a traditional airbrush. This tool is suitable for painting soft areas of color.

14.3.10.1 Activating the Tool

You can activate the Airbrush tool in several ways :

- From the image-menu, through : Tools → PaintTools → Airbrush
- By clicking on the tool icon:  in the Toolbox,
- By using the **A** keyboard shortcut.

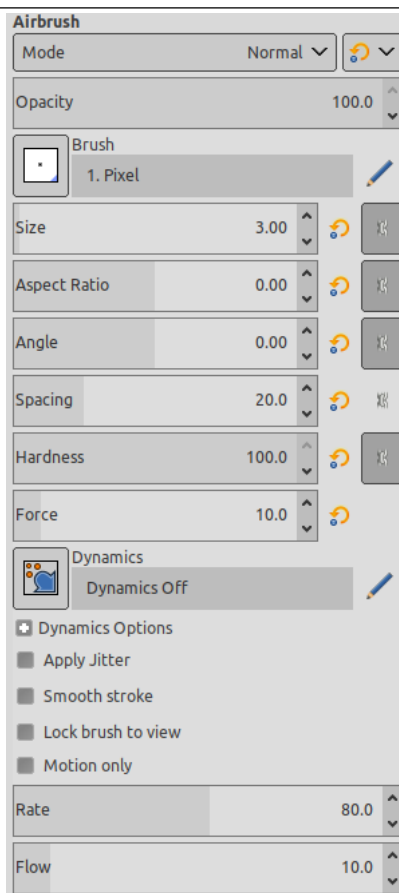
14.3.10.2 Key modifiers (Defaults)

Ctrl **Ctrl** changes the airbrush to a **Color Picker**.

Shift **Shift** places the airbrush into straight line mode. Holding **Shift** while clicking the mouse Left Button will generate a straight line. Consecutive clicks will continue drawing straight lines that originate from the end of the last line.

14.3.10.3 Options

Figure 14.86 Airbrush options



Normally, tool options are displayed in a window attached under the Toolbox as soon as you activate a tool. If they are not, you can access them from the image menu bar through Windows → Dockable Windows → Tool Options which opens the option window of the selected tool.

Mode; Opacity; Brush; Size; Aspect Ratio; Angle; Spacing; Hardness; Dynamics; Dynamics Options; Force; Appl
See the **Common Paint Tool Options** for a description of tool options that apply to many or all paint tools.

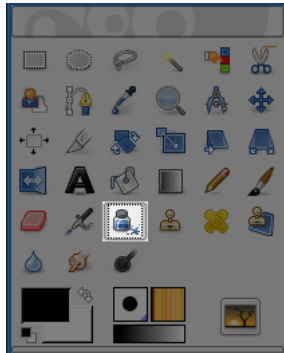
Motion only: if this option is checked, the airbrush paints only when it moves.

Rate The Rate slider adjusts the speed of color application that the airbrush paints. A higher setting will produce darker brush strokes in a shorter amount of time.

Flow This slider controls the amount of color that the airbrush paints. A higher setting here will result in darker strokes.

14.3.11 Ink


Figure 14.87 The “Ink” tool in Toolbox



The Ink tool uses a simulation of an ink pen with a controllable nib to paint solid brush strokes with an antialiased edge. The size, shape and angle of the nib can be set to determine how the strokes will be rendered.

14.3.11.1 Activating the Tool

You can find the Ink tool in several ways :

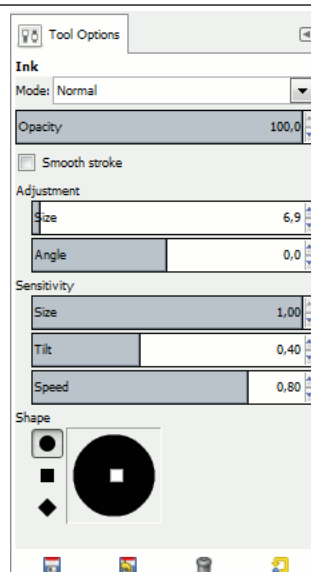
- In the image-menu through: Tools → Paint Tools → Ink.
- By clicking on the tool icon:  in Toolbox,
- or by using the **K** keyboard shortcut.

14.3.11.2 Key modifiers (Defaults)

Ctrl This key changes the nib to a **Color Picker**.

14.3.11.3 Options

Figure 14.88 Ink Tool options



Normally, tool options are displayed in a window attached under the Toolbox as soon as you activate a tool. If they are not, you can access them from the image menu bar through Windows → Dockable Windows → Tool Options which opens the option window of the selected tool.

Mode; Opacity See the [Common Paint Tool Options](#) for a description of tool options that apply to many or all paint tools.

Adjustment

Size Controls the apparent width of the pen's nib with values that ranges from 0 (very thin) to 20 (very thick).

Angle This controls the apparent angle of the pen's nib relative to horizontal.

Sensitivity

Size This controls the size of the nib, from minimum to maximum. Note that a size of 0 does not result in a nib of size zero, but rather a nib of minimum size.

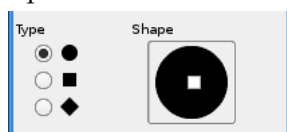
Tilt Controls the apparent tilt of the nib relative to horizontal. This control and the Angle control described above are interrelated. Experimentation is the best means of learning how to use them.

Speed This controls the effective size of the nib as a function of drawing speed. That is, as with a physical pen, the faster you draw, the narrower the line.

Type and Shape

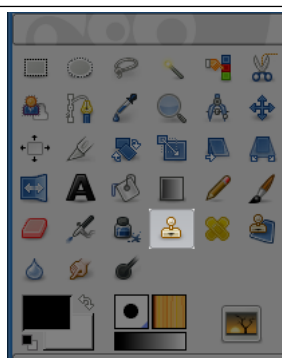
Type There are three nib shapes to choose from: circle, square, and diamond.

Shape The geometry of the nib type can be adjusted by holding button 1 of the mouse on the small square at the center of the Shape icon and moving it around.




14.3.12 Clone

Figure 14.89 Clone tool icon in the Toolbox



The Clone tool uses the current brush to copy from an image or pattern. It has many uses: one of the most important is to repair problem areas in digital photos, by “painting over” them with pixel data from other areas. This technique takes a while to learn, but in the hands of a skilled user it is very powerful. Another important use is to draw patterned lines or curves: see [Patterns](#) for examples.

If you want to clone from an image, instead of a pattern, you must tell GIMP which image you want to copy from. You do this by holding down the **Ctrl** key and clicking in the desired source image. Until you have set the source in this way, you will not be able to paint with the Clone tool: the tool cursor tells you this by showing .

If you clone from a pattern, the pattern is *tiled*; that is, when the point you are copying from moves past one of the edges, it jumps to the opposite edge and continues, as though the pattern were repeated


side-by-side, indefinitely. When you clone from an image this does not happen: if you go beyond the edges of the source, the Clone tool stops producing any changes.

You can clone from any drawable (that is, any layer, layer mask, or channel) to any other drawable. You can even clone to or from the selection mask, by switching to QuickMask mode. If this means copying colors that the target does not support (for example, cloning from an RGB layer to an Indexed layer or a layer mask), then the colors will be converted to the closest possible approximations.

14.3.12.1 Activating the tool

You can activate this tool in several ways:


- From the image menu through Tools → Paint Tools → Clone.

- By clicking on the tool icon  in Toolbox.

- By pressing the C keyboard shortcut.

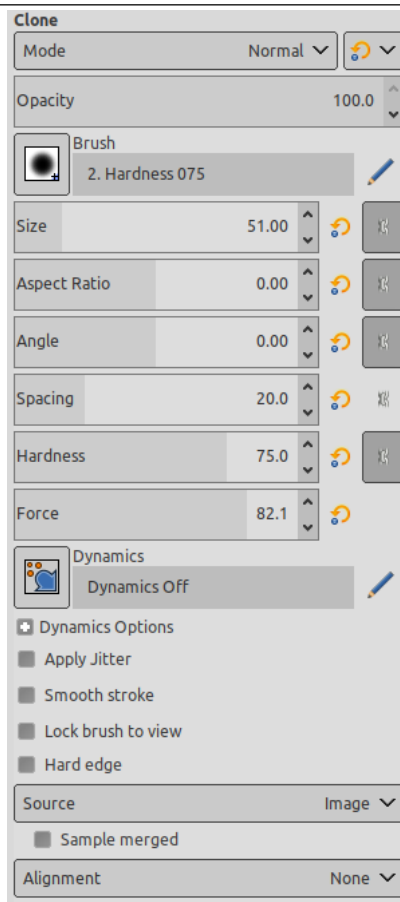
14.3.12.2 Key modifiers (default)

See the [Paint tools key modifiers](#) for a description of key modifiers that have the same effect on all paint tools.

Ctrl The **Ctrl** key is used to select the source, if you are cloning from an image: it has no effect if you are cloning from a pattern. You can clone from any layer of any image, by clicking on the image display, with the **Ctrl** key held down, while the layer is active (as shown in the Layers dialog). If Alignment is set to None, Aligned, or **Fixed** in tool options, then the point you click on becomes the origin for cloning: the image data at that point will be used when you first begin painting with the Clone tool. In source-selection mode, the cursor changes to a reticle cross symbol .

14.3.12.3 Options

Figure 14.90 Tool Options for the Clone tool



Normally, tool options are displayed in a window attached under the Toolbox as soon as you activate a tool. If they are not, you can access them from the image menu bar through Windows → Dockable Windows → Tool Options which opens the option window of the selected tool.

Mode; Opacity; Brush; Size; Aspect Ratio; Angle; Spacing; Hardness; Dynamics; Dynamics Options; Force; Appl

See the [Common Paint Tool Options](#) for a description of tool options that apply to many or all paint tools.

Hard edge: this option gives a hard contour to the cloned area.

Source The choice you make here determines whether data will be copied from the pattern shown above, or from one of the images you have open.

Image If you choose Image source, you must tell GIMP which layer to use as the source, by **Ctrl**-clicking on it, before you can paint with the tool.

If you check **Sample merged** it's what you "see" (color made with all the layers of a multi-layer image) that's cloned. If it's unchecked, only the selected layer is cloned. For more information about non-destructive image editing with **Sample merged** see [Sample Merge](#).

Pattern Clicking on the pattern symbol brings up the Patterns dialog, which you can use to select the pattern to paint with. This option is only relevant if you are cloning from a Pattern source.

Sample merged If this option is not checked (default), Clone tool samples from the active layer.

If this option is checked, Clone tool samples from all layers. This allows you to work in a non-destructive fashion, without modifying original pixels: you create a new layer (transparent) above the image layer; this new layer being active, all cloned pixels will appear in this layer.

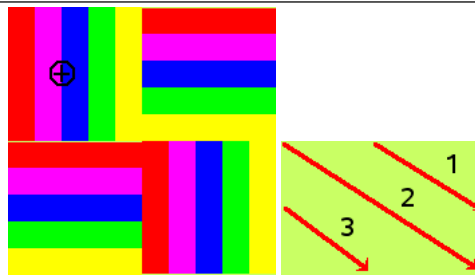


Cloned pixels are in the new layer.

Alignment The Alignment mode defines the relation between the brush position and the source position.

In the following examples, we will use a source image where the sample to be cloned will be taken, and a destination image where the sample will be cloned (it could be a layer in the source image)

Figure 14.91 Original images for clone alignment

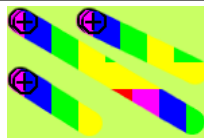


(a) We will use the largest source is represented here with a ringed cross.
 (b) An image with a brush with the Pencil tool. The solid background only. We shall draw three cloning strokes successively.

None In this mode, each brushstroke is treated separately. For each stroke, the point where you first click is copied from the source origin; there is no relationship between one brush stroke and another. In non-aligned mode, different brush strokes will usually clash if they intersect each other.

Example below: At every new brush stroke, the source goes back to its first position. The same sample is always cloned.

Figure 14.92 "None" clone alignment

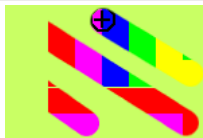


Aligned In this mode, the first click you make when painting sets the offset between the source origin and the cloned result, and all subsequent brushstrokes use the same offset. Thus, you can use as many brushstrokes as you like, and they will all mesh smoothly with one another. If you want to change the offset, select a new source origin by clicking with the **Ctrl** key pressed.

In the example below, at every new brush stroke, the source keeps the same offset it had with the previous brush stroke. So, there is no cloning offset for the first brush stroke. Here, for

the following strokes, the source ends up out of the source image canvas; hence the truncated aspect.

Figure 14.93 “Aligned” clone alignment



Registered The “Registered” mode is different from the other alignment modes. When you copy from an image, a **Ctrl**-click will register a source layer. Then painting in a target layer will clone each corresponding pixel (pixel with the same offset) from the source layer. This is useful when you want to clone parts of an image from one layer to another layer within the same image. (But remember that you can also clone from one image to another image.)

At every brush stroke, the source adopts the position of the mouse pointer in the destination layer. In the following example, the destination layer is smaller than the source layer; so, there is no truncated aspect.

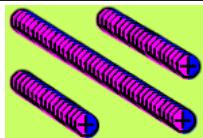
Figure 14.94 “Registered” clone alignment



Fixed Using this mode you will paint with the source origin, unlike the modes None or Aligned even when drawing a line. The source will not be moved.

See that the source remains fixed. The same small sample is reproduced identically in a tightened way:

Figure 14.95 “Fixed” clone alignment



14.3.12.4 Further Information

Transparency The effects of the Clone tool on transparency are a bit complicated. You cannot clone transparency: if you try to clone from a transparent source, nothing happens to the target. If you clone from a partially transparent source, the effect is weighted by the opacity of the source. So, assuming 100% opacity and a hard brush:

- Cloning translucent black onto white produces gray.
- Cloning translucent black onto black produces black.
- Cloning translucent white onto white produces white.
- Cloning translucent white onto black produces gray.

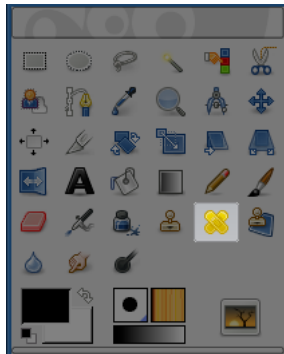
Cloning can never increase transparency, but, unless “keep transparency” is turned on for the layer, it can reduce it. Cloning an opaque area onto a translucent area produces an opaque result; cloning a translucent area onto another translucent area causes an increase in opacity.

“Filter” brushes There are a few non-obvious ways to use the Clone tool to obtain powerful effects. One thing you can do is to create “Filter brushes”, that is, create the effect of applying a filter with a brush. To do this, duplicate the layer you want to work on, and apply the filter to the copy. Then activate the Clone tool, setting Source to “Image source” and Alignment to “Registered”. **Ctrl**-click on the filtered layer to set it as the source, and paint on the original layer: you will then in effect be painting the filtered image data onto the original layer.

History brush You can use a similar approach to imitate Photoshop’s “History brush”, which allows you to selectively undo or redo changes using a brush. To do this, start by duplicating the image; then, in the original, go back to the desired state in the image’s history, either by undoing or by using the Undo History dialog. (This must be done in the original, not the copy, because duplicating an image does not duplicate the Undo history.) Now activate the Clone tool, setting Source to “Image source” and Alignment to “Registered”. **Ctrl**-click on a layer from one image, and paint on the corresponding layer from the other image. Depending on how you do it, this gives you either an “undo brush” or a “redo brush”.

14.3.13 Heal

Figure 14.96 The “Heal tool” in the Toolbox




This tool was once described as “The healing brush looks like a smart clone tool on steroids”. And indeed the Healing Tool is a close relative to the Clone Tool, but it is more smart to remove small failures in images. A typical usage is the removal of wrinkles in photographs. To do so, pixels are not simply copied from source to destination, but the area around the destination is taken into account before cloning is applied. The algorithm used for this, is described in a scientific paper by Todor Georgiev [GEORGIEV01].

To use it, first choose a brush with a size adapted to the defect. Then **Ctrl**-click on the area you want to reproduce. Release the **Ctrl** key and drag the sample to the defect. Click. If the defect is slight, not very different from its surrounding, it will be corrected as soon. Else, you can correct it with repeated clicks, but with a risk of daubing.

14.3.13.1 Activating the Tool

There are different possibilities to activate the tool:

- From the image-menu: Tools → Paint tools → Heal,
- or by clicking the tool icon:  in the Toolbox,
- or by clicking on the **H** keyboard shortcut.

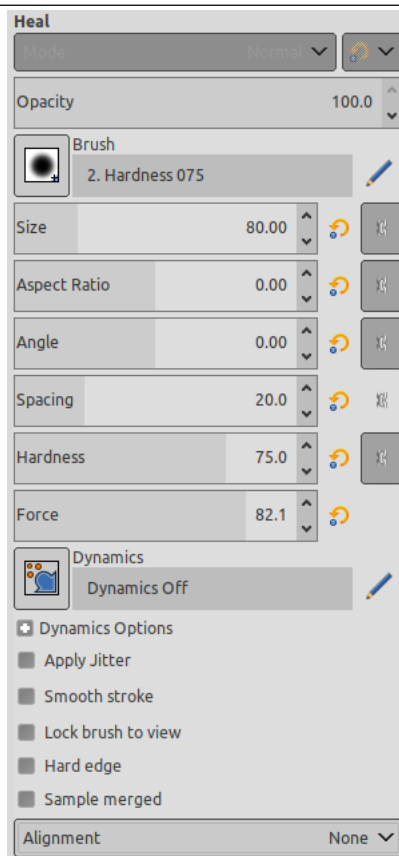
14.3.13.2 Key modifiers (Defaults)

Ctrl The **Ctrl** key is used to select the source. You can heal from any layer of any image, by clicking on the image display, with the **Ctrl** key held down, while the layer is active (as shown in the Layers dialog). If Alignment is set to “Non-aligned” or “Aligned” in Tool Options, then the point you click on becomes the origin for healing: the image data at that point will be used when you first begin painting with the Heal tool. In source-selection mode, the cursor changes to a crosshair-symbol.

Shift Once the source is set, if you press this key, you will see a thin line connecting the previously clicked point with the current pointer location. If you click again, while going on holding the **Shift** key down, the tool will “heal” along this line.

14.3.13.3 Options

Figure 14.97 Heal Tool options



Normally, tool options are displayed in a window attached under the Toolbox as soon as you activate a tool. If they are not, you can access them from the image menu bar through Windows → Dockable Windows → Tool Options which opens the option window of the selected tool.

Mode; Opacity; Brush; Size; Aspect Ratio; Angle; Spacing; Hardness; Dynamics; Dynamics Options; Force; Appl
See the [Common Paint Tool Options](#) for a description of tool options that apply to many or all paint tools.

Hard edge: this option gives a hard contour to the healed area.

Sample merged If you enable this option, healing is not calculated only from the values of the active layer, but from all visible layers.

See Section [14.3.12](#) for using Sample Merged in non-destructive image editing.

Alignment This option is described in [Clone tool](#).

14.3.13.4 Healing is not cloning

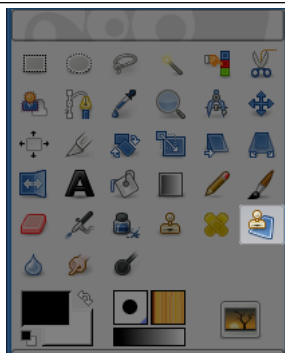
Although the Heal tool has common features with the Clone tool on using, the result is quite different.

Figure 14.98 Comparing “Clone” and “Heal”

Cloning on the left. All colors are transferred.

Healing on the right. Colors are much less transferred, especially on borders where surrounding pixels of destination are taken in account.

14.3.14 Perspective Clone

Figure 14.99 The “Perspective Clone” tool in the Toolbox

This tool allows you to clone according to the perspective you want. First, set the wanted vanishing lines in the same way as with the **Perspective** tool. Then copy the source area in the same way as with the **Clone** tool.

14.3.14.1 Activating the Tool

There are different possibilities to activate the tool:

- From the image-menu: Tools → Paint tools → Perspective Clone.

- The Tool can also be called by clicking the tool icon:  in the Toolbox.

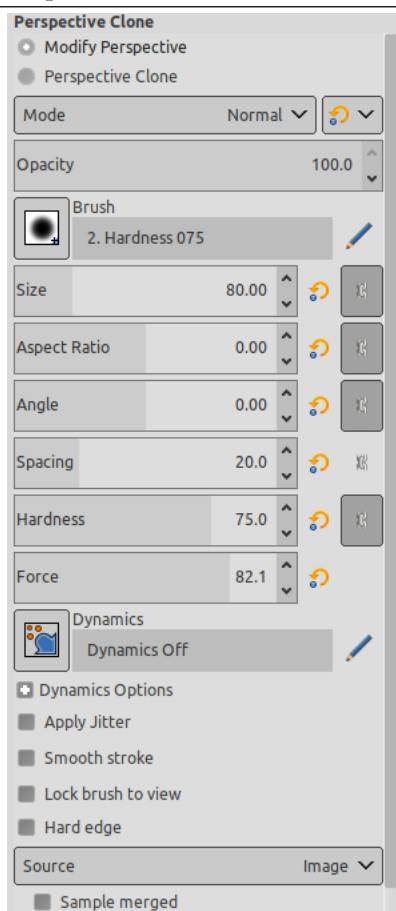
14.3.14.2 Key modifiers (Defaults)

Ctrl Ctrl-click allows you to select a new clone source.

Shift When the source is set and you press this key, you will see a thin line connecting the previously clicked point with the current pointer location. If you click again, while continuing to hold down the **Shift** key, the tool will clone along this line. Particularly useful when cloning from a pattern.

14.3.14.3 Options

Figure 14.100 Perspective Clone tool options



Normally, tool options are displayed in a window attached under the Toolbox as soon as you activate a tool. If they are not, you can access them from the image menu bar through **Windows → Dockable Windows → Tool Options** which opens the option window of the selected tool.

Operating mode When using this tool you first have to choose **Modify Perspective**. This works like the tool **perspective**. Then you choose **Perspective Clone** and use this in the same way as the **Clone** tool.

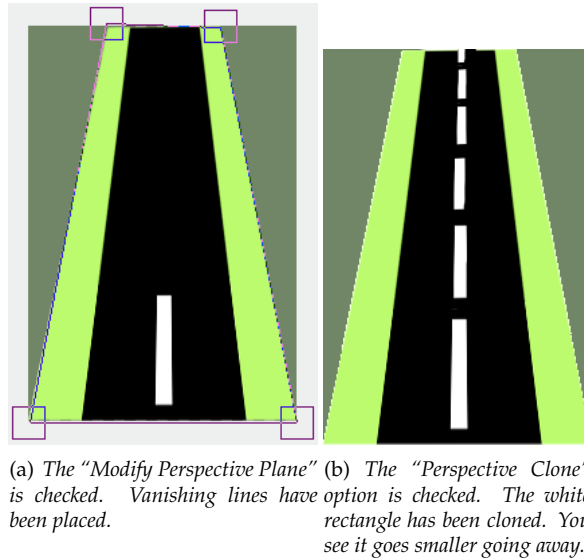
Mode; Opacity; Brush; Size; Aspect Ratio; Angle; Spacing; Hardness; Dynamics; Dynamics Options; Force; Appl
See the **Common Paint Tool Options** for a description of tool options that apply to many or all paint tools.

Hard edge: this option gives a hard contour to the cloned area.

Source, Alignment This are the same as in the tool **Clone**.

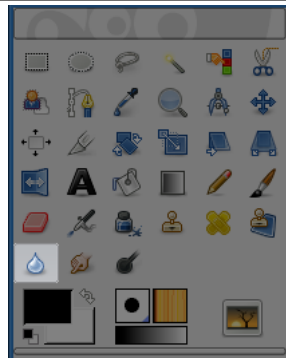
14.3.14.4 Example

Figure 14.101 “Perspective Clone” example



14.3.15 Blur/Sharpen

Figure 14.102 Blur/Sharpen tool icon in the Toolbox



The Blur/Sharpen tool uses the current brush to locally blur or sharpen your image. Blurring with it can be useful if some element of your image stands out too much, and you would like to soften it. If you want to blur a whole layer, or a large part of one, you will probably be better off using one of the **Blur Filters**. The direction of a brushstroke has no effect: if you want directional blurring, use the Smudge tool.

In “Sharpen” mode, the tool works by increasing the contrast where the brush is applied. A little bit of this may be useful, but over-application will produce noise. Some of the **Enhancement Filters**, particularly the **Unsharp Mask**, do a much cleaner job of sharpening areas of a layer.


Tip

You can create a more sophisticated sharpening brush using the Clone tool. To do this, start by duplicating the layer you want to work on, and run a sharpening filter, such as Unsharp Mask, on the copy. Then activate the Clone tool, and in its Tool Options set Source to “Image source” and Alignment to “Registered”. Set the Opacity to a modest value, such as 10. Then **Ctrl**-click on the copy to make it the source image. If you now paint on the original layer, you will mix together, where the brush is applied, the sharpened version with the unsharpened version.

Both blurring and sharpening work incrementally: moving the brush repeatedly over an area will increase the effect with each additional pass. The Rate control allows you to determine how quickly the modifications accumulate. The Opacity control, however, can be used to limit the amount of blurring that can be produced by a single brushstroke, regardless of how many passes are made with it.

14.3.15.1 Activating the Tool

There are different possibilities to activate the tool:

- From the image-menu: Tools → Paint tools → Blur/Sharpen.
- The Tool can also be called by clicking the tool icon:  in the Toolbox.
- By using the keyboard shortcut Shift-U.

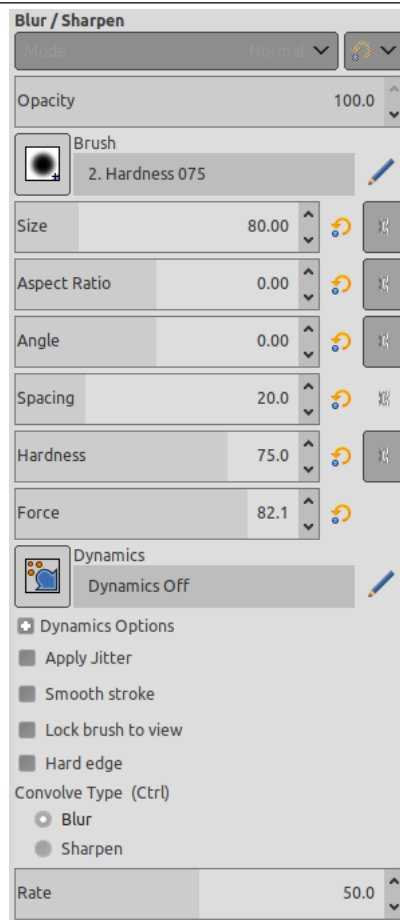
14.3.15.2 Key modifiers (Defaults)

See the [Paint Tools' Common Features](#) for a description of key modifiers that have the same effect on all paint tools.

Ctrl Holding down the **Ctrl** key toggles between Blur and Sharpen modes; it reverses the setting shown in the Tool Options.

14.3.15.3 Options

Figure 14.103 Tool Options for the Blur/Sharpen tool



Normally, tool options are displayed in a window attached under the Toolbox as soon as you activate a tool. If they are not, you can access them from the image menu bar through Windows → Dockable Windows → Tool Options which opens the option window of the selected tool.

Mode; Opacity; Brush; Size; Aspect Ratio; Angle; Spacing; Hardness; Dynamics; Dynamics Options; Force; Apply Jitter

See the [Common Paint Tool Options](#) for a description of tool options that apply to many or all paint tools.

Hard edge: this option gives a hard contour to the blurred/sharpened area.

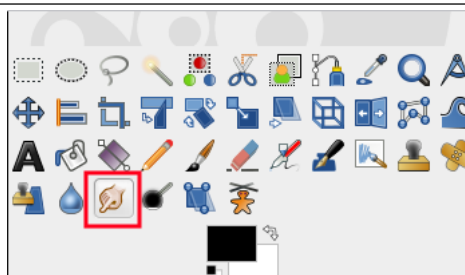
Convolve Type *Blur* mode causes each pixel affected by the brush to be blended with neighboring pixels, thereby increasing the similarity of pixels inside the brushstroke area. *Sharpen* mode causes each pixel to become more different from its neighbors than it previously was: it increases contrast inside the brushstroke area. Too much Sharpen ends in an ugly flocculation aspect. Whatever setting you choose here, you can reverse it on-the-fly by holding down the **Ctrl** key.

“Convolve” refers to a mathematical method using matrices.

Rate The Rate slider sets the strength of the Blur/Sharpen effect.

14.3.16 Smudge

Figure 14.104 Smudge tool




The Smudge tool evokes finger painting . With GIMP-2.10, it works in two ways:

- If the Flow option is set to 0.00 (default), the Smudge tool uses the current brush to smudge colors on the active layer or a selection. It takes color in passing and uses it to mix it to the next colors it meets.
- When the Flow option is more than 0.00, the Smudge tool works as a brush using the foreground color of the toolbox and blend it with the underlying color.

14.3.16.1 Activating the Tool

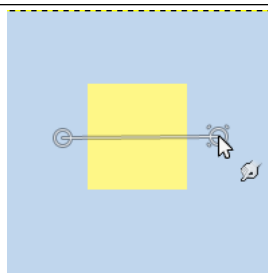
You can find the Smudge tool in various ways :

- through Tools → Paint Tools → Smudge in the image menu,
- by clicking on the tool icon:  in Toolbox,
- or by pressing the **S** key on keyboard.

14.3.16.2 Key modifiers (Defaults)

Shift The **Shift** key places the smudge tool into straight line mode. Holding **Shift** while clicking the mouse Left Button will smudge in a straight line. Consecutive clicks will continue smudging in straight lines that originate from the end of the last line.

Figure 14.105 Smudge tool

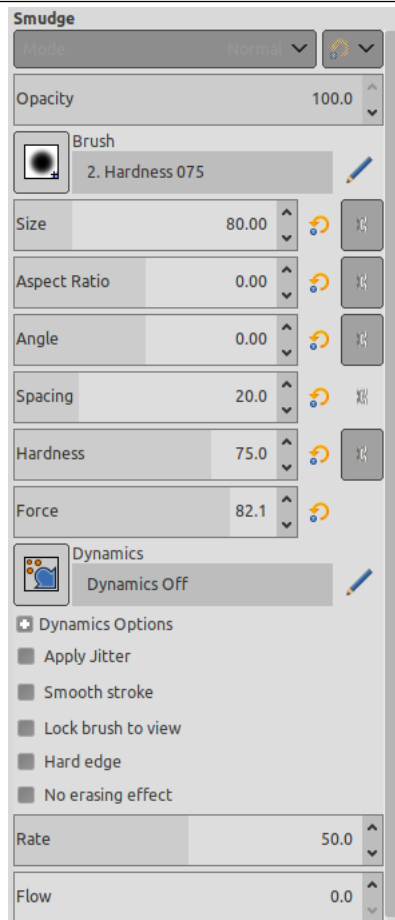


Shift click and drag to create line

Ctrl Using **Ctrl** with **Shift**, you can constrain the angle between two successive lines to vary by steps of 15°.

14.3.16.3 Options

Figure 14.106 Smudge Options



Normally, tool options are displayed in a window attached under the Toolbox as soon as you activate a tool. If they are not, you can access them from the image menu bar through Windows → Dockable Windows → Tool Options which opens the option window of the selected tool.

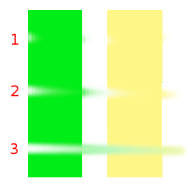
Opacity; Brush; Size; Aspect ratio; Angle; Spacing; Hardness; Force; Dynamics; Dynamics Options; Apply Jitter; Smooth stroke;

See the **Common Paint Tool Options** for a description of tool options that apply to many or all paint tools.

Hard edge: this option gives a hard contour to the smudged area.

Rate This option could be called "Smudge length" since it sets the length of the smudging effect in a stroke.

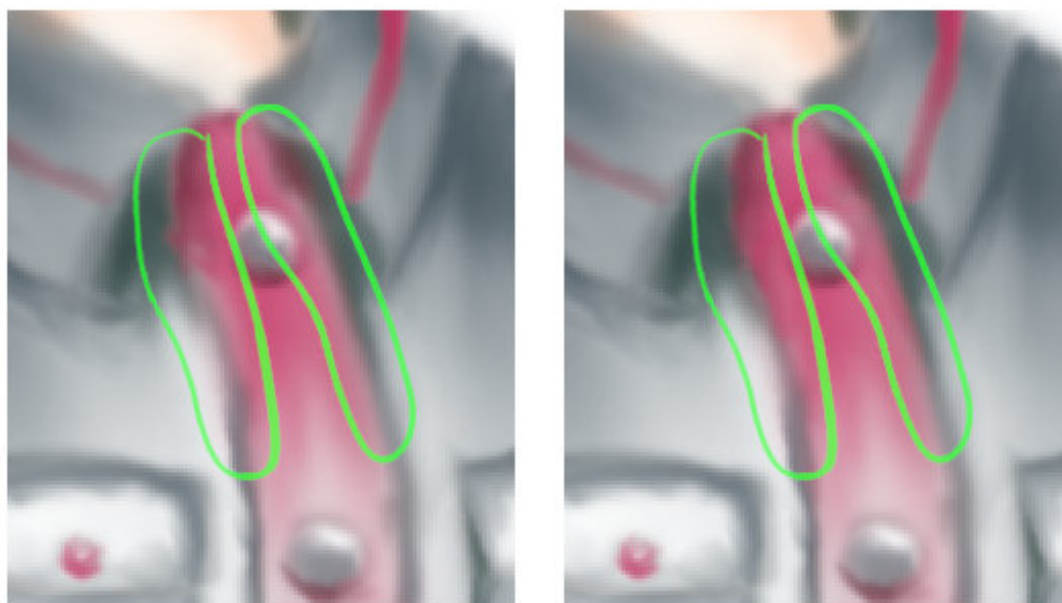
Figure 14.107 Rate example



1: Rate=20 2: Rate=60 3: Rate=90

No erasing effect If smudging will decrease alpha of some pixels; this alpha is not decreased if this option is checked, and so pixels are not erased. This is useful to fill a gap between two color areas.

Figure 14.108 An example of “No erasing” from the programmer



Without "No erasing effect"

With "No erasing effect"

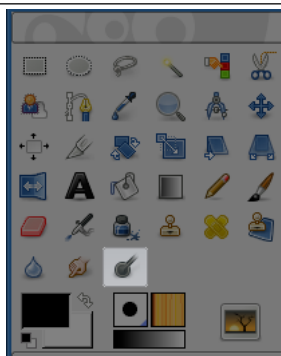
Flow We already saw the different behavior of the “Flow” option when it is set to 0.00 (works as the original Smudge tool) and set to more than 0.00 (uses the foreground color for smudging).

“No erasing effect” and “Flow” are new options in GIMP-2.10. Here are comments and examples from the programmer of these options in gimp-forum.net:



14.3.17 Dodge/Burn


Figure 14.109 Dodge tool



The Dodge or Burn tool uses the current brush to lighten or darken the colors in your image. The mode will determine which type of pixels are affected.

14.3.17.1 Activating the Tool

There are different possibilities to activate the tool:

- From the image-menu: Tools → Paint Tools → Dodge / Burn.
- The Tool can also be called by clicking the tool icon:  ,
- or by using the Shift-D keyboard shortcut.

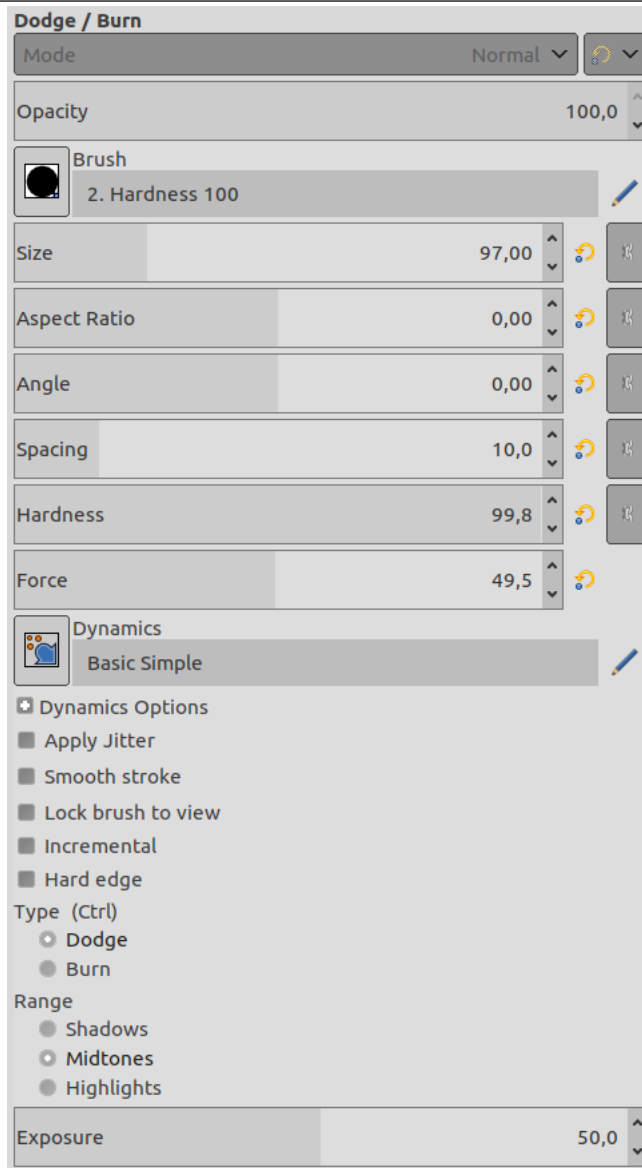
14.3.17.2 Key modifiers (Defaults)

Ctrl Toggle between dodge or burn types. The type will remain switched until **Ctrl** is released.

Shift **Shift** places the Dodge or Burn tool into straight line mode. Holding **Shift** while clicking the mouse Left Button will Dodge or Burn in a straight line. Consecutive clicks will continue Dodge or Burn in straight lines that originate from the end of the last line.

14.3.17.3 Options

Figure 14.110 “Dodge/Burn” tool options



Normally, tool options are displayed in a window attached under the Toolbox as soon as you activate a tool. If they are not, you can access them from the image menu bar through Windows → Dockable Windows → Tool Options which opens the option window of the selected tool.

Mode; Opacity; Brush; Size; Aspect Ratio; Angle; Spacing; Hardness; Dynamics; Dynamics Options; Force; Apply Jitter

See the [Common Paint Tool Options](#) for a description of tool options that apply to many or all paint tools.

Hard edge: this option gives a hard contour to the treated area.

Type The dodge effect lightens colors.

The burn effect darkens colors.

Range There are three modes:

- Shadows restricts the effect to darkest pixels.
- Midtones restricts the effect to pixels of average tone.
- Highlights restricts the effect to lightest pixels.

Exposure Exposure defines how much the tool effect will be strong, as a more or less exposed photograph. Default slider is 50 but can vary from 0 to 100.

14.4 Transform Tools

Figure 14.111 An overview of the transform tools

Align	Q
Move	M
Crop	Shift+C
Rotate	Shift+R
Scale	Shift+S
Shear	Shift+H
Perspective	Shift+P
Unified Transform	Shift+T
Handle Transform	Shift+L
Flip	Shift+F
Cage Transform	Shift+G
Warp Transform	W

14.4.1 Common Features

Inside the Transformation tool dialog, you will find eight tools to modify the presentation of the image or the presentation of an element of the image, selection, layer or path. Each transform tool has an Option dialog and an Information dialog to set parameters.

14.4.1.1 Tool Options

Some options are shared by several transform tools. We will describe them here. More specific options will be described with their tool.

Transform GIMP offers you three buttons which let you select which image element the transform tool will work on.

Note



Remember that the Transform option persists when you quit the tool.





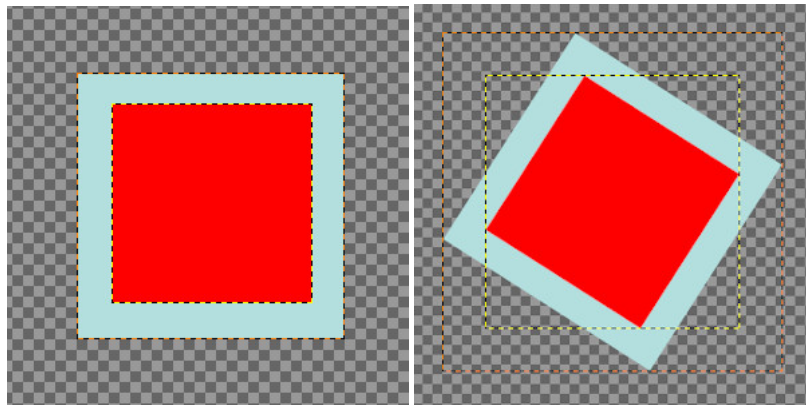
- When you activate the first button , the tool works on the active layer. If no selection exists in this layer, the whole layer will be transformed.
- When you activate the second button , the tool works on the selection contour only (the whole layer contour if no selection).
- When you activate the third button, , the tool works on the path only.
- When you activate the fourth button, new in GIMP-2.10.14, , the transformation is applied to all layers.

Figure 14.112 Example with Rotate

(a) Two layers, the red one being smaller. (b) Fourth button pressed, Rotate tool applied. View/Show All option checked. Note the adaptation of layer sizes.

Of course, you can get the same result linking layers, but this new option is easier to use.

Direction This option sets which way or direction a layer is transformed:

The “Normal (Forward)” mode will transform the image or layer as one might expect. You just use the handles to perform the transformation you want. If you use a grid (see below), the image or layer is transformed according to the shape and position you put the grid into.

“Corrective (Backward)” inverts the direction. Primarily used with the Rotation tool to repair digital images that have some geometric errors (a horizon not horizontal, a wall not vertical...). See Section 14.4.5.

With GIMP-2.10.10, you can link these two options in Rotate, Scale, Perspective, Unified transform and Handle transform tools. This allows moving handles without affecting the transformation, letting you manually readjust their position.

Interpolation This drop-down list lets you choose the method and thus the quality of the transformation:

None The color of each pixel is copied from its closest neighboring pixel in the original image. This often results in aliasing (the “stair-step” effect) and a coarse image, but it is the fastest method. Sometimes this method is called “Nearest Neighbor”.

Linear The color of each pixel is computed as the average color of the four closest pixels in the original image. This gives a satisfactory result for most images and is a good compromise between speed and quality. Sometimes this method is called “Bilinear”.

Cubic The color of each pixel is computed as the average color of the eight closest pixels in the original image. This usually gives a good result, but it naturally takes more time. Sometimes this method is called “Bicubic”.

LoHalo, NoHalo Halo is an artifact that can be created by interpolation. It remembers the halo you can get when using Section 17.4.8. Here is a note from Nicolas Robidoux, the creator of the new quality samplers for GEGL and GIMP:

```

    "If haloining is not an issue with your content and use ←
      case,
    which of the two should you try first?
    (Clearly, if you want to minimize haloining, NoHalo is ←
      the
    ticket.)

    If you are reducing an image, LoHalo is generally ←
      better.

    If your transformation is not an all around reduction, ←
      for
    example if you enlarge, rotate or apply a perspective
  
```


transformation that keeps portions of the image at the same or higher resolution, I generally prefer NoHalo. This preference, however, changes depending on the image content. If, for example, the image contains text or text-like objects or has significant areas with only a handful of different colours, like old school pixel art, I'd switch to LoHalo. Likewise if the image is quite noisy or marred by compression artifacts (as are most JPEGs found on the web). Conversely, if the image is noise free, very slightly blurry (meaning that when pixel peeking, the lines and interfaces are smeared over two or more pixels), and there are delicate skin tones to be preserved, I'd try NoHalo first. Actually, if I find that colours have not been preserved nicely after transforming an image with LoHalo, I'd immediately switch to NoHalo, even if reducing.

In any case, these recommendations should not be taken as gospel. I still have much to learn and figure out. For example, how best to deal with transparency and different colour spaces is something I'm likely to be thinking about for a while."

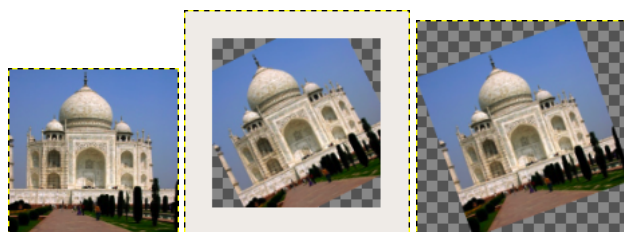
You can set the default interpolation method in the **Tools Options Preferences** dialog.

Clipping After transformation, the image can be bigger. This option will clip the transformed image to the original image size.

You can choose between several ways to clip:

Adjust

Figure 14.113 Original image for examples



(a) Original image (b) Rotation applied with "Adjust" (c) Rotation applied with "Adjust" and canvas enlarged to layer size

With Adjust: the layer is enlarged to contain all the rotated layer. The new layer border is visible; the whole layer becomes visible by using the Image → Fit Canvas to Layers command.

Clip

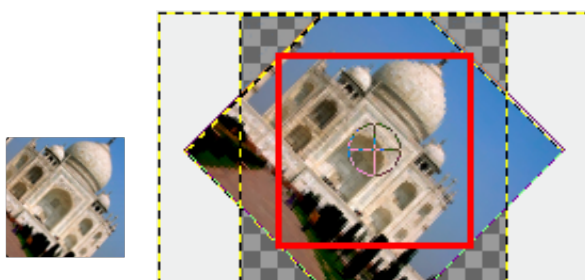
Figure 14.114 Example for Clip



Clip

With Clip: all what exceeds image limits is deleted.
Crop to result

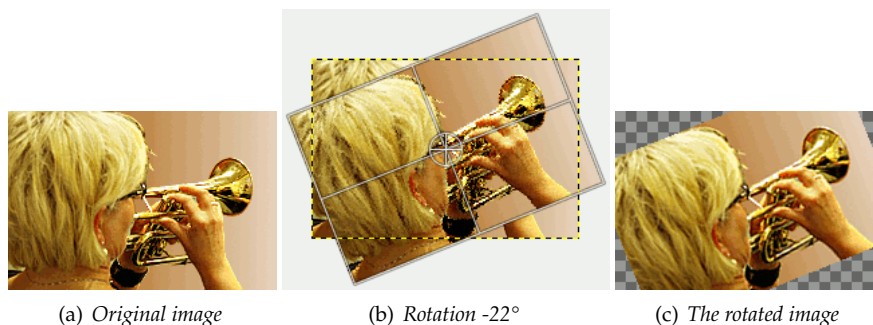
Figure 14.115 Example for Crop to result



(a) Rotation 45° (b) The crop limit is marked with red. No transparent area is included.

If this option is selected, the image is cropped so that the transparent area, created by the transform operation in corners, will not be included in the resulting image.
Crop with aspect

Figure 14.116 Example for Crop with aspect



(a) Original image

(b) Rotation -22°

(c) The rotated image

This option works like the one described before, but makes sure, that the aspect ratio is maintained.

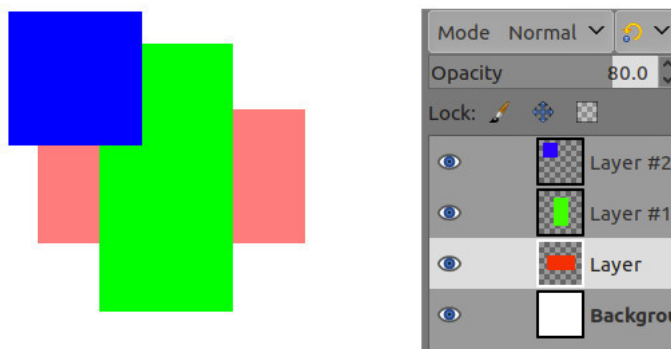
If this is marked, which is the default setting, the transformed image will be visible on top of the original image or layer. There will also be a slider with which you may select the preview opacity.

Show image preview as part of the image composition Inspired from <https://libregraphicsworld.org/blog/entry/gimp-2-10-18-full-review>

Show preview as part of the image composition: when you have multiple layers, each one with its own blending mode and opacity, transforming it means it pops up right above every other layer. So in

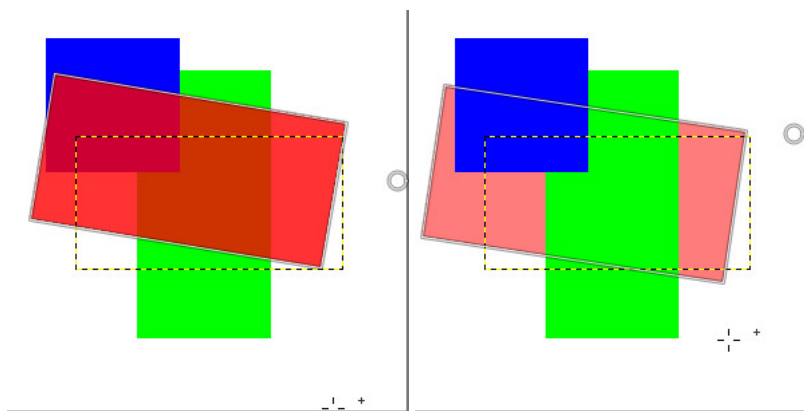
a complex layers composition you can't align this layer against other layers without much trial and error.

The new Composited Preview option removes this problem in favor of rendering the preview of the transformed layer exactly where it is in the layers stack, exactly with the opacity and blending mode of choice.



Original image: red layer opacity is 50%

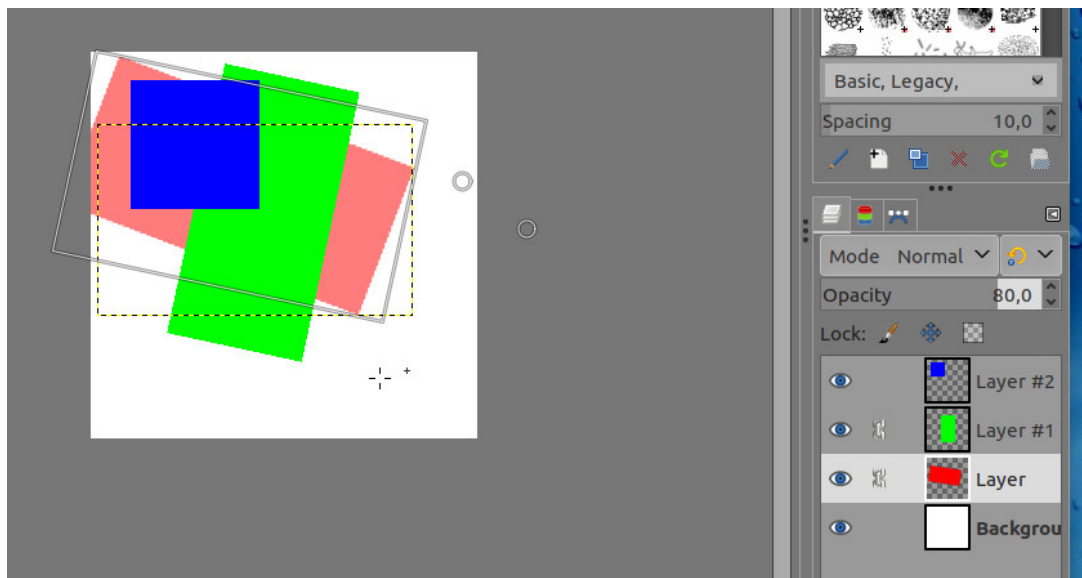
Figure 14.117 Composited Preview Example



(a) Composited option unchecked: in preview, (b) Composited option checked: in preview, red layer is above all other layers. red layer is at its right place, like in layer stack.

Two sub options are available:

- Preview linked items: display transformation of all linked layers rather than the currently selected one.



Two layers linked

- **Synchronous preview:** this option is experimental. The idea is to render the preview as soon as you change the transform. So instead of waiting for the mouse to stop moving, it renders the result immediately. If GIMP can render everything fast enough, this means a much smoother and more instant feedback.

But this option also blocks everything until the preview is done rendering. This means, GIMP can become much less responsive, usually when the layer is very large. That's why this is disabled by default.

Guides This is a drop down list where you select the type of guide lines which suits your transforming. All the guides uses a frame to mark the image's outline in addition to the lines used by the different selections.

No guides As the name tells you, there are no guides used.

Center lines Uses one vertical line and one horizontal line crossing each other in the center of the image or layer.

Rule of thirds Divides the transforming area in nine equal parts by adding two horizontal lines and two vertical lines equally spaced. According to this rule the most interesting parts of the image should be placed at the intersection points.

Rule of fifths Just as the "Rules of thirds" but divides the area in five by five parts.

Golden sections Also called "The Golden Ratio". This divides the transforming area in nine parts using a mathematical formula proportioning the parts to each others and to the area to be transformed.

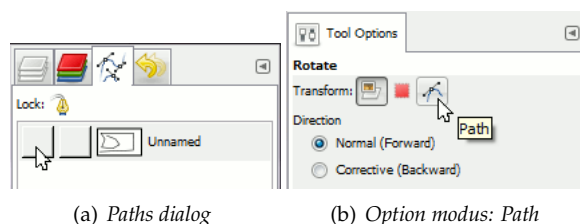
Diagonal lines Divide the transforming area using diagonally lines.

Number of lines Puts a rectangular grid with equal numbers of vertically and horizontally lines. The number of lines is set in the slider popping up when this guide is selected.

Line spacing Puts a rectangular grid on the transforming area using the spacing between the lines set in the slider.

14.4.1.2 Transforming Paths

If you for some reason want to transform paths, it is possible to do this using the transform tools.

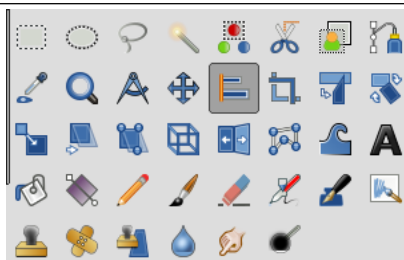
Figure 14.118 Rotating paths

When the path is drawn go to the path dialog and click on the first field before the path outline in the dialog window to get the eye icon visible. Then choose the transformation tool and in the upper part of the option dialog click on the path icon to tell the tool to act on the path.

Do the transformation the usual way and confirm it when finished. It could be a good idea to set the Guides to "No guides" to get the path more recognizable.

When the transformation is finished, choose the path tool and click on the changed path to activate it again for further working on it.

14.4.2 Align

Figure 14.119 The Align tool in toolbox


The Align tool is useful to align the image layers with various image objects. When this tool is selected, the mouse pointer turns to a small hand. By clicking on an element of a layer in the image, you choose the layer which will be moved (with **Shift** + click, you can choose several layers to be aligned); this focused layer has small squares in corners and is called *source*. Then buttons in the dialog become active (they remain active during all the GIMP session): they allow you to select the *target*, i.e other layer, selection, path, the source will be aligned with.

14.4.2.1 Activating the Tool

You can activate the Align tool in several ways :

- from the image-menu, through: Tools → Transform Tools → Align,



- by clicking on the tool icon:  in the toolbox,
- by using the **Q** keyboard shortcut.

14.4.2.2 Key modifiers (Defaults)

Shift You can select several layers by holding **Shift** when clicking the layers.

Tip

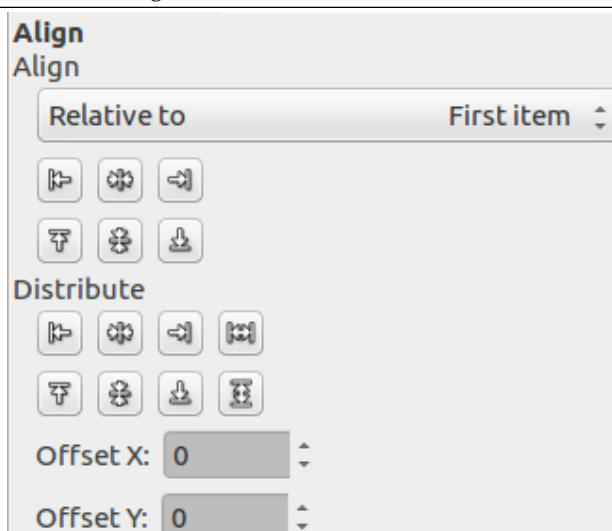


Sometimes it's easier to choose multiple layers using rubber-banding: click somewhere outside an imaginary rectangular region covering the layers you want to choose. Then drag out that region by moving the pointer, and release the mouse button. Now every layer, which is completely inside the dragged rectangle, is selected.

Note that now there is no target “first item” the selected layers can be aligned on.

14.4.2.3 Tool Options

Figure 14.120 Tool Options for the Align tool



Normally, tool options are displayed in a window attached under the Toolbox as soon as you activate a tool. If they are not, you can access them from the image menu bar through Windows → Dockable Windows → Tool Options which opens the option window of the selected tool.


Align

Relative to: In this drop down list, you select the target, the image object the layer will be aligned with.

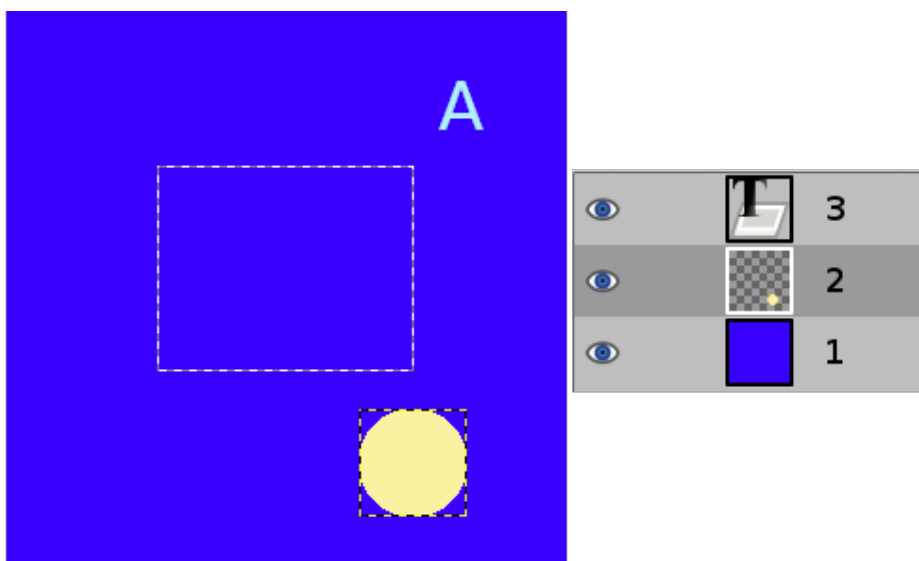
- First item: the first selected item when selecting multiple layers holding the **Shift** key. Note that there is no “first item” when you select multiple layers using rubber-banding.
- Image: the image is the target.
- Selection: the selection is the target.
- Active layer: the active layer, in the layer dialog, is the target.
- Active Channel: the active channel, containing a selection you made before, is the target.
- Active Path: the active path is the target.

Align buttons These buttons become active when a target is selected.

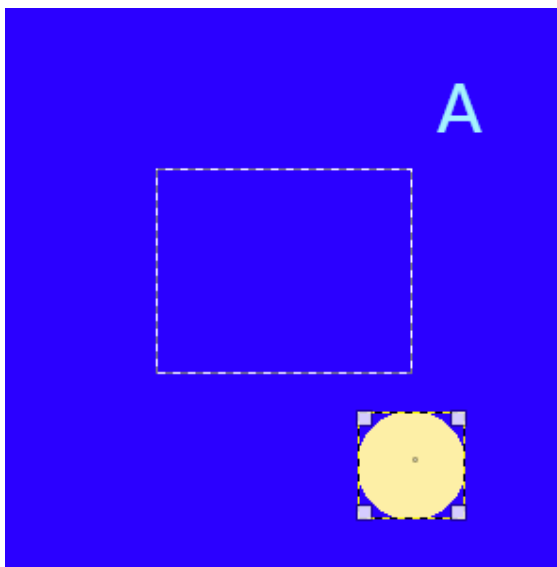
- Align left edge of target: to align left edge of source with left edge of target.
- Align center of target: to align center of source on the *vertical* middle line of target.
- Align right edge of target: to align right edge of source with right edge of target.
- Align top edge of target: to align top edge of source with top edge of target.
- Align middle of target: to align center of source on the *horizontal* middle line of target.

- : Align bottom edge of target: to align bottom edge of source with bottom edge of target.

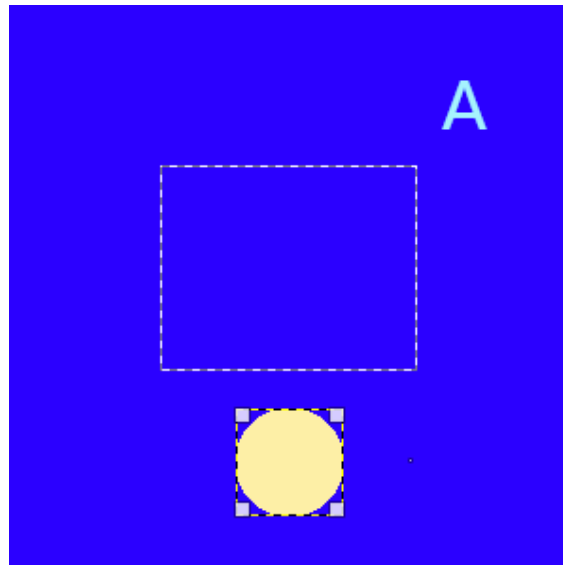
Example



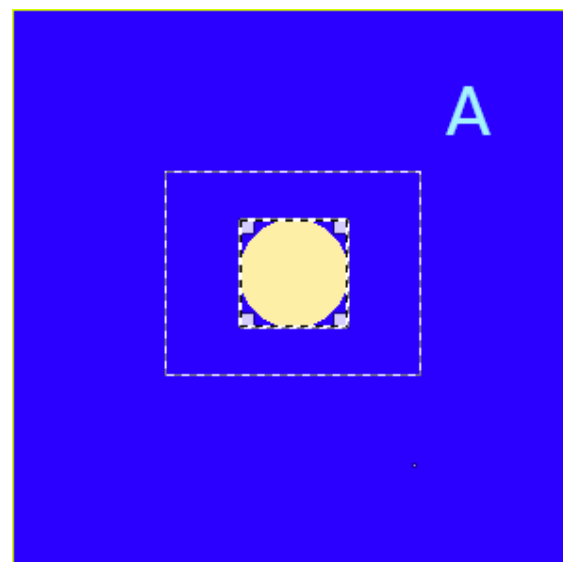
An image with a selection, layer #1 (background) is active, layer #2 is cropped to content, layer #3 is a text layer.



We click on the yellow circle: layer #2 becomes the source. We want to send this source to the middle of the selection: the Relative to option is set to "Selection".



Align center of target clicked











Align middle of target clicked

Distribute

Distribute buttons These options are used when you have several targets and want to arrange them. Here, layers selected with **Shift** + Click are called “targets” . But they are actually sources. “Relative to” options are active to set the target. These transformations are usually relative to “Image”.

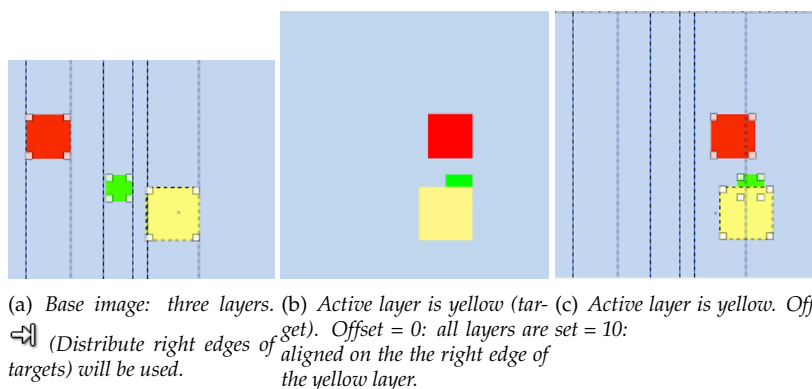
These options work as Align options, but you can add an offset and new options are available to distribute sources evenly.

- : Distribute left edges of targets: to distribute left edges of sources on the left edge of the target (the image).
- : Distribute horizontal centers of targets: to distribute centers of sources with center of the target horizontally.
- : Distribute right edges of targets: to distribute right edges of sources on right edge of the target.
- : Distribute targets evenly in the horizontal: to distribute sources evenly horizontally.
- : Distribute top edges of targets: to distribute top edges of sources on top edge of target.

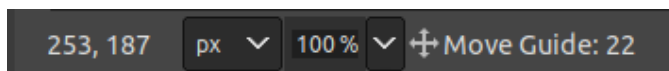
- : Distribute vertical centers of targets: to distribute centers of sources with center of target.
- : Distribute bottom edges of targets: to distribute bottom edges of sources with bottom edge of target.
- : Distribute targets evenly in the vertical: to distribute sources evenly vertically.

Offset This offset can be positive or negative and is expressed in pixels. Distribute add it to the left edges, horizontal centers, right edges, top edges, vertical centers, or bottoms of sources.

Figure 14.121 Example for the “Distribute” commands

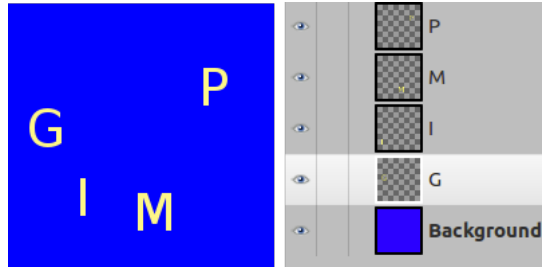


New feature in GIMP-2.10 GIMP-2.10 shows relative coordinates (horizontal or vertical) when moving guides and sample points. Coordinates are relative to the start of moving.

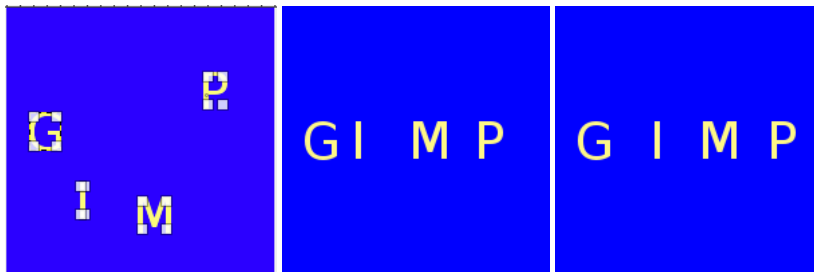


14.4.2.4 A practical example for “Distribute”

Figure 14.122 Origin



(a) Four text layers, with same size. We want to align them at center of image.



(b) We select them as sources with **Shift + Click**.

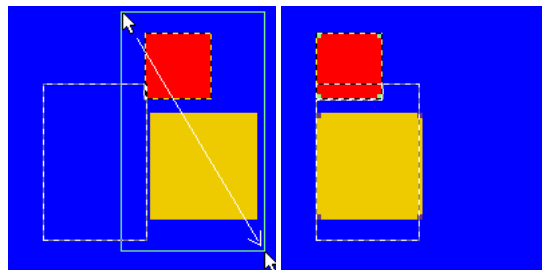
(c) The default target (Relative to) is “Image”. Offset = 0.

(d) After using the (Distribute targets

We used the (Distribute evenly in the horizontal) with vertical centers of targets) command. offset = 5.

14.4.2.5 Align using the rubber-band box

Figure 14.123 Align using rubber-band box

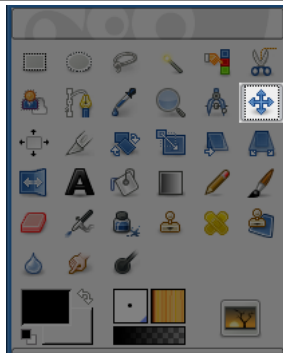


(a) We clicked left from and above the red layer, and dragged out a region covering the red and the yellow layer by moving the pointer towards the bottom right corner.

(b) “Selection” is the reference. After a click on the button, both layers align with the left side of the selection.

14.4.3 Move


Figure 14.124 The Move tool in Toolbox



The Move Tool is used to move layers, selections, paths or guides. It works also on texts.

14.4.3.1 Activating the Tool

You can access the Move Tool in different ways:

- From the image menu bar Tools → Transform Tools → Move,
- By clicking the tool icon:  .
- By using the keyboard shortcut **M**.
- The Move tool is automatically activated when you create a guide.

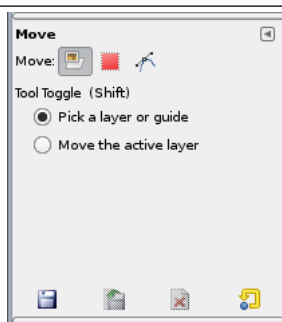
Note



Holding down the **Space** bar changes the active tool to Move temporarily. The Move tool remains active as long as the space bar is held down. The original tool is reactivated after releasing the space bar. This behavior exists only if the Switch to Move tool option is enabled in Edit → Preferences → Image Windows → Space Bar.

14.4.3.2 Options

Figure 14.125 Move Tool options



Normally, tool options are displayed in a window attached under the Toolbox as soon as you activate a tool. If they are not, you can access them from the image menu bar through Windows → Dockable Windows → Tool Options which opens the option window of the selected tool.

Move

Note



These options are described in [Transform tools common options](#).

Keep in mind that your Move choice persists after quitting the tool.

Tool toggle (Shift) If Move is on “Layer” 

Pick a layer or guide On an image with several layers, the mouse pointer turns to a crosshair when it goes over an element belonging to the current layer. Then you can click-and-drag it. If the mouse pointer has a small hand shape (showing that you do *not* pick an element of the active layer), you will move a non-active layer instead (it becomes the active layer while moving).

If a guide exists on your image, it will turn to red when the mouse pointer goes over. Then it is activated and you can move it.


At the point of intersection of two guides, you can click-and-drag to move them together. This is useful when the guides are used to mark a point, rather than a pair of lines (e.g. as is the case for the mandala symmetry guides, which mark the symmetry point of origin).

Move the active layer Only the current layer will be moved (if smaller than canvas). This may be useful if you want to move a layer with transparent areas, where you can easily pick the wrong layer through these transparent areas.


Note



You also can move the active layer by setting its offset in the Edit Layer Attributes dialog.

If Move is on “Selection” 

The selection’s outline will be moved (see Section [7.2.1](#)).

If Move is on “Path” 

Pick a path That’s the default option. The mouse pointer turns to a small hand when it goes over a **visible path**. Then you can move this path by click-and-dragging it (it will be the active path while moving).

Move the active path Only the current path will be moved. You can change the current path in the [Path Dialog](#).

14.4.3.3 Summary of Move tool actions

Moving a selection The Move tool allows to move the selection outline only. If the Move Mode is “Layer”, you must hold down Ctrl-Alt keys.

If the Move Mode is Selection, you can click-and-drag any point in canvas to move the selection outline. You can also use the arrow keys to move selections precisely. Then, holding down the **Shift** key moves then by increments of 25 pixels.

When you move a selection with the Move tool, the center of the selection is marked with a small cross. This cross and selection boundaries snap to guides or grid if the View → Snap to Guides (or Grid) option is checked: this makes aligning selections easier.

See [Moving selections](#) for other possibilities.

Moving a layer The Move Mode must be “Layer”. Then you can choose between Move the Active Layer and, if you have one or more layers, Point to Layer (or Guide).

Moving Grouped Layers If layers are grouped (with the little chain symbol) they will all move, regardless of which layer is currently active.

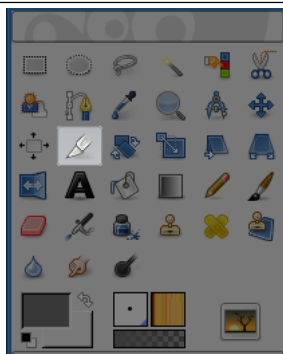
Moving a guide When you pull a guide from a ruler, the Move tool is automatically activated. That’s not the case after using another tool, and you have to activate it by yourself. When the mouse pointer goes over a guide, this guide turns to red and you can click-and-drag to move it.

Moving a path The Path Tool dialog has its own moving function: see Section [14.5.2](#). But you can also use the Move Tool. The Move Mode must be set to “Path”. Note that the path becomes invisible; make it visible in the Path Dialog. You can choose the path to be moved or move the active path.

Moving a text Every text has its own layer and can be moved as layers. See Section [14.5.6](#).

14.4.4 Crop

Figure 14.126 Crop tool



The Crop Tool is used to crop or clip an image. It works on all the layers of the image, visible and invisible. This tool is often used to remove borders, or to eliminate unwanted areas to provide you with a more focused working area. It is also useful if you need a specific image size that does not match the original dimensions of your image.

Just like the selection tools, the new crop tool has been enhanced with the v2.4 release. The resize handles actually resize the crop rectangle instead of providing both resize and move functionality. The tool behaves more naturally and consistently with other GIMP tools. To move, simply drag the rectangle clicking within the area. Resizing is possible in one or two axes at the same time dragging the handlebars on the sides and corners. The outside area can be darkened with a nice passepartout effect to better get the idea of how the final crop will look like. To validate cropping, click inside the crop rectangle or press the **Enter** key.

When the mouse becomes the moving cross-hair, you can use the keyboard arrow keys to move the crop rectangle. Holding the **Shift** key down allows to move by increments of 25 pixels.

You can use Guides to position the crop area. Make sure that the View → Snap to Guides option is checked.

Note




You can see the aspect ratio in the status bar:

124, 75 px | 100 % | Rectangle: 79 × 48 (1,65:1)

14.4.4.1 Activating the Tool

You can activate this tool in different ways:

- From the image menu bar Tools → Transform tools → Crop,
- by clicking the tool icon:  in the ToolBox,
- by using the keyboard shortcut Shift-C.

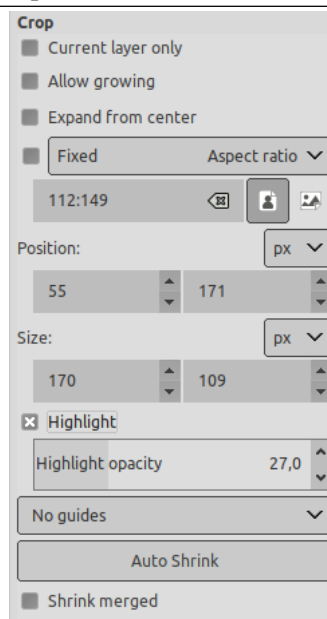
14.4.4.2 Key modifiers (Defaults)

When you maintain click on the crop rectangle, handles disappear and

- holding down the **Ctrl** key toggles to the Extend from Center option,
- holding down the **Shift** key toggles to the Fixed option, which makes some dimensions fixed.

14.4.4.3 Tool Options

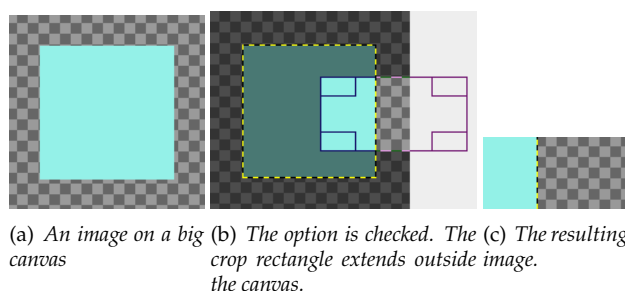
Figure 14.127 Tool Options for the “Crop” tool



Normally, tool options are displayed in a window attached under the Toolbox as soon as you activate a tool. If they are not, you can access them from the image menu bar through Windows → Dockable Windows → Tool Options which opens the option window of the selected tool.

Current Layer Only This option will make crop affect only the active layer.

Allow Growing This option allows the crop or resize to take place outside the image (or layer), and even the canvas. So, you can give the size you want to the resulting image. Transparency will be used if there is no material to crop.

Figure 14.128 Example for “Allow Growing”

Expand from Center When this option is checked, the crop rectangle expands from the first pixel you clicked taken for center. You can toggle this option with **Ctrl** while drawing the crop rectangle.

Fixed You can also access this option by holding down the **Ctrl** key while drawing the crop rectangle. This option offers you several to make drawing the crop rectangle respect fixed dimensions, or their ratio:

- **Aspect ratio:** That’s the default possibility. Width and Height keep the same ratio they have in the original image, when drawing the crop rectangle.
- **Width / Height:** Only Width or Height will remain fixed. The value of this dimension can be set in the text box below; it defaults to 100 pixels.
- **Size:** Both Width and Height will be fixed. Their values can be set in the text box below, in the form “150x100” for example. The crop rectangle will adopt this values as soon as you click the image. On the right, two buttons let you choose a Landscape (widthwise) or Portrait (upright) format for the crop rectangle.

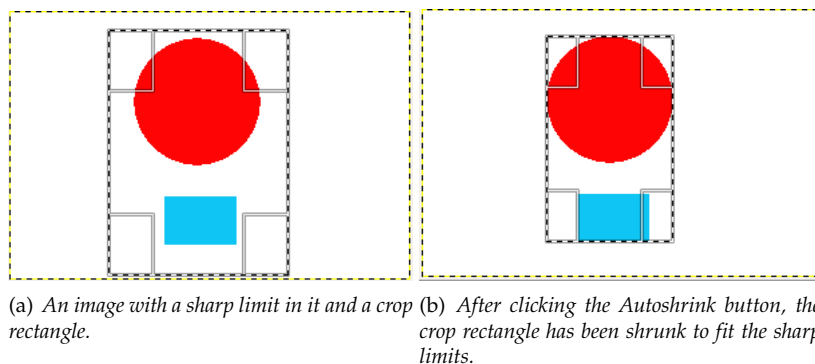
Position These two text boxes show the position (horizontal on the left, vertical on the right) of the upper left corner of the crop rectangle in real time and you can change it manually too. It is stated in pixels, but you can change the unit thanks to the drop-down list of the px button. The coordinate origin is the upper left corner of the canvas (not of the image).

Size These two text boxes show the size (horizontal on the left, vertical on the right) of the crop-rectangle in real time and you can change it manually too. It is stated in pixels, but you can change the unit thanks to the drop-down list of the px button.

Highlight This option toggles the dark outside area intended for highlighting the crop rectangle. The dark area opacity can be set using the Highlight opacity cursor.

Guides All kinds of guides are described in Section [14.2.2](#)

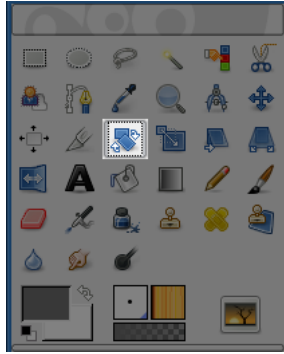
Autoshrink The Auto Shrink button will attempt to locate a border, in the active layer, from which to draw dimensions from. This option only works well with isolated objects contrasting sharply with background.

Figure 14.129 Example for “Autoshrink”

Shrink Merged This option works the same, with Auto Shrink or not. It uses the pixel information from all *visible* layers, rather than just from the active layer.

14.4.5 Rotate

Figure 14.130 The Rotate tool in Toolbox




14.4.5.1 Overview

This tool is used to rotate the active layer, a selection or a path. When you click on the image or the selection with this tool a *Rotation adjustment* dialog is opened. There, you can set the rotation axis, marked with a point, and the rotation angle. You can do the same by dragging the mouse pointer on the image or the rotation point.

14.4.5.2 Activating the Tool

You can access the Rotate Tool in different ways:

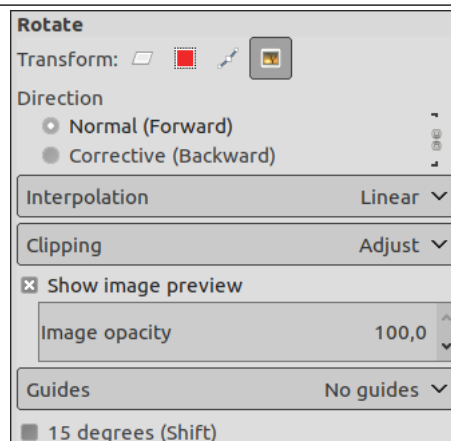
- from the image menu bar Tools → Transform Tools → Rotate,
- by clicking the tool icon:  in the Toolbox,
- by using the Shift-R key combination.

14.4.5.3 Key modifiers (Defaults)

Ctrl Holding **Ctrl** will constrain the rotation angle to 15 degrees increments.

14.4.5.4 Options

Figure 14.131 Rotation tool options



Normally, tool options are displayed in a window attached under the Toolbox as soon as you activate a tool. If they are not, you can access them from the image menu bar through Windows → Dockable Windows → Tool Options which opens the option window of the selected tool.

Transform; Direction, Interpolation; Clipping; Show image preview; Guides

Note



These options are described in [Transform tools common options](#).

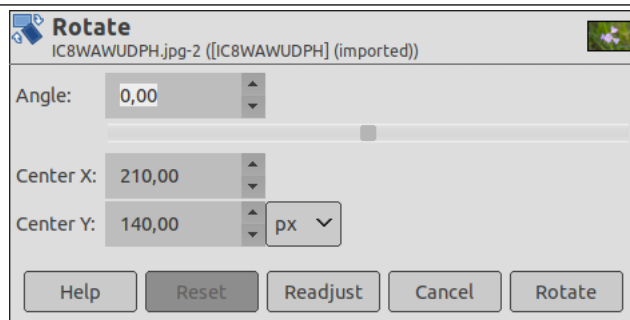
Transform Direction The Transform Direction sets which way or direction a layer is rotated. The Normal mode will rotate the layer as one might expect. If a layer is rotated 10 degrees to the right, then the layer will be rendered as such. This behavior is contrary to Corrective rotation.

Corrective Rotation is primarily used to repair digital images that are not straight. If the image is 13 degrees askew then you need not try to rotate by that angle. By using Corrective Rotation you can rotate visually and line up the layer with the image. Because the transformation is reversed, or performed backwards, the image will be rotated with sufficient angle to correct the error.

15 Degrees (Shift) 15 Degrees (Shift) will constrain the rotation to angles divisible by 15 degrees.

14.4.5.5 The Rotation adjustment dialog

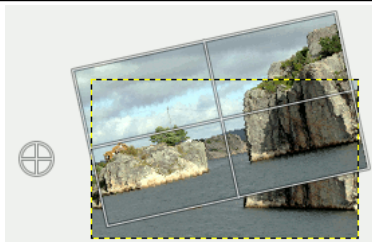
Figure 14.132 The Rotation adjustment dialog



Angle Here you can set the rotation angle, from -180° to $+180^\circ$, i.e. 360° .

Center X/Y This option allows you to set the position of the rotation center, represented by a cross surrounded by a circle in the image. A click-and-drag on this point also allows you to move this center even outside the image. Default unit of measurement is pixel, but you can change it by using the drop-down list.

Figure 14.133 The rotating center



The layer rotated around the rotating center outside the image

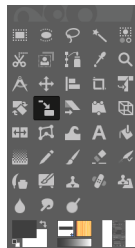
Readjust button With this button, new in GIMP-2.10.10, you can readjust transform handles based on the current zoom level.

Note

You can also rotate layers with Layer → Transform → Arbitrary Rotation...

14.4.6 Scale

Figure 14.134 The Scale tool in Toolbox


**14.4.6.1 Overview**

The Scale Tool is used to scale layers, selections or paths (the Object).

When you click on image with the tool the Scaling Information dialog box is opened, allowing to change separately Width and Height. At the same time a Preview (possibly with a grid or an outline) is superimposed on the object and handles appear on corners and borders that you can click and drag to change dimensions. At center, a square with a cross inside, to move the preview (mouse pointer is a moving cross then).

14.4.6.2 Activating the Tool

You can access the Scale Tool in different ways:

- from the image menu bar Tools → Transform Tools → Scale,
- by clicking the tool icon:  in the Toolbox,
- by using the Shift-S key combination.

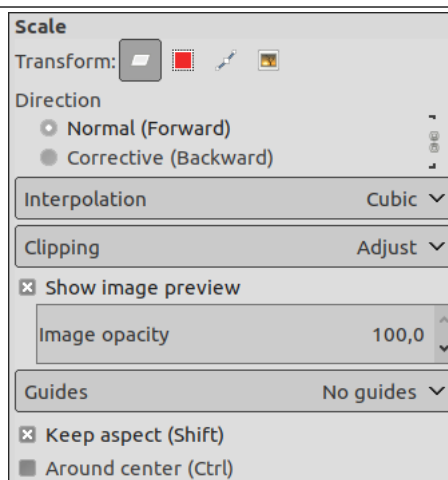
14.4.6.3 Key modifiers (Defaults)

Shift Holding the **Shift** key down will toggle the Keep aspect option.

Ctrl Holding the **Ctrl** key down will toggle the Around center option.

14.4.6.4 Tool Options

Figure 14.135 Tool options for the Scale tool



Normally, tool options are displayed in a window attached under the Toolbox as soon as you activate a tool. If they are not, you can access them from the image menu bar through Windows → Dockable Windows → Tool Options which opens the option window of the selected tool.

Transform; Interpolation; Direction; Clipping; Show image preview; Guides

Note



These options are described in [Transform tools common options](#).

Note



The Transform mode works on the active layer only. To work on all layers of the image, use [Scale Image](#).

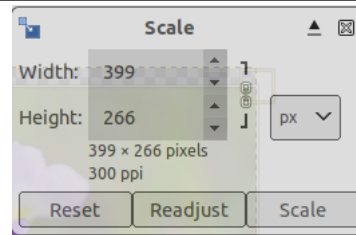
To scale a path, please refer to [Transforming path](#).

Keep aspect (Shift) When you move a corner of the selection frame, this option will constrain the scale such as the Height/Width ratio of the layer will remain constant. Note that this doesn't work with border handles. Note also that it toggles the linking chain in the dialog.

Around center (Ctrl) When this option is enabled, you can scale from center, radially if "Keep aspect" is checked, else vertically or horizontally.

14.4.6.5 The Scale adjustment dialog

Figure 14.136 The Scale adjustment dialog

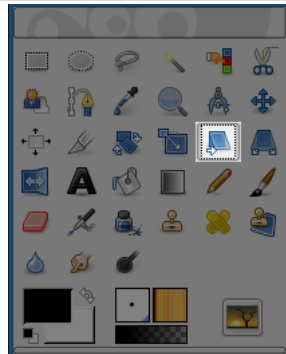


Width/Height Here, you can set Width and Height you want to give to the object. The default unit of measurement is pixel. You can change it by using the drop-down list. These values are also automatically changed when you drag handles in the image. If the associated linking chain is broken, you can change Width and Height separately.

Readjust button With this button, new in GIMP-2.10.10, you can readjust transform handles based on the current zoom level.

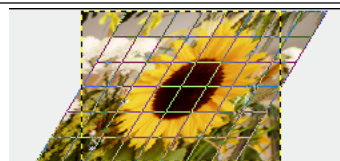
14.4.7 Shear

Figure 14.137 The Shear tool in Toolbox



Shear tool is used to shift one part of an image, a layer, a selection or a path to a direction and the other part to the opposite direction. For instance, a horizontal shearing will shift the upper part to the right and the lower part to the left. A rectangle becomes a diamond. This is not a rotation: the image is distorted. To use this tool after selecting, click on the image or the selection: a grid is possibly superimposed and the Shearing Information dialog is opened. By dragging the mouse pointer on the image you distort the image, horizontally or vertically according to the direction given to the pointer. When you are satisfied, click on the Shear button in the info dialog to validate.

Figure 14.138 Shear example




Note



You can't shear both ways at the same time, you have to use the shear tool twice on end.

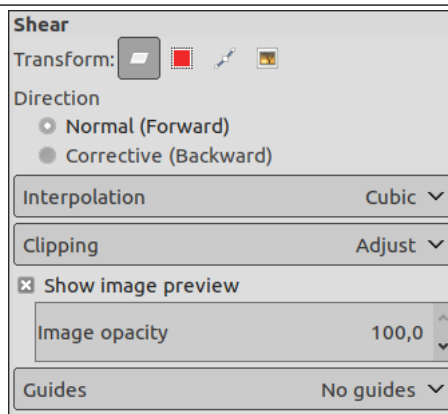
14.4.7.1 Activating the Tool

You can access the Shear Tool in different ways:

- from the image menu bar Tools → Transform Tools → Shear,
- by clicking on the tool icon:  in Toolbox,
- by using the Shift-S key combination.

14.4.7.2 Options

Figure 14.139 Shear tool options



Normally, tool options are displayed in a window attached under the Toolbox as soon as you activate a tool. If they are not, you can access them from the image menu bar through Windows → Dockable Windows → Tool Options which opens the option window of the selected tool.

Transform; Interpolation; Direction; Clipping; Show image preview; Guides

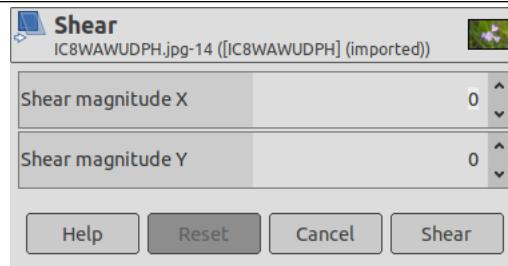
Note



These options are described in [Transform tools common options](#).

14.4.7.3 The Shear adjustment dialog

Figure 14.140 The Shear adjustment dialog

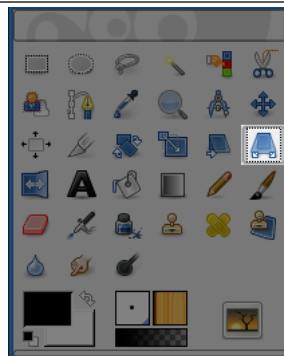


Shear magnitude X Here, you can set the horizontal shearing amplitude. A positive value produces a clock-wise tilt. A negative value gives a counter-clock-wise tilt. The unit used by shearing are half-pixels.

Shear magnitude Y As above, in the vertical direction.

14.4.8 Perspective

Figure 14.141 Perspective tool



The Perspective Tool is used to change the “perspective” of the active layer content, of a selection content or of a path. When you click on the image, according to the Preview type you have selected, a rectangular frame or a grid pops up around the selection (or around the whole layer if there is no selection), with a handle on each of the four corners. By moving these handles by click-and-drag, you can modify the perspective. At the same time, a “Transformation information” pops up, which lets you validate the transformation. At the center of the element, a circle lets you move the element by click-and-drag.

Note




This tool is not actually a perspective tool, as it doesn't impose perspective rules. It is better described as a distort tool.

14.4.8.1 Activating the Tool

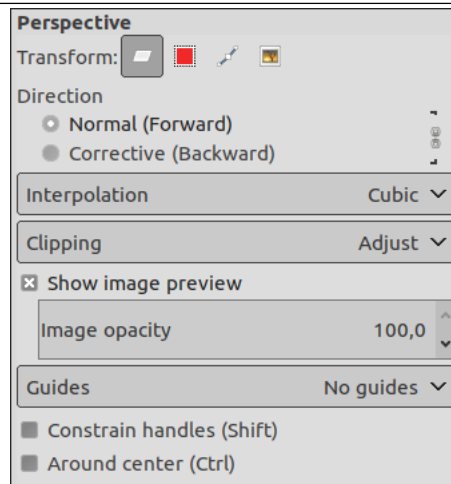
You can access the Perspective tool in different ways:

- From the image menu bar Tools/ Transform Tools Perspective,

- By clicking the tool icon:  in Toolbox,
- By using the Shift-P key combination.

14.4.8.2 Options

Figure 14.142 “Perspective” tool options



Normally, tool options are displayed in a window attached under the Toolbox as soon as you activate a tool. If they are not, you can access them from the image menu bar through Windows → Dockable Windows → Tool Options which opens the option window of the selected tool.

Transform; Interpolation; Direction; Clipping; Show image preview; Guides

Note



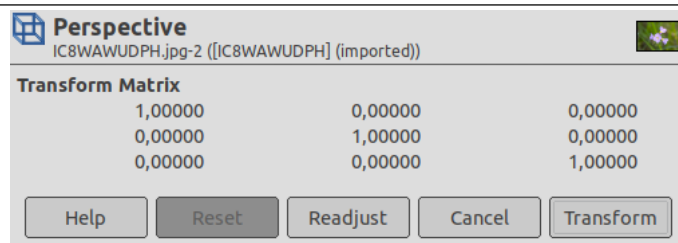
These options are described in [Transform tools common options](#).

Constrain handles (Shift) Constrain handles to move along edges and diagonal.

Around center (Ctrl) Transform around the center point.

14.4.8.3 The Shear adjustment dialog

Figure 14.143 The Shear adjustment dialog



Matrix The information window shows a mathematical representation of the perspective transformation. You can find more information about transformation matrices on [Wikipedia](#).

Readjust button With this button, new in GIMP-2.10.10, you can readjust transform handles based on the current zoom level.


14.4.9 3D Transform

The 3D Transform tool allows you to change the perspective of a layer and to move it in 3D space. You can set a vanishing point, then rotate the layer in X, Y, and Z axes.

It offers the usual option dialog under Toolbox and an on-canvas settings dialog.

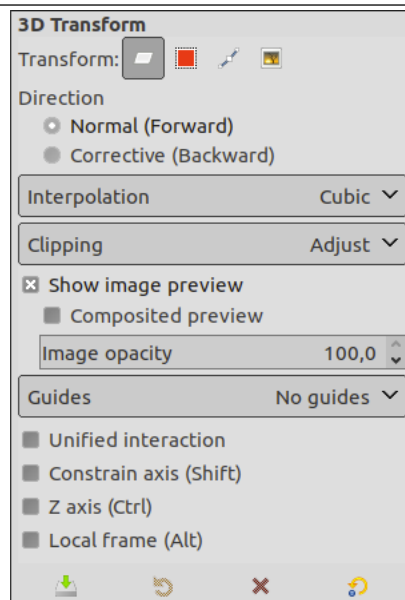
14.4.9.1 Activating the Tool


There are different possibilities to activate the tool:

- From the image-menu: Tools → Transform Tools → 3D Transform
- The Tool can also be called by clicking the tool icon in Toolbox: 
- or by clicking on the Shift-W keyboard shortcut.

14.4.9.2 Options

Figure 14.144 3D Transform Tool Options



The available tool options can be accessed by double clicking the Unified Transform tool icon: 

Shared options

Note

See Section 14.4.1 for a description of tool options that apply to many or all transform tools:

- Transform
- Direction
- Interpolation
- Clipping
- Direction
- Composited preview
- Guides



Unified interaction This option allows shifting the vanishing, as well as panning and rotating without switching between tabs on the on-canvas settings dialog.

Constrain axis (Shift) When you press **Shift**, the present transformation axis becomes fixed in preview.

Z axis (Ctrl) When you press **Ctrl**, transformation is done around the Z axis.

Local frame (Alt) This option allows controlling the transformation in the layer local frame of reference (the current layer), instead of the global one (all layers).

14.4.10 Unified Transform

Figure 14.145 Unified Transform tool





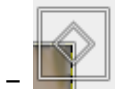
This tool combines several tools: **Rotate**, **Scale**, **Shear** and **Perspective**, performing one or several of these actions at once in one single operation. Combining two or more options gives you almost infinite possibilities of transformation.

As the other transformation tools, this tool works on the active layer (default).

After selecting the Unified Transform tool in the toolbox, click on the image window. Several elements appear on the image window:

- Several kinds of **handles**, on the edges:

-  Diamonds for shearing
-  Squares for scaling.



- Small diamonds for changing perspective, in large squares for Scaling.

Click and drag a handle to perform the action of the concerned tool

- A **circle with a cross inside** at the center of the image window for the pivot. Click and drag this circle to move the pivot. It can be placed out of the image window, and even where you want on screen (but you can no longer see it, unless you enlarge the image window).
- The **mouse pointer** comes with small icons which vary according to position:
 - *On the layer*: Move icon,
 - *Outside the layer*: Rotate icon,
 - *On handles*: Shear or perspective or Scale icon,
 - *On rotation center circle*: Move icon and Rotation icon.
- The **status bar**, at the bottom of the image window, displays the name of the current tool.
- When you click on the image window, also appears the **Matrix** new window:




where you find the Reset (very useful when testing), Cancel and Transform buttons. This matrix window appears out of the image or, if the image window is large enough, inside the image window. You cannot edit the values of this matrix, but you can note them to reproduce the same transformation later.

Readjust button: with this button, new in GIMP-2.10.10, you can readjust transform handles based on the current zoom level.

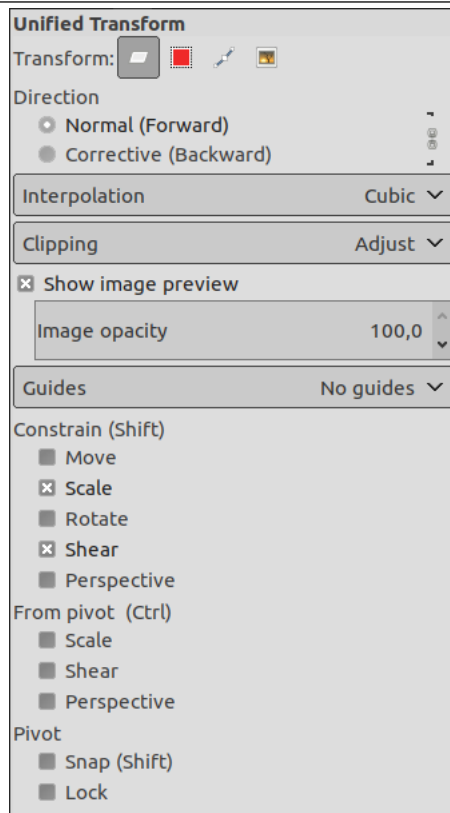
14.4.10.1 Activating the Tool


There are different possibilities to activate the tool:

- From the image-menu: Tools → Transform Tools → Unified transform
- The Tool can also be called by clicking the tool icon: 
- or by clicking on the Shift-L keyboard shortcut.

14.4.10.2 Options

Figure 14.146 Unified Transform Tool Options



The available tool options can be accessed by double clicking the Unified Transform tool icon. 

Shared options

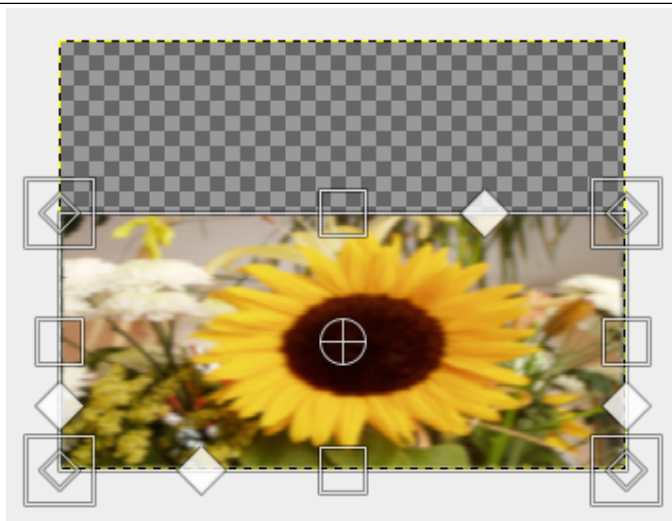
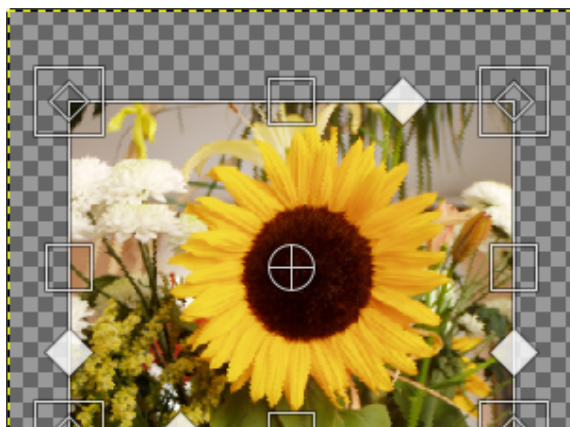
Note



See Section 14.4.1 for a description of tool options that apply to many or all transform tools.

Constrain Move: when this option is unchecked, moving the layer is smooth. Checking the option constrains movement to 45° from center.

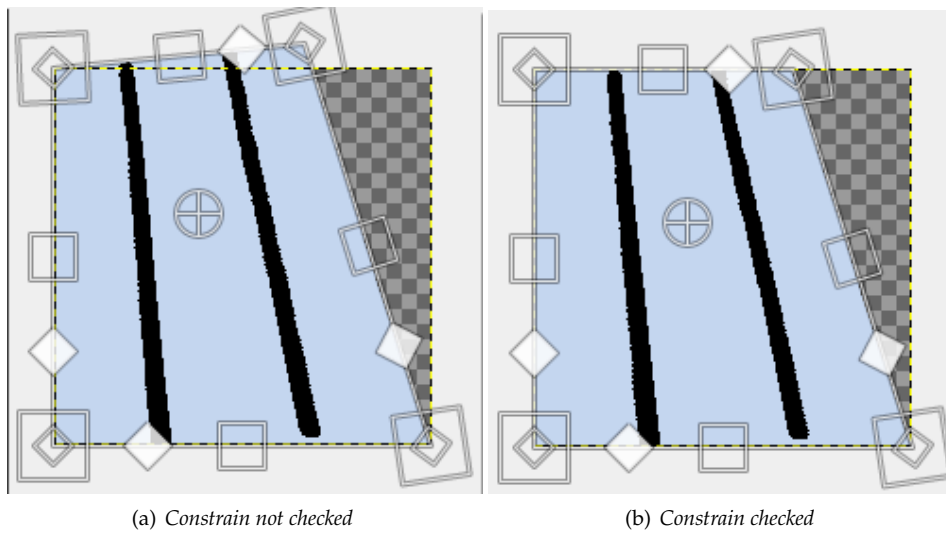
Scale: when this option is checked, the aspect ratio is preserved.

Figure 14.147 Scale Constraint Option(a) *Constrain not checked (no pivot)*(b) *Constrain checked (no pivot)*

Rotate: default rotation is smooth. When this option is checked, rotation goes by 15° steps.

Shear: normally, to shear the layer, you drag the corresponding icon along a layer edge. If this option is unchecked (default), you may move away from this edge. If this option is checked, shear handles remain on this edge.

Perspective: normally, to change perspective, you drag the corresponding icon along a layer edge. If this option is unchecked (default), you may move away from this edge. If this option is checked, perspective handles remain on this edge or on a diagonal.

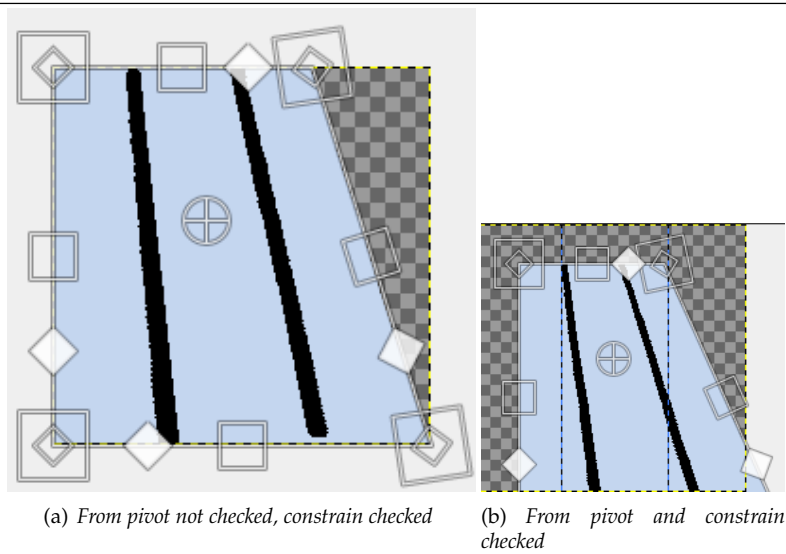
Figure 14.148 Perspective Constraint Option

From pivot Scale:

Figure 14.149 Scale from pivot

Shear: When this option is unchecked (default), the opposite edge is fixed and the pivot moves with shearing. When the option is checked, shearing is performed around a fixed pivot and the opposite side is sheared by the same amount, but in the opposite direction.

Perspective: when this option is checked, the position of pivot is maintained.

Figure 14.150 Perspective from pivot

Pivot Snap: if this option is checked, the pivot snaps to center or to corners when it comes close to them.

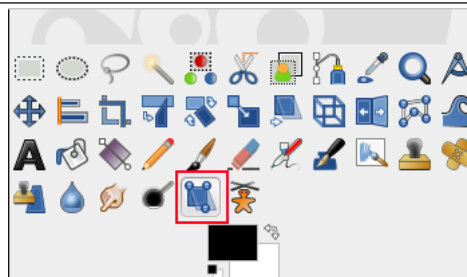
Lock: locks pivot.

14.4.10.3 Key modifiers

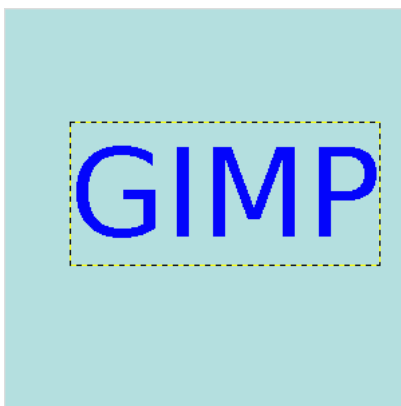
Key modifiers are active when an action (move, scale, rotate...) is selected. Hold on:

- **Shift** to check all Constrain unchecked options and uncheck already checked ones if a transformation handle is selected, or, if the pivot is selected, to snap pivot to center or corner,
- **Ctrl** to check all "From pivot" unchecked options and uncheck already checked ones.

14.4.11 Handle Transform

Figure 14.151 Handle Transform tool

This tool allows you to apply moving, rotating, shearing, perspective and scaling corrections using handles placed on canvas.



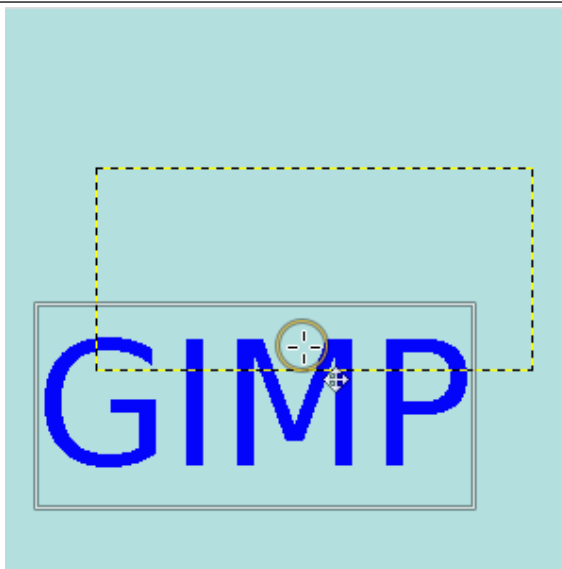
Original image: a text layer

You can use 1 to 4 handles, and the effect depends on the number of handles. The tool acts on a selection, or, if there is no selection, on the whole layer. The active handle is bigger than the others. When the mouse pointer is on a handle, it goes with a small icon that represents the active action.

When you click and drag a handle, a transformation is applied, and the other handles stay at their place:

- **With 1 handle:** click and drag the handle to *move* all pixels of the selection.

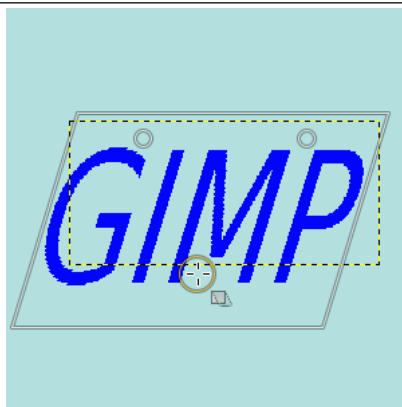
Figure 14.152 Example for 1 handle (Move)



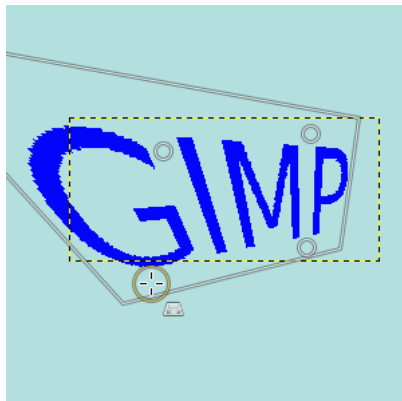
- **With 2 handles:** when you click and drag a handle, you *rotate* around the other handle as a center, and you *scale* the selection, keeping the aspect ratio.

Figure 14.153 Example for 2 handles (Rotate and scale)

- **With 3 handles:** when you click and drag a handle, you *shear* and *scale* the selection, aspect ratio is not kept.

Figure 14.154 Example for 3 handles (Shear and scale)

- **With 4 handles:** when you click and drag a handle, you *change perspective* and *scale* the selection, aspect ratio is not kept.

Figure 14.155 Example for 4 handles (Change perspective and scale)

14.4.11.1 Activating the Tool

There are different possibilities to activate the tool:

- From the image-menu: Tools → Transform Tools → Handle Transform



- The Tool can also be called by clicking the tool icon:
- or by clicking on the **ShiftCtrlH** keyboard shortcut.

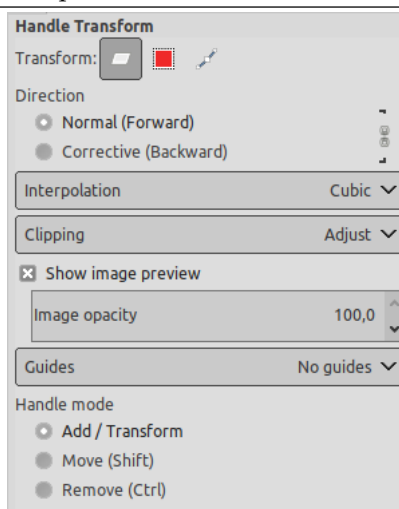
14.4.11.2 Key modifiers


Shift Press **Shift** and click on a handle to *move* it.

Ctrl Press **Ctrl** and click on a handle to *remove* it.

14.4.11.3 Options

Figure 14.156 Handle Transform Tool options



The available tool options can be accessed by double clicking the Handle Transform tool icon.  in toolbox.

Transform, Direction, Interpolation, Clipping, Show image preview, Guides

Note



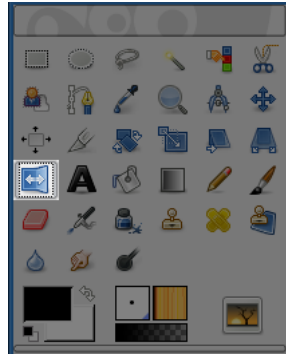
See Section 14.4.1 for a description of tool options that apply to many or all transformation tools.

Image opacity To set the opacity of the preview

Handle mode These options are describes in key modifiers section.

14.4.12 Flip


Figure 14.157 Flip tool



The Flip tool provides the ability to flip layers or selections either horizontally or vertically. When a selection is flipped, a new layer with a Floating Selection is created. You can use this tool to create reflections.

14.4.12.1 Activating the Tool

You can access the Flip Tool in different ways:

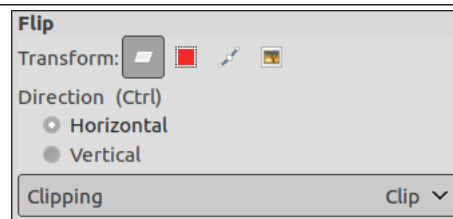
- From the image menu bar Tools/ Transform Tools Flip,
- By clicking the tool icon:  in Toolbox,
- by using the Shift-F key combination.

14.4.12.2 Key modifiers (Defaults)

Ctrl **Ctrl** lets you change the modes between horizontal and vertical flipping.

14.4.12.3 Options

Figure 14.158 “Flip Tool” Options



Normally, tool options are displayed in a window attached under the Toolbox as soon as you activate a tool. If they are not, you can access them from the image menu bar through Windows → Dockable Windows → Tool Options which opens the option window of the selected tool.

Affect

Note



These options are described in [Transform tools common options](#).

Flip Type The Tool Toggle settings control flipping in either a Horizontal or Vertical direction. This toggle can also be switched using **Ctrl**.

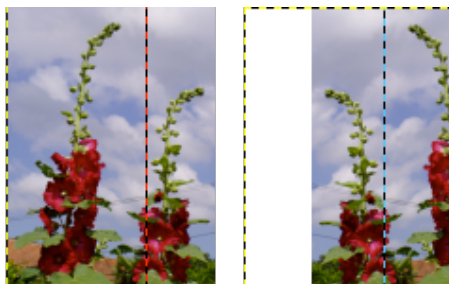
Clipping

Note



These options are described in [Transform tools common options](#).

Using Guides With GIMP-2.10, you can use guides as flipping axis, instead of the default layer center: place a guide, open Flip tool and click on the guide.



*On the left: original image with a guide activated.
On the right: result with Clipping option = Clip.*

14.4.13 The Cage Tool


Figure 14.159 The Cage Tool in the Toolbox



The Cage tool is a special transforming tool allowing you to select the transforming area by setting anchor points by free hand drawing similar to the way you do it with the Free Selection (Lasso) tool. The tool adds nothing to the image until you confirm the transformation by pressing the **Enter** key.

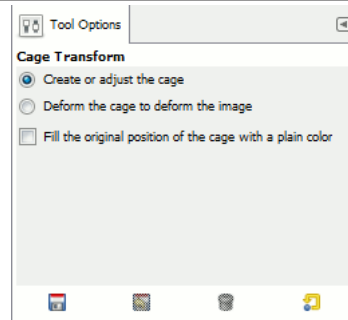
14.4.13.1 Activating the Tool

You can activate the Cage tool in several ways:

- From the image-menu, through: Tools → Transform Tools → Cage Transform
- by clicking on the tool icon:  in the toolbox
- or by using the **Shift G** keyboard shortcut.

14.4.13.2 Tool Options

Figure 14.160 Cage Tool options



Normally, tool options are displayed in a window attached under the Toolbox as soon as you activate a tool. If they are not, you can access them from the image menu bar through Windows → Dockable Windows → Tool Options which opens the option window of the selected tool.

Create or adjust the cage When activating the Cage Tool this option is selected. You can now click in the image to make anchor points around the desired area. If you need to add anchor points at a later stage, you click on this option.

Deform the cage to deform the image GIMP switch to this option automatically when the cage outline is finished. Now you are able to drag the anchor points around in the image and even outside it to transform the picture. The transforming starts when you release the mouse button.

You can activate more than one anchor point by holding down the **Shift** key while clicking on the points. You can also select more points by holding down the mouse button while drawing a rectangle around the desired points.

Fill the original position of the cage with a plain color If the transforming action results in empty areas these areas will be filled with color if this option is checked. It looks like the color is picked from the start pixel of the cage line.

14.4.13.3 Using “Cage” tool

Figure 14.161 Cage Tool example



When clicking on the cage icon in the toolbox the cage option is set to “Create or adjust the cage”. You are now able to draw a cage outline in the image by successively clicking around the area you want to

transform. Click on the starting point to finish the selection. GIMP will then do some mathematics and activate the “Deform the cage to deform the image” to allow you to drag the points on the line to deform the cage and the image.

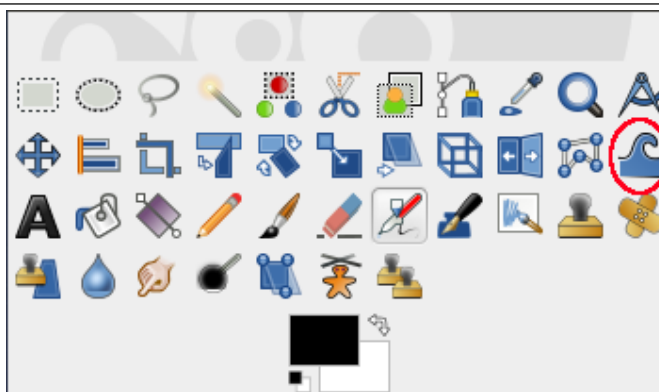
The selected point(s) turns to a square. Drag the points around in the image to transform it. The transforming will occur every time you release the press on the mouse button. The transforming may take some time so be patient especially when working with large images.

If you desire to add more points to the line you have to select the “Create or adjust the cage” in the tool options dialog. Put the points on the line and switch back to the “Deform the cage to deform the image” to transform the image or layer.

When the work is done, press the **Enter** key to confirm it.

14.4.14 Warp Transform

Figure 14.162 Warp Transform Tool



Warp Transform is a GEGL based brush-like tool which replaces the old iWarp filter and works directly on the image, on real things instead of a tiny preview window. You can use an erase mode to partially remove warping you applied. You have available options to adapt strength and size of warping.

14.4.14.1 Activating the Tool

There are different possibilities to activate the tool:

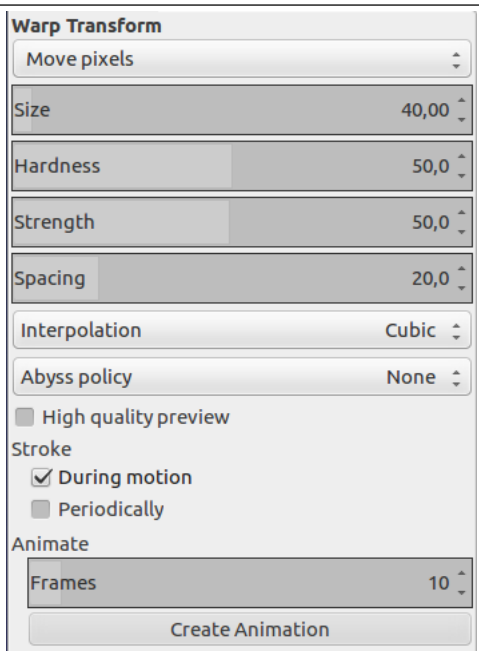
- from the image-menu: Tools → Transform → Warp Transform,

- by clicking the tool icon in toolbox: 

- or by clicking on the **W** keyboard shortcut.

14.4.14.2 Options

Figure 14.163 Warp Tool options




The available tool options can be accessed by double clicking the Warp Transform tool icon in toolbox.



Interpolation

Note

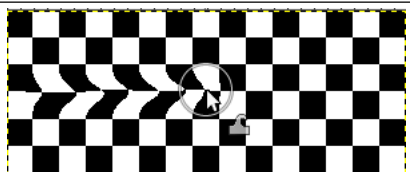


An interpolation method is used during warping. See [Interpolation](#) for a description of these methods.

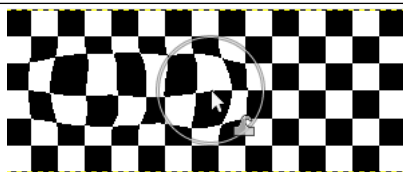
Move pixels “Move pixels” is the first item of a drop-down list which contains various warping methods:

- Move pixels is the default method.

Figure 14.164 Move pixels example



- Grow

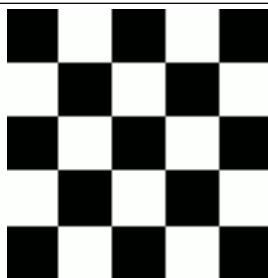
Figure 14.165 Grow example

- Shrink

Figure 14.166 Shrink example

Clicking 5 times at the center of the image with brush size = image size.

- Swirl clockwise/counter-clockwise

Figure 14.167 Swirl example

Swirling clockwise the whole image (brush size = image size) with a circular movement of the brush.

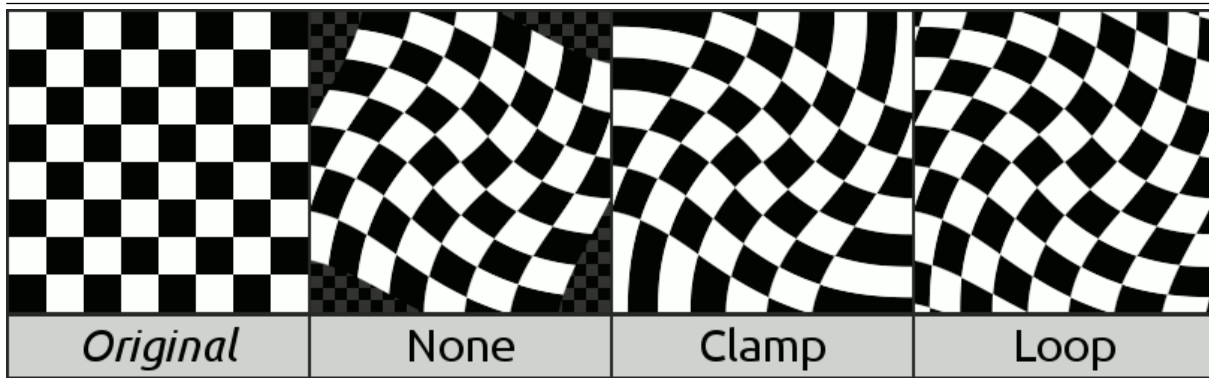
Adapting Size, Hardness, Strength, Spacing

- Size : the size of the brush is increased.
- Hardness : TODO (work in progress).
- Strength: set displacement of pixels during warping. The maximum of displacement is on the brush diameter.
- Spacing : TODO (work in progress)

Abyss policy “Abyss” is a term used by GIMP developers for “data outside the input buffer”. The warp tool moves pixels from one point to another. Some pixels may come from outside the layer boundary. These pixels don’t actually exist anywhere, and therefore don’t have any associated color; yet, *some* color must be assigned to them.

“Abyss policy” has a drop-down list that allows you to fill empty areas in different manners:

- None: this is the default option. Empty areas are transparent. An alpha layer is necessary for this option.
- Clamp: each edge of the transformed layer stretches out indefinitely, so, for example, a pixel to the left of the layer boundary has the same color as the leftmost pixel of the layer with the same y coordinate. An alternative way to think of it is that each pixel outside the layer boundary has the same color as the closest pixel inside the layer boundary.
- Loop: the transformed layer repeats itself in all directions, so that, for example, falling off the right edge of the layer takes you back to the left edge.
- Black, White>: these options are similar to “none”, but use black and white for out-of-bounds pixels, instead of transparency.

Figure 14.168 Examples for Abyss policy options

High quality preview “preview” is the image window, where you work, before pressing **Enter** to validate the transformation. With this option checked, preview is more accurate, but slower.

Stroke TODO (work in progress)

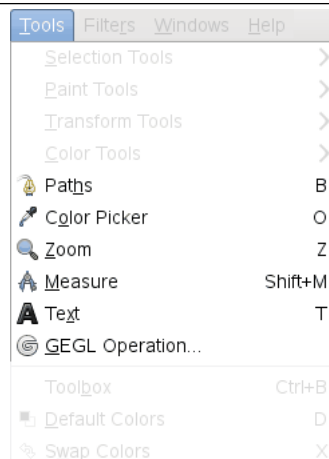
Animate This option allows you to generate several intermediate images between the original image and the final deformation of this image.

Frames to set the number of frames in this animation.

Create Animation button: to create the animation. A new image window is created. Export it as a GIF image, checking the As animation option in the export dialog.

14.5 Other

14.5.1 Overview

Figure 14.169 Other Tools in the Tools Menu

“Other” tools are simply those tools which don’t belong to any main group of tools. You will find here, for example, the important and powerful **Path** tool as well as useful helper tools like the **Color Picker**:

- Section [14.5.2](#)
- Section [14.5.3](#)
- Section [14.5.4](#)
- Section [14.5.5](#)
- Section [14.5.6](#)
- Section [14.5.7](#)

14.5.2 Paths

Figure 14.170 Paths tool



The Paths tool allows to create complex selections called Bézier Curves, a bit like Lasso but with all the adaptability of vectorial curves. You can edit your curve, you can paint with your curve, or even save, import, and export the curve. You can also use paths to create geometrical figures. Paths have their own dialog box: [Dialog](#).

14.5.2.1 Activating the Tool

You can get this tool in several ways:

- In the image menu through Tools → Paths,

- By clicking the tool icon:  in Toolbox,

- or by using the **B** keyboard shortcut.

14.5.2.2 Key modifiers (Defaults)

Note



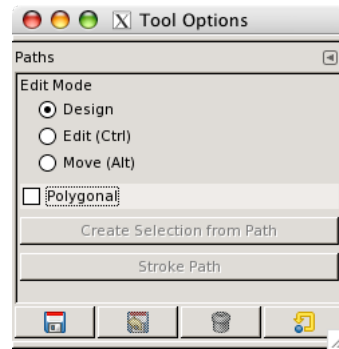
Help messages pop up at the bottom of the image window to help you about all these keys.

Shift This key has several functions depending on context. See Options for more details.

Ctrl ; Alt Three modes are available to work with the Paths tool: Design, Edit and Move. **Ctrl** key toggles between Design and Edit. **Alt** (or Ctrl-Alt) key toggles between Design and Move.

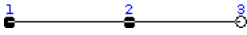
14.5.2.3 Options

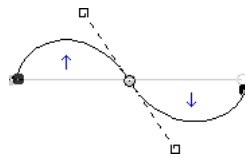
Figure 14.171 "Path" tool options



Normally, tool options are displayed in a window attached under the Toolbox as soon as you activate a tool. If they are not, you can access them from the image menu bar through Windows → Dockable Windows → Tool Options which opens the option window of the selected tool.

Design Mode By default, this tool is in Design mode. You draw the path by clicking successively. You can move control points by clicking on them and dragging them. Between control points are segments.

 Numbers are steps to draw a two segments straight path.




Curved segments are easily built by dragging a segment or a new node. Blue arrows indicate curve. Two little handles appear that you can drag to bend the curve.

Tip



To quickly close the curve, press **Ctrl** key and click on the initial control point. In previous versions, clicking inside a closed path converted it into Selection.

Now, you can use the Create selection from path button or  the *Path to Selection* button in the Path Dialog.

Tip



When you have two handles, they work symmetrically by default. Release the pressure on the mouse button to move handles individually. The **Shift** key will force the handles to be symmetrical again.

Several functions are available with this mode:

Inserting a new node: When you press **Ctrl** and hover the mouse pointer over the existing path, the mouse pointer changes to the '+' sign. Clicking will create a new path node in the hovered point of the path.

Moving one or several nodes: On a node, the mouse pointer becomes a 4-arrows cross. You can click and drag it. You can select several nodes by **Shift** and click and move them by click and drag. Pressing **Ctrl-Alt** allows to move all the path, as a selection.

Modifying handles: You have to Edit a node before. A handle appears. Drag it to bend the curve. Pressing **Shift** toggles to symmetric handles.

Modify segment: When the mouse pointer goes over a segment, it turns to a 4-arrows cross. Click and drag it to bend the segment. As soon as you move it, handles appear at both ends of the segment. Pressing the **Shift** key toggles to symmetric handles.

Adding a new subpath: When you press **Shift** and hover the mouse pointer outside the existing path, the mouse pointer starts displaying a square. Clicking will start a subpath that isn't connected to other curves, but is considered a part of the path.

Edit Mode Edit performs functions which are not available in Design mode. With this mode, you can work only on the existing path. Outside, the pointer is a small crossed circle (on the whole image if there is no path!) and you can do nothing.

Add a segment between two nodes: Click on a node at one end of the path to activate it. The pointer is like a union symbol. Click on an other node to link both nodes. This is useful when you have to link unclosed components.

Remove a segment from a path: While pressing Shift-Ctrl key combination, point to a segment. Pointer turns to -. Click to delete the segment.

Add a node to a path: point to a segment. Pointer turns to +. Click where you want to place the new control point.

Remove a node: While pressing Shift-Ctrl key combination, point to a node. Pointer turns to -. Click to delete the node.

Add a handle to a node: Point to a node. Pointer turns to small hand. Drag the node: handle appears. Pressing **Shift** toggles to symmetric handles.

Remove a handle from a node: While pressing Shift-Ctrl key combination, point to a handle. The pointer doesn't turn to the expected - and remains a hand. Click to delete the handle.

Caution



No warning before removing a node, a segment or a handle.

Move Mode Move mode allows to move one or all components of a path. Simply click on the path and drag it.

If you have several components, only the selected one is moved. If you click and drag outside the path, all components are moved. Pressing **Shift** key toggles to move all components also.

Polygonal With this option, segments are linear only. Handles are not available and segments are not bent when moving them.

Create selection from path This button allows creation of a selection that is based on the path in its present state. This selection is marked with the usual "marching ants". Note that the path is still present: current tool is still path tool and you can modify this path without modifying the selection that has become independent. If you change tool, the path becomes invisible, but it persists in Path Dialog and you can re-activate it.

If the path is not closed, GIMP will close it with a straight line.

As the help pop-up tells, pressing **Shift** when clicking on the button will add the new selection to an eventually pre-existent. Pressing the **Ctrl** will subtract the selection from the pre-existent and the Shift-Ctrl key combination will intersect the two selections.

Stroke path In previous versions, you could access to this command only by the Edit sub-menu in the Image Menu. Now you can access to it also via this button. See Section 16.3.21 and Section 7.5.

See the [Path](#) concept.

14.5.3 Color Picker


Figure 14.172 The Color Picker in the toolbox (eye dropper icon)



The Color Picker Tool is used to select a color on any image opened on your screen. By clicking a point on an image, you can change the active color to that which is located under the pointer. By default, the tool works on the active layer, but the Sample Merge option lets you grab the color as it is in the image, resulting of the combination of all layers. *Only colors in visible layers are used.* An Info window opens when you click on the image.

14.5.3.1 Activating the Tool

You can get to this tool in several ways :

- In the image menu through Tools → Color Picker.,
- by clicking the tool icon  in Toolbox,
- by pressing the **O** keyboard shortcut,
- by pressing the **Ctrl** key while using a paint tool. The Color-picker dialog is not opened during this operation and the tool remains unchanged after releasing the key. Nevertheless, you can get information by using the **Pointer window**.

14.5.3.2 Key modifiers

Ctrl **Ctrl** does nothing here. But, when using a paint tool, pressing **Ctrl** allows you to pick colors without having to switch to *Color Picker* tool.

Shift If the Use info window option is not checked, pressing **Shift** key, opens the Color Picker Information window when you click on a pixel.

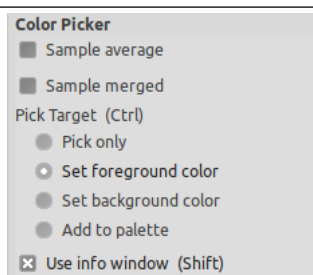
Note



The **Pointer Information** gives you the same information permanently. But be warned, it defaults to Sample merged.

14.5.3.3 Options

Figure 14.173 Color Picker Options



Normally, tool options are displayed in a window attached under the Toolbox as soon as you activate a tool. If they are not, you can access them from the image menu bar through Windows → Dockable Windows → Tool Options which opens the option window of the selected tool.

Sample Merged When enabled, the Sample Merged checkbox will take color information as a composite from all the visible layers. Further information regarding Sample Merge is available in the glossary entry, [Sample Merge](#).

Sample Average The Radius slider adjusts the size of the square area that is used to determine an average color for the final selection. When you keep clicking the layer, the mouse pointer shows the size of the square or radius.

Pick Target (Ctrl)

Pick Only The color of the selected pixel will be shown in an Information Dialog, but not otherwise used.

Set Foreground Color The Foreground color, as shown in the Toolbox Color Area, will be set to the color of the pixel you click on.

Set Background Color The Background color, as shown in the Toolbox Color Area, will be set to the color of the pixel you click on.

Add to Palette When this option box is checked, the picked color is sent to the active color palette. See [Palette Editor](#).

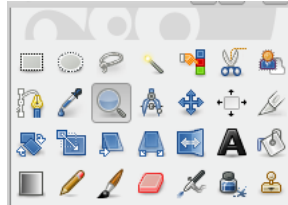
Use info window When this option is checked, the information window is opened automatically. The **Shift** key allows you to toggle this possibility temporarily.

Figure 14.174 Color Picker Info Window




14.5.4 Zoom

Figure 14.175 The “Zoom” tool in Toolbox



The Zoom Tool is used to change the zoom level of your working image. If you only click on the image, the zoom is applied to the whole image. But you can also click-and-drag the mouse pointer to create a zoom rectangle. Then, the action of this rectangle is better understood if the “Allow window resizing” option is unchecked: you can see that the content of this rectangle will be enlarged or reduced so that its biggest dimension fit the corresponding dimension of the image window (if the biggest dimension of the rectangle is width, then it will fit the width of the image window).

14.5.4.1 Activating the Tool

- You can get to the Zoom Tool from the image-menu through : Tools → Zoom,
- or by clicking the tool icon:  in Toolbox.

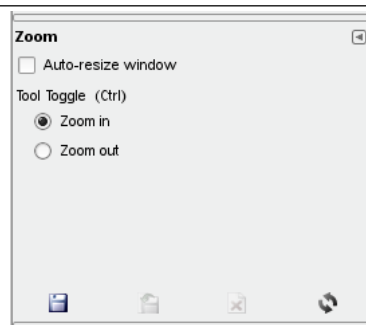
14.5.4.2 Key modifiers (Defaults)

Ctrl Holding **Ctrl** when clicking on a point of your image will change the zoom direction from zooming in to zooming out.

Ctrl-Mouse wheel Spinning the mouse wheel, while pressing **Ctrl**, varies the zoom level.

14.5.4.3 Options

Figure 14.176 Zoom tool options



Auto-resize window This option will allow the canvas to be resized if the zoom level dictates it.

Tool Toggle The two available tool toggles are used for changing the zoom direction between zooming in and zooming out.

14.5.4.4 Zoom menu

Using the Zoom tool is not the only way to zoom an image. The **Zoom menu** provides access to several functions for changing the image magnification level. For example, you can easily choose an exact magnification level from this menu.

14.5.5 Measure

Figure 14.177 Measure tool



The Measure Tool is used to gain knowledge about pixel distances in your working image. By clicking and dragging the mouse button, you can determine the angle and number of pixels between the point of click and where the mouse pointer is located. The information is displayed on the status bar or can also be displayed in the Info Window.

A common use case for “Measure” is to calculate the angle of rotation when horizon is uneven on a photo. Since GIMP-2.10.4, you no longer have to perform the rotation manually to straighten horizon: after measuring the angle, just click the new *Straighten* button.

This button can be used in straightening horizontal or vertical lines up: the starting point comes with a small bar that shows the direction.


When you pass the mouse pointer over the end point it turns to a move pointer. Then if you click you can resume the measure.

14.5.5.1 Status Bar

Information is displayed in the **status bar**, at the bottom of the Image window:

- Distance between the original point and the mouse pointer, in pixels.
- Angle, in every quadrant, from 0° to 90°.
- Pointer coordinates relative to the original point.

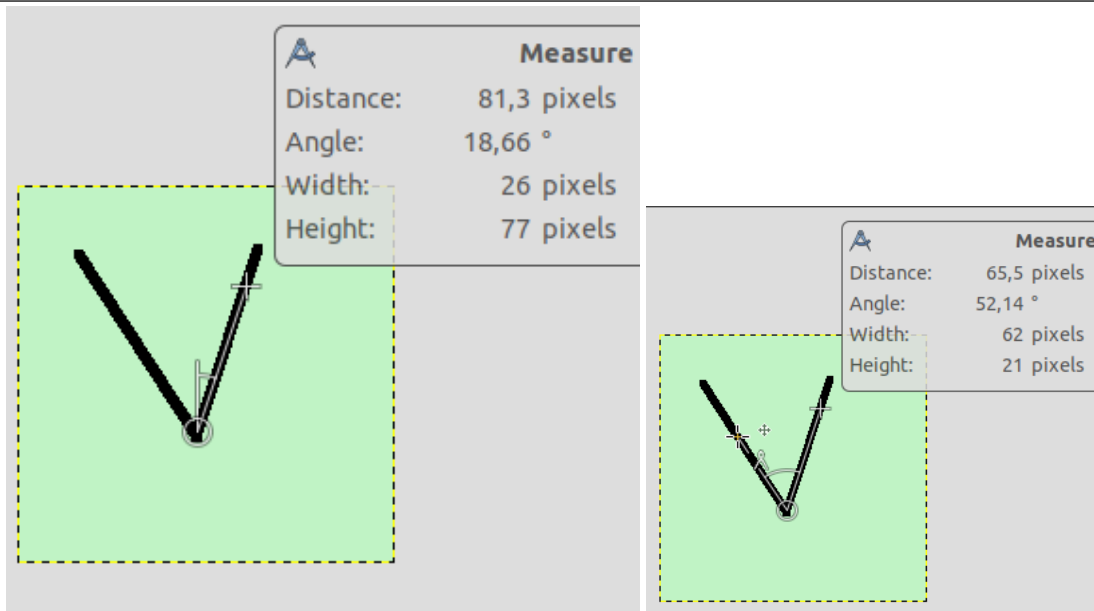
14.5.5.2 Activating the Tool

- You can get to the “Measure” from the image-menu through: Tools → Measure,
- or by clicking the tool icon:  in Toolbox.

14.5.5.3 Key modifiers (Defaults)

Shift While holding down the Shift key, click and drag from an existing endpoint to create a second measurement line from this endpoint. The angle between the two lines will be displayed. Any endpoint can be moved by clicking and dragging. So, you can *measure any angle* on the image:


Figure 14.178 Shift modifier



(a) Click on start point and drag following a side of the angle.

(b) Then, Shift-click on start point and drag following the other side of the angle: you get the value of this particular angle.

Ctrl Holding down the **Ctrl** key puts the tool into constrained straight line mode. The orientation of the line is constrained to the nearest multiple of 15 degrees.

Ctrl key pressed and click on an end point creates a horizontal guide. The mouse pointer goes with the  icon.

In Horizontal or Vertical Orientation modes, **Ctrl** also toggles between Horizontal and Vertical.

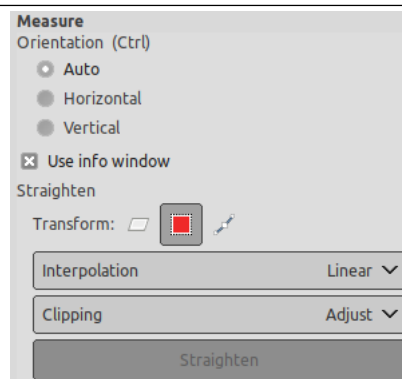
Alt **Alt** key and click on an end point creates a vertical guide.

Ctrl-Alt This key combination and click on a measure line allows to move the measure.

Ctrl-Alt key combination and click on an end point creates a vertical and a horizontal guides.

14.5.5.4 Options

Figure 14.179 “Measure” tool options



Orientation (Ctrl) In the Auto mode (default), Straighten will snap to the smallest angle between the measure line and the vertical or horizontal direction. Horizontal and Vertical allow to override this behavior by specifying explicitly what it should be.

Use Info Window This option will display an Info Window dialog that details the measure tool results. The results are more complete than on the status bar.

Straighten Transform, Interpolation, and Clipping are treated in Section 14.3.1. Here is an example for straightening a path:

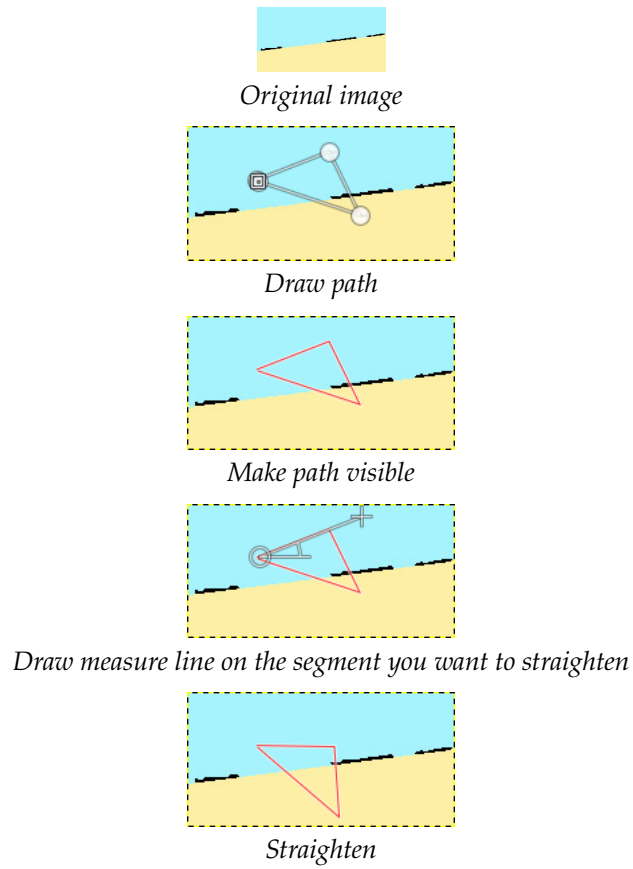
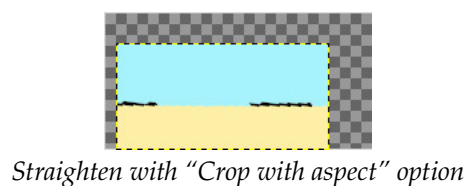
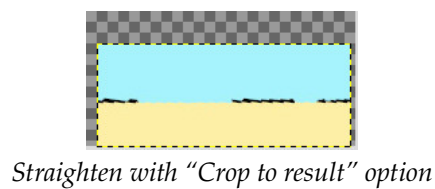
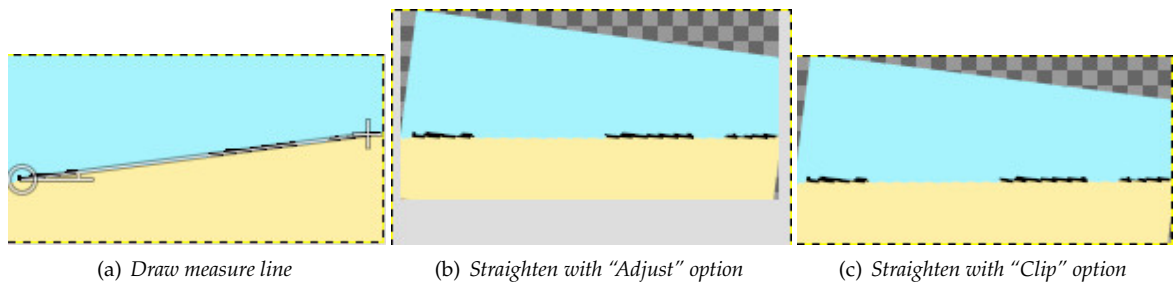


Figure 14.180 “Straighten” clipping options



Straighten: click on this button to perform straightening.

14.5.5.5 Measuring surfaces

You can't measure surfaces directly, but you can use the **Histogram** that gives you the number of pixels in a selection.

14.5.6 Text

Figure 14.181 The Text tool in Toolbox



The Text tool places text into an image. With GIMP-2.8, you can write your text directly on the canvas. No Text Editor is needed anymore (although you can still use it if you want by checking the Use editor option in the Tool Options dialog). A text toolbar has been added which allows you to edit text in different ways but you can still go on using the *Text Option dialog*, to change the font, color and size of your text, and justify it, interactively. Right clicking on the frame opens a context menu that allows you to copy, cut, paste, load a text...

As soon as you type your text, it appears on the canvas in a rectangular frame. If you draw the rectangular frame first, the text is automatically adapted to the frame size. You can enlarge this frame as you do with rectangular selections.



In this chapter, tool options will be described. To know how to use the Text tool, please refer to [text management](#).

14.5.6.1 Activating the Tool

You can access this tool in several ways:

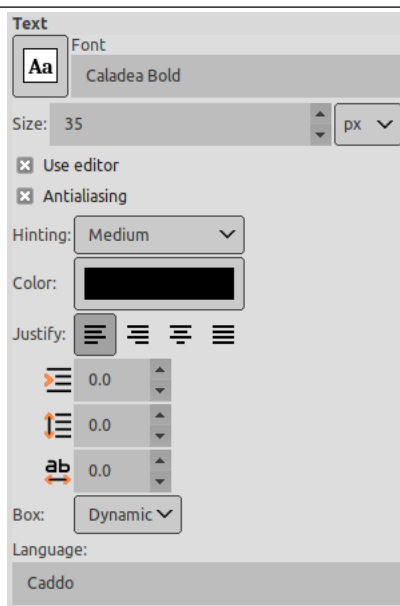
- In the image menu through Tools → Text,

- by clicking the tool icon  in Toolbox,

- or by using the **T** keyboard shortcut.

14.5.6.2 Options

Figure 14.182 Text tool options



Normally, tool options are displayed in a window attached under the Toolbox as soon as you activate a tool. If they are not, you can access them from the image menu bar through Windows → Dockable Windows → Tool Options which opens the option window of the selected tool.

Font Click on the fonts button **Aa** to open the font selector of this tool, which offers you a list of installed X fonts.

At the bottom of the font selector you find some icons which act as buttons for:

- resizing the font previews,
- selecting *list view* or *grid view*,
- opening the **font dialog**.

Choose a font from the installed fonts. When you select a font it is interactively applied to your text.

Tip



You can use the scroll wheel of your pointing device (usually your mouse) on the fonts button in order to quickly change the font of your text (move the pointer on the fonts button, and don't click, just use the wheel button).

Size This control sets the size of the font in any of several selectable units.

Use editor Use an external editor window for text editing instead of direct-on-canvas editing.

Antialiasing Antialiasing will render the text with much smoother edges and curves. This is achieved by slight blurring and merging of the edges. This option can radically improve the visual appearance of the rendered typeface. Caution should be exercised when using antialiasing on images that are not in RGB color space.

Hinting Uses the index of adjustment of the font to modify characters in order to produce clear letters in small font sizes.

Color Color of the text that will be drawn next. Defaults to black. Selectable from the color picker dialog box that opens when the current color sample is clicked.

Tip

You can also click-and-drag the color from the Toolbox color area onto the text.

Justify Causes the text to be justified according to any of four rules selectable from the associated icons.

Indent Controls the indent spacing from the left margin, for the first line.

Adjust line spacing Controls the spacing between successive lines of text. This setting is interactive: it appears at the same time in image text. The number is not the space between lines itself, but how many pixels must be added to or subtracted from this space (the value can be negative).

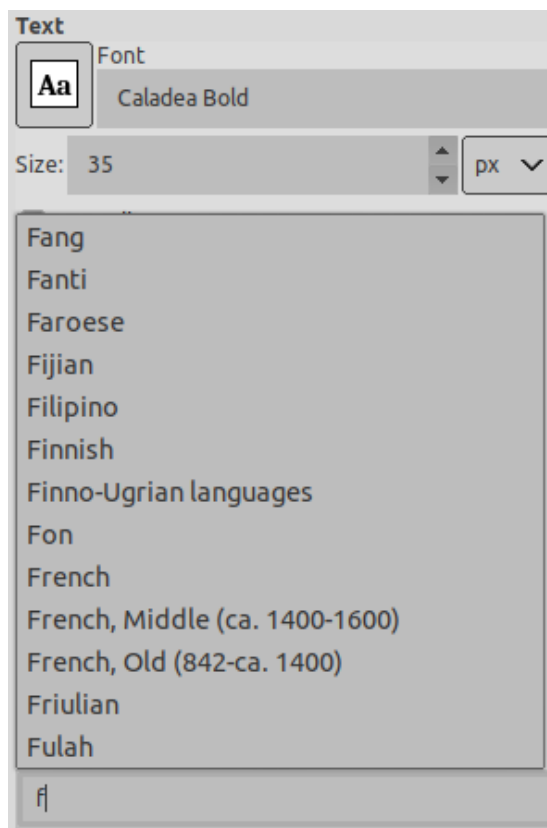
Adjust letter spacing Controls the spacing between letters. Also in this case the number is not the space itself between letters, but how many pixels must be added to or subtracted from this space (the value can be negative).

Box Concerns the text box. The associated drop down list offers two options:

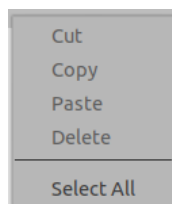
Dynamic: default option. The size of the text box increases as you type. Text may go out of the image. You have to press the **Enter** key to add a new line. The indent option indents all lines. If you increase the box size, the option turns to "Fixed".

Fixed: you must enlarge the text box first. Else, usual shortcuts are active! The text is limited by the right side of the box and continues on next line. This is not true new line: you must press the **Enter** key to add a real new line. The text may go out the lower border of the image. The indent option works on the first line only.

Language The text language may have an effect on the way the text is rendered. The default language is "Caddo", the language of several Southeastern Native American tribes. If you enter a letter in this field, you get the list of all available languages whose names begin by this letter:

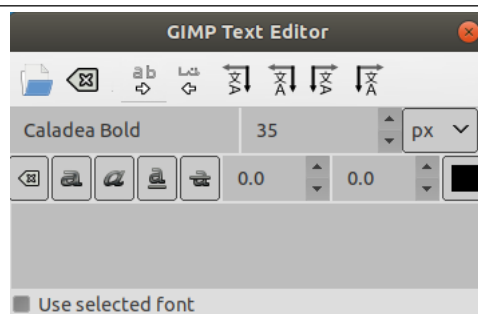


Right clicking on this field opens a menu that allows you to manage languages:



14.5.6.3 Text Editor

Figure 14.183 The Text Editor



Since GIMP-2.8, you can edit text directly on canvas and this text editor is available only if the Use editor option is checked.

As soon as you start writing, a Text layer is created in the Layer Dialog. On an image with such a layer (the image you are working on, or a `.xcf` image), you can resume text editing by activating this text layer then clicking on it (double click). Of course, you can apply to this text layer the same functions you use with other layers.

To add another text to your image click on a non-text layer: a new Text Editor will appear and a new text layer will be created. To pass from a text to another one activate the corresponding text layer and click on it to activate the editor.

The Text Editor options

All these options are also in the text context menu.

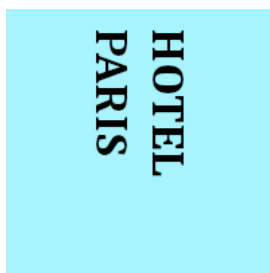
With GIMP-2.10.6, vertical text (top-to-bottom writing) became possible. This feature is particularly for East-Asian writing systems, but also for anyone wishing to design fancy vertical text.

Load Text from file Text can be loaded from a text file by clicking the folder icon in the text editor. All the text in the file is loaded.

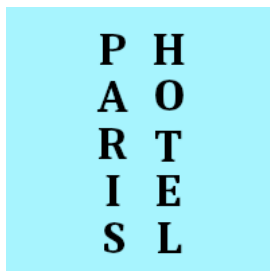
From left to right This option causes text to be entered from left to right, as is the case with most Western languages and many Eastern languages.

From right to left This option allows text to be entered from right to left, as is the case with some Eastern languages, such as Arabic (illustrated in the icon).

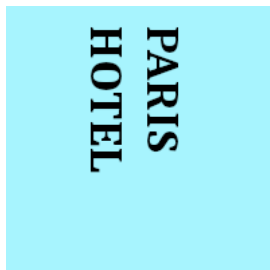
Vertical, right to left (mixed orientation) Text is written top-to-bottom in columns, from right to left, and is rotated 90° clockwise.



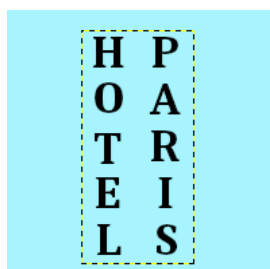
Vertical, right to left (upright orientation) Text is written top-to-bottom in columns, from right to left, upright.



Vertical, left to right (mixed orientation) Text is written top-to-bottom in columns, from left to right, and is rotated 90° clockwise.



Vertical, left to right (upright orientation) Text is written top-to-bottom in columns, from left to right, upright.



Use selected font Default doesn't use the font you have selected in the Options dialog. If you want to use it, check this option.

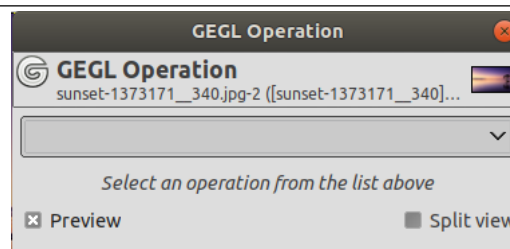
Note



See also Section [9.2](#)

14.5.7 GEGL Operation

Figure 14.184 GEGL Operation tool



GEGL (“Generic Graphical Library”) is a graph based image processing library designed to handle various image processing tasks needed in GIMP.

The GEGL Operation tool has been added in [GIMP 2.6](#) and was originally meant as an useful experimental tool for GIMP developers. The GEGL Operation tool enables applying GEGL operations to the image and gives on-canvas previews of the results.

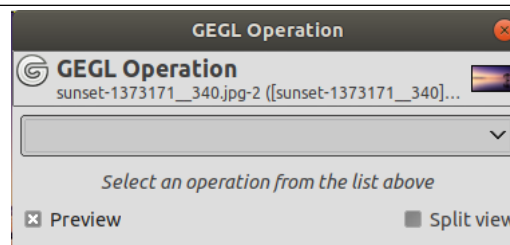
GIMP-2.10 is nearly fully ported to GEGL. You will find here some operations that still are experimental.

14.5.7.1 Activating the Tool

You can get to this tool only from the image menu: Tools → GEGL Operation.

14.5.7.2 Options

Figure 14.185 GEGL Operation tool options



GEGL Operation tool with no operation selected.

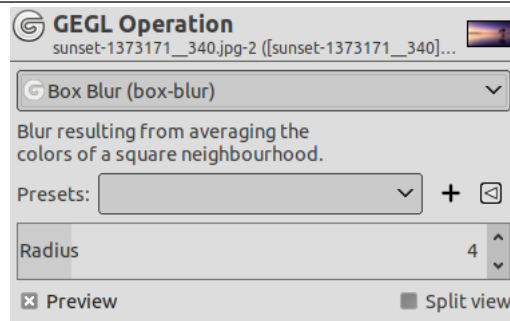
Operation Click on this button to select the operation you want to apply to the active selection or, if there is no selection, to the active layer.

Some of these operations are very basic operations like “color” which fills the active selection or layer with the specified color, while operations like “fractal-explorer” produce fairly complex patterns — just like a [rendering filter](#).

Remember that this is an experimental tool, so some operations may not work or even crash GIMP. As a consequence, it doesn't make sense to describe the operations here as long as the GEGL Operation tool is experimental

Operation Settings The operation settings depend on the selected Operation:

Figure 14.186 "Operation Settings" example



GEGL operation "Gaussian Blur" selected.

If the options of the selected GEGL operation are not self-explanatory (guess what's the purpose of the "color" operation's "Color" option) you can look for a corresponding non-GEGL tool. For example, the **Fractal Explorer** filter may have the same or similar options as the "fractal-explorer" operation.

Or you can make use of the nice realtime preview feature and just experiment with different settings.

Preview If this options is checked, as it is by default, you will get an on-canvas preview of the selected operation as soon as the operation in finished. You will have to press the OK button to actually apply the operation to the image.

The tool buttons

Reset Pressing this button resets the operation settings the to their defaults.

Cancel Clicking on this button aborts the GEGL operation tool and leaves your image untouched. This is equivalent to close the dialog window using the usual Close button provided by your window manager.

OK You have to press this button to apply the selected operation to the image. Then the dialog window will be closed.

Chapter 15

Dialogs

15.1 Dialog Introduction

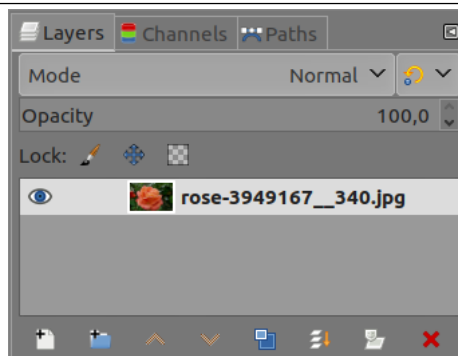
Dialogs are the most common means of setting options and controls in the GIMP. The most important dialogs are explained in this section.

15.2 Image Structure Related Dialogs

The following dialogs let you control and manipulate image structures, such as **layers**, **channels**, or **paths**.

15.2.1 Layers Dialog


Figure 15.1 Layers Dialog



The “Layers” dialog is the main interface to edit, modify and manage your layers.

15.2.1.1 Activating the dialog

The “Layers” dialog is a dockable dialog; see the section Section 3.2.3 for help on manipulating it. You can access it:

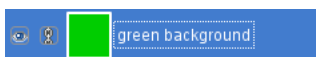
- from the image menu: Windows → Dockable Dialogs → Layers;
- from the Tab menu in any dockable dialog by clicking on  and selecting Add Tab → Layers,
- from the (default) shortcut: Ctrl-L.

In the Windows menu, there is a list of **detached windows** which exists only if at least one dialog remains open. In this case, you can raise the “Layers” dialog from the image-menu: Windows → Layers.

15.2.1.2 Using the Layer dialog

Overview Every layer appears in the dialog in the form of a thumbnail. When an image has multiple layers as components, they appear as a list. The upper layer in the list is the first one visible, and the lowest layer the last visible, the background. Above the list one can find characteristics related individually to each layer. Under the list one can find management buttons for the layer list. A right-click in a layer thumbnail opens the Layer **context menu**.

Layer attributes Every layer is shown in the list along with its attributes:



Layer visibility In front of the thumbnail is an icon showing an eye. By clicking on the eye, you toggle whether the layer is visible or not. (**Shift**-clicking on the eye causes all *other* to be hidden.)



Chain layers Another icon, showing a chain, allows you to group layers for operations on more than one layer at a time (for example with the Move tool).

Layer thumbnail The layer content is represented in a thumbnail. Maintaining left-click for a second on this thumbnail makes it larger. When the layer is active, the thumbnail has a white border. The border is black if the layer is inactive. When the layer has a mask, the inactive element takes a black border.

Layer name The main attribute is the name of the layer. You can edit this by a double-click on the name of the layer. You can also use the “Edit Layer Attributes” dialog you can find in the context menu that you get by through a right-click on the layer.

Note



In the case of an animation layer (GIF or MNG), the name of the layer can be used to specify certain parameters : Layer_name (delay in ms) (combination mode), for example Frame-1 (100 ms) (replace). The delay sets the time during which the layer is visible in the animation. The combination mode sets whether you combine the layer with the previous layer or replace it: the two modes are (combine) or (replace).

Layers characteristics Above the layer list, it is possible to specify some properties for the active layer. The active layer is the one highlighted in blue. The properties are: “Layer mode”, “Opacity”, “Lock pixels” and “Lock Alpha channel”.

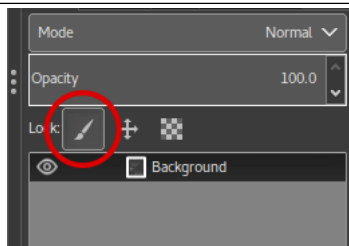
Mode The layer mode determines how the layer interacts with the other layers. From the combo box you can access all the modes provided by GIMP. The layer modes are fully detailed in Section 8.2.

Opacity By moving the slider you give more or less opacity to the layer. With a 0 opacity value, the layer is transparent and completely invisible. Don’t confuse this with a Layer Mask, which sets the transparency pixel by pixel.

Lock You have three possibilities:

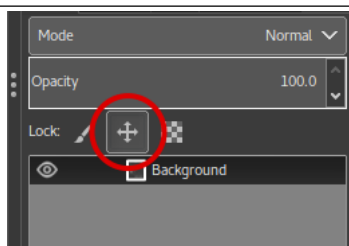
- **Lock pixels:** When the button is pressed down, you cannot use any brush-based tool (Paintbrush, Pencil, Eraser etc.), the Airbrush or the Ink tool on the currently selected layer. This may be necessary to protect them from unwanted changes.

Figure 15.2 Lock pixels



- **Lock position and size:** This toggle button enables and disables protection of layers from moving them around or transforming them. When the button is pressed down, you cannot use any transform tool (Rotate, Shear, Perspective and others) or move it.

Figure 15.3 Lock position and size



- **Lock alpha channel:** This toggle button controls the “Lock” setting for the transparency of the layer. If this is pressed down, then the alpha channel for the layer is locked, and no manipulation has any effect on it. In particular, nothing that you do to a transparent part of the layer will have any effect.

Figure 15.4 Lock Alpha channel

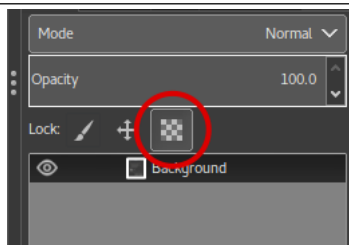
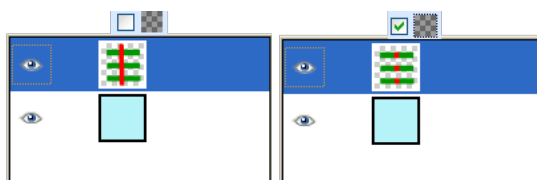


Figure 15.5 Example for Locking Alpha Channel



(a) The active layer has three horizontal, opaque, green opaque areas of the active layer stripes on a transparent back- are painted with red. Transparent areas are preserved. We paint a vertical red stripe. “Lock” unchecked: Opaque and transparent areas of the active layer are painted with red.

Tip



If a layer name in the Layer Dialog is in bold, then this layer has no Alpha channel.

Layer management Under the layer list a set of buttons allows you to perform some basic operations on the layer list.

New Layer Here you can create a new layer. A dialog is opened, which is described in [New Layer](#).

Press the **Shift** key to open a new layer with last used values.

New Layer Group Here you can create a new layer group. A new layer is created, where you can put layers down.

Layer groups are described in [Layer groups](#).

Raise layer Here you can move the layer up a level in the list. Press the **Shift** key to move the layer to the top of the list.

Lower layer Here you can move the layer down a level in the list. Press the **Shift** key to move the layer to the bottom of the list.

Tip



To move a layer at the bottom of the list, it may first be necessary to add a transparency channel (also called Alpha channel) to the Background layer. To do this, right click on the Background layer and select Add Alpha channel from the menu.

Duplicate layer Here you can create a copy of the active layer. Name of new layer is suffixed with a number.

Merge layers **Anchor layer** Before GIMP-2.10.18, this button was permanently for anchoring. Now, it becomes an anchor only when a floating selection is created (it anchors the floating selection to the previous active layer). Else, it is a Merge layers icon with several possibilities:

- Merge this layer with the first visible layer below it.
- Pressing **Shift**: merge the layer group's layers into one normal layer.
- Pressing **Ctrl**: merge all visible layers into one normal layer.
- Pressing **Shift-Ctrl**: merge all visible layers with last used values.

Delete layer Here you can delete the active layer.

More layer functions Other functions about *layer size* are available in the [Layer Drop down menu](#) you get by right clicking on the Layer Dialog. You can find them also in the Layer sub-menu of the image menu.

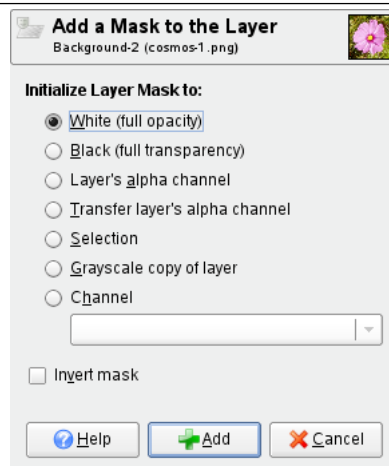
You will find *merging layers functions* in the [Image menu](#).

Clicking-and-dragging layers Click and hold on layer thumbnail: it enlarges and you can move it by dragging the mouse.

- So you can put this layer down *somewhere else in the layer list*.
- You can also *put the layer down into Toolbox*: a new image is created that contains this layer only.
- Finally, you can *put the layer down into another image*: this layer will be added to the layer list, above existing layers.

15.2.1.3 Layer masks

Figure 15.6 “Add mask” dialog



Overview A transparency mask can be added to each layer, it's called Layer mask. A layer mask has the same size and same number of pixels as the layer to which it is attached. Every pixel of the mask can then be coupled with a pixel at the same location in the layer. The mask is a set of pixels in gray-tone on a value scale from 0 to 255. The pixels with a value 0 are black and give a full transparency to the coupled pixel in the layer. The pixels with a value 255 are white and give a full opacity to the coupled pixel in the layer.

To create a layer mask start with a right click on the layer to call the context menu and select Add layer mask in the menu. A dialog appears where you can initialize the content of the mask:

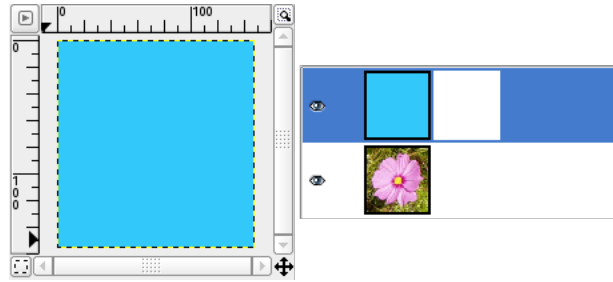
- **White (full opacity):** the mask is white in the Layer Dialog. So, all pixels of the layer are visible in the image window since painting the mask with white makes layer pixels fully visible. You will paint with black to make layer pixels transparent.
- **Black (full transparency):** the mask is black in the Layer Dialog. So, the layer is fully transparent since painting the mask with black makes layer pixels transparent. Painting with white will remove the mask and make layer pixels visible.
- **Layer's alpha channel:** the mask is initialized according to the content of layer Alpha channel. If the layer still contains transparency it's copied in the mask.
- **Transfer layer's alpha channel:** Does the same thing as the previous option, except that it also resets the layer's alpha channel to full opacity.
- **Selection :** the mask is initialized according to pixel values found in the selection.
- **Grayscale copy of layer:** the mask is initialized according to pixel values of the layer.
- **Channel:** The layer mask is initialized with a selection mask you have created before, stored in the Channel dialog.
- **Invert mask :** This checkbox allows you to invert : black turns to white and white turns to black.

When the mask is created it appears as a thumbnail right to the layer thumbnail. By clicking alternatively on the layer and mask thumbnail you can enable one or other. The active item has a white border (which is not well visible around a white mask). That's an important point. Always keep the Layers Dialog prominently when working with masks, because you can't see, looking at the canvas, which of the layer or the mask is active.

Pressing **Alt** (or **Ctrl-Alt** and click on the layer mask thumbnail) is equivalent to the **Show Layer Mask** command : the layer mask border turns to green. If you press **Ctrl** the border is red and the result is equivalent to the **Disable Layer Mask** command. To return to normal view redo last operation. These options are for greater convenience in your work.

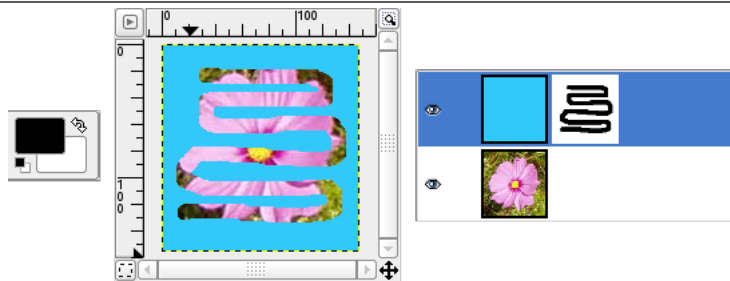
Layer Mask example

Figure 15.7 A layer with layer mask



This image has a background layer with a flower and another blue one, fully opaque. A white layer mask has been added to the blue layer. In the image window, the blue layer remains visible because a white mask makes layer pixels visible.

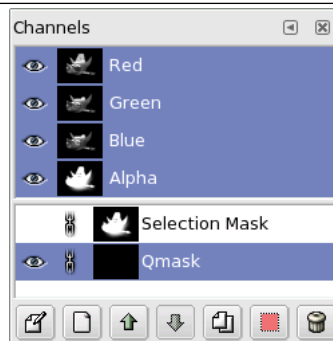
Figure 15.8 Painting the layer mask



The layer mask is active. You paint with black color, which makes the layer transparent: the underlying layer becomes visible.

15.2.2 Channels Dialog

Figure 15.9 The Channels dialog



The Channels dialog is the main interface to edit, modify and manage your channels. Channels have a double usage. This is why the dialog is divided into two parts: the first part for color channels and the second part for **selection masks**.

Color channels apply to the image and not to a specific layer. Basically, three primary colors are necessary to render all the wide range of natural colors. As other digital software, GIMP uses Red, Green, and Blue as primary colors. The first and primary channels display the Red, Green, and Blue values of each pixel in your image. Next to the channel name is a thumbnail displaying a grayscale representation of each channel, where white is 100% and black is 0% of the primary color. Alternatively, if your image is not a colored but a Grayscale image, there is only one primary channel called Gray. For an Indexed image with a fixed number of known colors there is also only one primary channel called Indexed. Then there is a optional channel called Alpha. This channel displays transparency values of each pixel in your

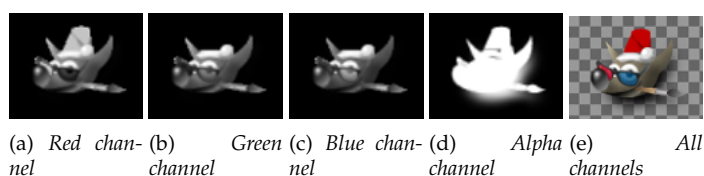
image (See [Alpha Channel](#) in Glossary). In front of this channel is a thumbnail displaying a grayscale representation of the transparency where white is opaque and visible, and black is transparent and invisible. If you create your image without transparency then the Alpha channel is not present, but you can add it from the [Layers dialog menu](#). Also, if you have more than one layer in your image, GIMP automatically creates an Alpha channel.

Note



GIMP doesn't support CMYK or YUV color models.

Figure 15.10 Representation of an image with channels




The right image is decomposed in three color channels (red, green, and blue) and the Alpha channel for transparency. On the right image the transparency is displayed as a gray checkerboard. In the color channel white is always white because all the colors are present and black is black. The red hat is visible in the red channel but quite invisible in the other channels. This is the same for plain green and blue which are visible only in their own channels and invisible in others.

15.2.2.1 Activating the Dialog

The “Channels” dialog is a dockable dialog; see Section [3.2.3](#) for help on manipulating it.

You can access it:

- from an image menu: Windows → Dockable Dialogs → Channels;
- from the Tab menu in any dockable dialog by clicking on  and selecting Add Tab → Channels.

In the Windows menu, there is a list of [detached windows](#) which exists only if at least one dialog remains open. In this case, you can raise the “Channels” dialog from the image-menu: Windows → Channels.

15.2.2.2 Using the Channel dialog

15.2.2.2.1 Overview

The top channels are the color channels and the optional Alpha channel. They are always organized in the same order and they cannot be erased. Selection masks are described below and displayed as a list in the dialog. Every channel appears in the list with its attributes, including a thumbnail and its name. A right-click in a channel list entry opens the [channel context menu](#).

15.2.2.2.2 Channel attributes

Every channel is shown in the list with its own attributes, which are very similar to the [layer attributes](#):



Channel visibility By default every channel and thus every color value is visible. This is indicated by an “open eye” icon. Clicking on the eye-symbol (or the space if the channel is not visible) will toggle the visibility of the channel.



Chain channels The channels representing selection masks (the new channels in the lower part of the channel list) may be grouped using the button with the “chain” symbol. Then these channels are all affected in the same way by operations applied to any one of them.

Primary color channels (the default channels in the upper part of the channel list) may be grouped too. By default, all color channels (and the alpha channel) are selected, their list entries are highlighted. Operations will be performed on all channels. By clicking on a channel list entry you can deactivate this channel. Operations like **colorizing** a layer will then be applied to the selected (“grouped”) channels only. Clicking again on the list entry will activate the channel.

Thumbnail A small preview-icon represents the effect of the channel. On a selection mask, this preview can be enlarged by holding click down on it.

Channel name The name of the channel, which must be unique within the image. Double-clicking on the name of a selection mask channel will allow you to edit it. The names of the primary channels (Red, Green, Blue, Alpha) can not be changed.

Caution



Activated channels appear highlighted (generally) in blue in the dialog. If you click on a channel in the list you toggle activation of the corresponding channel. Disabling a color channel red, blue, or green has severe consequences. For instance if you disable the blue channel, all pixels from now on added to the image will not have blue component, and so a white pixel will have the yellow complementary color.

15.2.2.3 Managing channels

Under the channel list is a set of buttons allowing you to perform some basic operations on channel list.



Edit Channel Attributes Only available for selection masks. Here you can change the Channel name. The other two parameters affect channel visibility in the image window; they control Opacity and color used for the mask in the image window. A click on the color button displays the GIMP color selector and then you can change the mask color.

New Channel You can create here a new channel. The displayed dialog lets you set Opacity and mask color used in the image to represent the selection. (If you use the New Channel button in Channel Menu, you can create this new channel with the options previously used by pressing the **Shift** key when clicking). This new channel is a channel mask (a selection mask) applied over the image. See **Selection Mask**

Raise Channel Only available for selection masks: you can here put the channel up a level in the list. Press **Shift** key to move channel to top of the list.


Lower Channel You can here put the channel down a level in the list. Press the **Shift** key to move the channel to bottom of the list.

Duplicate Channel You can create here a copy of the active channel. Name of new channel is suffixed with a number.

Tip



You can also duplicate a color channel or the Alpha channel. It's an easy way to keep a copy of them and to use them later as a selection in an image.

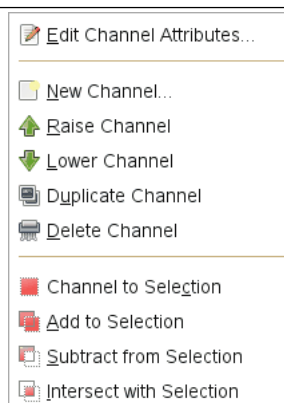
 **Channel to Selection** Here you can transform the channel to become a selection. By default the selection derived from a channel replaces any previous active selection. It's possible to change this by clicking on control keys.

- **Shift:** the selection derived from a channel is added to the previous active selection. The final selection is merged from both.
- **Ctrl:** the final selection is the subtraction of selection derived from a channel from the previously active one.
- **Shift-Ctrl:** the final selection is the intersection of selection derived from a channel with the previously active one. Only common parts are kept.

✗ Delete Channel Only available for selection masks: you can here delete the active channel.

15.2.2.2.4 Channels Context Menu

Figure 15.11 Channel Context Menu



Overview You can get the channel context menu by right clicking on a channel thumbnail. This menu gives the same operations on channels as those available from dialog buttons. The only difference concerns transformation to selection operations, each of them having its own entry in the menu.

Edit Channel Attributes, New Channel, Raise Channel, Lower Channel, Duplicate Channel, Delete Channel
See [Managing channels](#).

Channel to Selection Selection derived from channel replaces any previous active selection.

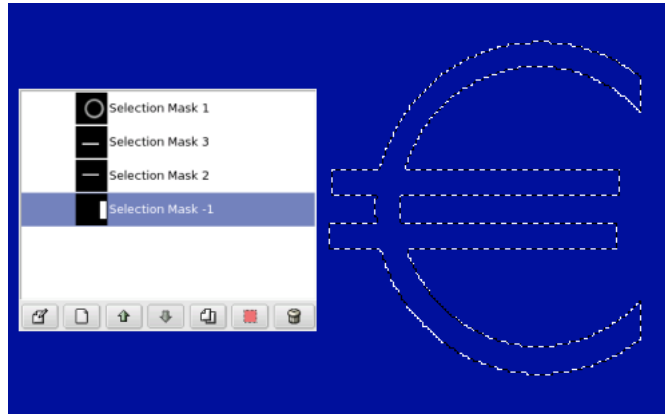
Add to Selection Selection derived from channel is added to previous active selection. Final selection is merging of both.

Subtract from Selection Final selection is subtraction of selection derived from a channel from previous active selection.

Intersect with Selection Final selection is intersection of selection derived from a channel with the previous active selection. Only common parts are kept.

15.2.2.3 Selection masks

Figure 15.12 A selection composed out of channels.




Channels can be used to save and restore your selections. In the channel dialog you can see a thumbnail representing the selection. Selection Masks are a graphical way to build selections into a gray level channel where white pixels are selected and black pixels are not selected. Therefore gray pixels are partially selected. You can think of them as feathering the selection, a smooth transition between selected and not selected. This is important to avoid the ugly pixelization effect when you fill the selection or when you erase its content after isolating a subject from background.

Creating Selection Masks There are several ways to initialize a selection mask.

- From the image window menu Select → Save to Channel if there is an active selection.
- In the image window the bottom-left button creates a **Quick Mask**; the content will be initialized with the active selection.
- From the channel dialog, when you click on the New channel button or from the context menu. When created, this Selection mask appears in the Channel dialog, named “Selection maskcopy” with a queuing number. You can change this by using the context menu that you get by right-clicking on the channel.

15.2.2.3.1 Using Selection Masks

Once the channel is initialized, selected (highlighted in blue), visible (eye-icon in the dialog), and displayed as you want (color and opacity attributes), you can start to work with all the paint tools. The colors used are important. If you paint with some color other than white, grey, or black, the color Value (luminosity) will be used to define a gray (medium, light, or dark). When your mask is painted, you can transform it to a selection by clicking on the  button (**Channel to Selection**) or from the **context menu**.

You can work in selection masks not only with the paint tool but also with other tools. For instance, you can use the selection tools to fill areas uniformly with gradients or patterns. By adding many selection masks in your list you can easily compose very complex selections. One can say that a selection mask is to a selection as a layer is to an image.

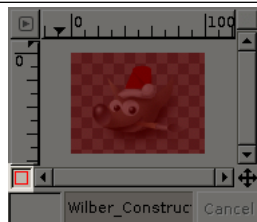
Caution



As long as a selection mask is activated you are working in the mask and not in the image. To work in the image you have to deactivate all selection masks. Don't forget also to stop displaying masks in the image by removing the eye icon. Check also that all RGB and Alpha channels are activated and displayed in the image.

15.2.2.4 Quick Mask

Figure 15.13 Dialog Quick Mask



A Quick Mask is a **Selection Mask** intended to be used temporarily to paint a selection. Temporarily means that, unlike a normal selection mask, it will be deleted from the channel list after its transformation to selection. The **selection tools** sometimes show their limits when they have to be used for doing complex drawing selection, as progressive. In this case, using the QuickMask is a good idea which can give very good results.

15.2.2.4.1 Activating the dialog

The QuickMask can be activated in different ways:

- From the image menu: Select → Toggle QuickMask.
- By clicking the left-bottom button showed in red on the screenshot.
- By using the Shift-Q shortcut.

15.2.2.4.2 Creating a Quick Mask

To initialize a Quick Mask, click the bottom-left button in the image window. If a selection was active in your image, then its content appears unchanged while the border is covered with a translucent red color. If no selection was active then all the image is covered with a translucent red color. Another click on the bottom-left button will deactivate the quick mask.

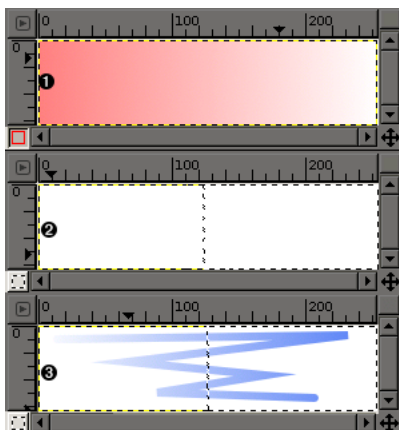
From the channel dialog you can double click on the name or the thumbnail to edit the QMask attributes. Then you can change the Opacity and its filling color. At every moment you can hide the mask

by clicking on the eye icon  in front of the QMask.

The mask is coded in gray tones, so you must use white or gray to decrease the area limited by the mask and black to increase it. The area painted in light or dark gray will be transition areas for the selection like feathering. When your mask is ready, click again on the bottom-left button in the image window and the quick mask will be removed from the channel list and converted to a selection.

Quick mask's purpose is to paint a selection and its transitions with the paint tools without worrying about managing selection masks. It's a good way to isolate a subject in a picture because once the selection is made you only have to remove its content (or inverse if the subject is in the selection).

15.2.2.4.3 Using Quick Mask with a gradient



Description

1. Screenshot of the image window with activated QuickMask. As long as the Quickmask is activated, all operations are done on it. A gradient from black (left) to white (right) has been applied to the mask.
2. The QuickMask is now disabled. The selection occupies the right half part of the image (marching ants) because the limit of the selection is at the middle of the gradient.
3. A stroke is now added during the enabled selection. Weird! The gradient, although not visible, remains active all over the image, in selected and non selected areas!

After the QuickMask Button is pressed, the command generates a temporary 8-bit (0-255) channel, on which the progressive selection work is stored. If a selection is already present the mask is initialized with the content of the selection. Once QuickMask has been activated, the image is covered by a red semi-transparent veil. This one represents the non-selected pixels. Any **paint tool** can be used to create the selection on the QuickMask. They should use only grayscale color, conforming the channel properties, white enabling to define the future selected place. The selection will be displayed as soon as the QuickMask will be toggled but its temporary channel will not be available anymore.

Tip



To save in a channel the selection done with the Quickmask select in the image menu Select/Save to Channel

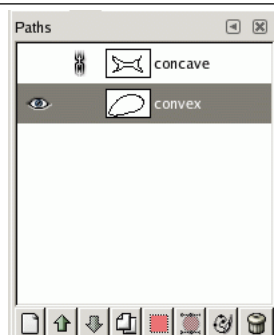
15.2.2.4.4 Usage

1. **Open** an image or begin a **new document**.
2. Activate the Quickmask using the left-bottom button in the image window. If a selection is present the mask is initialized with the content of the selection.
3. Choose a **drawing tool** and use it with grayscale colors on the QuickMask.
4. Deactivate the Quickmask using the left-bottom button in the image window.

15.2.3 Paths Dialog

Please see Section 7.5 if you don't know what a path is.


Figure 15.14 The "Paths" dialog



The "Paths" dialog is used to manage paths, allowing you to create or delete them, save them, convert them to and from selections, etc.

15.2.3.1 Activating the dialog

The “Paths” dialog is a dockable dialog; see the section Section 3.2.3 for help on manipulating it. You can access it:

- from the image menu: Windows → Dockable Dialogs → Paths.
- from the Tab menu in any dockable dialog by clicking on  and selecting Add Tab → Paths,

In the Windows menu, there is a list of **detached windows** which exists only if at least one dialog remains open. In this case, you can raise the “Paths” dialog from the image-menu: Windows → Paths.

15.2.3.2 Using the Paths dialog

Each path belongs to one image: paths are components of images just like layers. The Paths dialog shows you a list of all paths belonging to the currently active image: switching images causes the dialog to show a different list of paths. If the Paths dialog is embedded in a “Layers, Channels, and Paths” dock, you can see the name of the active image in the Image Menu at the top of the dock. (Otherwise, you can add an Image Menu to the dock by choosing “Show Image Menu” from the Tab menu.)

If you are familiar with the Layers dialog, you have a head start, because the Paths dialog is in several ways similar. It shows a list of all paths that exist in the image, with four items for each path:



Path visibility An “open eye” icon if the path is visible, or a blank space if it is not. “Visible” means that a trace of the path is drawn on the image display. The path is not actually shown in the image pixel data unless it has been stroked or otherwise rendered. Clicking in the eye-symbol-space toggles the visibility of the path.



Chain paths A “chain” symbol is shown to the right of the eye-symbol-space if the path is transform-locked, or a blank space if it is not. “Transform-locked” means that it forms part of a set of elements (layers, channels, etc) that are all affected in the same way by transformations (scaling, rotation, etc) applied to any one of them. Clicking in the chain-symbol-space toggles the transform-lock status of the path.

Preview image A small preview-icon showing a sketch of the path. If you click on the icon and drag it into an image, this will create a copy of the path in that image.

Path Name The name of the path, which must be unique within the image. Double-clicking on the name will allow you to edit it. If the name you create already exists, a number will be appended (e.g., “#1”) to make it unique.

If the list is non-empty, at any given moment one of the members is the image’s *active path*, which will be the subject of any operations you perform using the dialog menu or the buttons at the bottom: the active path is shown highlighted in the list. Clicking on any of the entries will make it the active path.

Right-clicking on any entry in the list brings up the **Paths Menu**. You can also access the Paths Menu from the dialog Tab menu.

15.2.3.3 Buttons

The buttons at the bottom of the Paths dialog all correspond to entries in the Paths menu (accessed by right-clicking on a path list entry), but some of them have extra options obtainable by holding down modifier keys while you press the button.

New Path See **New Path**. Holding down the **Shift** key brings up a dialog that allows you to assign a name to the new (empty) path.

Raise Path See **Raise Path**.

Lower Path See **Lower Path**.

Duplicate Path See [Duplicate Path](#).

Path to Selection Converts the path into a selection; see [Path to Selection](#) for a full explanation. You can use modifier keys to set the way the new selection interacts with the existing selection:

Modifiers: None, Action: Replace existing selection

*Modifiers: **Shift**, Action: Add to selection*

*Modifiers: **Ctrl**, Action: Subtract from selection*

Modifiers: Shift-Ctrl, Action: Intersect with selection.

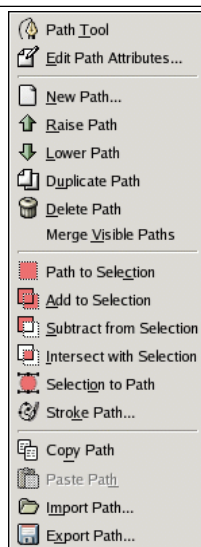
Selection to Path Holding down the **Shift** key brings up the Advanced Options dialog, which probably is only useful to GIMP developers.

Paint along the path See [Stroke Path](#).

Delete Path Delete Path deletes the current selected path.

15.2.3.4 The “Paths” context menu

Figure 15.15 The “Paths” context menu



The Paths menu can be brought up by right-clicking on a path entry in the list in the Paths dialog, or by choosing the top entry (“Paths Menu”) from the Paths dialog Tab menu. This menu gives you access to most of the operations that affect paths.

Path Tool Path Tool is an alternative way to activate the [Path tool](#), used for creating and manipulating paths. It can also be activated from the Toolbox, or by using the keyboard shortcut **B** (for *Bézier*).

Edit Path Attributes Edit Path Attributes brings up a small dialog that allows you to change the name of the path. You can also do this by double-clicking on the name in the list in the Paths dialog.

New Path New Path creates a new path, adds it to the list in the Paths dialog, and makes it the active path for the image. It brings up a dialog that allows you to give a name to the path. The new path is created with no anchor points, so you will need to use the Path tool to give it some before you can use it for anything.

Raise Path Raise Path moves the path one slot higher in the list in the Paths dialog. The position of a path in the list has no functional significance, so this is simply a convenience to help you keep things organized.

Lower Path Lower Path moves the path one slot lower in the list in the Paths dialog. The position of a path in the list has no functional significance, so this is simply a convenience to help you keep things organized.


Duplicate Path “Duplicate Path” creates a copy of the active path, assigns it a unique name, adds it to the list in the Paths dialog, and makes it the active path for the image. The copy will be visible only if the original path was visible.

Delete Path Delete Path deletes the current selected path.

Merge Visible Paths Merge Visible Paths takes all the paths in the image that are visible (that is, all that show “open eye” symbols in the Paths dialog), and turns them into components of a single path. This may be convenient if you want to stroke them all in the same way, etc.


Path to Selection; Add to Selection; Subtract from Selection; Intersect with Selection These commands all convert the active path into a selection, and then combine it with the existing selection in the specified ways. (“Path to Selection” discards the existing selection and replaces it with one formed from the path.) If necessary, any unclosed components of the path are closed by connecting the last anchor point to the first anchor point with a straight line. The “marching ants” for the resulting selection should closely follow the path, but don’t expect the correspondence to be perfect.

Selection to Path This operation can be accessed in several ways:


- From an image menubar, as Select → To Path
- From the Paths dialog menu, as Selection to Path.
- From the Selection to Path button  at the bottom of the Paths dialog.

Selection to Path creates a new path from the image’s selection. In most cases the resulting path will closely follow the “marching ants” of the selection, but the correspondence will not usually be perfect.

Converting a two-dimensional selection mask into a one-dimensional path involves some rather tricky algorithms: you can alter the way it is done using the Advanced Options, which are accessed

by holding down the **Shift** key while pressing the Selection to Path button  at the bottom of the Paths dialog. This brings up the Advanced Options dialog, which allows you to set 20 different options and variables, all with cryptic names. The Advanced Options are really intended for developers only, and help with them goes beyond the scope of this documentation. Generally speaking, Selection to Path will do what you expect it to, and you don’t need to worry about how it is done (unless you want to).

Stroke Path This operation can be accessed in several ways:

- From an image menubar, as Edit → Stroke Path
- From the Paths dialog menu, as Stroke Path.
- From the Paint along the path button  at the bottom of the Paths dialog.
- From the Stroke Path button in the Tool Options for the Path tool.

“Stroke Path” renders the active path on the active layer of the image, permitting a wide variety of line styles and stroking options. See the section on **Stroking** for more information.

Copy Path Copy Path copies the active path to the Paths Clipboard, enabling you to paste it into a different image.

Tip



You can also copy and paste a path by dragging its icon from the Paths dialog into the target image’s display.

Note

When you copy a path to an image, it is not visible. You have to make it visible in the Path dialog.

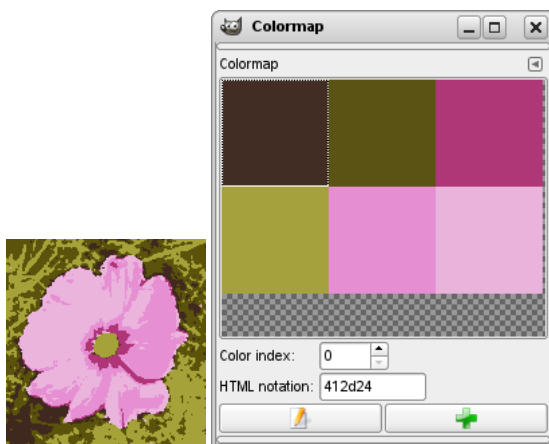
Paste Path Paste Path creates a new path from the contents of the Path Clipboard, adds it to the list in the Paths dialog, and makes it the active path for the image. If no path has previously been copied into the clipboard, the menu entry will be insensitive.

Import Path Import Path creates a new path from an SVG file: it pops up a file chooser dialog that allows you to navigate to the file. See the [Paths](#) section for information on SVG files and how they relate to GIMP paths.

Export Path Export Path allows you to save a path to a file: it pops up a file save dialog that allows you to specify the file name and location. You can later add this path to any GIMP image using the Import Path command. The format used for saving paths is SVG: this means that vector-graphics programs such as Sodipodi or Inkscape will also be able to import the paths you save. See the [Paths](#) section for more information on SVG files and how they relate to GIMP paths.

15.2.4 Colormap Dialog


Figure 15.16 An indexed image with 6 colors and its Colormap dialog



The Colormap (Indexed Palette is a better name) dialog allows you to edit the colormap of an indexed image. (If the mode of the active image is RGB or Grayscale instead of Indexed, the dialog is empty and unusable.) This is a dockable dialog; see the section on [Dialogs and Docking](#) for help on manipulating it.

15.2.4.1 Activating the dialog

The “Colormap” dialog is a dockable dialog; see the section [Section 3.2.3](#) for help on manipulating it. You can access it:

- from the image menu: Windows → Dockable Dialogs → Colormap;
- from the Tab menu in any dockable dialog by clicking on  and selecting Add Tab → Colormap.

In the Windows menu, there is a list of [detached windows](#) which exists only if at least one dialog remains open. In this case, you can raise the “Colormap” dialog from the image-menu: Windows → Colormap.

15.2.4.2 Colormaps and Indexed Images

In an Indexed image, instead of being assigned a color directly (as happens in RGB and Grayscale images), colors are assigned to pixels by an indirect method, using a look-up table called a *colormap*.

To determine the color that should be shown for that pixel, GIMP looks up the index in the image's colormap. Each indexed image has its own private colormap. In GIMP, the maximum number of entries in a colormap is 256. For a maximum-sized colormap, each index from 0 to 255 is assigned an arbitrary RGB color. There are no rules restricting the colors that can be assigned to an index or the order they appear in: any index can be assigned any color.

It is important to realize that the colors in the colormap are the *only colors available* for an indexed image (that is, unless you add new colors to the colormap). This has a major effect on many GIMP operations: for example, in a pattern fill, GIMP will usually not be able to find exactly the right colors in the colormap, so it will approximate them by using the nearest color available. This is sometimes referred to as **Quantization**. If the colormap is too limited or poorly chosen, this can easily produce very poor image quality.

The Colormap dialog allows you to alter the colormap for an image, either by creating new entries, or by changing the colors for the existing entries. If you change the color associated with a given index, you will see the changes reflected throughout the image, as a color shift for all pixels that are assigned that index. The entries are numbered with 0 in the upper left corner, 1 to its right, etc.

15.2.4.3 Using the Colormap dialog

Here are the operations you can perform using this dialog:

Click on a color entry This sets GIMP's foreground color to the color you click on, as shown in the Toolbox color area. As a result, this color will be used for the next painting operation you do.

Ctrl-click on a color entry This sets GIMP's background color to the color you **Ctrl**-click on, as shown in the Toolbox color area.

Double-click on a color entry This sets GIMP's foreground color to the color you click on, and also brings up a Color Editor that allows you to change that colormap entry to a new color.

Color index You can select a different colormap entry by typing its index here, or clicking the spinbutton to the right.

HTML-Notation This area shows a hex-code representation (such as is used in HTML) for the color assigned to the currently selected colormap entry. You can edit the color here, instead of using a Color Editor, if you want to. See **HTML notation**

Edit color This button (in the lower left corner of the dialog) brings up a Color Editor that allows you to change the color for the currently selected colormap entry. The effect is similar to double-clicking on the entry, except that it does not set GIMP's foreground color.

✚ **Add color** This button (in the lower right corner of the dialog) allows you to add new colors to the colormap. If you click on the button, the current foreground color, as shown in the Toolbox, will be tacked on to the end of the colormap. If instead you hold down **Ctrl** and click, the background color from the Toolbox will be added. (If the colormap contains 256 entries, it is full, and trying to add more will have no effect.)

Tip



If you make a mistake, you can undo it by focusing the pointer in the image whose colormap you have changed, and then pressing Ctrl-Z or choosing Edit → Undo in the image menu.

Note

This dialog provides the most commonly used methods for altering the colormap for an indexed image. The color tools, such as Brightness/Contrast, Hue/Saturation, etc, do not operate on indexed images. There are a few plug-ins that do so, including the “Normalize”, “VColor Enhance”, and “Stretch Contrast” operations, and it is possible to create others as well.

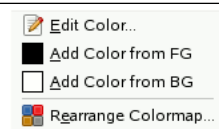
Note

If you paint an indexed image with a color which is not in the Colormap, GIMP will use the most similar color of the Colormap.

15.2.4.4 The Colormap context menu

Right-clicking on a color in the Colormap selects this color and opens a pop-up submenu:

Figure 15.17 The Colormap context menu



Edit color This command opens a color selector which allows you to modify the color.

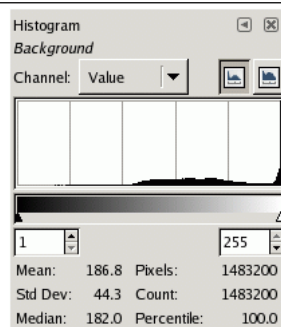
Add Color from FG This command is enabled only if the indexed palette contains less than 256 colors. The background color of the Toolbox is appended to the color map.

Add Color from BG This command is enabled only if the indexed palette contains less than 256 colors. The background color of the Toolbox is appended to the color list.

Rearrange Colormap Rearrange Colormap: This command is described in Section [16.8.33](#).

15.2.5 Histogram dialog

Figure 15.18 The Histogram dialog




The Histogram dialog shows you information about the statistical distribution of color values in the active layer or selection. This information is often useful when you are trying to *color balance* an image.

However, the Histogram dialog is purely informational: nothing you do with it will cause any change to the image. If you want to perform a histogram-based color correction, use the [Levels](#) tool.

15.2.5.1 Activating the dialog

The “Histogram” dialog is a dockable dialog; see the section [Section 3.2.3](#) for help on manipulating it. You can access it:

- from the image menu: Windows → Dockable Dialogs → Histogram.
- from the Tab menu in any dockable dialog by clicking on  and selecting Add Tab → Histogram,
- from the image menu: Colors → Info → Histogram.

In the Windows menu, there is a list of [detached windows](#) which exists only if at least one dialog remains open. In this case, you can raise the “Histogram” dialog from the image-menu: Windows → Histogram.

15.2.5.2 About Histograms

In GIMP, each layer of an image can be decomposed into one or more color channels: for an RGB image, into R, G, and B channels; for a grayscale image, into a single Value channel. Layers that support transparency have an additional channel, the alpha channel. Each channel supports a range of intensity levels from 0 to 255 (integer valued). Thus, a black pixel is encoded by 0 on all color channels; a white pixel by 255 on all color channels. A transparent pixel is encoded by 0 on the alpha channel; an opaque pixel by 255.

For RGB images, it is convenient to define a Value “pseudochannel”. This is not a real color channel: it does not reflect any information stored directly in the image. Instead, the Value at a pixel is given by the equation $V = \max(R, G, B)$. Essentially, the Value is what you would get at that pixel if you converted the image to Grayscale mode.

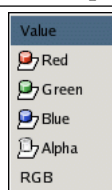
For more information on channels, please consult the [Section 5.1](#).

15.2.5.3 Using the Histogram dialog

The active layer name is shown at the top of the dialog.

Channel

Figure 15.19 Channel options for an RGB layer with alpha channel



This allows you to select which channel to use. The possibilities depend on the layer type of the active layer. Here are the entries you might see, and what they mean:

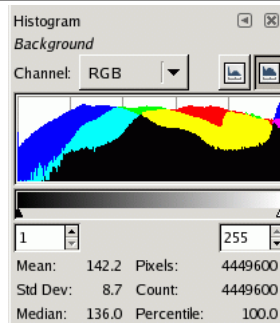
Value For RGB and Grayscale images, this shows the distribution of brightness values across the layer. For a grayscale image, these are read directly from the image data. For an RGB image, they are taken from the Value pseudochannel.

For an indexed image, the “Value” channel actually shows the distribution of frequencies for each colormap index: thus, it is a “pseudocolor” histogram rather than a true color histogram.

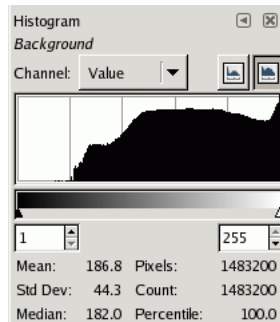
Red, Green, Blue These only appear for layers from RGB images. They show the distribution of intensity levels for the Red, Green, or Blue channels respectively.

Alpha This shows the distribution of opacity levels. If the layer is completely transparent (alpha = 0) or completely opaque (alpha = 255), the histogram will consist of a single bar on the left or right edge.

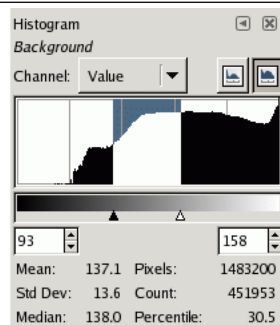
RGB

Figure 15.20 Combined histograms of R, G, and B channels.

This entry, only available for RGB layers, shows the R, G, and B histograms superimposed, so that you can see all of the color distribution information in a single view.

Linear / **Logarithmic** buttons**Figure 15.21** The histogram shown at the top, changed to logarithmic mode.

These buttons determine whether the histogram will be displayed using a linear or logarithmic Y axis. For images taken from photographs, the linear mode is most commonly useful. For images that contain substantial areas of constant color, though, a linear histogram will often be dominated by a single bar, and a logarithmic histogram will often be more useful.

Range Setting**Figure 15.22** Dialog aspect after range fixing.

You can restrict the analysis, for the statistics shown at the bottom of the dialog, to a limited range of values if you wish. You can set the range in one of three ways:

- Click and drag the pointer across the histogram display area, from the lowest level to the highest level of the range you want.
- Click and drag the black or white triangles on the slider below the histogram.

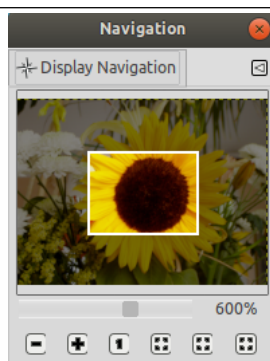
- Use the spinbutton entries below the slider (left entry: bottom of range; right entry: top of range).

Statistics At the bottom of the dialog some basic statistics are shown describing the distribution of channel values, restricted to the selected range:

- Mean : the mean value of the interval in the selected channel.
- Std Dev : Standard deviation. Gives an idea about how homogeneous the distribution of values in the interval is.
- Median : For example, the value of the fiftieth peak in a 100 peaks interval.
- Pixels : The number of pixels in the active layer or selection.
- Count : The number of pixels in a peak (when you click on the histogram) or in the interval.
- Percentile : The ratio between the number of pixels in the interval and the total number of pixels in the active layer or selection.

15.2.6 Navigation Dialog

Figure 15.23 Navigation Dialog




The Navigation dialog is designed to offer easy movement around the active image if the zoom is set higher than what the image window can display. If this is the case, there is an white colored rectangle that shows the location of the current view area in respect to the image. In this rectangle, the mouse pointer takes the form of a grabbing hand; outside this rectangle, it takes the form of a hand with pointing fore-finger.

To change the viewing region:

- Click outside the rectangular area with the pointing fore-finger on the wanted region.
- Click and drag the rectangular area.
- Use **Shift** and mouse-wheel to move horizontally, **Alt** and mouse-wheel to move vertically.

15.2.6.1 Activating the dialog

The “Navigation” dialog is a dockable dialog; see the section Section 3.2.3 for help on manipulating it. You can access it:

- from the image menu: Windows → Dockable Dialogs → Navigation;
- from the Tab menu in any dockable dialog by clicking on  and selecting Add Tab → Navigation,
- from the image-menu: View → Navigation window.
- You can access more quickly to it (but without the zoom functions) by clicking on the icon at the right bottom corner of the image window:



15.2.6.2 Using the Navigation Dialog

The slider It allows easy zoom level control, more precise than with the **Zoom** command. This slider can also be moved using the mouse wheel when the mouse pointer is on the slider, or **Ctrl** and mouse wheel.

The buttons *Zoom Out*  *Zoom In*  and *Zoom 1:1*  are self explanatory.

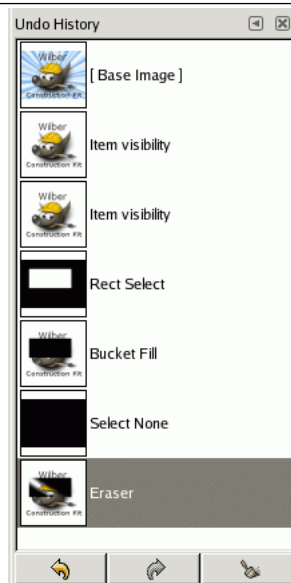
Adjust the zoom ratio so that the image becomes fully visible The zoom ratio is adjusted so that the whole image becomes visible in the window as it is.

Adjust the zoom ratio so that the window is used optimally The image size and the zoom are adjusted so that the image is fully displayed with the lesser zoom.

Reduce the image window to the size of the image display Restore the image window to the size which allows the image to be fully displayed with the zoom unchanged. This command is also as menu entry available. See Section 16.5.7 for the details.

15.2.7 Undo History Dialog

Figure 15.24 The Undo History dialog




This dialog shows you a list of the actions you have most recently performed on an image, with a small sketch that attempts to illustrate the changes produced by each. You can revert the image to any point in its Undo History simply by clicking on the right entry in the list. For more information on GIMP's Undo mechanism and how it works, see the section on **Undoing**.

15.2.7.1 Activating the dialog

The "Undo History" dialog is a dockable dialog; see the section Section 3.2.3 for help on manipulating it.

You can access it:

- from the image menu: Windows → Dockable Dialogs → Undo History.
- from the Tab menu in any dockable dialog by clicking on  and selecting Add Tab → Undo History.

15.2.7.2 Using the Undo History dialog


The most basic thing you can do is to select a point in the Undo History by clicking on it in the list. You can go back and forth between states in this way as much as you please, without losing any information or consuming any resources. In most cases, the changes are very fast.


Tip




Ctrl-F opens a search field. See [View as List](#); [View as Grid](#)

At the bottom of the dialog are three buttons:


-  **Undo** This button has the same effect as choosing Edit → Undo from the menu, or pressing Ctrl-Z; it reverts the image to the next state back in the undo history.

-  **Redo** This button has the same effect as choosing Edit → Redo from the menu, or pressing Ctrl-Y; it advances the image to the next state forward in the Undo History.

-  **Clear Undo History** This button removes all contents from the undo history except the current state. If you press it, you are asked to confirm that you really want to do this. The only reason for doing it would be if you are very constrained for memory.

Note



In a tab, this dialog is represented by 

Note

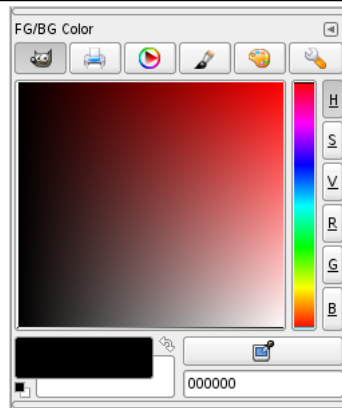


You can set the number of undo levels in [System Resources](#).

15.3 Image-content Related Dialogs

15.3.1 FG/BG Color Dialog

Figure 15.25 The FG/BG Color dialog



The Color dialog lets you manage and pick up new colors. You can use it into five different modes: GIMP, CMYK, Triangle, Watercolor and Scales. It has an interesting eyedropper to pick up a color anywhere on your screen.

The dialog called from the FG/BG area in the toolbox is a bit different compared to the one called from the image menu:


- the sliders are permanently visible instead of selected from the scale menu,
- twelve buttons show the last used colors. You may choose a color by clicking on one of these buttons or add the current FG or BG color to this history list.

This dialog works either on the foreground or the background color.

15.3.1.1 Activating the Dialog

The “Colors” dialog is a dockable dialog; see the section Section 3.2.3 for help on manipulating it.

You can access it:

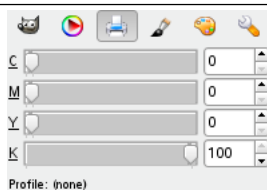
- from an image menu: Windows → Dockable Dialogs → Colors;
- from the Tab menu in any dockable dialog by clicking on  and selecting Add Tab → Colors,
- from the toolbox: click on the current Foreground or Background color.

In the Windows menu, there is a list of **detached windows** which exists only if at least one dialog remains open. In this case, you can raise the “Colors” dialog from the image-menu: Windows → Colors.

15.3.1.2 Using the “FG/BG color” dialog

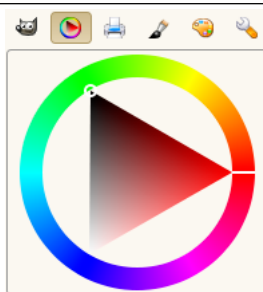
GIMP Selector With the GIMP Color Selector, you select a color by clicking on a one-dimensional strip located at the right edge, and then in a two-dimensional area located on the left. The one-dimensional strip can encode any of the color parameters H, S, V, R, G, or B, as determined by which of the adjoining buttons is pressed. The two-dimensional area then encodes the two complementary color parameters.

CMYK

Figure 15.26 CMYK

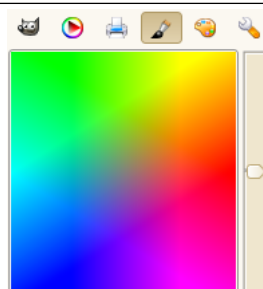
You get to this selector by clicking on the printer icon. The CMYK view gives you the possibility to manage colors from the **CMYK** color model.

Triangle

Figure 15.27 The triangle selector

This selector uses the **HSV** color model. Click in the *chromatic circle* and drag the mouse pointer to select the Hue. Click-and-drag in the *triangle* to vary intuitively Saturation (vertically) and Value (horizontally).

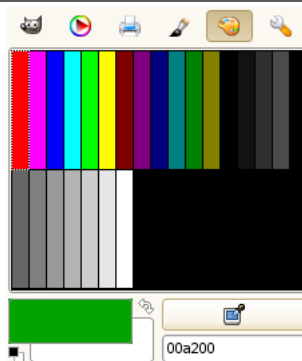
Watercolor

Figure 15.28 Watercolor Color Selector

This color selector is symbolized by a brush. The function mode of this selector is a little different from that of models presented so far. The principle consists in changing the current foreground color by clicking in the rectangular palette. If the current foreground color is for example white, then it turns to reddish by clicking in the red color area. Repeated clicking strengthens the effect. With the slider, which is right apart from the color palette, you can set the color quantity per every mouse click. The higher the sliding control is, the more color is taken up per click.

Palette

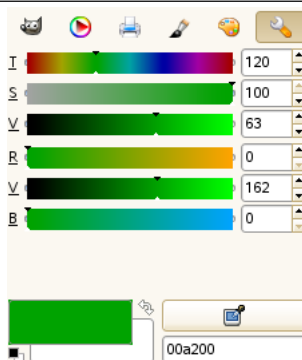
Figure 15.29 Palette Color Selector



This color selector brings up a list of the colors of the current palette in the **Palettes dialog**. You can set GIMP's foreground or background colors by clicking on colors in the colors display. You can also use the arrow keys to move within the list of colors.

Scales

Figure 15.30 The Scales selector



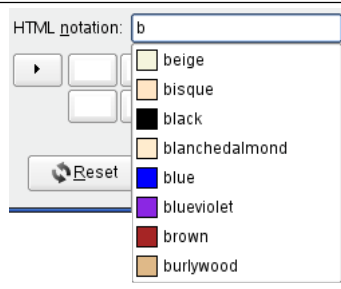
This selector displays a global view of R, G, B channels and H, S, V values, placed in sliders.

Color picker The color picker has a completely different behavior, than the **color picker tool**. Instead of picking the colors from the active image, you're able to pick colors from the entire screen.

The downside is that you get colors after they got processed by the full system color stack, in particular color management. It means that the resulting color values may end up different from ones returned by the **color picker tool** when picking over the canvas. It is up to you to make an informed choice of which color picker to use.

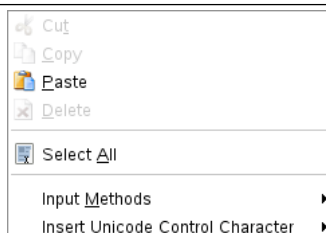
HTML Notation See **HTML notation**. You can also use the CSS keywords; enter the first letter of a color to get a list of colors with their keyword :

Figure 15.31 CSS keywords example



Right-clicking in the HTML Notation text box opens a context menu that allows you to edit your notation, particularly to paste a complex notation you have copied elsewhere. This menu leads to various Input Methods that allow you to use foreign characters, and to the possibility to Insert Unicode Control Characters. This is a vast field, beyond this help. Please see [[UNICODE](#)].

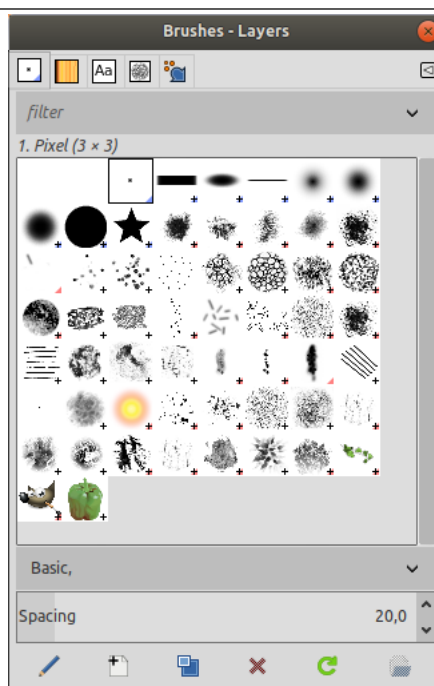
Figure 15.32 The HTML Notation context menu



Right up you find a symbol, consisting of two arrows, with which you can exchange the foreground and background color. At the bottom left of the dialog, just below the foreground color block, you find a switching surface with two small, one black and the other white, partially overlapping squares. If you click on these, the front and background color are put back to black and white respectively.

15.3.2 Brushes Dialog

Figure 15.33 The Brushes dialog




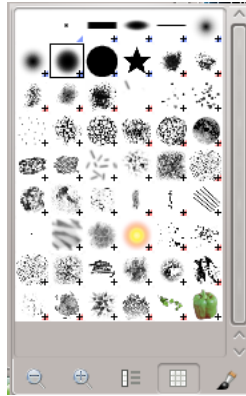
The “Brushes” dialog is used to select a brush, for use with painting tools: see the [Brushes](#) section for basic information on brushes and how they are used in GIMP. The dialog also gives you access to several functions for manipulating brushes. You can select a brush by clicking on it in the list: it will then be shown in the Brush/Pattern/Gradient area of the Toolbox. GIMP comes now with 56 brushes, different from each other, because the size, the ratio and the angle of every brush can be set in the tool options dialog. You can also create custom brushes using the Brush Editor, or by saving images in a special brush file format.

15.3.2.1 Activating the Dialog

The “Brushes” dialog is a dockable dialog; see the section [Section 3.2.3](#) for help on manipulating it.

You can access it:

- from the Toolbox, by clicking on the brush symbol in the Brush/Pattern/Gradient area (if you have checked the “Show active brush, pattern and gradient” option in the toolbox preferences).
- From an image menu: Windows → Dockable Dialogs → Brushes;
- from the Tab menu in any dockable dialog by clicking on  and selecting Add Tab → Brushes.
- from the Tool Options dialog for any of the paint tools, by clicking on the Brush icon button, you get a popup with similar functionality that permits you to quickly choose a brush from the list; if you click on the button present on the right bottom of the popup, you open the real brush dialog.



The simplified “Brushes” dialog

This window has five buttons, clearly explained by help pop-ups:

- Smaller previews
- Larger previews
- View as list
- View as Grid
- Open the brush selection dialog

Note that, depending on your Preferences, a brush selected with the popup may only apply to the currently active tool, not to other paint tools. See the [Tool Option Preferences](#) section for more information.

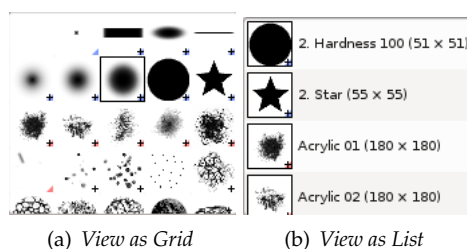
15.3.2.2 Using the “Brushes” dialog

15.3.2.2.1 Grid/List mode

In the Tab menu, you can choose between View as Grid and View as List. In Grid mode, the brush shapes are laid out in a rectangular array, making it easy to see many at once and find the one you are looking for. In List mode, the shapes are lined up in a list, with the names beside them.

In the Tab menu, the option Preview Size allows you to adapt the size of brush previews to your liking.

Figure 15.34 Grid/List view



Grid mode At the top of the dialog appears the name of the currently selected brush, and its size in pixels.

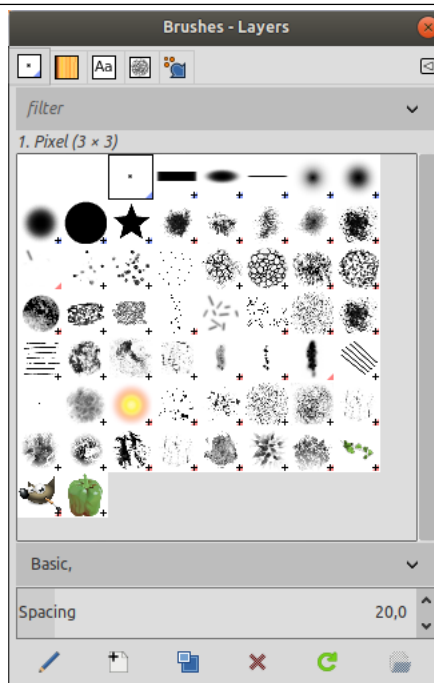
In the center a grid view of all available brushes appears, with the currently selected one outlined.

List mode For the most part, the dialog works the same way in List mode as in Grid mode, with one exception:

If you double-click on the *name* of a brush, you will be able to edit it. Note, however, that you are only allowed to change the names of brushes that you have created or installed yourself, not the ones that come pre-installed with GIMP. If you try to rename a pre-installed brush, you will be able to edit the name, but as soon as you hit return or click somewhere else, the name will revert to its original value. It is a general rule that you cannot alter the resources that GIMP pre-installs for you: brushes, patterns, gradients, etc; only ones that you create yourself.

15.3.2.2.2 Brush previews

Figure 15.35 The “Brushes” dialog



When you click on a brush preview, it becomes the current brush and it gets selected in the brush area of Toolbox and the Brush option of painting tools. When you double-click on a brush preview, you will activate the **Brush Editor**. You can also click on buttons at the bottom of the dialog to perform various actions.

Meaning of the small symbols at the bottom right corner of every brush preview:

- A blue corner is for brushes in normal size. You can duplicate them.
- A small cross means that the brush preview is in a reduced size. You can get it in normal size by maintaining left click on it.
- A red corner is for animated brushes. If you maintain left click on the thumbnail, the animation is played.

15.3.2.2.3 Tagging

You can use tags to reorganize the brushes display. See Section 15.3.6.

15.3.2.2.4 Buttons at the bottom

At the bottom of the dialog you find a slider and some buttons:



Spacing This slider lets you set the distance between consecutive brush marks when you trace out a brushstroke with the mouse pointer. Spacing is a percentage of the brush width.

Edit Brush This activates the **Brush Editor**. Pressing the button will open the Editor for any brush. It only works, however, for parametric brushes: for any other type, the Editor will show you the brush but not allow you to do anything with it.

New Brush This creates a new parametric brush, initializes it with a small fuzzy round shape, and opens the Brush Editor so that you can modify it. The new brush is automatically saved in your personal `brushes` folder.

Duplicate Brush This button is only enabled if the currently selected brush is a parametric brush. If so, the brush is duplicated, and the Brush Editor is opened so that you can modify the copy. The result is automatically saved in your personal `brushes` folder.

Delete Brush This option is active for parametric brushes only. This removes all traces of the brush, both from the dialog and the folder where its file is stored, if you have permission to do so. It asks for confirmation before doing anything.

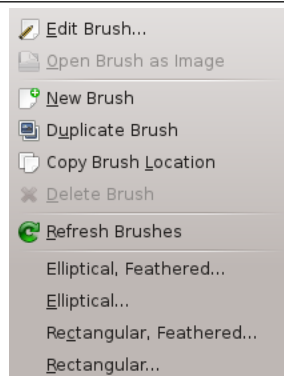
Refresh Brushes If you add brushes to your personal `brushes` folder or any other folder in your brush search path, by some means other than the Brush Editor, this button causes the list to be reloaded, so that the new entries will be available in the dialog.

Open brush as image New option in GIMP-2.10.10: you can edit this image, copy it and Edit>Paste as>New brush. This is different from Section 15.3.2.3 that allows to modify an existing brush.

The functions performed by these buttons can also be accessed from the dialog pop-up menu, activated by right-clicking anywhere in the brush grid/list, or by choosing the top item, Brushes menu, from the dialog Tab menu.

15.3.2.2.5 The “Brushes” context menu

Figure 15.36 The “Brushes” context menu

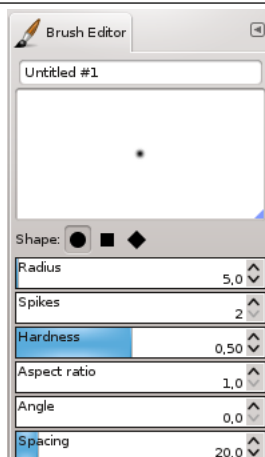


Right clicking on a brush preview opens a context menu. This menu has now some options which let you create elliptical and rectangular brushes. These brushes can be feathered, but they are not parametric brushes.

The other commands of this submenu are described with the Buttons, except for Copy Brush Location which allows to copy brush path into clipboard. By using the File → Open Location, command, you can open the brush as a new image.

15.3.2.3 Brush Editor

Figure 15.37 The “Brushes” Editor dialog



The Brush Editor, activated for a new brush.

The Brush Editor allows you to view the brush parameters of a brush supplied by GIMP, and you can't change them. You can also create a custom brush: click on the New Brush button to activate the functions of the brush editor; you can select a geometrical shape, a circle, a square or a diamond. This editor has several elements:

The dialog bar: As with all dialog windows, a click on the small triangle prompts a menu allowing you to set the aspect of the Brush Editor.

The title bar: To give a name to your brush.

The preview area: Brush changes appear in real time in this preview.

Settings:

Shape A circle, a square and a diamond are available. You will modify them by using the following options:

Radius Distance between brush center and edge, in the width direction. A square with a 10 pixels radius will have a 20 pixels side. A diamond with a 5 pixels radius will have a 10 pixels width.

Spikes This parameter is useful only for square and diamond. With a square, increasing spikes results in a polygon. With a diamond, you get a star.

Hardness This parameter controls the feathering of the brush border. Value = 1.00 gives a brush with a sharp border (0.00-1.00).

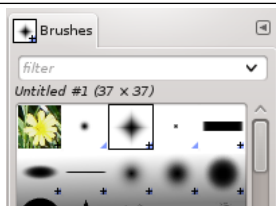
Aspect ratio This parameter controls the brush Width/Height ratio. A diamond with a 5 pixels radius and an Aspect Ratio = 2, will be flattened with a 10 pixels width and a 5 pixels height (1.0-20.0).

Angle This angle is the angle between the brush width direction, which is normally horizontal, and the horizontal direction, counter-clock-wise. When this value increases, the brush width turns counter-clock-wise (0° to 180°).

Spacing When the brush draws a line, it actually stamps the brush icon repeatedly. If brush stamps are very close, you get the impression of a solid line: you get that with Spacing = 1. (1.00 to 200.0).

15.3.2.4 The Clipboard Brush

When you use the Copy or Cut command on an image or a selection of it, a copy appears as a new brush in the upper left corner of the “Brushes” dialog. This brush will persist until you use the Copy command again. It disappears when you close GIMP.

Figure 15.38 A new “Clipboard Brush”**Note**

You can save this clipboard brush by using the **Edit → Paste as → New brush as** soon as it appears in the “Brushes” dialog. (See Section [16.3.12.4.](#))

15.3.3 Patterns Dialog

In GIMP, a *pattern* is a small image used to fill areas by placing copies of side by side. See the [Patterns](#) section for basic information on patterns and how they can be created and used.


You can use them with the **Bucket Fill** and **Clone** tools and the **Fill with pattern** command.

The “Patterns” dialog is used to select a pattern, by clicking on it in a list or grid view: the selected pattern will then be shown in the Brush/Pattern/Gradient area of the Toolbox. A few dozen more or less randomly chosen patterns are supplied with GIMP, and you can easily add new patterns of your own.

15.3.3.1 Activating the dialog

The “Patterns” dialog is a dockable dialog; see the section [Section 3.2.3](#) for help on manipulating it.

You can access it:

- From the Toolbox, by clicking on the pattern symbol in the Brush/Pattern/Gradient area (if you have checked the “Show active brush, pattern and gradient” option in the toolbox preferences).
- from the image menu: **Windows → Dockable Dialogs → Patterns**;
- from the Tab menu in any dockable dialog by clicking on  and selecting **Add Tab → Patterns**.
- From the Tool Options dialog of the **Clone tool** and the **Bucket Fill tool**, by clicking on the pattern source button, you get a pop-up with similar functionality that permits you to quickly choose a pattern from the list; if you clic on the Bucket Fill button present on the right bottom of the pop-up, you open the real pattern dialog. Note that, depending on your Preferences, a pattern selected with the pop-up may only apply to the currently active tool, not to other paint tools. See the [Tool Option Preferences](#) section for more information.

15.3.3.2 Using the pattern dialog

Grid/List modes In the Tab menu, you can choose between **View as Grid** and **View as List**. In Grid mode, the patterns are laid out in a rectangular array, making it easy to see many at once and find the one you are looking for. In List mode, the patterns are lined up in a list, with the names beside them.

Tip



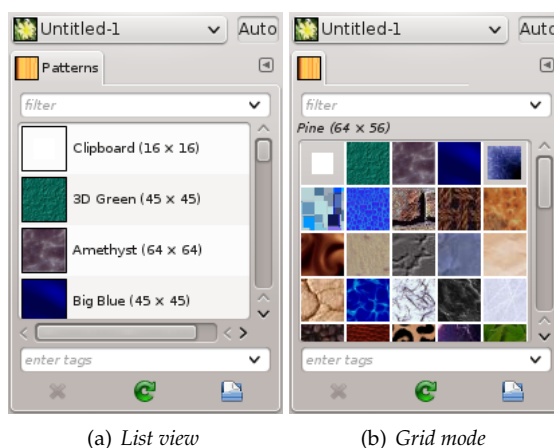
Independent of the real size of a pattern all patterns are shown the same size in the dialog. So for larger patterns this means that you see only a small portion of the pattern in the dialog at all - no matter whether you view the dialog in the list or the grid view. To see the full pattern you simply click on the pattern *and hold the mouse button* for a second.

Note



In the Tab menu, the option Preview Size allows you to adapt the size of pattern previews to your liking.

Figure 15.39 The Patterns dialog



(a) List view

(b) Grid mode

Using the Patterns dialog (Grid mode) At the top appears the name of the currently selected patterns, and its dimensions in pixels.

In the center appears a grid view of all available patterns, with the currently selected one outlined. Clicking on one of them sets it as GIMP's current pattern, and causes it to appear in the Brush/Pattern/Gradient area of the Toolbox.


Using the Patterns dialog (List view) In this view, instead of a grid, you see a list of patterns, each labeled with its name and size. Clicking on a row in the list sets that pattern as GIMP's current pattern, just as it does in the grid view.

If you *double-click* on the name of a pattern, you will be able to edit the name. Note that you are only allowed to rename patterns that you have added yourself, not the ones that are supplied with GIMP. If you edit a name that you don't have permission to change, as soon as you hit return or move to a different control, the name will revert back to its previous value.

Everything else in the List view works the same way as it does in the Grid view.

✗ Delete Pattern Pressing this button removes the pattern from the list and causes the file representing it to be deleted from disk. Note that you cannot remove any of the patterns that are supplied with GIMP and installed in the system `patterns` directory; you can only remove patterns that you have added to folders where you have write permission.

🔄 Refresh Patterns Pressing this button causes GIMP to rescan the folders in your pattern search path, adding any newly discovered patterns to the list. This button is useful if you add new patterns to a folder, and want to make them available without having to restart GIMP.

 **Open pattern as image** If you click on this button, the current pattern is opened in a new image window. So, you can edit it. But if you try to save it with the `.pat`, even with a new name, you will bang into a “Denied permission ” problem because this image file is “root”. But this is possible under Windows, less protected.

15.3.3.3 Tagging

You can use tags to reorganize the patterns display. See Section [15.3.6](#).

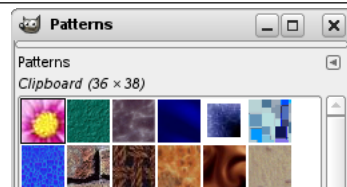
15.3.3.4 The Pattern context menu

You get it by right-clicking on the “Patterns” dialog. The commands of this menu are described with Buttons, except for Copy Location which allows to copy the path to pattern into clipboard.

15.3.3.5 The Clipboard pattern

When you use the Copy or Cut command, a copy appears as a new pattern in the upper left corner of the Patterns dialog. This brush will persist until you use the Copy (or Cut) command again. It will disappear when you close GIMP.

Figure 15.40 A new “Clipboard Pattern”



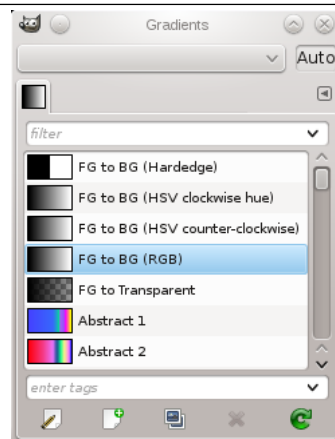
Note



You can save this clipboard pattern by using the Edit → Paste as → New pattern as soon as it appears in the Patterns dialog.

15.3.4 Gradients Dialog

Figure 15.41 The screenshot illustrates the Gradients dialog




The “Gradients” dialog offers a gradient palette which is used to select a gradient — a set of colors arranged in a linear scale — for use with the **Gradient tool** and numerous other operations. It also gives you access to several functions for manipulating gradients. You can select a gradient by clicking on it in the list: it will then be shown in the Brush/Pattern/Gradient area of the Toolbox. A few dozen nice gradients come pre-installed with GIMP. You can create more using the **Gradient Editor**. General information about gradients and how they are used in GIMP can be found in the **Gradients** section.

The first five gradients are particular: they reproduce the gradient between Foreground and background colors of toolbox in different ways.

- FG to BG (Hardedge): only black and white with a sharp limit.
- FG to BG (HSV clock-wise/counter-clockwise Hue): all hues in the color circle between the Foreground and the background color, clockwise or counter-clockwise.
- FG to BG (RGB): default gradient, between the Foreground and the background colors of the Toolbox, in the RGB mode.
- FG to Transparent: only uses one color (the Foreground color) from complete opacity to complete transparency. This gradient is very useful when you work with softly blended collages or fog effects.

15.3.4.1 Activating the Dialog

The “Gradients” dialog is a dockable dialog; see the section Section 3.2.3 for help on manipulating it. You can access it:

- from an image menu: Windows → Dockable Dialogs → Gradients;
- from the Tab menu in any dockable dialog by clicking on  and selecting Add Tab → Gradients,
- from the Toolbox, by clicking on the current gradient in the Brush/Pattern/Gradient area (if you have checked the “Show active brush, pattern and gradient” option in the toolbox preferences).
- From the image by using the Ctrl-G shortcut.

In the Windows menu, there is a list of **detached windows** which exists only if at least one dialog remains open. In this case, you can raise the “Gradients” dialog from the image-menu: Windows → Gradients.

15.3.4.2 Using the “Gradients” dialog

The most basic, and most commonly used, operation with the dialog is simply to click on one of the gradients in the scrollable list, in order to make it GIMP’s current gradient, which will then be used by any operation that involves a gradient.

If you *double-click* on a gradient, you open the Gradient Editor where you will be able to edit its name. Note, however, that you are only allowed to change the names of gradients that you have created yourself, not the ones that come pre-installed with GIMP. If you try to rename a pre-installed gradient, you will be able to edit the name, but as soon as you hit return or click somewhere else, the name will revert to its original value. It is a general rule that you cannot alter the resources that GIMP pre-installs for you: brushes, patterns, gradients, etc; only ones that you create yourself.

Grid/List modes In the Tab menu, you can choose between View as Grid and View as List. In Grid mode, the gradients are laid out in a rectangular array. They look quite dazzling when viewed this way, but it is not very easy to pick the one you want, because of visual interference from the neighboring ones. In List mode, the more usable default, the gradients are lined up vertically, with each row showing its name.

In the Tab menu, the option Preview Size allows you to adapt the size of gradient previews to your liking.

The buttons at the bottom of the dialog allow you to operate on gradients in several ways:

Edit Gradient This button activates the **Gradient Editor**.

New Gradient This creates a new gradient, initialized as a simple grayscale, and activates the Gradient Editor so that you can alter it. Gradients that you create are automatically saved in the `gradients` folder of your personal GIMP directory, from which they are automatically loaded when GIMP starts. (You can change this folder, or add new ones, using the Preferences dialog.)

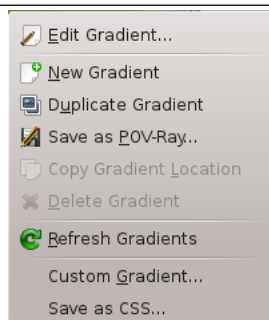
Duplicate Gradient This creates a copy of the currently selected gradient. You will be able to edit the copy even if you cannot edit the original.

Delete Gradient This removes all traces of the gradient, if you have permission to do so. It asks for confirmation before doing anything.

Refresh Gradients If you add gradients to your personal `gradients` folder by some means other than this dialog, this button causes the list to be reloaded, so that the new entries will be available.

The functions performed by these buttons can also be accessed from the dialog pop-up menu, activated by right-clicking anywhere in the gradient list, or via Gradient Menu in the Tab menu:

Figure 15.42 The Gradients Menu



The gradient menu also gives you some additional functions:

Save as POV-Ray... This allows you to save the gradient in the format used by the POV-Ray 3D ray-tracing program.

Copy Gradient Location This command allows you to copy the gradient file location to the clipboard. You can then use it in a text editor.

Custom Gradient... This command creates a sample image filled with the selected gradient. You can select width and height of the image as well as the gradient direction in the dialog window.

Save as CSS The CSS (Cascading Style Sheets) language is used to format the display of HTML and XML files, for instance background color, font size... and background gradient. The "CSS Save" plugin is a CSS3 linear gradient generator that allows you to save a CSS3 code snippet, containing the gradient data for a given GIMP gradient. This code snippet is a text file: you can copy-paste it to the stylesheet related to your HTML file, to get a gradient background on opening the HTML file in Firefox, Chrome or Safari web navigators. This CSS3 code snippet can also be used as a gradient in SVG files.

Here is an example of code snippet, got using the Blue Green gradient:

A CSS snippet created with Save as CSS

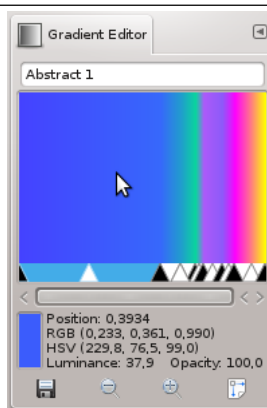
```
background-image: linear-gradient(top, rgb(0,123,255) 0%, rgb ←
    (72,226,255) 56%,
    rgb(0,255,161) 100%);
background-image: -moz-linear-gradient(center top, rgb(0,123,255) ←
    0%, rgb(72,
    226,255) 56%, rgb(0,255,
    161) 100%);
background-image: -webkit-gradient(linear, left top, left bottom,
    color-stop(0.000, rgb(0,123,255)),color-stop(0.566, rgb ←
    (72,226,255)),
    color-stop(1.000, rgb(0,255,161)));
```

15.3.4.2.1 Tagging

You can use tags to reorganize the gradients display. See Section 15.3.6.

15.3.4.3 The Gradient Editor



Figure 15.43 The gradient editor



The Gradient Editor allows you to edit the colors in a gradient. It can only be used on gradients you have created yourself (or on a copy of a system gradient), not on system gradients that come pre-installed with GIMP. This is a sophisticated tool that may take a bit of effort to understand. The concept behind it is that a gradient can be decomposed into a series of adjoining *segments*, with each segment consisting of a smooth transition from the color on the left edge to the color on the right edge. The Gradient Editor allows you to pack together any number of segments, with any colors you want for the left and right edges of each segment, and with several options for the shape of the transition from left to right.

15.3.4.3.1 How to Activate the Gradient Editor

You can activate the Gradient Editor in several ways:

- by double-clicking on the gradient stripe in the Gradient dialog,
- from the context menu you get by right clicking on the selected gradient name,
- by clicking on the Edit gradient  button in the Gradient Dialog,
- from the Gradient Menu you get by clicking on  in the Gradient Dialog.

15.3.4.3.2 Display

Name In the name area, you have the tab menu button (the small triangle).

The Gradient Preview Window Below the name, you see the current result of your work if the Instant update option is checked; else, changes will appear only when you release the mouse button.

If you simply move the mouse pointer on this display, it works somewhat as a color-picker. Values of the pointed pixel are displayed in a rather odd way. *Position* is a number given to 3 decimal places, from 0.000 on the left to 1.000 on the right of the whole gradient. *RGB*, *HSV*, *Intensity* and *Opacity* are also a ratio...

If you click-n-drag on display, then only position and RGB data are displayed. But they are passed on to the Foreground color in the Toolbox and to the four first gradients of the list (by pressing the **Ctrl** key, the Color is sent to the Background color of the Toolbox).

Range Selection/Control Sliders Below the gradient display, you see a set of black and white triangles lined up in row which allow you to adjust endpoints and midpoints in the gradient preview. A *segment* is the space between two consecutive *black* triangles. Inside each segment is a white triangle,






which is used to “warp” the colors in the segment, in the same way that the middle slider in the Levels tool warps the colors there. You can select a segment by clicking between the two black triangles that define it. It turns from white to blue. You can select a range of segments by shift-clicking on them. The selected range always consists of a set of *consecutive* segments, so if you skip over any when shift-clicking, they will be included automatically. If “Instant update” is checked, the display is updated immediately after any slider movement; if it is unchecked, updates only occur when you release the mouse button.

You can move sliders, segments and selections. If you simply *click-n-drag a slider*, you only move the corresponding transition. By *click-n-drag on a segment* you can move this segment up to the next triangle. By *Shift+click-n-drag on a segment/selection*, you can move this segment/selection and compress/ dilate next segments.

Scrollbar Below the sliders is a scrollbar. This only comes into play if you zoom in using the buttons at the bottom.

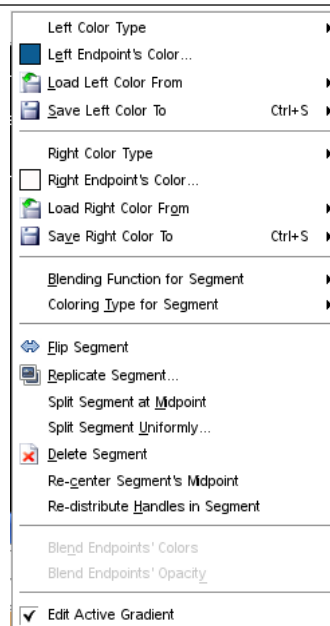
Feedback Area Below, a color swatch shows the color pointed by the mouse cursor. Information about this color and helpful hints or feedback messages may appear here.

Buttons At the bottom of the dialog appear five buttons:

-  **Save** Clicking this button causes the gradient, in its current state, to be saved in your personal `gradients` folder, so that it will automatically be loaded the next time you start GIMP.
-  **Revert** Clicking this button undoes all of your editing. (However, at the time this is being written, this function is not yet implemented.)
-  **Zoom Out** Clicking this button shrinks the gradient display horizontally.
-  **Zoom In** Clicking this button expands the gradient display horizontally. You can then use the scrollbar to pan the display left or right.
-  **Zoom All** Clicking this button resizes the display horizontally so that it fits precisely into the window.

15.3.4.3.3 The Gradient Editor pop-up Menu

Figure 15.44 The Gradient Editor pop-up menu



You can access the Gradient Editor menu either by right-clicking on the gradient display, or by choosing the top item in the dialog’s tab menu. The menu allows you to edit endpoint’s color (set the left and right edge colors for each segment), blend colors, select a color model and edit segments. This editor works only with custom gradients or a copy of a system gradient.

The following commands can be found in the menu:
 Editing endpoint's color

Left/Right color type This command opens a submenu:


Figure 15.45 The Left/Right color type sub-menu



This submenu allows you to select the endpoint color from the toolbox foreground and background colors. Whenever you change the foreground or background color, this endpoint color may be changed as well. The alternative is to select a Fixed endpoint color.

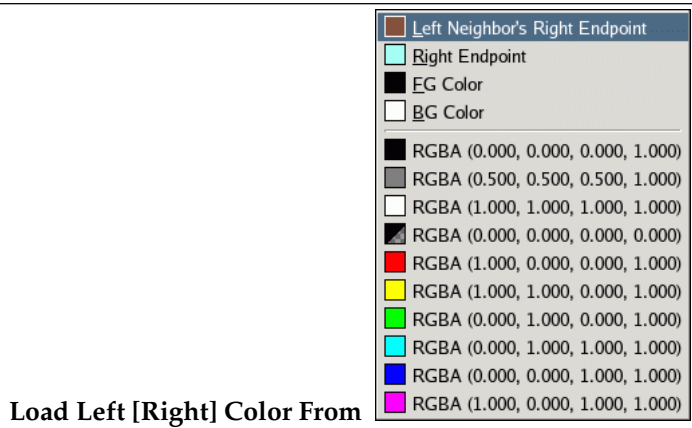
Left [Right] Endpoint's Color These options allow you to choose a color for the respective endpoint using a Color Editor.

Note



This command is related to the previous one and becomes inactive if you have selected any other value than Fixed for the corresponding Left [Right] Color Type.

Figure 15.46 The "Load Color From" submenu



These options give you a number of alternative ways of assigning colors to the endpoints. From the submenu you can choose (assuming we're dealing with the left endpoint):

Left Neighbor's Right Endpoint This choice will cause the color of the right endpoint of the segment neighboring on the left to be assigned to the left endpoint of the selected range.

Right Endpoint This choice will cause the color of the right endpoint of the selected range to be assigned to the left endpoint.

FG/BG color This choice causes GIMP's current foreground or background color, as shown in the Toolbox, to be assigned to the endpoint. Note that changing foreground or background color later will not change the endpoint's color.

RGBA slots At the bottom of the menu are 10 "memory slots". You can assign colors to them using the "Save" menu option described below. If you choose one of the slots, the color in it will be assigned to the endpoint.

Save Left [Right] Color To These options cause the color of the endpoint in question to be assigned to the “memory slot” selected from the submenu.

Click and drag colors You can also click and drag a color from the toolbox FG-BG colors or from a palette

- to an endpoint (a black triangle), to set left [right] colors,
- to the gradient display area, to add a new endpoint with this color on both sides.

Blending and coloring functions for segment

Figure 15.47 The Blending Function submenu



This option determines the course of the transition from one endpoint of the range (segment or selection) to the other, by fitting the specified type of function to the endpoints and midpoint of the range:

Linear Default option. Color varies linearly from one endpoint of the range to the other.

Curved Gradient varies more quickly on ends of the range than on its middle.

Sinusoidal The opposite of the curved type. Gradients varies more quickly on center of the range than on its ends.

Spherical (increasing) Gradient varies more quickly on the left of the range than on its right.

Spherical (decreasing) Gradient varies more quickly on the right than on the left.

Figure 15.48 The Coloring Type submenu



This option gives you additional control of the type of transition from one endpoint to the other: as a line either in RGB space or in HSV space.

Modifying segments

Flip Segment This option does a right-to-left flip of the selected range (segment or selection), flipping all colors and endpoint locations.

Replicate Segment This option splits the selected range (segment or selection) into two parts, each of which is a perfect compressed copy of the original range.

Split Segment at Midpoint This option splits each segment in the selected range in into two segments, splitting at the location of the white triangle.

Split Segment Uniformly This option is similar to the previous one, but it splits each segment halfway between the endpoints, instead of at the white triangle.

Delete Segment This option deletes all segments in the selected range, (segment or selection) replacing them with a single black triangle at the center, and enlarging the segments on both sides to fill the void.

Re-center Segment’s midpoint This option moves the white triangle for each segment in the selected range to a point halfway between the neighboring black triangles.

Re-distribute Handles in Segment This option causes the black and white triangles in the selected range to be shifted so that the distances from one to the next are all equal.

Blending colors

These options are available only if more than one segment are selected.

Blend Endpoints' Colors This option causes the colors at interior endpoints in the range to be averaged, so that the transition from each segment to the next is smooth.

Blend Endpoints' Opacity This option does the same thing as the previous option, but with opacity instead of color.

Caution



There is no "undo" available within the Gradient Editor, so be careful!

15.3.4.3.4 Using example for the Gradient Editor

All these options can seem somewhat boring. Here is an example to clear ideas:


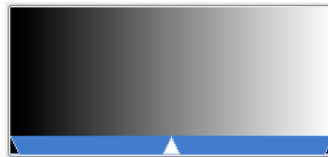
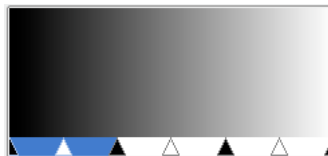
1. Open the Gradient Dialog. Click the New Gradient . The Gradient Editor is opened and shows a gradient from black to white.

Figure 15.49 New gradient



2. Right click in this new gradient and click the Split Segment Uniformly. Fix the number of segments you want.

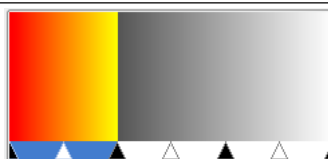
Figure 15.50 Gradient with three segments



*Every segment is limited with two black triangular sliders. Click a segment to activate it. By pressing the **Shift** key, you can select several contiguous segments.*

3. In the context menu you get by right-clicking in the gradient, set Left Endpoint Color and Right Endpoint Color for the selected segment or segment group.

Figure 15.51 First segment colored



Red has been chosen for left endpoint and yellow for the right endpoint.

4. Go on the same way for other segments. Then use the Blending functions for segment to achieve various effects.

15.3.5 Palettes Dialog

A *palette* is a set of discrete colors, in no particular order. See the [Palettes](#) section for basic information on palettes and how they can be created and used.

The “Palettes” dialog is used to select a palette, by clicking on it in a list or grid view. A few dozen more or less randomly chosen palettes are supplied with GIMP, and you can easily add new palettes of your own. The “Palettes” dialog also give you access to several operations for creating new palettes or manipulating the ones that already exist.


Note



The “Palettes” dialog is not the same thing as the [Index Palette dialog](#), which is used to manipulate the colormaps of indexed images.

15.3.5.1 Activating the dialog

The “Palettes” dialog is a dockable dialog; see the section [Section 3.2.3](#) for help on manipulating it. You can access it:

- from the image menu: Windows → Dockable Dialogs → Palettes;
- from the Tab menu in any dockable dialog by clicking on  and selecting Add Tab → Palettes.

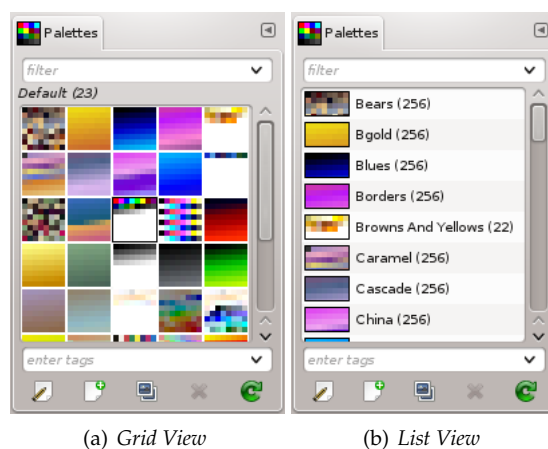
15.3.5.2 Using the Palettes dialog

Clicking on a palette in the dialog selects this palette and brings up the [Palette Editor](#), which allows you to set GIMP’s foreground or background colors by clicking on colors in the palette display. You can also use the arrow keys to select a palette.

Double-clicking on a palette *name* (in List View mode) lets you to edit the name. Note that you are only allowed to change the names of palettes that you have added yourself, not those that are supplied with GIMP. If you edit a name that you are not allowed to change, it will revert back to its previous value as soon as you hit return or move the pointer focus elsewhere.

Grid/List modes

Figure 15.52 The “Palettes” dialog



In the Tab menu, you can choose between View as Grid and View as List. In Grid mode, the palettes are laid out in a spectacular rectangular array, making it easy to see many at once and find the one you are looking for. In List mode (the default), the palettes are lined up in a list, with the names beside them.

The option Preview Size allows you to adapt the size of color cell previews to your liking.

Tagging You can use tags to reorganize the palettes display. See Section 15.3.6.

The buttons of the Palettes Dialog

Below the palettes view, at the bottom of the dialog window, there are several buttons:



Edit Palette This button brings up the Section 15.3.5.4.



New Palette For more information on this button please refer to [New Palette](#).



Duplicate Palette For more information on this button please refer to [Duplicate Palette](#).



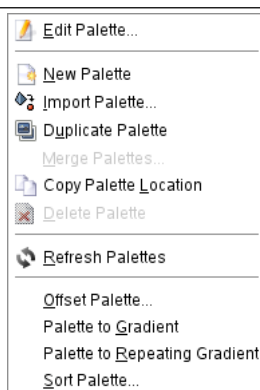
Delete Palette For more information on this button please refer to [Delete Palette](#).



Refresh Palettes For more information on this button please refer to [Refresh Palettes](#).

15.3.5.3 The “Palettes” pop-menu

Figure 15.53 The “Palettes” pop-menu



The “Palettes” pop-menu can be accessed by right-clicking in the Palettes dialog, or by choosing the top item from the dialog Tab menu ().

Note



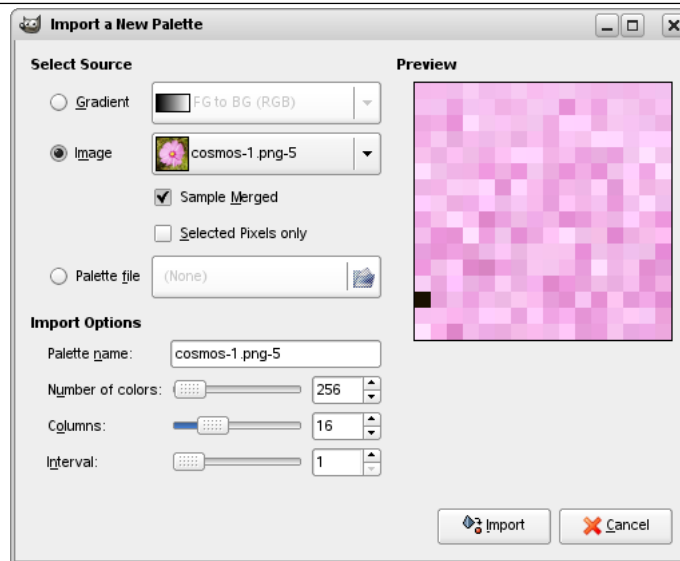
Some of the listed pop-menu entries are installation-dependent and need the [Python language interpreter](#) to be installed. This includes at the time of writing: [Offset Palette...](#), [Palette to gradient](#), [Palette to Repeating Gradient](#) and [Sort Palette...](#)

Edit Palette “Edit Palette” is an alternative way of activating the [Palette Editor](#): it can also be activated by double-clicking on a palette in the Palettes dialog, or by pressing the “Edit Palette” button at the bottom of the dialog.

New Palette “New Palette” creates a new, untitled palette, initially containing no color entries, and pops up the Palette Editor so that you can add colors to the palette. The result will automatically be saved in your personal `palettes` folder when you quit GIMP, so it will be available from the Palettes dialog in future sessions.

Import Palette

Figure 15.54 The Import Palette dialog



“Import Palette” allows you to create a new palette from the colors in a gradient, an image or a palette file. Choosing it brings up the “Import Palette” dialog, which gives you the following options:

Note



Former versions of GIMP had a “Save palette” command. It no longer exists. To save the palette of an image, indexed or not, you must *import* it in fact from the image.

Select Source You can import a palette either from any of GIMP’s gradients (choosing one from the adjoining menu), or from any of the currently open images (chosen from the adjoining menu). Since GIMP 2.2, you can also import a RIFF palette file (with extension `.pal`), of the type used by several Microsoft Windows applications.

Two options concerning image as source, available for RGB images only:

- **Sample merged:** When this option is checked, colors are picked from all visible layers. If unchecked, pixels are picked from the active layer only, even though not visible.
- **Selected pixels only:** As the name says, pixels are picked from the selected area only, in the active layer or all visible layers according to the status of the previous option.

Palette name You can give a name to the new palette here. If the name you choose is already used by an existing palette, a unique name will be formed by appending a number (e. g., “#1”).

Number of colors Here you specify the number of colors in the palette. The default is 256, chosen for three reasons: (1) every gradient contains 256 distinct colors; (2) GIF files can use a maximum of 256 colors; (3) GIMP indexed images can contain a maximum of 256 distinct colors. You can use any number you like here, though: GIMP will try to create a palette by spacing the specified number of colors even across the color range of the gradient or image.

Columns Here you specify the number of columns for the palette. This only affects the way the palette is displayed, and has no effect on the way the palette is used.

Interval Even setting “Number of colors” to maximum, the number of colors can’t exceed 10000 in the palette. RGB images have much more colors. Interval should allow to group similar colors around an average and so get a better palette. This problem doesn’t exist with 256 colors indexed images: Interval to 1 allows picking 256 colors (this option is grayed out with more than 256 colors indexed palettes too).

The imported palette will be added to the Palettes dialog, and automatically saved in your personal palettes folder when you quit GIMP, so it will be available in future sessions.

Duplicate Palette Duplicate Palette creates a new palette by copying the palette that is currently selected, and brings up a Palette Editor so that you can alter the palette. The result will automatically be saved in your personal palettes folder when you quit GIMP, so it will be available from the Palettes dialog in future sessions.

Merge Palettes Currently this operation is not implemented, and the menu entry will always be insensitive.

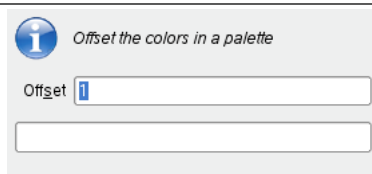
Copy Palette Location This command allows you to copy the palette file location to clipboard. You can then paste it in a text editor.

Delete Palette Delete Palette removes the palette from the “Palettes” dialog, and deletes the disk file in which it is stored. Before it acts, it asks you confirm that you really want to do these things. Note that you cannot remove any of the palettes that are supplied with GIMP, only palettes you have added yourself.

Refresh Palettes Refresh Palettes rescans all of the folders in your palette search path, and adds any newly discovered palettes to the list in the Palettes dialog. This may be useful if you obtain palette files from some external source, copy them into one of your palettes folders, and want to make them available during the current session.

Offset Palette... This command opens a dialog window:

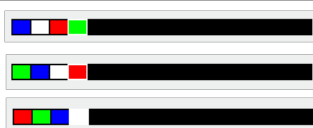
Figure 15.55 The “Offset Palette” dialog



This command takes the last color of the palette and puts it at the first place. The Offset parameter lets you set how many times this action must be performed.

With negative “Offsets” colors are put from the first position to the end of the colors list.

Figure 15.56 “Offset Palette” examples



From top to bottom: original palette, Offset = 1, Offset = 2.

Palette to gradient With this command, all the colors of the palette are used to form the current gradient which is saved in the Gradient Dialog. The created gradient is build with segments just as much as the number of colors on the given palette.

Palette to Repeating Gradient This command creates a repeating gradient, using all the colors of the palette. This gradient appears in the Gradient Dialog and becomes the current gradient. The gradient is created with segments one more than the number of colors on the given palette. The left side color at the leftmost segment will be the same color on the right side at the rightmost segment.

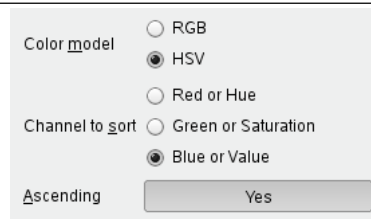
Figure 15.57 “Palette to repeating gradient” examples



Top: palette. Bottom: the gradient created with the command.

Sort Palette... This command opens a dialog window which allows you to sort the colors of the palette according to certain criterions:

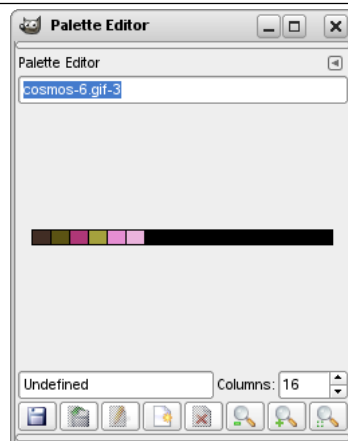
Figure 15.58 The “Sort Palette” dialog



- Color model: you can choose between *RGB* and *HSV*
- Channel to sort: you can choose between the three RGB channels if the RGB model is selected, or the three HSV channels if the HSV channel is selected.
- Ascending (default is Yes): values are sorted from the lower to the upper. By clicking on this Yes you can toggle to No and values will be sorted in descending order.


15.3.5.4 Palette Editor

Figure 15.59 The Palette Editor



The Palette Editor is used mainly for two purposes: first, for setting GIMP’s foreground or background colors (as shown in the Color Area of the Toolbox) to selected colors from the palette; second, for modifying the palette. You can activate the Palette Editor for any palette in the Palettes dialog, but you can only modify palettes that you have created yourself, not the palettes that are supplied when you install GIMP. (You can, however, duplicate any palette and then edit the newly created copy.) If you modify a palette, the results of your work will automatically be saved when you exit from GIMP.

15.3.5.4.1 How to Activate the Palette Editor

The Palette Editor is only accessible from the Palettes dialog: you can activate it by double-clicking on a palette, or by pressing the  “Edit Palette” button at the bottom, or by choosing “Edit Palette” from the “Palettes” Menu.

The Palette Editor is a dockable dialog; see the section on [Dialogs and Docking](#) for help on manipulating it.

15.3.5.4.2 Using the Palette Editor

If you click on a color box in the palette display, GIMP’s foreground color will be set to the selected color: you can see this in the Color Area of the Toolbox. If you hold down the **Ctrl** key while clicking, GIMP’s background color will be set to the selected color.


If the palette is a custom palette, double-clicking on a color not only sets the foreground, it also brings up a color editor that allows you to modify the selected palette entry.

Right-clicking in the palette display area brings up the Palette Editor menu. It's functions are mainly the same as those of the buttons at the bottom of the dialog.


Below the palette display area, at the left, appears a text entry area that shows the name of the selected color (or "Untitled " if it does not have one). This information has no functional significance, and is present only to serve you as a memory aid.


To the right of the name entry is a spinbutton that allows you to set the number of columns used to display the palette. This only affects the display, not how the palette works. If the value is set to 0, a default will be used.


At the bottom of the dialog are a set of buttons, which mostly match the entries in the Palette Editor menu, accessible by right-clicking in the palette display area. Here are the buttons:


 **Save** This button causes the palette to be saved in your personal `palettes` folder. It would be saved automatically when GIMP exits in any case, but you might want to use this button if you are concerned that GIMP might crash in the meantime.


 **Revert** This operation has not yet been implemented.


 **Edit Color** Pops up a color editor allowing you to alter the color. If the palette is one you aren't allowed to alter, this button will be insensitive. See [below](#)

 **New Color from FG** For more information on this button please refer to [below](#).

 **Delete Color** For more information on this button please refer to [below](#).

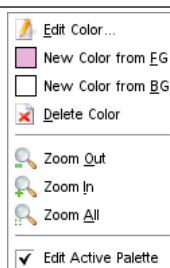
 **Zoom Out** For more information on this button please refer to [below](#).

 **Zoom In** For more information on this button please refer to [below](#).

 **Zoom All** For more information on this button please refer to [below](#).

15.3.5.5 The Palette Editor pop-menu

Figure 15.60 The Palette Editor pop-menu



The Palette Editor Menu can be accessed by right-clicking on the palette display in the Palette Editor, or by choosing the top entry from the dialog Tab menu. The operations in it can also be executed using the buttons at the bottom of the Palette Editor dialog.

Edit Color "Edit Color" brings up a color editor that allows you to modify the color of the selected palette entry. If the palette is one that you are not allowed to edit (that is, one supplied by GIMP when it is installed), then the menu entry will be insensitive.

New Color from FG; New Color from BG These commands each create a new palette entry, using either GIMP's current foreground color (as shown in the Color Area of the Toolbox), or the current background color.

Delete Color "Delete Color" removes the selected color entry from the palette. If the palette is one that you are not allowed to edit, then the menu entry will be insensitive.

Zoom Out "Zoom Out" reduces the vertical scale of the entries in the palette display.

Zoom In “Zoom In” increases the vertical scale of the entries in the palette display.

Zoom All “Zoom All” adjusts the vertical size of the entries in the palette display so that the entire palette fits into the display area.

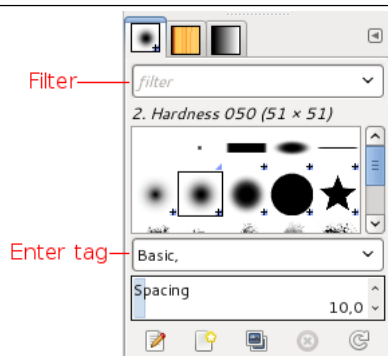
Edit Active Palette When this option is checked (default), you can edit another palette by clicking on it in the “Palettes” dialog.

15.3.6 Tagging

In Brushes, Gradients, Patterns and Palettes dialogs and some other dockable dialogs, you can define tags and then, you can reorganize items according to chosen tags only.

You have two input fields:

Figure 15.61 Tagging

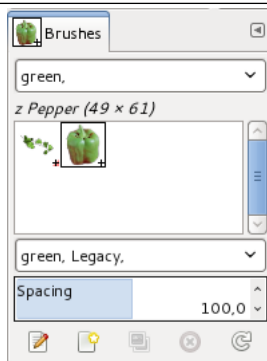


- “Filter” field: There, you can enter a tag previously defined or select a tag in the pop list you get by clicking on the arrow head at the right end of the field. Brushes, gradients, patterns, or palettes are filtered and only these that have this chosen tag will be displayed. You can enter several tags, separated with commas.
- “Enter tag” field: There, tags belonging to the current brush, gradient, pattern, or palette are displayed. You can add another tag to the current item by clicking on one of the defined tag in the pop up list of the field. You can also create your own tag for this item by typing its name in the field. Then the new tag appears in the tag pop up list.

Note



Since GIMP-2.10.4, the Fonts dialog also has Filter and Enter tag fields. But GIMP doesn't yet automatically generate any tags from fonts metadata.

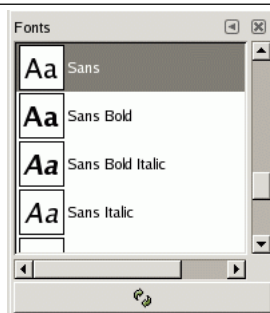
Figure 15.62 Example

In this example, we defined a “green” tag for the Pepper and Vine brushes. Then, we entered “green” in the Filter input field and so, only brushes with the green tag are displayed.

Tip

To give several brushes the same tag at once, display brushes in List Mode, and use Ctrl-Mouse Left Button on the brushes you want to select.

You can delete tags: select a brush, then select a tag in the “Enter tag” field and press the **Delete** key. When this tag has been removed from all brushes, it disappears from the list.


15.3.7 Fonts Dialog**Figure 15.63** The Fonts dialog

The “Fonts” dialog is used for selecting fonts for the **Text tool**. It also allows you to refresh the list of available fonts, if you add new ones to your system while GIMP is running.

15.3.7.1 Activating the Dialog

The “Fonts” dialog is a dockable dialog; see the section Section 3.2.3 for help on manipulating it.

You can access it:

- from an image menu: Windows → Dockable Dialogs → Fonts;
- from the Tab menu in any dockable dialog by clicking on  and selecting Add Tab → Fonts,
- from the Tool Options for the Text tool. If you click on the “Font” button, a Font-selector pops up. In the lower right corner is a button that, if pressed, brings up the “Fonts” dialog.

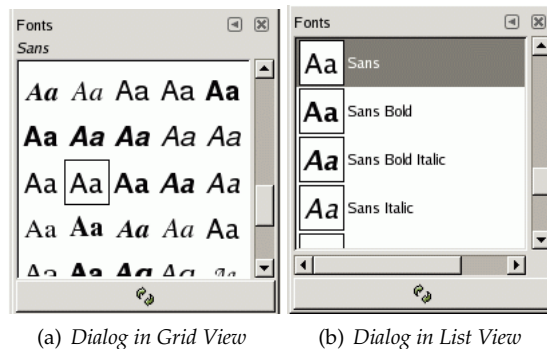
In the Windows menu, there is a list of **detached windows** which exists only if at least one dialog remains open. In this case, you can raise the “Fonts” dialog from the image-menu: Windows → Fonts.

15.3.7.2 Using the Fonts dialog

The most basic thing you can do is to select a font by clicking on it: this font will then be used by the Text tool. If instead of clicking and releasing, you hold down the left mouse button with the pointer positioned over the font example (“Aa”), a window showing a larger text example will pop up (“Pack my box with five dozen liquor jugs”).

Grid/List modes

Figure 15.64 The Fonts dialog



Tip



Ctrl-F opens a search field. See [View as List](#); [View as Grid](#)

In the Tab menu for the Fonts dialog, you can choose between View as Grid and View as List. In Grid mode, the fonts are laid out in a rectangular array. In List mode, they are lined up vertically, with each row showing an example of the appearance of the font (“Aa”), followed by the name of the font.

 **Refresh font list** Pressing this button at the bottom of the dialog causes the system font list to be rescanned. This may be useful if you add new fonts while GIMP is running, and want to make them accessible for the Text tool. You can also cause the font list to be rescanned by right-clicking in the font display, and selecting “Rescan Font List” from the menu that pops up (it is actually the only option in the menu).

Tip

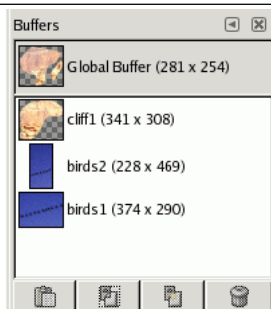


You can change the size of the font previews in the dialog using the “Preview Size” submenu of the dialog’s Tab menu.

15.4 Image Management Related Dialogs

15.4.1 Buffers Dialog

Figure 15.65 The Buffers dialog (as a list)



Buffers are temporary repositories for image data, created when you cut or copy part of a drawable (a layer, layer mask, etc.). You can save a document in this buffer in two ways: Edit → Buffer → Copy Named or Edit → Buffer → Cut Named. A dialog pops up asking you to name a buffer to store the data in. There is no hard limit on the number of named buffers you can create, although, of course, each one consumes a share of memory.

The “Buffers” dialog shows you the contents of all existing named buffers, and allows you to operate on them in several ways. It also shows you, at the top, the contents of the Global Buffer, but this is merely a display: you can’t do anything with it.

Caution




Named buffers are not saved across sessions. The only way to save their contents is to paste them into images.

15.4.1.1 Activating the Dialog

This dialog is a dockable dialog; see the section Section 3.2.3 for help on manipulating it.

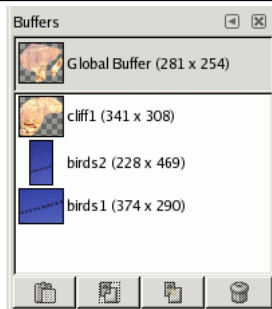
You can access it:

- from an image menu: Windows → Dockable Dialogs → Buffers;
- from the Tab menu in any dockable dialog by clicking on  and selecting Add Tab → Buffers.

In the Windows menu, there is a list of **detached windows** which exists only if at least one dialog remains open. In this case, you can raise the “Buffers” dialog from the image-menu: Windows → Buffers.

15.4.1.2 Using the Buffers dialog

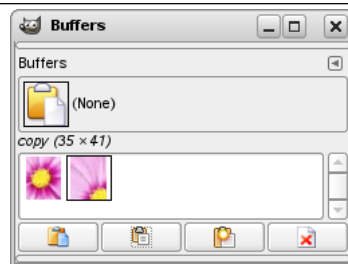
Figure 15.66 The Buffers Menu



Clicking on a buffer in the display area makes it the active buffer, i. e., the one that will be used for paste commands executed with the Buffers Menu or the buttons at the bottom of the dialog. Double-clicking on a buffer causes its contents to be pasted to the active image as a floating selection; this is a quick way of executing the “Paste Buffer” command.

At the bottom of the dialog are four buttons. The operations they perform can also be accessed from the Buffers Menu that you get by right clicking on the active buffer.

Figure 15.67 The Buffers dialog (Grid View)



In the Tab menu for the “Buffers” dialog, you can choose between View as Grid and View as List. In Grid mode, the buffers are laid out in a rectangular array. In List mode, they are lined up vertically, with each row showing a thumbnail of the contents of the buffer, its name, and its pixel dimensions.

Tip



Ctrl-F opens a search field. See [View as List](#); [View as Grid](#)

You can change the size of the buffer previews in the dialog using the “Preview Size” submenu of the dialog’s Tab menu.

15.4.1.2.1 Buttons at the bottom

At the bottom of the dialog you find a couple of buttons:

Paste Buffer This command pastes the contents of the selected buffer into the active image, as a floating selection. The only difference between this and the ordinary [Paste](#) command is that it uses the selected buffer rather than the global clipboard buffer.

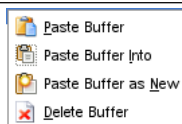
Paste Buffer Into This command pastes the contents of the selected buffer into the active image’s selection, as a floating selection. The only difference between this and the ordinary [Paste Into Selection](#) command is that it uses the selected buffer rather than the global clipboard buffer.

Paste Buffer as New This command creates a new single-layer image out of the contents of the selected buffer. The only difference between this and the ordinary **Paste as New Image** command is that it uses the selected buffer rather than the content of the global clipboard buffer.

Delete Buffer This command deletes the selected named buffer, no questions asked. You cannot delete the Global Buffer.

15.4.1.2.2 Context menu

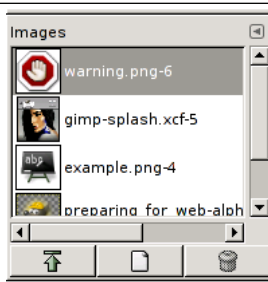
Figure 15.68 The “Buffers” context menu



These commands are explained above with Buttons.

15.4.2 Images Dialog

Figure 15.69 The Images dialog




The “Images” Dialog displays the list of open images on your screen; each of them is represented with a thumbnail. This dialog is useful when you have many overlapping images on your screen: thus, you can raise the wanted image to foreground.

15.4.2.1 Activating the dialog

The “Images” dialog is a dockable dialog; see the section Section 3.2.3 for help on manipulating it.

You can access it:

- from the image menu: Windows → Dockable Dialogs → Images;
- from the Tab menu in any dockable dialog by clicking on  and selecting Add Tab → Images.

In the Windows menu, there is a list of **detached windows** which exists only if at least one dialog remains open. In this case, you can raise the “Images” dialog from the image-menu: Windows → Images.

15.4.2.2 Using the Images dialog

In multi-window mode, at the top of the dialog, a drop-list of open images appears if the “Show Image Selection” option is checked in the Tab Menu.

At center, open images appear, as a list or a grid, according to the selected mode. The current image is highlighted in list mode, outlined in grid mode. With a double click on an image name, you raise this image to the foreground of your screen. With a simple click you select this image so that the buttons of the dialog can act on it.

Grid and List modes, preview size In the Tab menu for the “Images” dialog, you can choose between View as Grid and View as List. In Grid mode, the images are laid out in a rectangular array. In List mode, they are lined up vertically, with each row showing a thumbnail of the contents of the image, its name, and its pixel dimensions.

Tip



Ctrl-F opens a search field. See [View as List](#); [View as Grid](#)

You can change the size of the image previews in the dialog using the “Preview Size” submenu of the dialog’s Tab menu.

Buttons Three buttons at the bottom of the dialog allow you to operate on the selected image. These buttons are present if the “Show button bar” is checked in the tab dialog. You can get the same commands through the pop menu by right-clicking on the dialog.

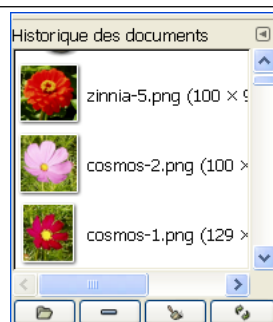
Raise this image displays The selected image appears at the foreground of your screen. If this image has another view, this view also is raised but remains behind the original. The same option in the pop-up menu, that you get by right-clicking, is called “Raise views ”

Create a new display for this image Duplicates the image window (not the image) of the selected image.

Delete This command works only on a image which is loaded without any window. Though images can be opened by the New Window command, if the image has been already loaded without window by a primitive procedure command (such as `gimp-image-new`, `file-png-load`, etc.), it can not be unloaded even if its windows are closed to the last. Then use this command to close it.

15.4.3 Document History Dialog

Figure 15.70 Document History dialog




The History Dialog displays the list of the documents you have opened in previous sessions. It is more complete than the list you get with the “Open Recent” command.

15.4.3.1 Activating the Dialog

The “History” dialog is a dockable dialog; see the section Section 3.2.3 for help on manipulating it.

You can access it:

- From an image menu: Windows → Dockable Dialogs → Document History.
- From the Tab menu in any dockable dialog by clicking on  and selecting Add Tab → Document History.
- From the image Menu bar through: File → Open Recent → Document History.

15.4.3.2 Using the Document History dialog


The scroll bar allows you to browse all images you have opened before.


In the Tab menu for the “Document History” dialog, you can choose between View as Grid and View as List. In Grid mode, the documents are laid out in a rectangular array. In List mode, they are lined up vertically, with each row showing a thumbnail of the contents of the image, its name, and its pixel dimensions.


Tip




Ctrl-F opens a search field. See [View as List](#); [View as Grid](#)

Use the *Open the selected entry*  button or Open Image command of the dialog’s context menu, to open the image you have selected. With the **Shift** key pressed, it raises an image hidden behind others. With the **Ctrl** key pressed, it opens the Open Image dialog.

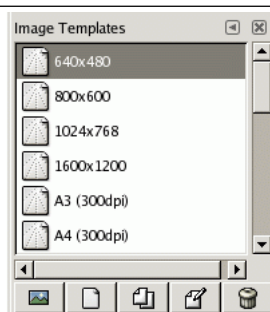
Use the *Remove the selected entry*  button or Remove Entry command of the dialog’s context menu, to remove an image from the History dialog. The image is removed from the recently open images list also. But the image itself is not deleted.

Use the *Clear the entire file history*  button or Clear History command of the dialog’s context menu, to remove all the files from the history.

Use the *Recreate Preview*  button or Recreate Preview command of the dialog’s context menu, to update preview in case of change. With **Shift** key pressed, it acts on all previews. With **Ctrl** key pressed, previews that correspond to files that can’t be found out, are deleted.

15.4.4 Templates Dialog

Figure 15.71 The Templates dialog




Templates are templates for an image format to be created. GIMP offers you a lot of templates and you can create your owns. When you create a New image, you can access to the list of existing templates but you can’t manage them. The “Templates” dialog allows you to manage all these templates.

15.4.4.1 Activating the dialog

The “Templates” dialog is a dockable dialog; see the section Section 3.2.3 for help on manipulating it.

You can access it:

- from the image menu: Windows → Dockable Dialogs → Templates.
- from the Tab menu in any dockable dialog by clicking on  and selecting Add Tab → Templates.

15.4.4.2 Using the Templates dialog

You select a template by clicking on its icon. Right clicking reveals a local menu that offers the same functions as buttons.

15.4.4.2.1 Grid/List modes

In the Tab menu for the “Templates” dialog, you can choose between View as Grid and View as List. In Grid mode, templates are laid out in a rectangular array of identical icons (unless you gave them a particular icon, as we will see later). Only the name of the selected template is displayed. In List mode, they are lined up vertically; icons are identical too; all names are displayed.

In this Tab menu, the Preview Size option allows you to change the size of thumbnails.


Tip





Ctrl-F in a list view opens a search field. See [View as List](#); [View as Grid](#)

15.4.4.2.2 Buttons at the bottom

The buttons at the bottom of the dialog allow you to operate on templates in several ways:

 **Create a new image from the selected template** Clicking on this button opens the dialog [Create a new image](#) on the model of the selected template.

 **Create a new template** Clicking on this button opens the [New template](#) dialog, identical to the Edit Template dialog, that we will see below.

 **Duplicate the selected template** Clicking on this button opens the Edit Template dialog that we are going to study now.



Edit the selected template Clicking on this button opens the [Edit Template](#) dialog.

Delete the selected template Guess what?

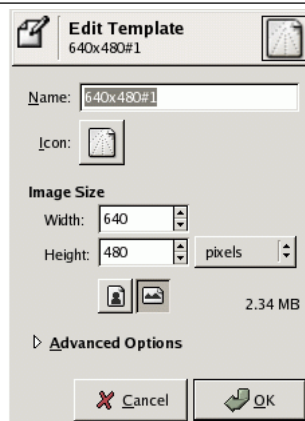
Tip



Every template is stored in a `templaterc` file at your personal GIMP directory. If you want to restore some deleted templates, you can copy or append template entries to your file from the master `templaterc` file at the `etc/gimp/2.0` directory of the GIMP's system folder.

15.4.4.3 Edit Template

Figure 15.72 The Edit Template dialog



The dialog allows you to set the specifications of the selected template.

You can access this editor by clicking on the Edit Template button at the bottom of the dialog.

Options

Name In this text box, you can modify the displayed template name.

Icon By clicking on this icon, you open a list of icons. You can choose one of them to illustrate the selected template name.

Image size Here you set the width and height of the new image. The default units are pixels, but you can switch to some other unit if you prefer, using the adjoining menu. If you do, note that the resulting pixel size will be determined by the X and Y resolution (which you can change in the Advanced Options), and by the setting of “Dot for Dot”, which you can change in the View menu.

Note

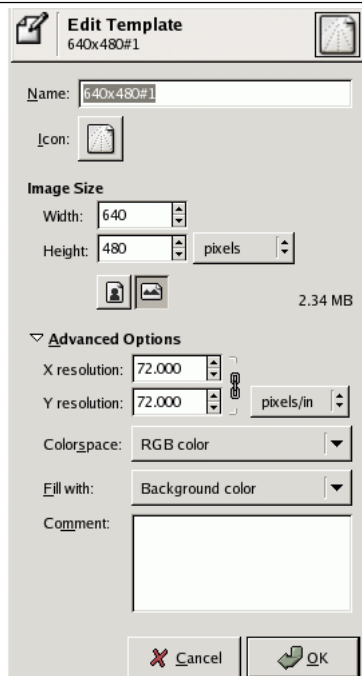


Please keep in mind, that every Pixel of an image is stored in the memory. If you're creating large files with a high density of pixels, GIMP will need some time for every function you're applying to the image.

Portrait/Landscape buttons These buttons toggle between Portrait and Landscape mode. Concretely, their effect is to exchange the values for Width and Height. If the X and Y resolutions are different (in Advanced Options), then these values are exchanged also. On the right, image size, image resolution and color space are displayed.

Advanced Options

Figure 15.73 The “Advanced Options” dialog



These are options that will mainly be of interest to more advanced users.

X and Y resolution These values come into play mainly in relation to printing: they do not affect the size of the image in pixels, but they determine its size on paper when printed. They can also affect the way the image is displayed on the monitor: if “Dot for Dot” is switched off in the View menu, then at 100% zoom, GIMP attempts to display the image on the monitor at the correct physical

size, as calculated from the pixel dimensions and the resolution. The display may not be accurate, however, unless the monitor has been calibrated. This can be done either when GIMP is installed, or from the **Display tab** of the Preferences dialog.

Colorspace You can create the new image as either an RGB image or a grayscale image. You cannot create an indexed image directly in this way, but of course nothing prevents you from converting the image to indexed mode after it has been created.

Fill You have four choices for the solid color that will fill the new image’s background layer:

- Foreground color, as shown in the Main Toolbox.
- Background color, as shown in the Main Toolbox.
- White, the more often used.
- Transparent. If this option is chosen, then the Background layer in the new image will be created with an alpha channel; otherwise not.

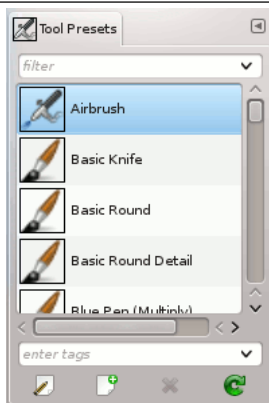
Comment You can write a descriptive comment here. The text will be attached to the image as a “parasite”, and will be saved along with the image by some file formats (but not all of them).

15.5 Miscellaneous Dialogs

15.5.1 Tool Presets Dialog

In GIMP-2.6, tool presets were not easy to use. You had to click on a tool first, and then click on the Restore Presets... button in the button bar at the bottom of the Tool options dialog... if you had not disabled this button bar in the Tab menu to make place on your desk! Now, with GIMP-2.8, a dockable Tool Presets Dialog is available where you just have to click on a preset to open the corresponding tool with its saved options.

Figure 15.74 The Tool Presets Dialog



15.5.1.1 Activating the Dialog

The “Tool Presets Dialog” is a dockable dialog; see the section Section 3.2.3 for help on manipulating it. You can access it:

- from an image menu: Windows → Dockable Dialogs → Tool Presets;
- or, as a tab in Toolbox window, through Tab Menu → Add Tab → Tool Presets.

15.5.1.2 Using the Tool Presets Dialog

This dialog comes with a list of predefined presets. Each of them has an icon representing the tool presets will be applied to and a name.

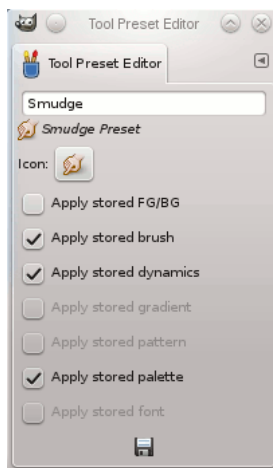
Presets can be tagged so that you can arrange presets display as you want. Please see Section 15.3.6 for more information about tagging.

Double-clicking on a preset icon opens the Tool Preset Editor.

Double-clicking on preset name allows you to edit this name.

At the bottom of the dialog appear four buttons:

- Edit this tool preset: clicking on this button opens the Tool Preset Editor for the selected preset. You can actually edit presets you have created; predefined presets options are all grayed out and inactive. But you can create a new preset from a predefined preset and edit its options.



The Tool Preset Editor is described in Section [15.5.2](#).

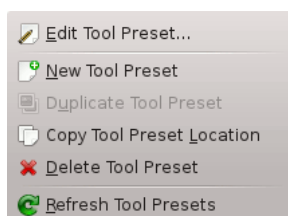
- Create a new tool preset: before clicking on this button, you can either select an existing preset, or select a tool in Toolbox, for example the Healing Tool which is not in the presets list. A new preset is created at the top of the dialog and the Tool Preset Editor is opened. Please see Section [15.5.2](#).
- Delete this tool preset: this button is active only for presets you have created.
- Refresh tool presets: If you have added a preset manually in `gimp/2.0/tool-presets` folder, you have to click on this button to include it in the presets list.

Note



With GIMP-2.8, tool presets are saved in a new format (.gtp). To use your 2.6 presets, you have to convert them using http://wiki.gimp.org/index.php/Mindstorm:Preset_converter, until it is included in GIMP.

15.5.1.3 The Tool Presets Dialog Context Menu

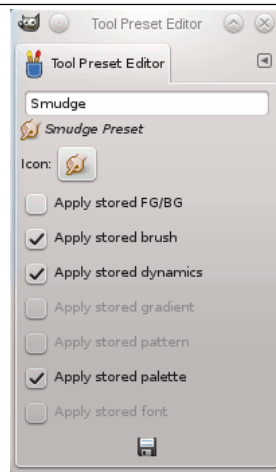


Right-clicking on the Presets Dialog opens a context menu where you find some commands already described with buttons: Edit tool preset, New tool preset, Refresh tool presets. You also find two new commands:

- Duplicate Tool Preset: this command is always disabled. It is not necessary since, as we saw above, a duplicate is automatically created when you create a new preset from an existing preset.
- Copy Tool Preset Location: this command copies the path to the tool preset file into clipboard.

15.5.2 Tool Preset Editor

Figure 15.75 The Tool Preset Editor



15.5.2.1 Activating the Dialog

You can access this dialog through:

- a click on the Edit this tool preset button in the button bar of the Tool Presets Dialog.
- a double-click on a preset icon in the Tool Presets Dialog.
- a right-click on a preset in the Tool Presets Dialog to open a context menu and then click on the Edit Tool Preset command.
- a click on the Save Tool Preset... button from the [Tool Options Dialog](#)

15.5.2.2 Using the Tool Preset Editor

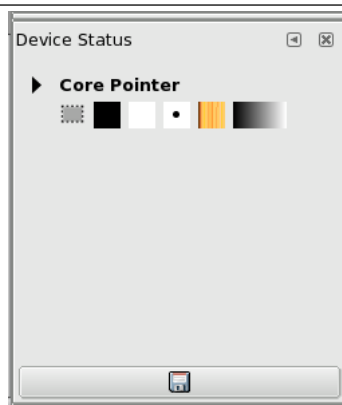
You can edit presets you have created only; all options of predefined presets are disabled. When you save a preset, it is stored in the first writable folder from the folder list set in Edit → Preferences → Folders → Tool Presets.

In this dialog you can:

- **edit preset name** in text box,
- **change preset icon** by clicking on preset icon. This opens a window where you can choose a new icon.
- **select resources to be saved** by clicking on check boxes.

15.5.3 Device Status Dialog

Figure 15.76 The “Device Status” Dialog



This window gathers together the current options of Toolbox, for each of your input devices: the mouse (named “Core pointer”) or either the tablet, if you have one. These options are represented by icons: foreground and background colors, brush, pattern and gradient. Excepted for colors, clicking on an icon opens the window which lets you select another option; the tool-box will be updated when changing. You can drag and drop items to this dialog.

The “Save device status” button  at the bottom of the window, seems to have the same action as the “Record device status now” option in the Input Devices section in preferences.

15.5.3.1 Activating the Dialog

The device status dialog is a dockable dialog; see the section Section 3.2.3 for help on manipulating it. It can be activated in two ways:

- From an image menu : Windows → Dockable Dialogs → Device Status.
- From the Tab menu in any dialog : Add a Dock → Device Status


15.5.4 Error Console

The Error console offers more possibilities than the single “GIMP Message”. This is a log of all errors occurring while GIMP is running. You can save all this log or only a selected part.

15.5.4.1 Activating the Dialog

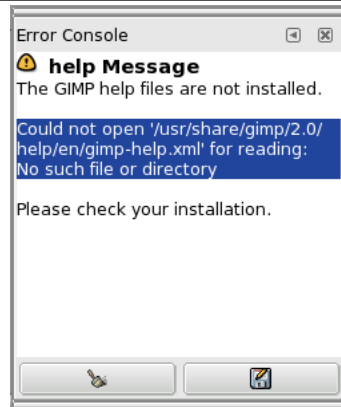
The “Error Console” dialog is a dockable dialog; see the section Section 3.2.3 for help on manipulating it.


You can access it:

- from an image menu: Windows → Dockable Dialogs → Error Console;
- from the Tab menu in any dockable dialog by clicking on  and selecting Add Tab → Error Console.


15.5.4.2 The “Error Console” Dialog

Figure 15.77 “Error Console” Dialog window




 **Clear errors** This button lets you delete all errors in the log.

Warning

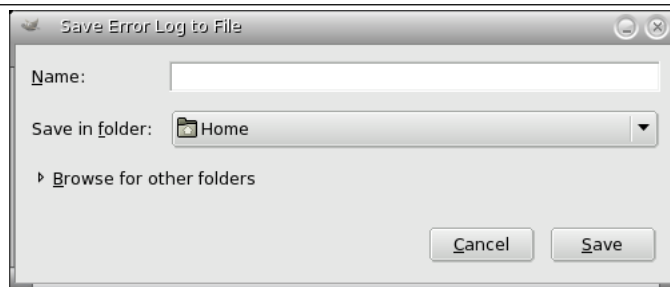


You can't “undo” this action.


 **Save all errors** This button lets you save the whole log. You can also select a part of the log (by click-and-dragging the mouse pointer or by using the Shift-arrow keys key combination) and save only this selected part by pressing the **Shift** key.


A dialog window Save Error Log to File lets you choose the name and the destination directory of this file:

Figure 15.78 “Save Error Log to file” Dialog window



Tip



You will as well find these button actions in the dialog tab menu by clicking on , or in the context menu you get by right-clicking on the dialog window.

15.5.5 Dashboard

This Dashboard helps to monitor GIMP resources (Cache, Swap, CPU, Memory) , allowing you to make more educated decisions about various configuration options. It is also used by developers.

15.5.5.1 Activating the Dialog

The “Dashboard” dialog is a dockable dialog; see the section Section 3.2.3 for help on manipulating it. You can access it:


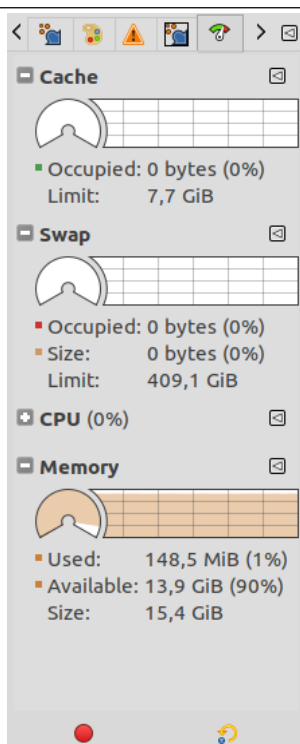
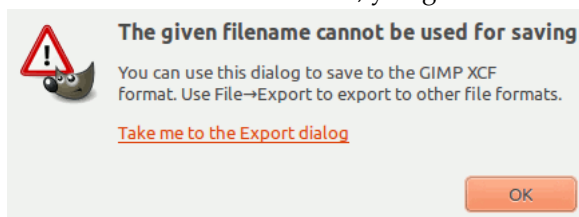
- from an image menu: Windows → Dockable Dialogs → Dashboard;
- from the Tab menu in any dockable dialog by clicking on  and selecting Add Tab → Dashboard.

Figure 15.79 “Dashboard” Dialog window



15.5.6 Save File

The Save command saves your image to disk. With GIMP-2.8 and newer, this command saves in XCF format only. If you try to save to a format other than XCF, you get an error message:

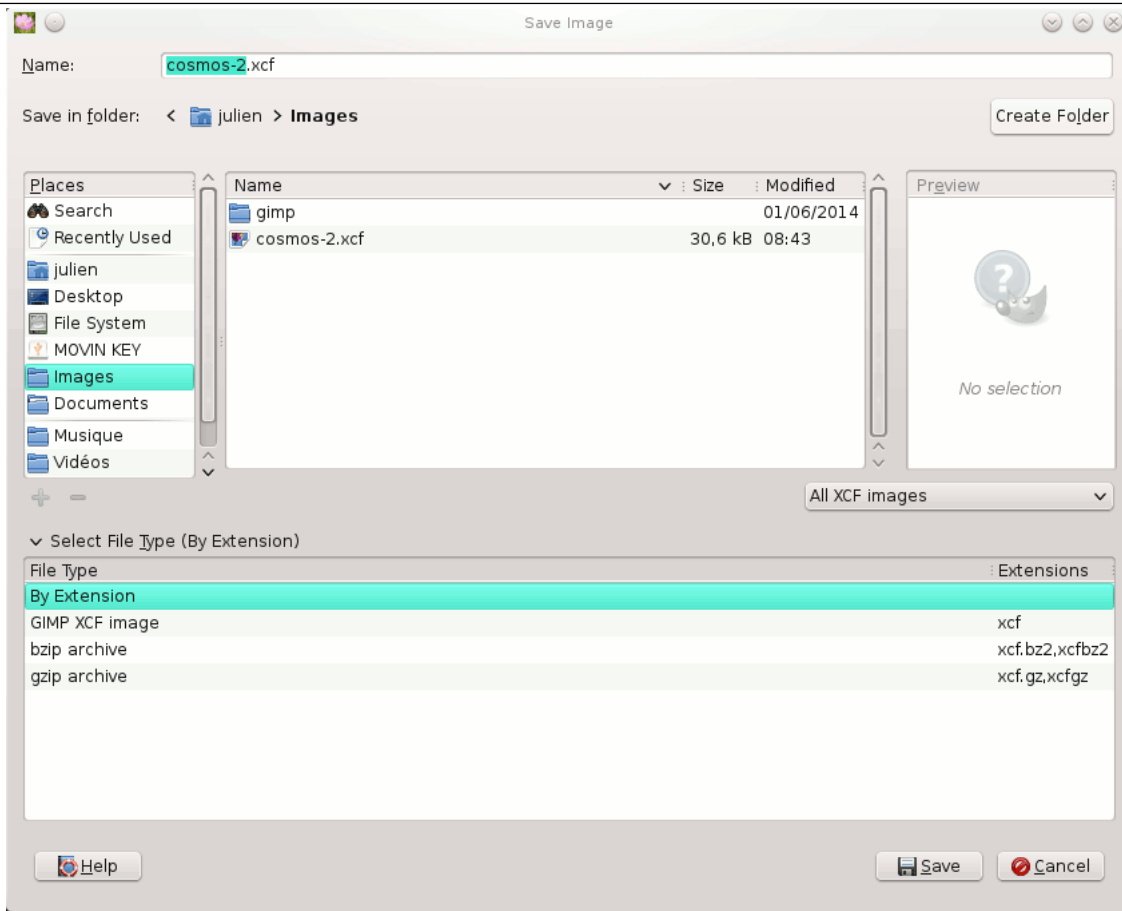


GIMP-2.8.8 and newer displays the Extension Mismatch dialog that contains a link that opens the Export Image dialog. Please see Section 6.1.1.

If you have already saved the image, the previous image file is replaced with the current version. If you have not already saved the image, the Save command opens the Save Image dialog.

If you quit without having saved your image, GIMP asks you if you really want to do so, if the “Confirm closing of unsaved images” option is checked in the **System Resources** page of the Preferences dialog.

Figure 15.80 Save Image Dialog



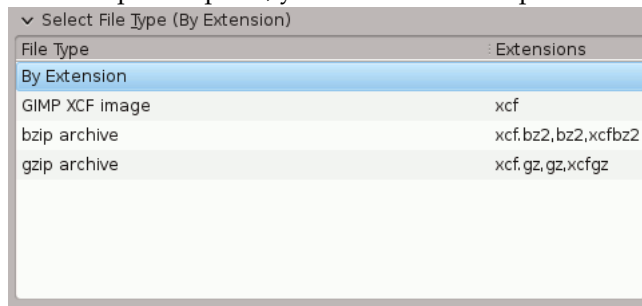
15.5.6.1 Activate the Dialog

- You can access this command in the image menu bar through File → Save,
- or from the keyboard by using the shortcut Ctrl-S.
- Use Ctrl-Shift-S to save the opened image with a different name.

15.5.6.2 The Save Image Dialog

With this file browser, you can edit the filename directly in Name textbox (default is “Untitled.xcf”) or by selecting a file in Name list. We repeat that only XCF format is permitted. You must also fix the image destination in Save in Folder. You can create a new folder if necessary.

Select File Type If you develop this option, you can select a compressed format for your XCF file:

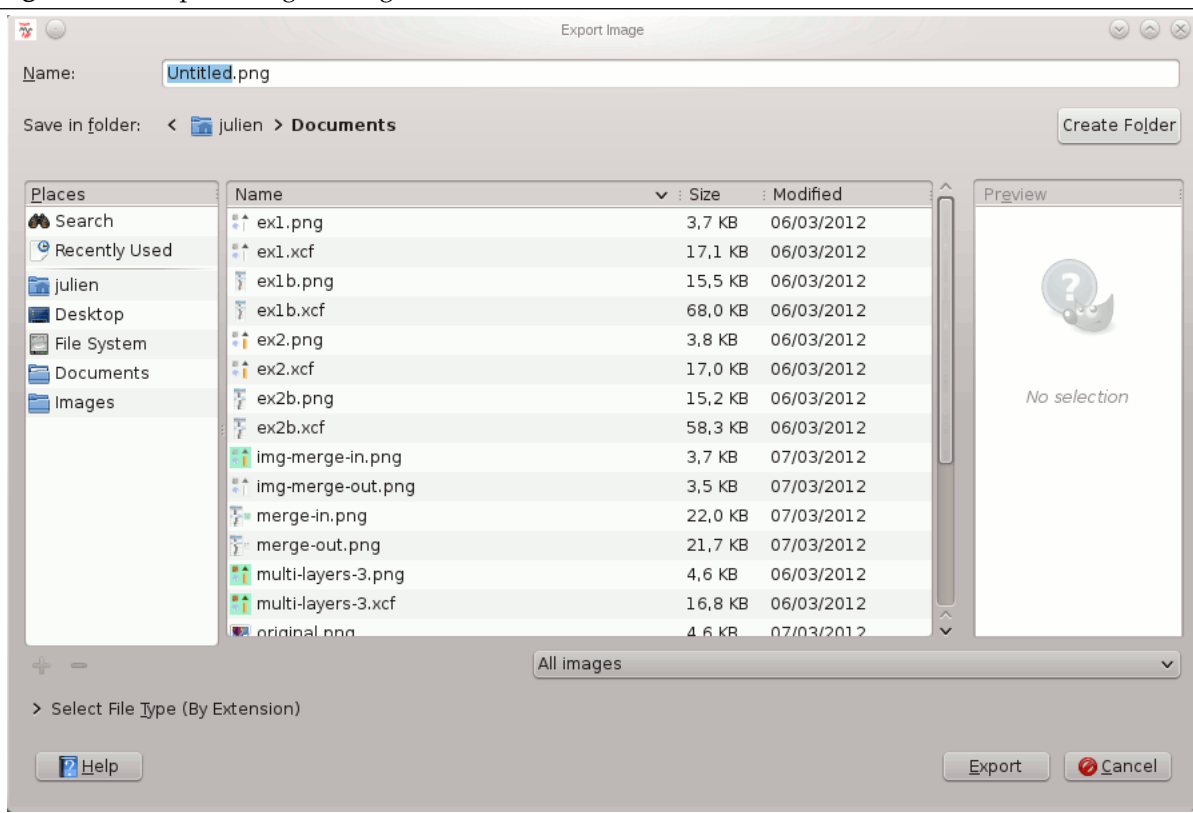


15.5.7 Export File

With GIMP-2.8, the Save command saves images in XCF format only. The Export command is now used to store images to various file formats.

You can access to this command through File → Export As..., or from the keyboard by using the shortcut Ctrl-Shift-E.

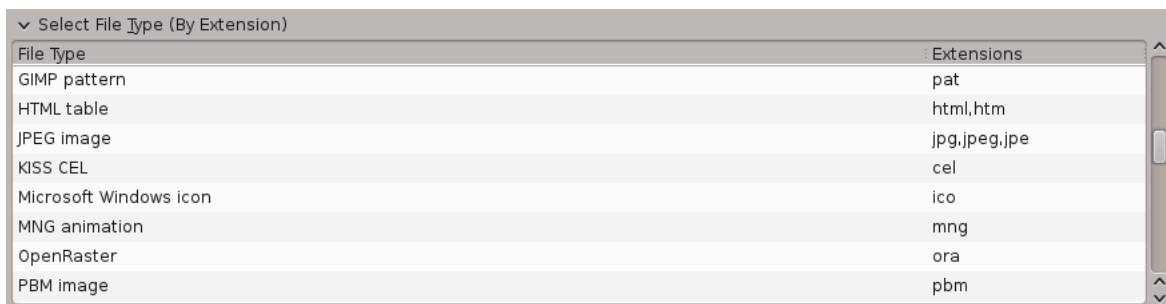
Figure 15.81 Export Image Dialog



15.5.7.1 The Export Image Dialog

With this file browser, you can edit filename and extension directly in name box (default is “Untitled.png”) or by selecting a file in name list. You must also fix the image destination in Save in Folder. You can create a new folder if necessary.

Select File Type If you develop this option, you can select an extension in the drop-down list for your file:



File formats dialogs are described in Section 6.1.

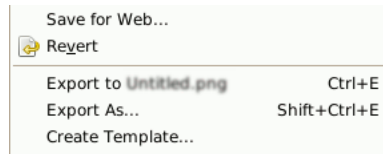
15.5.7.2 Exporting

When file name and destination are set, click on Export. This opens the export dialog for the specified file format.

If you have loaded a non-XCF file, a new item appears in File menu, allowing you to export file in the same format, overwriting the original file.



If you modify an image that you already have exported, the **Export** command in File menu is changed, allowing you to export file again in the same format.




15.5.8 Sample Points Dialog

While the **Color Picker** can display color information about one pixel, the “Sample Points” dialog can display the data of four pixels of the active layer or the image, at the same time. Another important difference is that the values of these points are changed in real time as you are working on the image.

15.5.8.1 Activating the dialog

The “Sample Points” dialog is a dockable dialog; see the section Section 3.2.3 for help on manipulating it.

You can access it:

- from the image menu: Windows → Dockable Dialogs → Sample Points.
- from the Tab menu in any dockable dialog by clicking on  and selecting Add Tab → Sample Points.

15.5.8.2 Using sample points

To create a sample point, **Ctrl**-click on one of the two measure rules of the image window and drag the mouse pointer. Two perpendicular guides appear. The sample point is where both guides intersect. You can see its coordinates in the lower left corner and the information bar of the image window. Release the mouse button.



The reticle you get Ctrl + click-and-dragging from a rule.

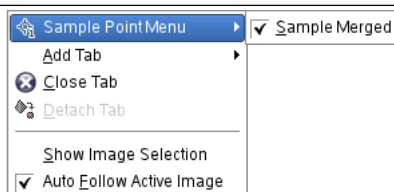
By default, this sample point comes with a round mark and an order number. You can cancel these marks by unchecking the Show Sample Points option in the View menu.

The “Sample Points” dialog should automatically open when you create a sample point. This is not the case; you have to open it manually.

To move or delete a sample point:

- Using the Eye Dropper tool, simply click-and-drag the sample point, up to a ruler to delete it.
- Using a paint tool, **Ctrl** + click-and-drag the sample point, up to a ruler to delete it.

By default, sampling is performed on all layers. If you want to sample on the active layer only, uncheck the Sample merged option in the tab menu:

Figure 15.82 The “Sample Point” menu

15.5.8.3 “Sample Points” dialog description

Figure 15.83 Sample points dialog

The information about four sample points is displayed in this window. You can create more, which will be existing and not shown. To show them, you have to delete displayed points.

The color of the sampled point is displayed in a swatch box.

In the drop-down list, you can choose between:

Pixel This choice displays the *Red*, *Green*, *Blue* and *Alpha* values of the pixel, as numbers between 0 and 255.

RGB This choice displays the *Red*, *Green*, *Blue* and *Alpha* values of the pixel, as percentages. It also shows the hexadecimal value of the pixel’s color.

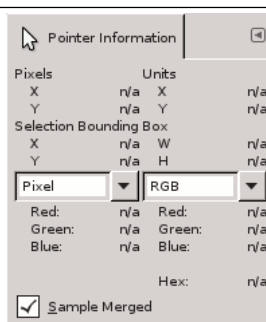
HSV This choice displays the *Hue*, in degrees, as well as the *Saturation*, *Value* and *Alpha* of the pixel, as percentages.

CMYK This choice displays the *Cyan*, *Magenta*, *Yellow*, *Black* and *Alpha* values of the pixel, as percentages.

Data are supplied for every channel in the chosen color model. The Alpha is present only if the image holds an Alpha channel.

Hexa appears only with the RGB mode. That’s the hexadecimal code of the [HTML Notation](#).


15.5.9 Pointer Dialog

Figure 15.84 Pointer dialog

This dialog offers you, in a same window, in real time, the position of the mouse pointer, and the channel values of the pointed pixel, in the chosen color model.

15.5.9.1 Activating the dialog

The “Pointer” dialog is a dockable dialog; see the section Section 3.2.3 for help on manipulating it. You can access it:

- from the image menu: Windows → Dockable Dialogs → Pointer.
- from the Tab menu in any dockable dialog by clicking on  and selecting Add Tab → Pointer.

15.5.9.2 “Pointer” dialog options

Pixels Shows the position of the pointed pixel, in X (horizontal) and Y (vertical) coordinates, stated in pixels from the origin (the upper left corner of the canvas).

Units Shows the distance from the origin, in inches.

Pointer Bounding Box This information is active when a selection exists. X and Y are the coordinates of the upper left corner of the rectangular frame that bounds rectangular and ellipse selections. H and W are the height and width of this box.

This information also exists for the other selections, but they are of less interest and the bounding box is not visible.

This information concerning the selection remains unchanged when you use another tool, while pointer coordinates vary.

Channel values The channel values for the selected **color model** are shown below. Both pulldown menus contain the same choices, which makes it easier for you to compare the color values of a particular pixel using different color models. “Hex” is the **HTML Notation** of the pixel color, in hexadecimal. The choices on the pulldown menus are (Pixel is the default):

Pixel The **RGB** channel values. This choice displays the *Red, Green, Blue* and *Alpha* values of the pixel, as numbers between 0 and 255.

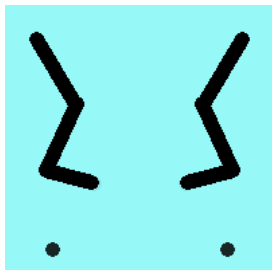
RGB The **RGB** channel values. This choice displays the *Red, Green, Blue* and *Alpha* values of the pixel, as percentages. It also shows the hexadecimal value of the pixel’s color.

HSV The **HSV** components. This choice displays the *Hue*, in degrees, as well as the *Saturation, Value* and *Alpha* of the pixel, as percentages.

CMYK The **CMYK** channel values. This choice displays the *Cyan, Magenta, Yellow, Black* and *Alpha* values of the pixel, as percentages.

Sample Merged If this option is checked (default), sampling is performed on all layers. If it is unchecked, sampling is performed on the active layer only.

15.5.10 Symmetry Painting dialog



Symmetry Painting is a new painting feature in GIMP-2.10, supported by brush-based tools (Pencil, Paintbrush, Eraser, Airbrush, MyPaint brush, Clone, Smudge, Dodge) as well the Ink tool. There are several kinds of symmetry, all configurable.

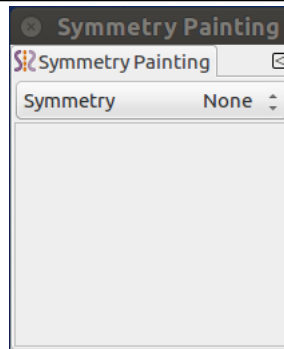
15.5.10.1 Activating the Dialog

You can access this dialog from the image Menu bar through: Windows → Dockable Dialogs → Symmetry Painting

The dialog “Symmetry Painting” is dockable. Read Section 3.2.3 to learn more about the concept of dockability.

15.5.10.2 Using the Symmetry Painting dialog

Figure 15.85 Symmetry Painting dialog



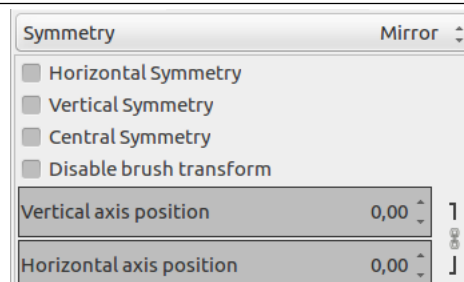
This dialog is very simple. You only have a Symmetry item with a drop down list that offers four options. As soon as you check a symmetry type, symmetry axes appear as dotted green lines in the image window and you can start painting with the brush you have chosen.

Options

none That is the default option; the symmetry painting is not activated.

Mirror

Figure 15.86 The Symmetry mirror dialog



This is a symmetry like in a mirror. You can select an Horizontal symmetry, a Vertical symmetry or a Central symmetry. You can also select several symmetries.

The default position for symmetry axis is the middle of the image window. You can place axis where you want using Horizontal axis position and Vertical axis position.

Disable brush transform: when you transform the drawing, the brush itself will end up transformed as well. For instance, in a mirror transform, not only will your drawing on the right of the canvas be mirrored on the left, but the brush itself is obviously “flipped” on the left. If for some reason, you want the drawn lines to be mirrored (or other transformation) but not the brush outline itself, you can check this box. For obvious reason, you won’t see it with symmetrical brushes though. That’s why you don’t see the effect since many default brushes are symmetrical.

Tiling “Tiling” is a translational symmetry, which can be finite (with a maximum of strokes) or infinite. In the latter case, it is the perfect tool to create patterns or seamless tiles, at painting time.

Figure 15.87 The Symmetry Tiling Dialog

Symmetry	Tiling
Interval X	320,00
Interval Y	240,00
Shift	0,00
Max strokes X	0
Max strokes Y	0

This mode covers the image with strokes.

No axes here. The options are:

- Interval X Interval Y: these are the intervals on X and Y axis, in pixels, between stroke centers.
- Shift: this the shift between lines on the X axis, in pixels.
- Max strokes X, Max strokes Y: these are the maximal number of brush strokes on X and Y axis. Default is 0, which means no limit, according to the image size.

Mandala

Figure 15.88 The Symmetry Mandala Dialog

Symmetry	Mandala
Center abscissa	320,00
Center ordinate	240,00
Number of points	6
<input type="checkbox"/> Disable brush transform	

Strokes are placed around the center of coordinates of axis.

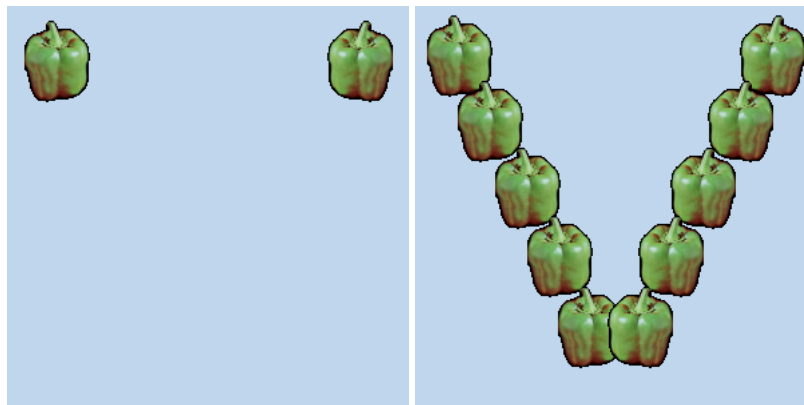
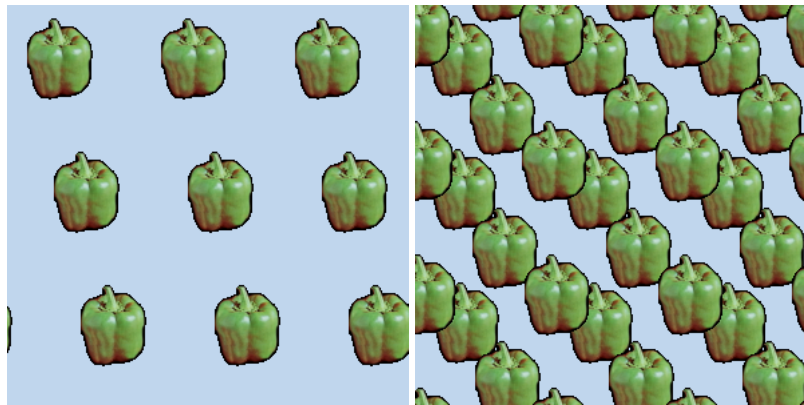
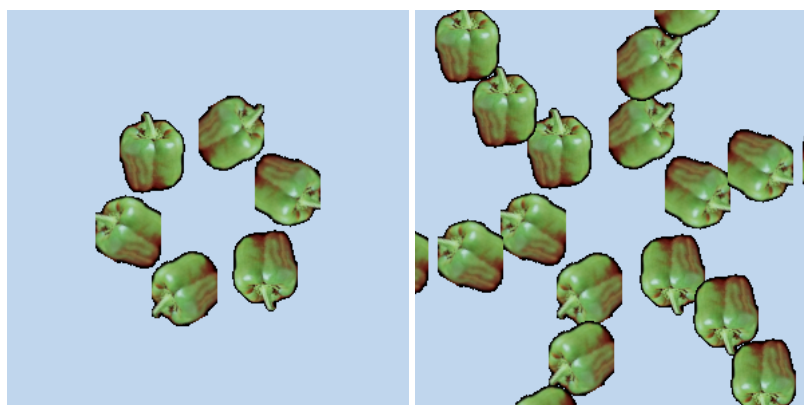
The options are:

- Center abscissa, Center ordinate to position the center of coordinates.
- Number of points: number of strokes.
- Disable brush transform: see above.

15.5.10.3 Examples

Pepper brush is selected. Pencil is used.

Example for Mirror

Figure 15.89 Vertical Symmetry(a) *A single click*(b) *A stroke***Example for Tiling****Figure 15.90**(a) *A single click. Shift = 20.*(b) *A stroke***Example for Mandala****Figure 15.91**(a) *A single click*(b) *A stroke*

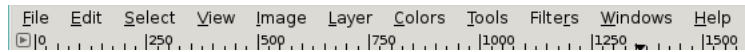
Chapter 16

Menus

16.1 Introduction to Menus

There are many places in GIMP where you can find menus. The aim of this chapter is to explain all the commands that are accessible from the image menu bar and the image menu you can get by right clicking in the canvas. All the context menus and the menu entries for the other dialogs are described elsewhere in the chapters that describe the dialogs themselves.

16.1.1 The Image Menu Bar



This menu bar may contain other entries if you have added script-fus, python-fus or videos to your GIMP.

16.1.2 Context Menus

If you right-click on certain parts of the GIMP interface, a “context menu” opens, which leads to a variety of functions. Some places where you can access context menus are:

- Clicking on an image window displays the Image menu. This is useful when you are working in full-screen mode, without a menubar.
- Clicking on a layer in the Layers Dialog or on a channel in the Channels Dialog displays functions for the selected layer or channel.
- Right-clicking on the image menubar has the same effect as left-clicking.
- Right-clicking on the title bar displays functions which do not belong to GIMP, but to the window manager program on your computer.

16.1.3 Tear-off menus


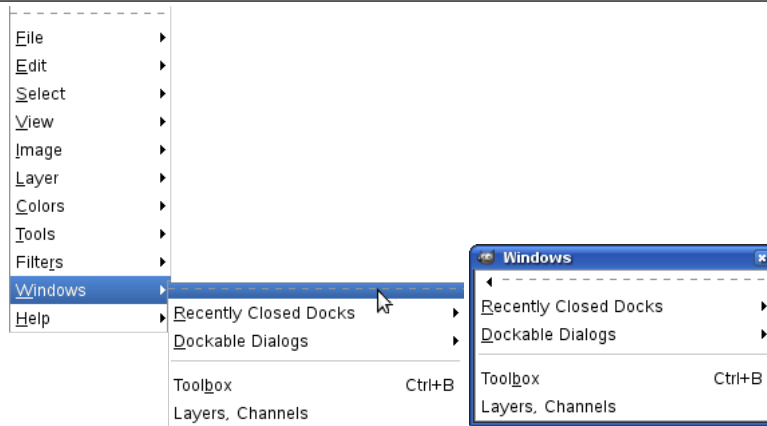
There is an interesting property associated with some of the menus in GIMP. These are any of the menus from the Image context menu you get by right-clicking on the canvas and any of its submenus. (You can tell that a menu item leads to a submenu because there is an  icon next to it.) When you bring up any of these menus, there is a dotted line at the top of it (tear-off line). By clicking on this dotted line, you detach the menu under it and it becomes a separate window.

Figure 16.1 The “windows” submenu and its tear-off submenu



Tear-off menus are actually independent. They are always visible, their functions always apply to the current image, and they persist when all of the images are closed. You can close a tear-off submenu by clicking on the dotted line again or closing the window from the window manager on your computer (often by clicking on an X icon in the upper right corner of the window).

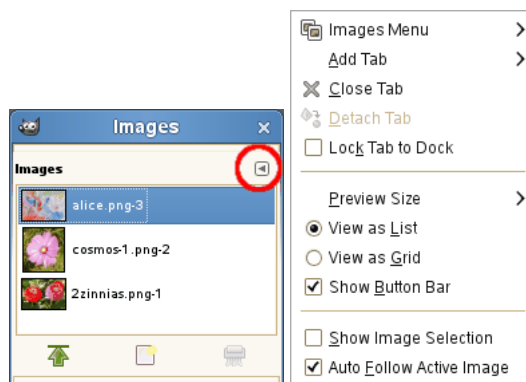
These tear-off submenus are also created in single-window mode, but are of less interest since they are masked by the window as soon as you click on it.

16.1.4 Tab menus

The following type of menu is not related to the image menu bar, but for the sake of completeness:

Every dockable dialog contains a Tab Menu button, as highlighted below. Pressing this Tab Menu button opens a special menu of tab-related operations, with an entry at the top that opens into the dialog’s context menu.

Figure 16.2 A dockable dialog.



(a) A dialog window with the Tab menu button highlighted.

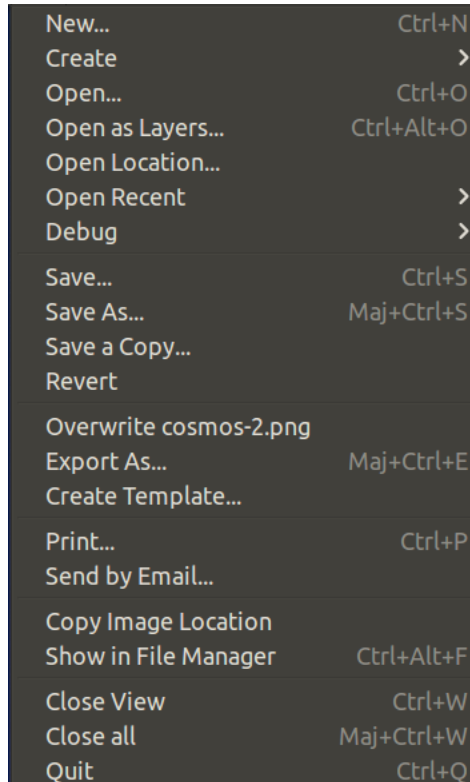
(b) The Tab menu.

See Section 3.2.3.2 to learn more about Tab menus.

16.2 The “File” Menu

16.2.1 Overview

Figure 16.3 The File menu



Note



Besides the commands described here, you may also find other entries in the menu. They are not part of GIMP itself, but have been added by extensions (plug-ins). You can find information about the functionality of a Plugin by referring to its documentation.

16.2.2 New...

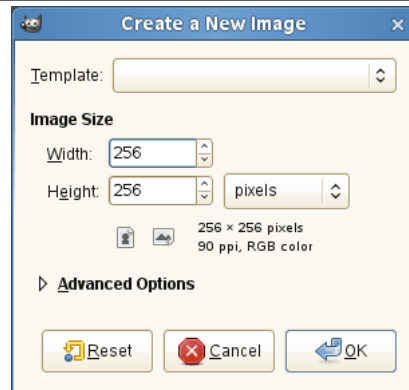
Using the “Create a New Image” dialog, you can create a new empty image and set its properties. The image is shown in a new image window. You may have more than one image on your screen at the same time.

16.2.2.1 Activate the command

- You can access the command in the image menu through: File → New...
- or by using the keyboard shortcut Ctrl-N.

16.2.2.2 Basic Options

Figure 16.4 The “Create a New Image” dialog



Template

Figure 16.5 The “Template” dialog



Rather than entering all the values by hand, you can select some predefined values for your image from a menu of templates, which represent image types that are somewhat commonly useful. The templates set values for the size, resolution, comments, etc. If there is a particular image shape that you use often and it does not appear on the list, you can create a new template, using the **Templates** dialog.

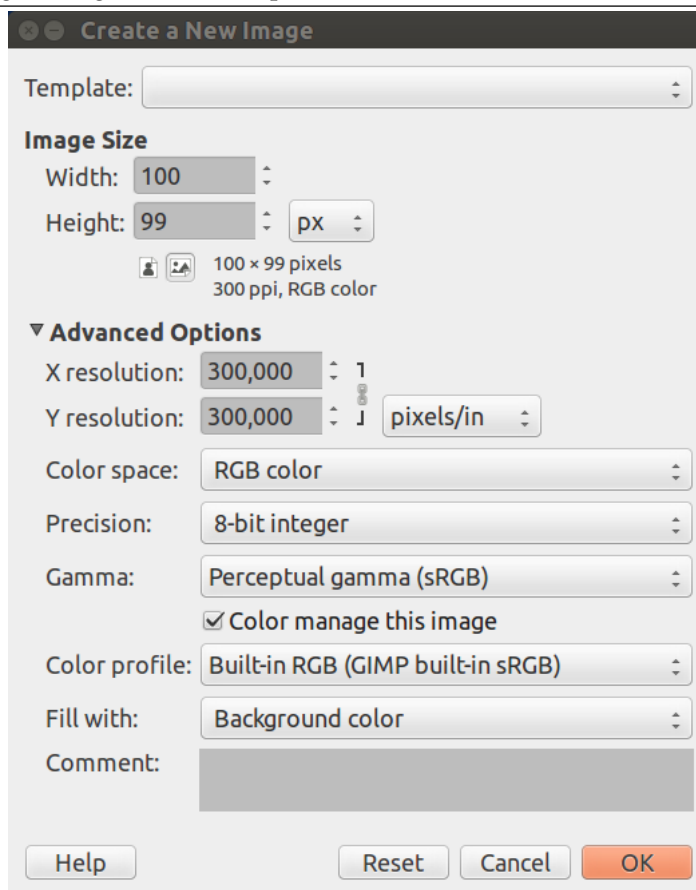
Image Size Here you set the Width and Height of the new image. The default units are pixels, but you can choose a different unit if you prefer, using the adjoining menu. If you do, note that the resulting pixel size is determined by the X and Y resolution (which you can change in the Advanced Options), and by setting “Dot for Dot” in the View menu.

If no image is open, the “New” image is opened in the empty image window, with the default size you have determined. If you open the “New” image when another is open (or has been), then it is opened in another window, with the same size as the first image.

Note

Keep in mind that every pixel of an image is stored in memory. If you create large files with a high pixel density, GIMP will need a lot of time and memory for every function you apply to the image.

Portrait/Landscape buttons There are two buttons which toggle between Portrait and Landscape mode. What they actually do is to exchange the values for Width and Height. (If the Width and Height are the same, these buttons are not activated.) If the X and Y resolutions are not the same (which you can set in Advanced Options), then these values are also exchanged. On the right of the dialog, image size, screen resolution and color space are displayed.

16.2.2.3 Advanced Options**Figure 16.6** New Image dialog (Advanced Options)

The Advanced Options are mostly of interest to more advanced GIMP users. You can display these options by clicking on the small triangle on the lower edge of the dialog window.

X and Y resolution The values in the X resolution and Y resolution fields relate mainly to printing: they do not affect the size of the image in pixels, but they may determine its physical size when it is printed. The X and Y resolution values can determine how pixels are translated into other measurement units, such as millimeters or inches.

Tip

If you want to display the image on the screen at the correct dimensions, select View → Dot for Dot Set the zoom factor to 100% to see the image at its true screen size. The calibration of the screen size is normally done when GIMP is installed, but if the image does not display at the correct size, you may have to adjust the screen parameters in the GIMP. You can do this in the **Preferences** dialog.

Colorspace You can create the new image in different **color modes**, as either an **RGB** image or a grayscale image.

RGB color The image is created in the Red, Green, Blue color system, which is the one used by your monitor or your television screen.

Grayscale The image is created in black and white, with various shades of gray. Aside from your artistic interests, this type of image may be necessary for some plug-ins. Nevertheless, the GIMP allows you to **change an RGB image into grayscale**, if you would like.

You cannot create an indexed image directly with this menu, but of course you can always convert the image to indexed mode after it has been created. To do that, use the Image → Mode → Indexed command.

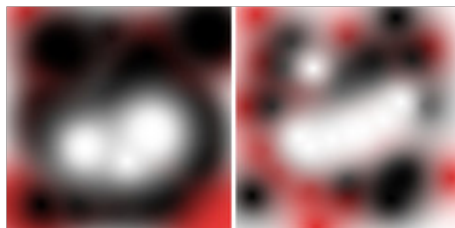
Precision A huge step for GIMP: 16-32 bits per channel support is at last available. You are now able to work with a lot more color information and detail in your pictures. This support basically gives you the ability to create super-smooth color transitions on your picture. Next improvement will be to have RAW files edited with GIMP *directly* since there is enough color space to bring back all the details that are stored inside a RAW file – however this is not implemented yet.

Five options are available:

- 8-bit integer
- 16-bit integer
- 32-bit integer
- 16-bit floating point
- 32-bit floating point

If you wonder what the difference is between integer and floating point (in the graphics area): If you have an image with 16-bit integer precision per channel, then you have 65.536 shades of different red, green and blue color tones – all of them equally stepped to each other (equal color distance). If you have it in floating point, then there are no equal-wide steps – so you can distribute the possible color values over selected ranges. For example: if you know that you have a very dark image with many shades of dark red color tones then you would benefit from floating point because you can decrease the importance of the brighter color tones and get most color detail out of only the darker reds.

Figure 16.7 Precision example



Left image is 8-bit, right is 32-bit. You can see that there are much more available colors between color transitions on the right image.

Fill with Here, you specify the background color that is used for your new image. It is certainly possible to change the background of an image later, too. You can find more information about doing that in the **Layer dialog**.

There are several choices:

- Fill the image with the current Foreground color, shown in the Toolbox.
Note that you can change the foreground color while the “New Image” dialog window is open.
- Fill the image with the current Background color, shown in the Toolbox. (You can change the background color too, while the dialog window is open.)
- Fill the image with White.
- Fill the image with Transparency. If you choose this option, the image is created with an **alpha channel** and the background is transparent. The transparent parts of the image are then displayed with a checkered pattern, to indicate the transparency.

You can write a descriptive comment here. The text is attached to the image as a **parasite**, and is saved with the image by some file formats (PNG, JPEG, GIF).

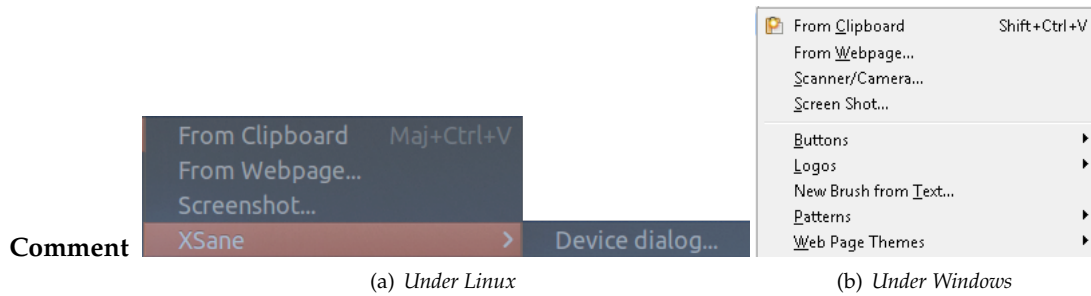
Note



You can view and edit this comment in the **Image Properties** dialog.

16.2.3 Create

Figure 16.8 The “Create” submenu



This menu item replaces the “Acquire” menu which existed in GIMP previous versions in the Toolbox Menu and contains a lot of logos, buttons, patterns...

These commands vary somewhat, depending upon your system, since the GIMP makes calls to system functions.

16.2.3.1 Activate the Submenu

- You can access this submenu from the Image menu bar through File → Create

16.2.3.2 From Clipboard

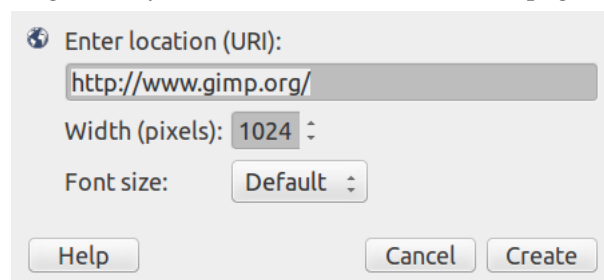
When you copy a selection, it goes into the clipboard. Then you can create a new image with it.

This command has the same action as the **Paste as / New Image** command.

The **Print Screen** keyboard key captures the screen and puts it in the clipboard. This command has the same action as “taking a screenshot of the entire screen” in the **Screenshot** dialog window. The Alt-Print Screen key combination grabs the active window in the screen with its decorations and puts it in the clipboard.

16.2.3.3 From Web page

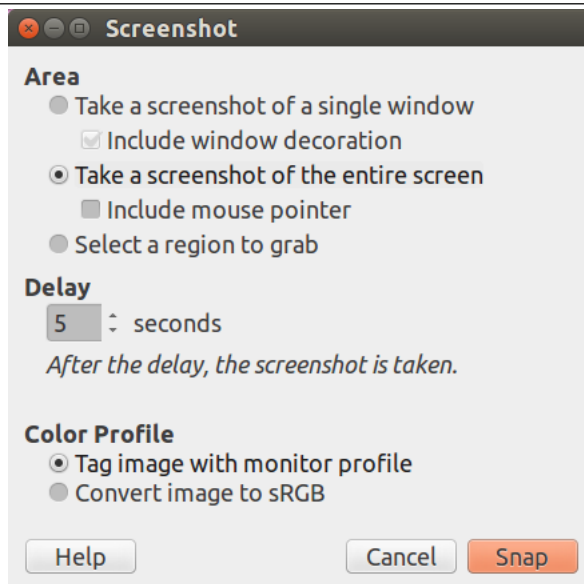
This command opens a dialog where you can enter the URL of a Web page and get the image in GIMP.



The command defaults to gimp.org. Please have a try to it.

16.2.3.4 Screenshot

Figure 16.9 The "Screenshot" window



The Screenshot command opens a dialog with two parts:

Area

Take a screenshot of a single window The mouse pointer becomes a cross. Click in the image window you want to capture. A new image is created. If the Include window decoration option is unchecked, the title bar and the blue frame around the image will be removed.

Take a screenshot of the entire screen This is useful if you want to capture a pop menu. A delay is then necessary, so that you have time to pull the pop menu down.

If the Include mouse pointer option is checked, then the mouse pointer and its coming with icon are also captured. The mouse pointer is captured in a separate layer. So you can move it to another place in the image.

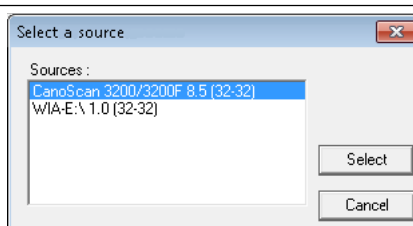
Select a region to grab The mouse pointer becomes a cross. Click and drag to create a rectangular selection in the image window. This selection will be opened as a new image. Its size is adapted to the selection size.

Delay When taking a screenshot of the entire screen, the screen is captured after this delay. In the other cases, the mouse pointer turns to a cross after this delay.

16.2.3.5 Scanner/Camera

This item is present in Windows operating system, using TWAIN. Image input devices appear in the dialog, if they are plugged-in. On Linux, you need to install third-party XSane plug-in which will be available in the File → Create → XSane → Device dialog... menu.

Figure 16.10 Scanner and Camera



The kinds of devices used to take pictures are too varied to be described here. Fortunately, their use is fairly intuitive. In the example shown (under Windows 7), you can start a scanner or load an image from a camera card.

16.2.3.6 Buttons, Logos, Patterns, Web Page Themes

An impressive list of Script-Fus. Have a look at it!

16.2.4 Open...

The Open... command activates a dialog that lets you load an existing image from your hard-drive or an external medium. For alternative, and sometimes more convenient, ways of opening files, see the following commands (Section 16.2.5 etc.).

16.2.4.1 Activate Dialog

- You can access the Open dialog from an image window through: File → Open....
- You can also open this dialog by using the keyboard shortcut Ctrl-O.

16.2.4.2 File browsing

Figure 16.11 The Open Image Dialog

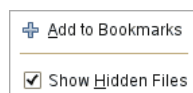


This browser looks like other browsers and it is mostly self-explanatory. It has some particular features nevertheless.

1. The button Type a file name toggles between add and remove the Location text box. The Ctrl-L key combination has the same action as this button.
2. In the Location text box you can type a path to an image file. If you don't type any path, the name of the selected file will be displayed. You can also type the first letters of the name: it will be auto-completed and a list of file names beginning with these letters will be displayed. When you search for a file or directory using the Search feature (see below, item 4), the label changes to Search and you can enter the name in this text box.
3. The path to the current folder is displayed. You can navigate along this path by clicking on an element.
4. With Search you can look for a file (or directory), even if you don't know the exact name of that file. Click on Search, type a file name or just a part of a file name in the text box above, and press **Enter**. Then the central frame (7) will list all files and directories of your home directory with names containing the text you typed in. Unfortunately you can't restrict the results to files of a specified type (10). Recently used is self-explanatory.

5. Here, you can access to your main folders and to your store devices.
6. Here, you can add bookmarks to folders, by using the Add or the Add to Bookmarks option you get by right-clicking a folder in the central panel, and also remove them.
7. The contents of the selected folder is displayed here. Change your current folder by double left clicking on a folder in this panel. Select a file with a single left click. You can then open the file you have selected by clicking on the Open button. A double left click opens the file directly. Please note that you can open image files only.

Right-clicking a folder name opens a context menu:



The folder context menu

8. The selected image is displayed in the Preview window. If it is an image created by GIMP, file size, resolution and image composition are displayed below the preview window.

Tip



If your image has been modified by another program, click on the Preview window to update it.

9. By clicking the Add button, you add the selected folder to bookmarks.
By clicking the Remove, you remove the selected bookmark from the list.
10. You will generally prefer to display the names of All images. You can also select All files. You can also limit yourself to a particular type of image (GIF, JPG, PNG ...).
11. Select File Type: In most cases you don't need to pay any attention to this, because GIMP can determine the file type automatically. In a few rare situations, neither the file extension nor internal information in the file are enough to tell GIMP the file type. If this happens, you can set it by selecting it from the list.

16.2.5 Open as Layers...

The Open Image as layers command opens the **Open Image** dialog. The layers of the selected file are added to the current image as the top layers in the stack.

16.2.5.1 Activate Command

- You can access this command from the image menubar through File → Open as layers...,
- or by using the keyboard shortcut Ctrl-Alt-O.

16.2.6 Open Location...

This command opens the “Open Location” dialog that lets you load an image from a network location, specified by a URL, in any of the formats that GIMP supports.

16.2.6.1 Activate Command

- You can access this command from the Toolbox menubar or the image menubar through File → Open Location....

16.2.6.2 Description of the dialog window

Figure 16.12 The “Open Location” dialog window



The most typical schemes to open images with are:

file:// to open an image from a local drive

You can omit the “file://” prefix and open images simply by putting an absolute or relative path and filename in here.

The default base directory for relative paths depends on your operating system. It is typically `/home/<username>/` on Linux, `C:\Documents and Settings\<username>` on Windows and `/Users/<username>/` on Mac OS X.

ftp:// to open an image from a ftp server

http:// to load an image from a website

Tip



When you are visiting an Internet site, you can right-click on an image and choose “Copy link address” in the drop-down menu. Then paste it in the “Open Location” dialog to open it in GIMP.

Even if this command makes it very easy to grab images from web sites: *Please respect the copyright! Images, even if published on the Internet are not always free to be used for you.*

16.2.7 Open Recent

Selecting Open Recent displays a submenu with the names of the files that you have opened recently in GIMP. Simply click on a name to reopen it. See the [Document History dialog](#) at the bottom of the Open Recent submenu if you cannot find your image.

16.2.7.1 Activate Command

- You can access this command from the image menubar through File → Open Recent.

16.2.8 Save

This command opens Section [15.5.6](#).

16.2.9 Save as...

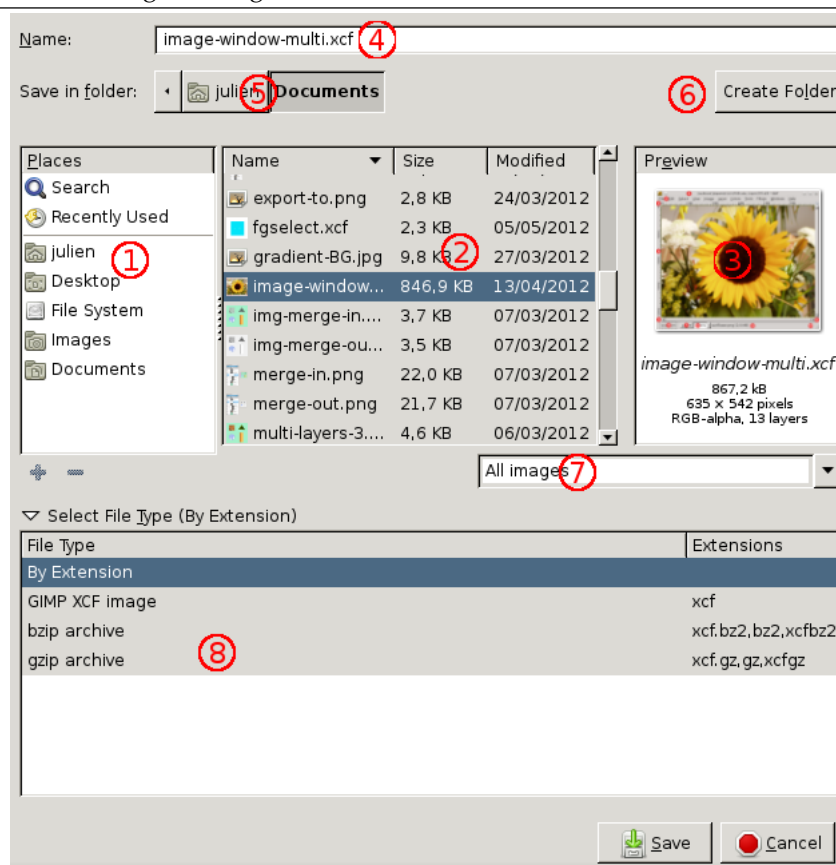
The Save as command displays the “Save Image” dialog. Since GIMP-2.8, the file is automatically saved in the XCF format and you can’t *save* in another file format (for this, you have to *export* the file). The Save as dialog allows you to save with another name and/or to another folder.

16.2.9.1 Activating the Command

- You can access this command from the image menubar through File → Save As...
- or by using the keyboard shortcut Shift-Ctrl-S.

16.2.9.2 The "Save Image" dialog

Figure 16.13 The "Save Image" dialog



1. The left panel is divided into two parts. The upper part lists your main directories and your storage devices; you cannot modify this list. The lower part lists your bookmarks; you can add or remove *bookmarks*. To add a bookmark, select a directory or a file in the middle panel and click on the Add button at the bottom of the left panel. You can also use the Add to bookmarks command in the context menu, which you get by clicking the right mouse button. You can delete a bookmark by selecting it and clicking on the Remove button.
2. The middle panel displays a list of the files in the current directory. Change your current directory by double left-clicking on a directory in this panel. Select a file with a single left click. You can then save to the file you have selected by clicking on the Save button. Note that a double left click saves the file directly.
You can right click on the middle panel to access the *Show Hidden Files* command.
3. The selected image is displayed in the Preview window. File size, resolution and image composition are displayed below the preview window.
If your image has been modified by another program, click on the preview to update it.
4. Enter the filename of the new image file here.

Note

If the image has already been saved, GIMP suggests the same filename to you. If you click on *Save*, the file is overwritten.

5. Above the middle panel, the path of the current directory is displayed. You can navigate along this path by clicking on one of the buttons.
6. If you want to save the image into a folder that doesn't yet exist, you can create it by clicking on *Create Folder* and following the instructions.
7. This button shows *All Images* by default. This means that all images will be displayed in the middle panel, whatever their file type. By developing this list, you can choose to show only one type of file.
8. At *Select File Type*, you can select a compressed format for your XCF file.

16.2.10 Save a Copy...

The *Save a Copy* command does the same thing as the *Save* command, but with one important difference. It always asks for a file name and saves the image into the XCF file format, but it does not change the name of the active image or mark it as “clean”. As a result, if you try to delete the image, or exit from GIMP, you are informed that the image is “dirty” and given an opportunity to save it.

This command is useful when you want to save a copy of your image in its current state, but continue to work with the original file without interruption.

16.2.10.1 Activate Command

- You can access this command from the image menubar through *File* → *Save a Copy...* There is no default keyboard shortcut.

16.2.11 Revert

The *Revert* command reloads the image from disk, so that it looks just like it did the last time it was saved — unless, that is, you or some application other than GIMP have modified the image file, in which case, the new contents are loaded.

Warning

When GIMP reverts a file, it actually closes the existing image and creates a new image. Because of this, reverting an image is not undoable, and causes the undo history of the image to be lost. GIMP tries to protect you from losing your work in this way by asking you to confirm that you really want to revert the image.

16.2.11.1 Activate Command

- You can access this command from the image menubar through *File* → *Revert*. There is no default keyboard shortcut.

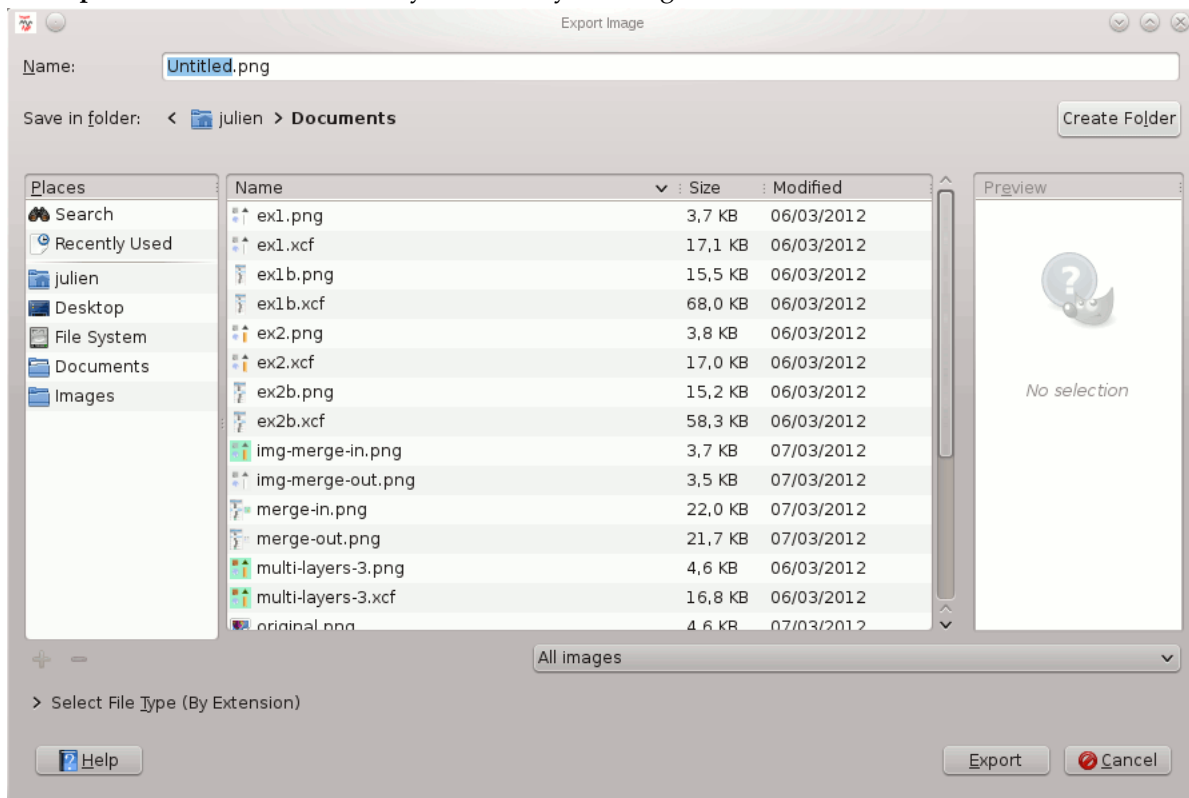
16.2.12 Export...

This command is called “*Export*” for a native XCF file. Then, it does the same thing as **Export As...** At early GIMP 2.8 releases, this menu label was “*Export to*”. Since the version 2.8.10, “*Export to*” and “*Export*” have been renamed to “*Export*” and “*Export As*” after the manner of “*Save*” and “*Save As*”.

The name becomes “Overwriting name.extension” for an imported image. So, you can export the imported image directly in its original file format, without going through the export dialog.

16.2.13 Export As...

The **Export As...** command allows you to store your image in a format other than XCF.



Note



Please refer to Section 6.1 for information about exporting in different file formats.

16.2.13.1 Activating the Command

- You can access this command from the image menubar through File → Export As...,
- or by using the keyboard shortcut Shift-Ctrl-E.

16.2.14 Create Template...

The Create Template... command opens the “Create New Template” dialog that allows you to create a template with the same dimensions and color space as the current image. A dialog pops up, which asks you to name the new template. Then the template is saved and becomes available in the **New Image** dialog. If you give a name that already exists, GIMP generates a unique name by appending a number to it. You can use the **Templates** dialog to modify or delete templates.

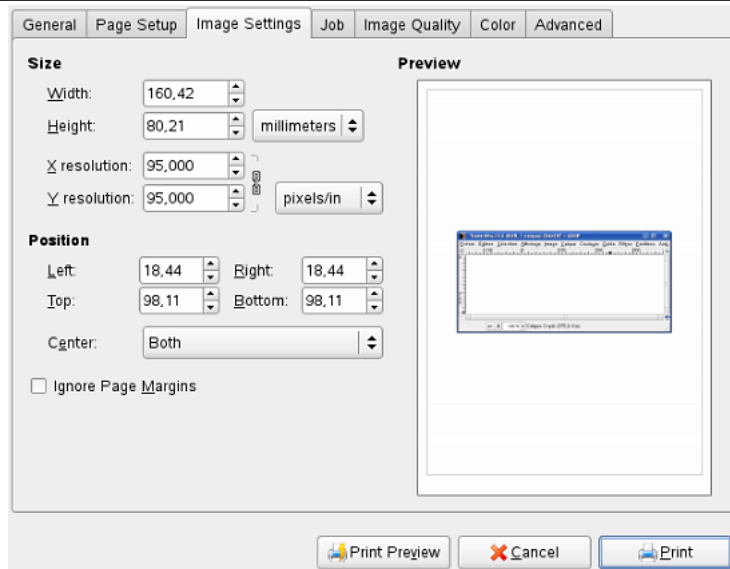
16.2.14.1 Activating the Command

- You can access this command from the image menu through File → Create Template.... There is no default keyboard shortcut.

16.2.15 Print

Since the 2.4.0 release, GIMP has its own printing module. You can set page and image up. A preview button allows you to verify the result before printing.

Figure 16.14 The "Print" dialog



Note



See [Printing your photos](#).

16.2.15.1 Activate Command

You can access this command from the image menubar through File → Print, or by using Ctrl-P.

16.2.16 Send by Email

You can access this command from the image menubar through File → Send by Email....

This command opens a small dialog with the name of the image to be sent (you can edit it). Clicking on the Send button opens your default mail software with the image attached.

16.2.17 Copy Image Location

You can access this command from the image menubar through File → Copy Image Location.

This command copies the image path to the clipboard. So, you can past it in a text.

16.2.18 Show in File Manager

You can access this command from the image menubar through File → Show in File Manager.

This command opens the file manager in the directory containing the active image

16.2.19 Close

The Close command closes the active image. It is disabled if no image is open.

Closing an image is not undoable: once it is closed, everything is gone, including the undo history. If the image is not “clean” — that is, if you have changed it since the last time you saved it — you are asked to confirm that you really want to close it. Note that an image is marked as clean when it is saved to a file, even if the file format chosen does not preserve all the information in the image, so it is a good idea to think for a moment about what you are doing before closing an image. If there is the slightest possibility that you will regret it, save the file (automatically in the XCF file format since GIMP-2.8).

16.2.19.1 Activating the Command

- You can access this command from the image menu through File → Close,
- or by using the keyboard shortcut Ctrl-W.
- For most systems on which the GIMP runs, you can also execute it by clicking on a “Close” button somewhere on the image window titlebar. The location and appearance of this button are determined by the windowing system and the window manager. If no image is open, clicking on this button closes GIMP.

16.2.20 Close all

This command closes all images you have opened.

16.2.20.1 Activate the Command

- You can access this command from the image menubar through File → Close All,
- or by using the keyboard shortcut Shift-Ctrl-W.

16.2.21 Quit

The Quit command causes GIMP to close all images and exit. If there are any open images which contain unsaved changes (that is, they are not marked as “clean”), GIMP notifies you and displays a list of the unsaved images. You can then choose which images you would like to save, or you can cancel the command. Note that if you have a large number of images open, or are using a large part of the RAM on your system, it may take a little while for everything to shut down.

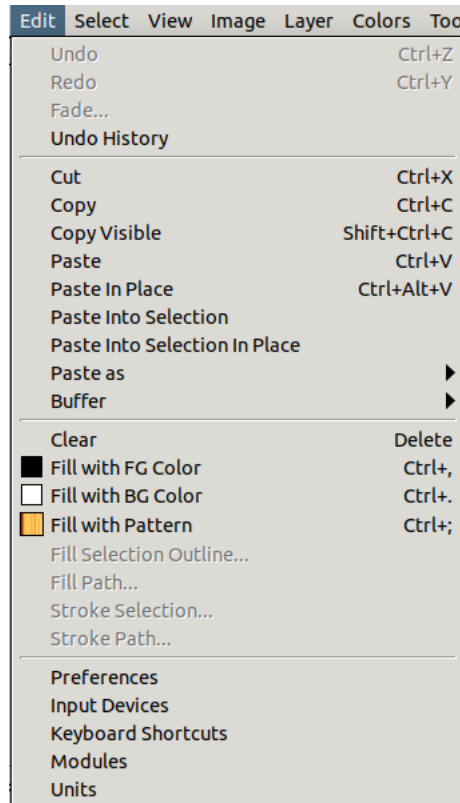
16.2.21.1 Activate Command

- You can access this command from the image menubar through File → Quit,
- or by using the keyboard shortcut Ctrl-Q.
- For most systems on which the GIMP runs, you can also execute it by clicking on a “Close” button somewhere on the main image window’s titlebar. The location and appearance of this button are determined by the windowing system and the window manager. Clicking on this button closes GIMP when no image is open.

16.3 The “Edit” Menu

16.3.1 “Edit” Menu Entries

Figure 16.15 Contents of the Edit Menu



In this section, you will find help for commands in the Edit menu item.

Note



Besides the commands described here, you may also find other entries in the menu. They are not part of GIMP itself, but have been added by extensions (plug-ins). You can find information about the functionality of a Plugin by referring to its documentation.

16.3.2 Undo

If you have made drawing or editing changes to the image which you don't want to keep, the Undo command allows you to undo the last change and return the image to its previous state. Almost anything you do to an image can be undone in this way (with the exception of scripts, which deactivate this function). Further Undo operations may be performed, depending upon the number of Undo levels configured in the [System Resources](#) page of the Preferences Dialog. See the section on [Undoing](#) for more information about GIMP's very sophisticated “Undo” functions.

The operation that has been “undone” is not lost immediately: you can get it back by using the [Redo](#) command right away. But if you perform another operation, the ability to “Redo” will be irretrievably lost.

16.3.2.1 Activate the Command

- You can access this command from the image menubar through Edit → Undo,

- by using the keyboard shortcut Ctrl-Z,
- or by simply clicking on the status you want in the Undo History dialog.

16.3.3 Redo

The Redo command reverses the effects of the Undo command. Each “Undo” action can be reversed by a single “Redo” action. You can alternate “Undo” and “Redo” as many times as you like. Note that you can only “Redo” an operation if the last action you did was an “Undo”. If you perform any operation on the image after Undoing something, then the former Redo steps are lost, and there is no way to recover them. See the [Undoing](#) section for more information.

To see the operations which you have done and undone, use the [Undo History](#) dialog.

16.3.3.1 Activating the Command

- You can access this command from the image menubar through Edit → Redo,
- by using the keyboard shortcut Ctrl-Y,
- or by simply clicking on the status you want in the [Undo History dialog](#).

16.3.4 Undo History

The Undo History command activates the [Undo History dialog](#), which shows you thumbnails representing the operations you have done so far on the current image. This overview makes it easier for you to undo steps or to redo them.

Use the arrows for [Undo](#) and [Redo](#), or simply click on the thumbnail, to bring the image back to a previous state. This is especially useful when you are working on a difficult task, where you often need to undo several steps at once. It is much easier to click on step 10 than to type Ctrl-Z ten times.

The “Clear undo History” command may be useful if you are working on a complex image and you want to free some memory.

16.3.4.1 Activating the Command

- You can access this command from the image menubar through Edit → Undo History. There is no default keyboard shortcut.

16.3.5 Cut

The Cut command deletes the contents of the image’s selections, and saves them in a clipboard so that they can later be pasted using the “Paste”, “Paste Into”, or “Paste As New” commands. If there is no selection, the entire current layer is cut. The areas whose contents are cut are left transparent, if the layer has an alpha channel, or filled with the layer’s background color, otherwise.

Note



The Cut command only works on the current active layer. Any layers above or below the active layer are ignored.

16.3.5.1 Activate the Command

- You can access this command from the image menubar through Edit → Cut,
- or by using the keyboard shortcut Ctrl-X.

16.3.6 Copy

The Copy command makes a copy of the current selection and stores it in the Clipboard. The information can be recalled using the **Paste**, **Paste Into Selection**, or **Paste As / New Image** commands. If there is no selection, the entire current layer is copied. “Copy” only works on the current active layer. Any layers above or below it are ignored.

16.3.6.1 Activate the Command

- You can access this command from the image menubar through Edit → Copy,
- or by using the keyboard shortcut Ctrl-C.

16.3.7 Copy Visible

The Copy Visible command is similar to the **Copy** command. However, it does not just copy the contents of the current layer; it copies the contents of the visible layers (or the selection of the visible layers), that is, the ones that are marked with an “eye”.

Note



Please note that the information about the layers is lost when the image data is put in the clipboard. When you later paste the clipboard contents, there is only one layer, which is the fusion of all the marked layers.

16.3.7.1 Activating the Command

You can access this command from the image menubar through Edit → Copy Visible.

16.3.8 Paste

The Paste command puts whatever is in the Clipboard from the last “Copy” or “Cut” command into the current image. The pasted section becomes a “floating selection” and is shown as a separate layer in the Layers Dialog.

If there is an existing selection on the canvas, it is used to align the pasted data. If there is already a selection, the data is pasted using the selection as a center point. If you want the selection to be used as a clipping region for the pasted data, you should use the “Paste Into Selection” command.

Note



You can have only *one* floating selection at any one time. You cannot work on any other layer while there is a floating selection; you have to either anchor it or remove it.

16.3.8.1 Activate the Command

- You can access this command from the image menubar through Edit → Paste.
- or by using the keyboard shortcut Ctrl-V.

16.3.9 Paste Into Selection

The Paste Into Selection command acts in a similar way to the Paste command. The primary difference becomes apparent if there is a selection within the canvas. Unlike the “Paste” command, which simply centers the pasted image data over the selection and replaces the selection with its own, “Paste Into Selection” clips the pasted image data by the existing selection. The new selection can be moved as usual, but it is always clipped by the original selection area.

If no selection exists, the “Paste Into Selection” command places the data from the Clipboard into the center of the canvas, as the “Paste” command does.

16.3.9.1 Activate the Command

You can access this command from the image menubar through Edit → Paste Into Selection.

16.3.10 Paste In Place

The usual Paste command places the contents of the clipboard into the center of canvas. With this command, you can paste the contents of the clipboard at exact coordinates the contents was originally copied from. This feature is available for both the regular clipboard and named buffers.

16.3.10.1 Activate the Command

You can access this command from the image menubar through Edit → Paste In Place.

16.3.11 Paste Into Selection In Place

The Paste Into Selection command places the contents of the clipboard into the center of the selection. With Paste Into Selection In Place, you can paste the contents of the clipboard at exact coordinates the contents was originally copied from. This feature is available for both the regular clipboard and named buffers.

16.3.11.1 Activate the Command

You can access this command from the image menubar through Edit → Paste Into Selection In Place.

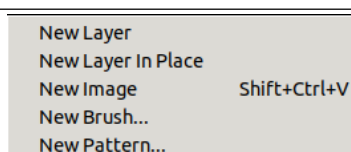
16.3.12 Paste as

This command pastes the clipboard contents. Of course, you must use the “Copy” command before, so that you have something in the clipboard. Else you will be prompted a warning:



or, if there is something you have forgotten, it will be pasted! There is no way to empty the clipboard. This command leads to the sub-menu:

Figure 16.16 The “Paste as” sub-menu



- Section [16.3.12.1](#)
- Section [16.3.12.2](#)
- Section [16.3.12.3](#)

- Section [16.3.12.4](#)
- Section [16.3.12.5](#)

16.3.12.1 Paste as New Layer

The Paste As New Layer command creates a new layer in the active image and pastes the image data from the Clipboard into it. If the data are not rectangular or square in shape, any regions that do not extend to the edge of the canvas are left transparent (an Alpha channel is automatically created). Of course, you have to Copy your selection before you use this command.

16.3.12.1.1 Activate the Command

You can access this command from the image menubar through Edit → Paste as → New Layer.

16.3.12.2 Paste As New Layer In Place

The Paste As New Layer In Place command creates a new layer in the active image and pastes the clipboard contents at exact coordinates the contents was originally copied from.

This feature is available for both the regular clipboard and named buffers.

16.3.12.2.1 Activate the Command

You can access this command from the image menubar through Edit → Paste as → New Layer In Place.

16.3.12.3 Paste as New Image

The Paste As New Image command creates a new image and pastes the image data from the Clipboard into it. If the data is not rectangular or square in shape, any regions outside the selection are left transparent (an alpha channel is automatically created). Of course, you have to copy your selection before you use this command, so that you get an image with the same dimensions as the selection.

This command has the same action as the File → Create → From Clipboard command.

16.3.12.3.1 Activate the Command

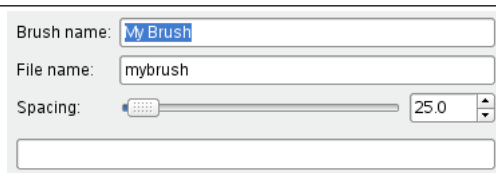
You can access this command from the image menubar through Edit → Paste as → New Image, or using the keyboard shortcut Shift-Ctrl-V .

16.3.12.4 Paste as New Brush

This command opens a dialog window which lets you name the new brush. The brush appears in the [Brushes dialog](#).

16.3.12.4.1 Options

Figure 16.17 The “New Brush” dialog



Brush name Brush name is the name as it will be in the “Brushes” Dialog.

File name The new brush is saved as File name (with extension .gbr) in your personal brushes folder.

Spacing Spacing: When the brush draws a line, it actually stamps the brush icon repeatedly. If brush stamps are very close, you get the impression of a solid line.

16.3.12.4.2 Activate the Command

- You can access this command from the image menubar through Edit → Paste as → New Brush....

16.3.12.5 Paste as New Pattern

This command opens a dialog window which allows you to name your new pattern. The pattern appears in the [Patterns dialog](#).

16.3.12.5.1 Options

Figure 16.18 The "New Pattern" dialog



Pattern name Pattern name is the name as it will be in the Pattern Dialog.

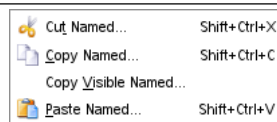
File name The new pattern is saved as File name (with extension `.pat`) in your personal `patterns` folder.

16.3.12.5.2 Activate the Command

You can access this command from the image menubar through Edit → Paste as → New Pattern....

16.3.13 Buffer

Figure 16.19 The "Buffer" submenu of the "Edit" menu



The commands in this submenu operate on *named buffers*. You can use the [Buffers dialog](#) to view and manage any named buffers you have created.

16.3.13.1 Activate the Submenu

You can access this submenu from the image menubar through Edit → Buffer.

16.3.13.2 Sub-menu entries

Cut Named The Cut Named command cuts the content of the selection from the active layer in the usual way, but instead of storing the contents in the global clipboard, it stores it in a special buffer that you name using a pop-up dialog.

Copy Named The Copy Named command copies the contents of the selection from the active layer in the usual way, but instead of storing the content in the global clipboard, it stores it in a special buffer that you name using a pop-up dialog.

Copy Visible Named The Copy Visible Named command copies the content of the selection from all the visible layers in the usual way, but instead of storing the content in the global clipboard, it stores it in a special buffer that you name using a pop-up dialog.

Paste Named The Paste Named command simply brings up the [Buffers dialog](#). By selecting one of the listed buffers, and pressing one of the buttons at the bottom, you can either [Paste Buffer](#), [Paste Buffer Into](#), or [Paste Buffer as New](#).

16.3.14 Clear

The Clear command deletes everything in the current selection. If there is no current selection, the contents of the active layer are removed. If the active layer has an alpha channel, the deleted selection is made transparent. You can restore the original color to the transparent area using the Eraser tool, by setting it to Anti-Erase. If the layer does not have an alpha channel, the deleted area is filled using the current background color.

Clearing a selection does not delete the selection itself. Unlike “Cut”, “Clear” does not place the deleted contents in the Clipboard and the contents of the clipboard are unaffected.

16.3.14.1 Activate the Command

- You can access this command from the image menubar through Edit → Clear,
- or by using the keyboard shortcut **Delete**.

16.3.15 Fill with FG Color

The Fill with FG Color command fills the image’s selection with the solid color shown in the foreground part of the Color Area of the Toolbox. (The color is also shown to the left of the menu entry.) If some areas of the image are only partially selected (for example, as a result of feathering the selection), they are filled in proportion to how much they are selected.

Note



Please note that if the image has no selection, the whole active layer is filled.

16.3.15.1 Activate the Command

- You can access this command from the image menubar through Edit → Fill with FG Color,
- or by using the keyboard shortcut Ctrl-.,

Note



You can also fill a selection by click-and-dragging from the Toolbox foreground color.

16.3.16 Fill with BG Color

The Fill with BG Color command fills the active layer selection with the solid color shown in the Background part of the Color Area of the Toolbox. (The color is also shown to the left of the menu entry.) If some areas of the image are only partially selected (for example, as a result of feathering the selection), they are filled in proportion to how much they are selected.

Note



Please note that if the image has no selection, the whole active layer is filled.

16.3.16.1 Activate the Command

- You can access this command from the image menubar through Edit → Fill with BG Color,
- or by using the keyboard shortcut Ctrl-..

Note



You can also fill a selection by click-and-dragging from the Toolbox background color.

16.3.17 Fill with Pattern

The Fill with Pattern command fills the image’s selection with the pattern shown in the Brush/Pattern/-Gradient area of the Toolbox. (The pattern is also shown to the left of the menu entry.) If some areas of the image are only partially selected (for example, as a result of feathering the selection), they are filled in proportion to how much they are selected.

You can select another pattern by using the [Pattern Dialog](#).

Note



Please note that if the image has no selection, the whole active layer is filled.

16.3.17.1 Activate the Command

- You can access this command from the image menubar through Edit → Fill with Pattern,
- or by using the keyboard shortcut Ctrl-;.

16.3.18 Fill Selection Outline

This command is usually grayed out. It becomes active when a selection exists.

TODO.

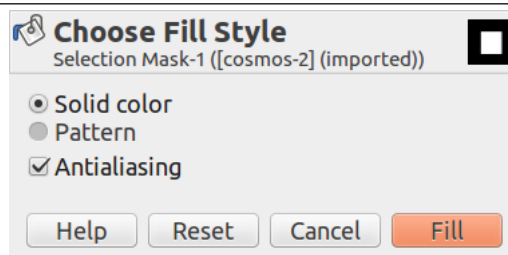
16.3.18.1 Activate the command

You can get to this command from the image Menu bar through: Edit → Fill Selection Outline...

16.3.18.2 Options

This command brings up a dialog window:

Figure 16.20 The “Choose Fill Style” dialog



Solid color The foreground color of the toolbox is used.

Pattern The active pattern of the toolbox is used.

Antialiasing This option is checked by default.

16.3.19 Fill Path

This command is usually grayed out. It becomes active when a path exists.

This function fills all areas delimited by the path from the origine to the end

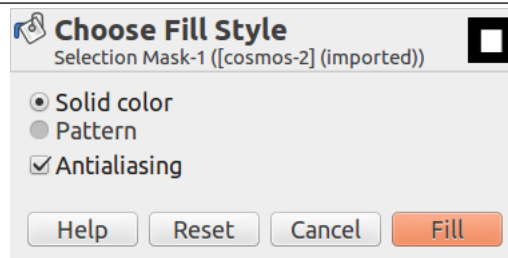
16.3.19.1 Activate the command

You can get to this command from the image Menu bar through: Edit → Fill Path...

16.3.19.2 Options

This command brings up a dialog window:

Figure 16.21 The "Choose Fill Style" dialog

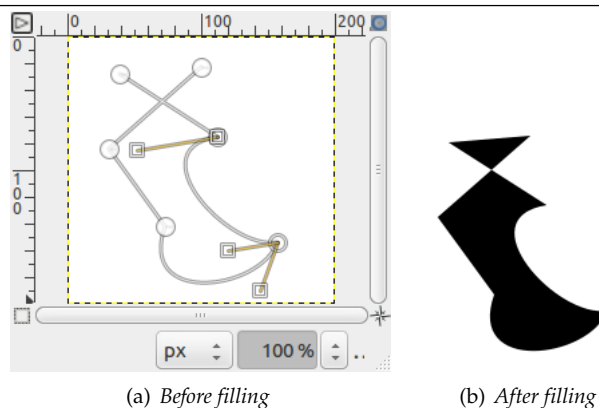


Solid color The foreground color of the toolbox is used.

Pattern The active pattern of the toolbox is used.

Antialiasing This option is checked by default.

Figure 16.22 Fill Path Example



16.3.20 Stroke Selection

The Stroke Selection command strokes a selection in the image. There are two ways you can stroke the selection, either by using a paint tool or without using one. This means that the selection border, which is emphasized in the image with a dotted line, can be drawn with a stroke. There are various options which you can use to specify how this stroke should look.

Note

This command is only active if the image has an active selection.

16.3.20.1 Activate the Command

- You can access this command from the image menubar through Edit → Stroke Selection.
- You can also access it through the [Selection Editor](#).

16.3.20.2 The “Stroke Selection” dialog**Note**

The options for stroking selections and for stroking paths are the same. You can find the documentation about the options in the dialog box in the [Stroke Path](#) section.

16.3.21 Stroke Path

The Stroke Path command strokes a path in the image. There are two ways you can stroke the path, either by using a paint tool, or without using one. There are various options which you can use to specify how this stroke should look.

Note

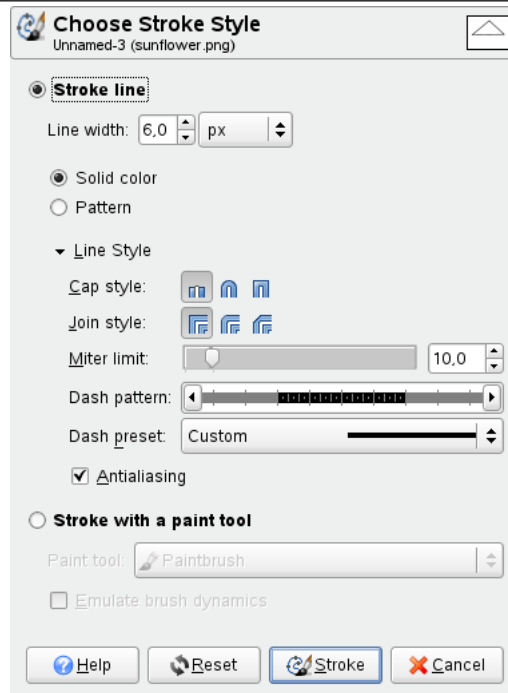
This command is active only if there is a path in your image.

16.3.21.1 Activating the Command

- You can access this command from the image menubar through Edit → Stroke Path.
- You can also access it by clicking on the button with the same name in the [Path dialog](#).

16.3.21.2 Description of the Dialog Window

Figure 16.23 The "Choose Stroke Style" dialog window



The Choose Stroke Style dialog box allows you to choose between stroking the path with the options you specify or stroking it with a paint tool. If you stroke the path with a paint tool, the current paint tool options are used to draw the stroke.

Stroke line

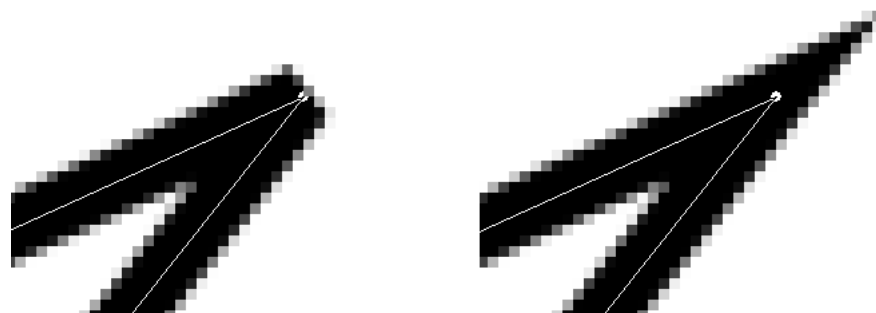
The stroke is drawn with the current foreground color, set in the Toolbox. By clicking on the triangle next to Line Style however, the dialog expands and you can set several additional options:

Line Width You can set the width of the stroke using the text box. The default unit is pixels, but you can choose another unit with the drop-down list button.

Solid color / Pattern You can choose whether the line is drawn in the *Solid* or the *Pattern* style. Here, Solid and Pattern are distinct from the dash pattern. If you select a Solid line with no dash pattern, an unbroken line is drawn in the foreground color set in the Toolbox. If you select a Patterned line with no dash pattern, an unbroken line is drawn with the pattern set in the Toolbox. If you select a line with a dash pattern, the color or pattern is still determined by the foreground color or pattern set in the Toolbox. That is, if you select a marbled pattern and Patterned, dashed lines, the dashes are drawn in the marbled pattern

Line Style This drop-list brings some detailed options :

- **Cap Style** : You can choose the shape of the ends of an unclosed path, which can be *Butt*, *Round* or *Square*.
- **Join Style** : You can choose the shape of the path corners by clicking on *Miter*, *Round* or *Bevel*.
- **Miter limit** : When two segments of a path come together, the mitering of the corner is determined by the Miter Limit. If the strokes were wide, and no mitering were done, there would be pointed ends sticking out at the corner. The Miter Limit setting determines how the gap, formed when the outer edges of the two lines are extended, will be filled. You can set it to a value between 0.0 and 100.0, by using the slider or the associated text box and its arrows.

Figure 16.24 Example of miter limit*Left: Limit=0; Right: Limit=5;*

- **Dash Pattern** : On the pixel level, a dashed line is drawn as a series of tiny boxes. You can modify the pattern of these boxes. The black area with thin vertical lines represents the pixels of the dash. If you click on a black pixel, you remove it from the dash. If you click on a white pixel, you add it to the dash. The gray areas indicate how the pattern will be repeated when a dashed line is drawn.
- **Dash Preset** : Instead of making your own dash pattern, you can choose one from the drop-down box. This pattern will then be displayed in the Dash pattern area, so you can get an idea of how it will look.
- **Anti-aliasing** : Curved strokes or strokes drawn at an angle may look jagged or stair-stepped. The anti-aliasing option smooths them out.

Stroking with a Paint Tool

Paint Tool You can select a paint tool to use to draw the stroke from the drop-down box. If you do that, the currently-selected options of the paint tool are used, rather than the settings in the dialog.

Emulate Brush Dynamics See [Brush Dynamics](#).

16.3.22 The “Preferences” Command

This command displays the [Preferences dialog](#), which lets you alter a variety of settings that affect the look, feel, and performance of the GIMP.

16.3.22.1 Activate Command

You can access this command in the image menu bar through Edit → Preferences

16.3.23 Keyboard Shortcuts

How to use this command is described in [Section 12.5](#).

16.3.23.1 Activate the Command

You can access this command from the image menubar through Edit → Keyboard Shortcuts....

16.3.24 Modules

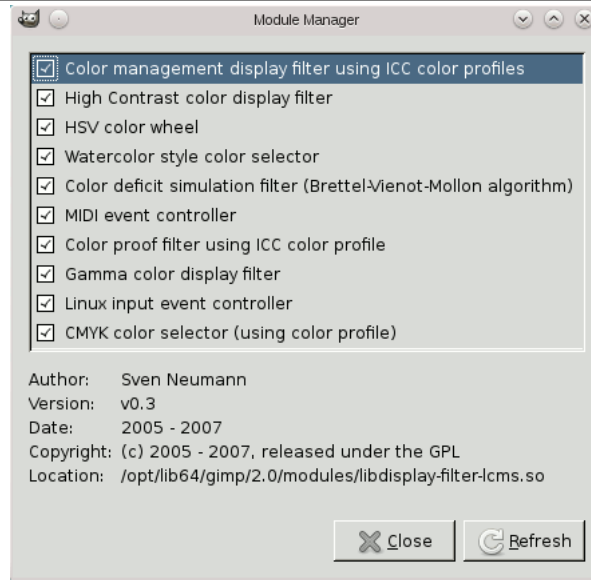
With the Modules command, you can show the various extension modules which are available and control which of them should be loaded. Modules perform functions such as choosing colors and display filtering. Any changes you make to the settings with the Module Manager command will take effect the next time you start GIMP. These changes affect GIMP’s functional capabilities, its size in memory and its start-up time.

16.3.24.1 Activating the Command

You can access this command from the image menubar through Edit → Modules

16.3.24.2 Description of the "Module Manager" Dialog

Figure 16.25 The "Module Manager" dialog window

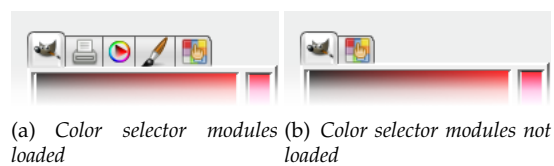


The window of the Module Manager shows the loadable modules.

Clicking on the boxes in the first column of the modules list will check or uncheck the modules. The next time you start GIMP, any checked module will be loaded.

You will notice the difference only when you try to use the modules. For example, there are several **color selectors** to select the foreground or background color. Some of these selectors are modules and will only be available when you check the respective option in the module manager:

Figure 16.26 Loaded modules example: Color selector modules



For loaded modules, information about the selected module is displayed at the bottom of the dialog.

In the second column, for each loaded module the purpose of the module is shown. For any module, that is not loaded, the directory path of this module is shown.

When you click on the Refresh button, the list of modules will be updated: modules no longer on disk will be removed, and new modules found will be added.

16.3.25 Units

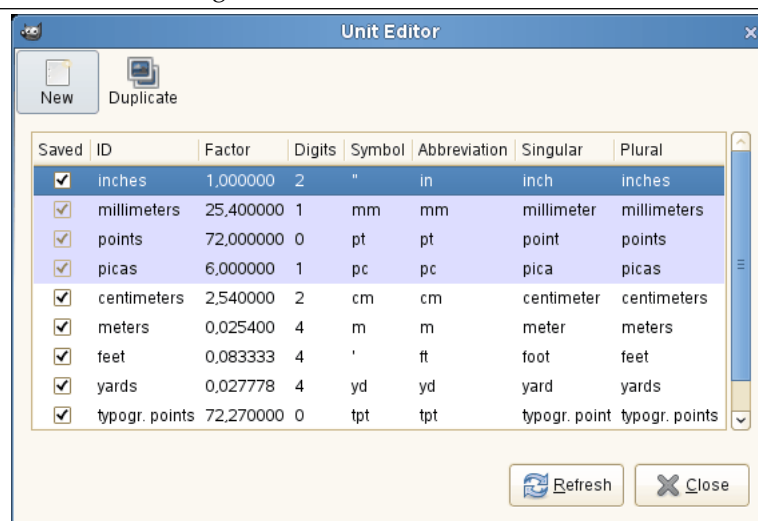
The Units command displays a dialog which shows information about the units of measurement that are currently being used by GIMP. It also allows you to create new units which can be used by GIMP in a variety of situations.

16.3.25.1 Activate the Command

You can access this command from the image menubar through Edit → Units.

16.3.25.2 Description of the “Unit Editor” dialog window

Figure 16.27 The “Unit Editor” dialog window



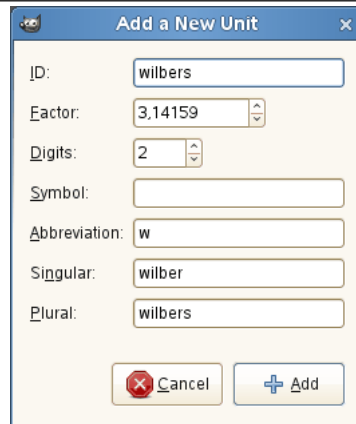
The figure above shows the “Unit Editor” dialog window. The list shows the units of measurement which are currently defined. You can click on the New button or the Duplicate button to create a new measurement unit, as described below.

Description of the list elements

- *Saved*: If this column is checked, a unit definition will be saved when GIMP exits. Some units are always kept, even if they are not marked with a check. These are highlighted in the list.
- *ID*: The string GIMP uses to identify the unit in its configuration files.
- *Factor*: How many units make up an inch.
- *Digits*: This field is a hint for numerical input fields. It specifies how many decimal digits the input field should provide to get approximately the same accuracy as an “inch” input field with two decimal digits.
- *Symbol*: The unit’s symbol if it has one (e.g. “” for inches). The unit’s abbreviation is used if doesn’t have a symbol.
- *Abbreviation*: The unit’s abbreviation (e.g. “cm” for centimeters).
- *Singular*: The unit’s singular form, which GIMP can use to display messages about the unit.
- *Plural*: The unit’s plural form, which GIMP can use to display messages about the unit.

16.3.25.3 Defining New Units

Figure 16.28 The “New Unit” dialog



Adding the new unit “wilbers”

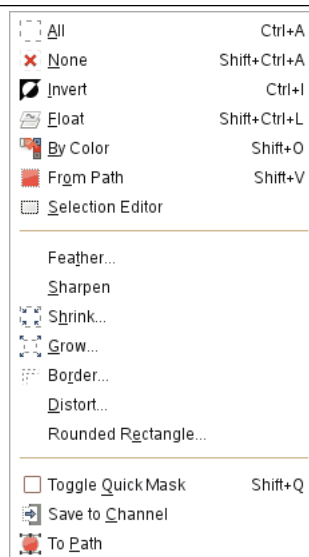
You can display the dialog shown above by clicking on either the New button or the Duplicate button on the Unit Editor dialog. The input fields on the dialog are described above.

If you click on the New button, most input fields are empty. If you click on the Duplicate button, the values initially displayed in the input fields of the dialog are the values of the unit you have currently selected in the Unit Editor dialog. You can then edit the values to create your new unit.

16.4 The “Select” Menu

16.4.1 Introduction to the “Select” Menu

Figure 16.29 The Contents of the “Select” menu



This section explains the commands on the Select menu of the image menubar.


Note

Besides the commands described here, you may also find other entries in the menu. They are not part of GIMP itself, but have been added by extensions (plug-ins). You can find information about the functionality of a Plugin by referring to its documentation.

16.4.2 Select All

The Select All command creates a new selection which contains everything on the current layer.


16.4.2.1 Activate the Command

- You can access this command from the image menubar through Select → All,
- or by using the keyboard shortcut Ctrl-A.
- In addition, at the **Selection Editor**, you can access it through the **Tab menu**: Selection Editor Menu → All, or by clicking on the  icon button on the bottom of this dialog.

16.4.3 None

The None command cancels all selections in the image. If there are no selections, the command doesn't do anything. Floating selections are not affected.

16.4.3.1 Activating the Command

- You can access this command from the image menubar through Select → None.
- You can also use the keyboard shortcut Shift-Ctrl-A.
- In addition, at the **Selection Editor**, you can access it through the **Tab menu**: Selection Editor Menu → None, or by clicking on the  icon button on the bottom of this dialog.

16.4.4 Invert

The Invert command inverts the selection in the current layer. That means that all of the layer contents which were previously outside of the selection are now inside it, and vice versa. If there was no selection before, the command selects the entire layer.

Warning

Do not confuse this command with the **Invert colors** command.

16.4.4.1 Activate the Command

- You can access this command from the image menubar through Select → Invert.
- You can also use the keyboard shortcut Ctrl-I,
- or click on the corresponding icon in the **Selection Editor**

16.4.5 Float

The Float command converts a normal selection into a “floating selection”.

A floating selection (sometimes called a “floating layer”) is a type of temporary layer which is similar in function to a normal layer, except that before you can resume working on any other layers in the image, a floating selection must be *anchored*. That is, you have to attach it to a normal (non-floating) layer, usually the original layer (the one which was active previously), for instance, by clicking on the image outside of the floating selection (see below).

Important



You cannot perform any operations on other layers while the image has a floating selection!

You can use various operations to change the image data on the floating selection. There can only be one floating selection in an image at a time.

Tip



If you display the layer boundary by using the **Show Layer Boundary** command, you may have difficulty selecting a precise area of the image which you want in a layer. To avoid this problem, you can make a rectangular selection, transform it into a floating selection and anchor it to a new layer. Then simply remove the original layer.

In early versions of GIMP, floating selections were used for performing operations on a limited part of an image. You can do that more easily now with layers, but you can still use this way of working with images.

16.4.5.1 Activate the Command

- You can access this command from the image menubar through Select → Float,
- or by using the keyboard shortcut Shift-Ctrl-L.

16.4.5.2 Creating a Floating Selection Automatically


Some image operations create a floating selection automatically:

- The “paste” operations, **Paste Named Buffer**, **Paste** or **Paste Into**, also create a floating selection.
- In addition, the Transform tools, **Flip**, **Shear**, **Scale**, **Rotate** and **Perspective**, create a floating selection when they are used on a selection, rather than a layer. When the Affect mode is *Transform Layer* and a selection already exists, these tools transform the selection and create a floating selection with the result. If a selection does not exist, they transform the current layer and do not create a floating selection. (If the Affect mode is *Transform Selection*, they also do not create a floating selection.)
- By click-and-dragging a selection while pressing the Ctrl-Alt keys (see Section 7.2.1) you also automatically create a floating selection.

16.4.5.3 Anchor a Floating Selection

You can anchor a floating selection in various ways:

- You can anchor the floating selection to the current layer the selection is originating from. To do this, click anywhere on the image except on the floating selection. This merges the floating selection with the current layer.

- Or you can use the **Anchor layer** command (Ctrl-H).
- You can also anchor the floating selection to the current layer by clicking on the anchor button  of the **Layers dialog**, that appears, since GIMP-2.10.18, when the floating selection is created, instead of the default Merge layers icon.
- If you create a **New Layer** while there is a floating selection, the floating selection is anchored to this newly created layer.

16.4.6 By Color

The Select By Color command is an alternate way of accessing the “Select By Color” tool, one of the basic selection tools. You can find more information about using this tool in [Select By Color](#).


16.4.6.1 Activating the Command

- You can access this command from the image menubar through Select → By Color,
- or by using the keyboard shortcut Shift-O.

16.4.7 From Path

The From Path command transforms the current path into a selection. If the path is not closed, the command connects the two end points with a straight line. The original path is unchanged.

16.4.7.1 Activating the Command

- You can access this command from the image menubar through Select → From Path.
- In addition, you can click on the Path to Selection button  in the Path dialog to access the command.
- You can also use the keyboard shortcut Shift-V.

16.4.8 Selection Editor

The Selection Editor command displays the “Selection Editor” dialog window. This dialog window displays the active selection in the current image and gives you easy access to the selection-related commands. It is not really intended for editing selections directly, but if you are working on a selection, it is handy to have the selection commands all together, since it is easier to click on a button than to search for commands in the command tree of the menubar. The “Selection Editor” also offers some advanced options for the “Select to Path” command.

16.4.8.1 Activating the Command







You can access this command from the image menubar through Select → Selection Editor.

16.4.8.2 Description of the "Selection Editor" dialog window

Figure 16.30 The "Selection Editor" dialog window

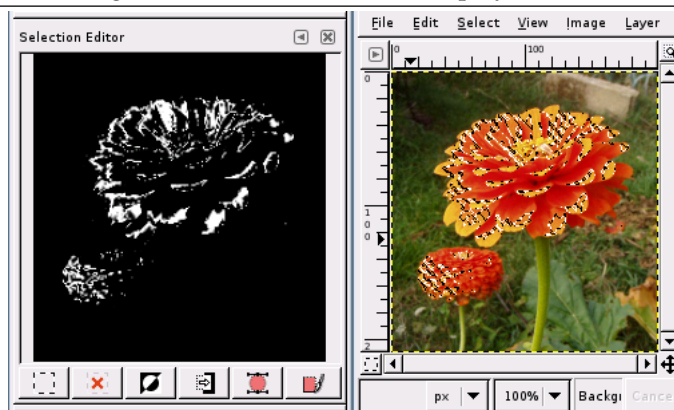


The Buttons The "Selection Editor" dialog window has several buttons which you can use to easily access selection commands:

-  The **Select All** button.
-  The **Select None** button.
-  The **Select Invert** button.
-  The **Save to Channel** button.
-  The **To Path** button. If you hold the **Shift** key while clicking on this button, the "Advanced Settings" dialog is displayed. Please see the next section for details about these options.
-  The **Stroke Selection** button.

The display window In the display window, selected areas of the image are white, non-selected areas are black, and partially selected areas are in shades of gray. Clicking in this window acts like **Select by Color**. See the example below.

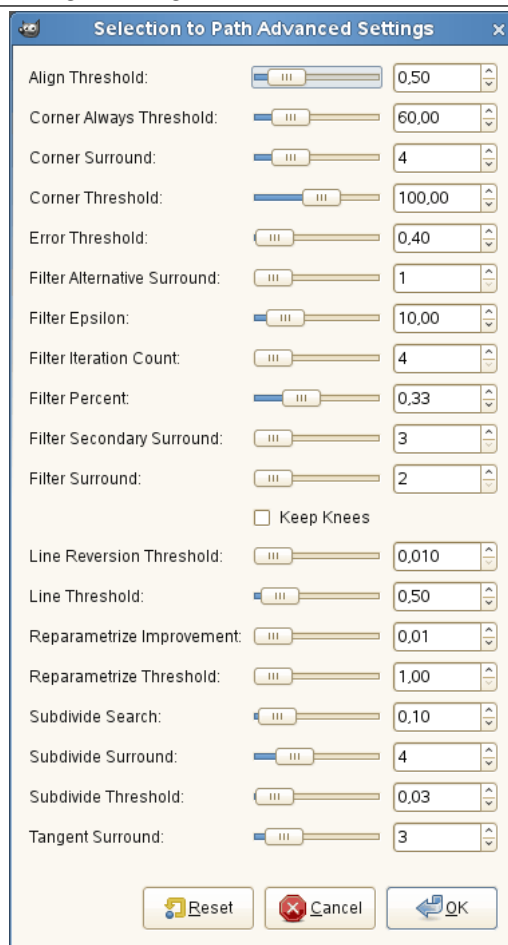
Figure 16.31 Example of clicking in the "Selection Editor" display window



Clicking in the "Selection Editor" display window to "Select By Color". Note that this figure could just as well show the appearance of the "Selection Editor" display window when "Select By Color" is used in the image window.

16.4.8.3 The “Selection to Path Advanced Settings” dialog

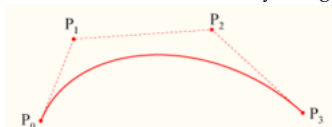
Figure 16.32 The “Advanced Settings” dialog window



The “Selection to Path Advanced Settings” dialog, that you get by **Shift** clicking on the Selection to Path button, contains a number of options, most of which you can set with either a slider bar or a text box. There is also one check box. These options are mostly used by advanced users. They are:

- *Align Threshold*: If two endpoints are closer than this value, they are made to be equal.
- *Corner Always Threshold*: If the angle defined by a point and its predecessors and successors is smaller than this, it is a corner, even if it is within *Corner Surround* pixels of a point with a smaller angle.
- *Corner Surround*: Number of points to consider when determining if a point is a corner or not.
- *Corner Threshold*: If a point, its predecessors, and its successors define an angle smaller than this, it is a corner.
- *Error Threshold*: Amount of error at which a fitted spline¹ is unacceptable. If any pixel is further away than this from the fitted curve, the algorithm tries again.
- *Filter Alternative Surround*: A second number of adjacent points to consider when filtering.

¹“Spline” is a mathematical term for a function which defines a curve by using a series of control points, such as a Bézier curve.



See Wikipedia for more information.

- *Filter Epsilon*: If the angles between the vectors produced by *Filter Surround* and *Filter Alternative Surround* points differ by more than this, use the one from *Filter Alternative Surround*.
- *Filter Iteration Count*: The number of times to smooth the original data points. Increasing this number dramatically, to 50 or so, can produce vastly better results. But if any points that “should” be corners aren’t found, the curve goes wild around that point.
- *Filter Percent*: To produce the new point, use the old point plus this times the neighbors.
- *Filter Secondary Surround*: Number of adjacent points to consider if *Filter Surround* points defines a straight line.
- *Filter Surround*: Number of adjacent points to consider when filtering.
- *Keep Knees*: This check box says whether or not to remove “knee” points after finding the outline.
- *Line Reversion Threshold*: If a spline is closer to a straight line than this value, it remains a straight line, even if it would otherwise be changed back to a curve. This is weighted by the square of the curve length, to make shorter curves more likely to be reverted.
- *Line Threshold*: How many pixels (on the average) a spline can diverge from the line determined by its endpoints before it is changed to a straight line.
- *Reparameterize Improvement*: If reparameterization doesn’t improve the fit by this much percent, the algorithm stops doing it.
- *Reparameterize Threshold*: Amount of error at which it is pointless to reparameterize. This happens, for example, when the algorithm is trying to fit the outline of the outside of an “O” with a single spline. The initial fit is not good enough for the Newton-Raphson iteration to improve it. It may be that it would be better to detect the cases where the algorithm didn’t find any corners.
- *Subdivide Search*: Percentage of the curve away from the worst point to look for a better place to subdivide.
- *Subdivide Surround*: Number of points to consider when deciding whether a given point is a better place to subdivide.
- *Subdivide Threshold*: How many pixels a point can diverge from a straight line and still be considered a better place to subdivide.
- *Tangent Surround*: Number of points to look at on either side of a point when computing the approximation to the tangent at that point.

16.4.9 Feather

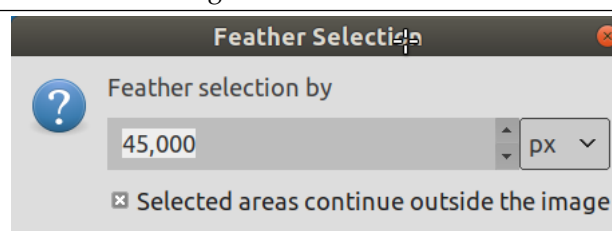
The Feather command feathers the edges of the selection. This creates a smooth transition between the selection and its surroundings. You normally feather selection borders with the “Feather Edges” option of the selection tools, but you may feather them again with this command.

16.4.9.1 Activating the Command

You can access this command from the image menubar through Select → Feather.

16.4.9.2 Description of the “Feather Selection” dialog window

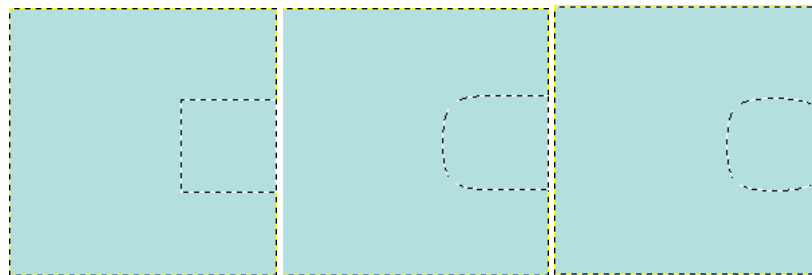
Figure 16.33 The “Feather Selection” dialog



Feather selection by Enter the width of the selection border feathering. The default units are pixels, but you can also choose other units with the drop-down menu.

Selected area continue outside image If the selection is on border of the image (or goes beyond the border), this option acts as if the selected area continued outside the image.

Figure 16.34 Example



(a) Original. Selection on border. (b) Option checked. The right border is not feathered. (c) Option unchecked

16.4.10 Sharpen

The Sharpen command reduces the amount of blur or fuzziness around the edge of a selection. It reverses the effect of the **Feather Selection** command. The new edge of the selection follows the dotted line of the edge of the old selection. Anti-aliasing is also removed.

Note



Please do not confuse this command with the **Sharpen (Unsharp Mask)** filter.

16.4.10.1 Activating the Command

You can access this command from the image menubar through Select → Sharpen.

16.4.11 Shrink

The Shrink command reduces the size of the selected area by moving each point on the edge of the selection a certain distance further away from the nearest edge of the image (toward the center of the selection). Feathering is preserved, but the shape of the feathering may be altered at the corners or at points of sharp curvature.

16.4.11.1 Activating the Command

You can access this command from the image menubar through Select → Shrink...

16.4.11.2 Description of the "Shrink" dialog

Figure 16.35 The "Shrink Selection" dialog



Shrink selection by Enter the amount by which to reduce the selection in the text box. The default unit is pixels, but you can choose a different unit of measurement from the drop-down menu.

Selected area continue outside image Was "Shrink from image border"; the action is unchanged. This option is only of interest if the selection runs along the edge of the image. If it does and this option is checked, then the selection shrinks away from the edge of the image. If this option is not checked, the selection continues to extend to the image border. See [Selected area continue outside image](#).

16.4.12 Grow

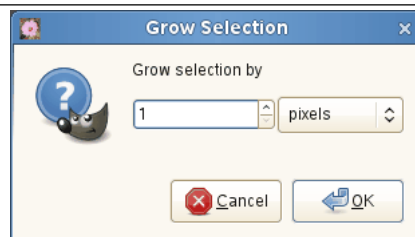
The Grow command increases the size of a selection in the current image. It works in a similar way to the [Shrink](#) command, which reduces the size of a selection.

16.4.12.1 Activating the Command

You can access this command from the image menubar through Select → Grow.

16.4.12.2 Description of the "Grow Selection" dialog

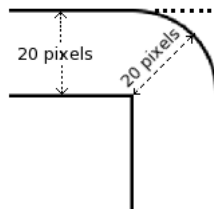
Figure 16.36 The "Grow Selection" dialog window



Grow selection by You can enter the amount by which to increase the selection in the text box. The default unit of measurement is pixels, but you can choose a different unit by using the drop-down menu.

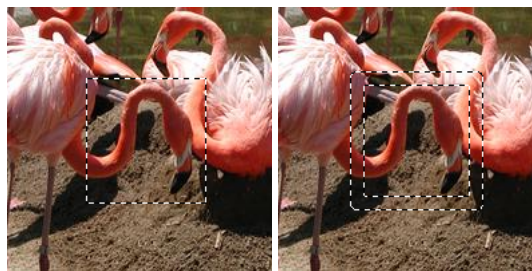
16.4.12.3 A Peculiarity of Rectangular Selections

When you grow a rectangular selection, the resulting selection has rounded corners. The reason for this is shown in the image below:

Figure 16.37 Why growing a rectangular selection results in rounded corners

If you do not want rounded corners, you can use the **Rounded Rectangle** command with a 0% radius.

16.4.13 Border

Figure 16.38 Example of creating a border from a selection

(a) An image with a selection (b) After "Select Border"

The Select Border command creates a new selection along the edge of an existing selection in the current image. The edge of the current selection is used as a form and the new selection is then created around it. You enter the width of the border, in pixels or some other unit, in the dialog window. Half of the new border lies inside of the selected area and half outside of it.

16.4.13.1 Activating the Command

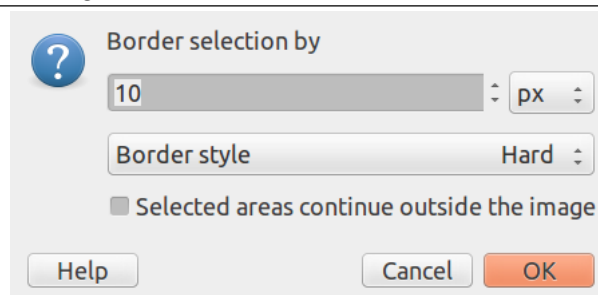
You can access this command from the image menubar through Select → Border....

This command is grayed out, inactive, if there is no selection.

Two conditions must be respected to use this command:

- The image must have an alpha channel.
- The original image must be created with the "Antialiasing" option checked in the selection tool that is used.

16.4.13.2 Description of the "Border" dialog window

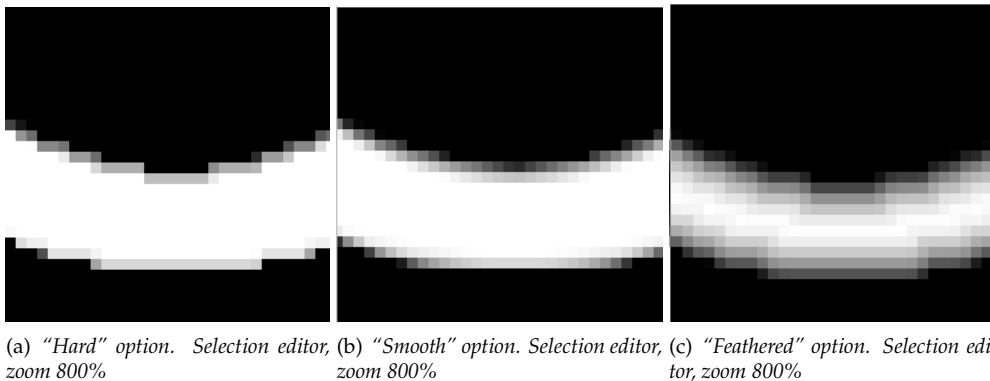
Figure 16.39 The "Border" dialog window

Border selection by Enter the width of the border selection in the box. The default units are pixels, but you can also choose the units with the drop-down menu.

Border Style

- **Hard:** this option does not keep antialiasing. This can be useful in some cases.
- **Smooth:** this option keeps antialiasing. Note that "Smooth" does not create any antialiasing. That's why antialiasing must be added when creating the original selection. This option is the best one.
- **Feathered:** this option does the same things as "Hard", but instead of the resulting border being fully selected, it fades outwards. The result is not very good; if you want a feathered border, better is use one of the other modes, and then feather the result. It's there for history reason.

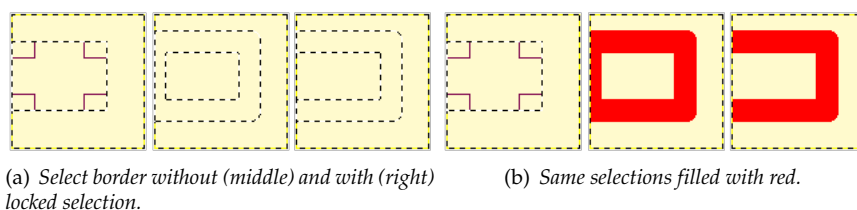
Figure 16.40 Border Style Comparison



Selected areas continue outside the image This option was "Lock selection to image edges". Its function is unchanged.

With this option enabled, an edge of an (usually rectangle) selection remains unchanged if it is aligned with an edge of the image; no new selection will be created around it.

Figure 16.41 Select border with and without "Selected areas continue outside the image"



16.4.14 Remove Holes

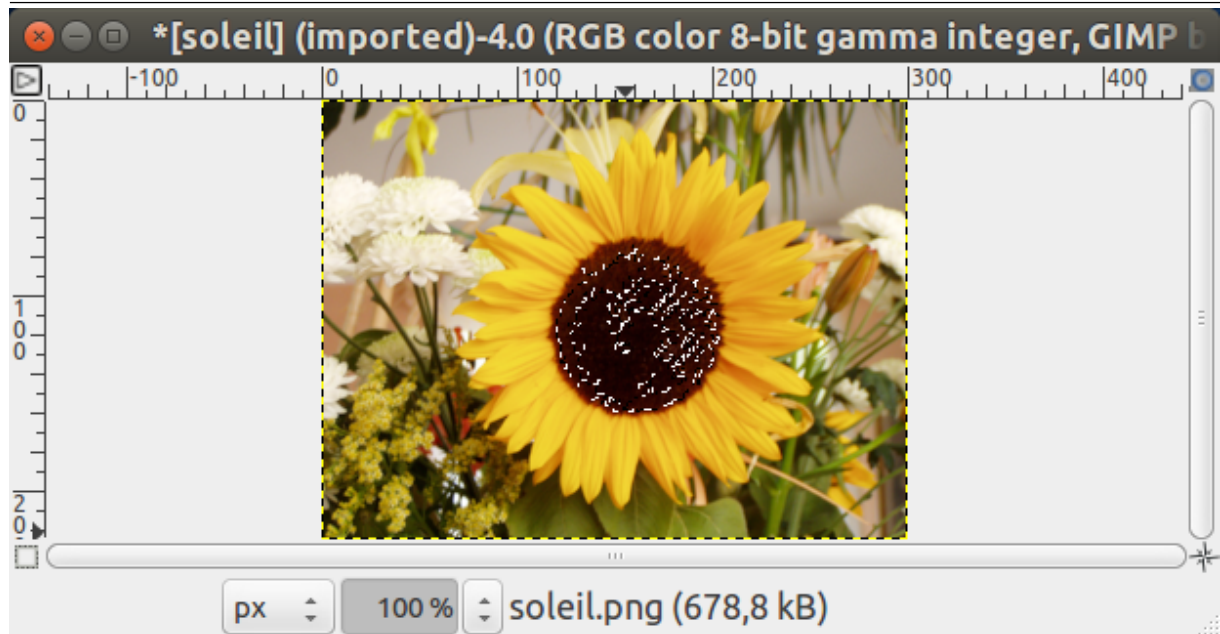
This command removes the holes of a selection. Holes are unselected or partially selected areas in the selection.

16.4.14.1 Activating the Command

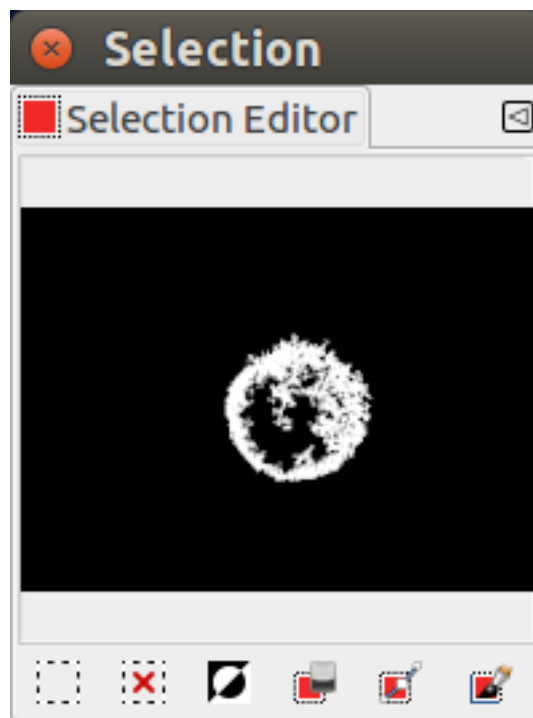
You can access this command from the image menubar through Select → Remove Holes.

16.4.14.2 Example for Remove Holes

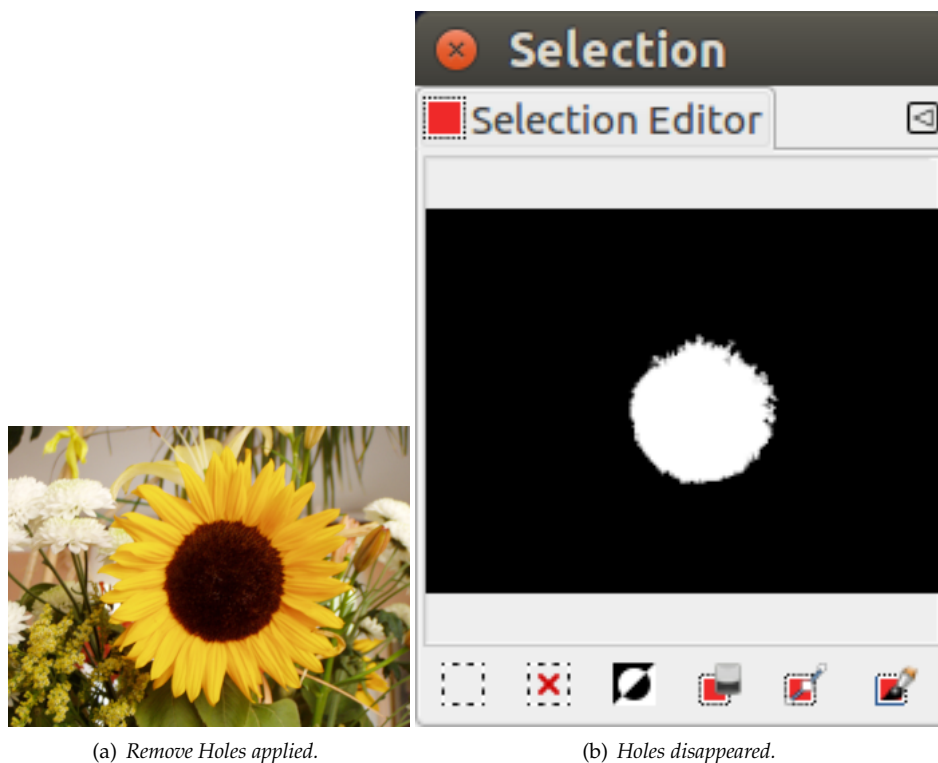
Figure 16.42 A selection and the Selection Editor



(a) Selection using the Fuzzy Select tool.



(b) The Selection Editor shows several holes.

Figure 16.43 Remove Holes applied and the Selection Editor(a) *Remove Holes applied.*(b) *Holes disappeared.*

16.4.15 Distort

Figure 16.44 Example of using Distort on a selection(a) *An image with a selection*(b) *After "Distort"*

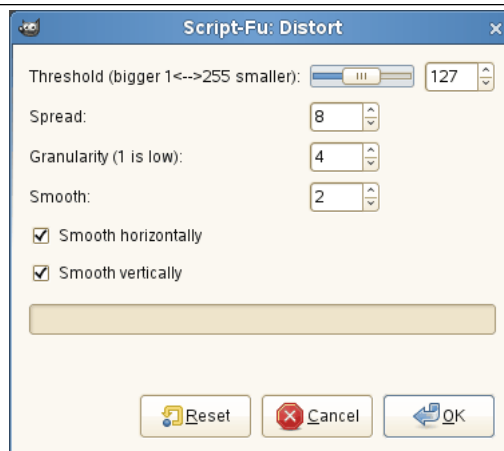
The "Distort" command deforms the selection contour.

16.4.15.1 Activating the Command

You can access this command from the image menu bar through Select → Distort....

16.4.15.2 Description of the "Distort" Dialog Window

Figure 16.45 The "Distort" dialog



This command has several options which allow to increase or reduce the deformation. It is not possible to foresee the result and you have to experiment.

Threshold A higher threshold shrinks the distorted selection. A lower threshold makes the selection bigger.

If the active selection has a regular shape (e.g. rectangle or ellipse selection), this option controls if the new outline is more inside the original selection or more outside the original selection.

Spread A higher "Spread" increases the deformation.

Granularity A higher "Granularity" increases the deformation.

Smooth A higher "Smooth" decreases the deformation.

Deactivating Smooth horizontally or Smooth vertically increases the deformation.

16.4.16 Rounded Rectangle

Figure 16.46 Example of using Rounded rectangle on a selection



(a) An image with a selection (b) After "Rounded rectangle"

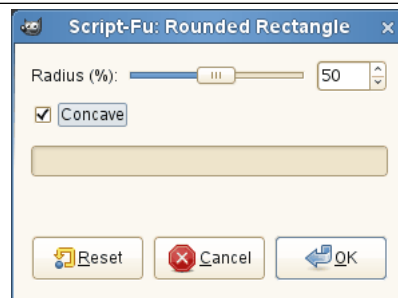
The "Rounded Rectangle" Script-Fu command converts an existing selection (rectangular, elliptical or other shape) into a rectangular selection with rounded corners. The corners can be curved toward the inside (concave) or toward the outside (convex). To do this, the command adds or removes circles at the corners of the selection.

16.4.16.1 Activating the Command

You can access this command from the image menu bar through Select → Rounded Rectangle....

16.4.16.2 Description of the "Rounded Rectangle" Dialog Window

Figure 16.47 The "Rounded Rectangle" dialog



Radius (%) You can enter the radius of the rounded corner in percent by using a slider or a text field. This value is a percentage of the height or the width, whichever is less.

Concave If you check this box, the corners will be concave (curving toward the inside), rather than convex (curving toward the outside).

16.4.17 Toggle QuickMask

This command has the same action as clicking on the small button in the bottom left corner of the image. See [Quick Mask](#)

16.4.17.1 Activate Dialog

- You can access this command through Select → Toggle QuickMask.
- Default shortcut is Shift-Q

16.4.18 Save to Channel

The Save to Channel command saves the selection as a channel. The channel can then be used as a channel selection mask. You can find more information about them in the [Channel Dialog](#) section.

16.4.18.1 Activate the Command

- You can access this command from the image menubar through Select → Save to Channel.
- You can also access it from the [Selection Editor](#).

16.4.19 To Path

The To Path command converts a selection into a path. The image does not seem to change, but you can see the new path in the [Paths Dialog](#). By using the [Path tool](#) in the Toolbox, you can precisely adapt the outline of the selection. You can find further information regarding paths in the [Paths dialog](#) section.

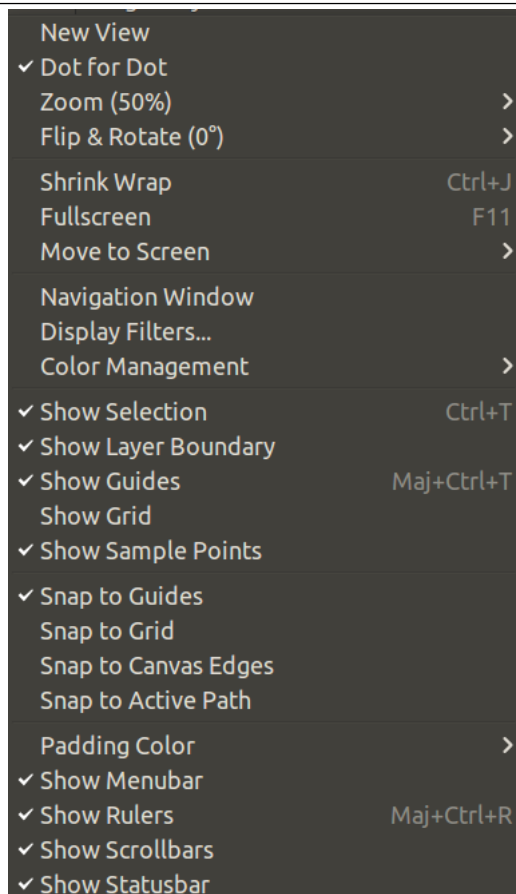
16.4.19.1 Activating the Command

- You can access this command from the image menu bar through Select → To Path.
- You can also access it from the [Selection Editor](#) or from the [Paths Dialog](#) which offers you a lot of [Advanced Options](#).

16.5 The “View” Menu

16.5.1 Introduction to the “View” Menu

Figure 16.48 Contents of the View menu



This section describes the View menu, which contains commands that affect the visibility or appearance of the image and various elements of the interface.

Note



Besides the commands described here, you may also find other entries in the menu. They are not part of GIMP itself, but have been added by extensions (plug-ins). You can find information about the functionality of a Plugin by referring to its documentation.

16.5.2 New View

The New View command creates a new image window for the current image, which you can set up differently from the existing display. You can create multiple views of any image, which are numbered .1, .2, etc., but only the zoom factor and other viewing options may be different. Any changes, other than viewing changes, which you make in one window also appear in the other displays which show the same image. The new views are not separate image files; they are simply different aspects of the same image. You might use multiple views, for example, if you were working on individual pixels at a high zoom factor. You could then see the effects your changes would have on the image at a normal size.

16.5.2.1 Activating the Command

- You can access this command from the image menubar through View → New View.

16.5.3 Show All

The Show All command appeared in GIMP-2.10.14. It makes visible all pixels that are spilling off the canvas boundary and that are normally cut off the image. This allow you to drag new layers, new images outside the canvas temporarily to work with them.

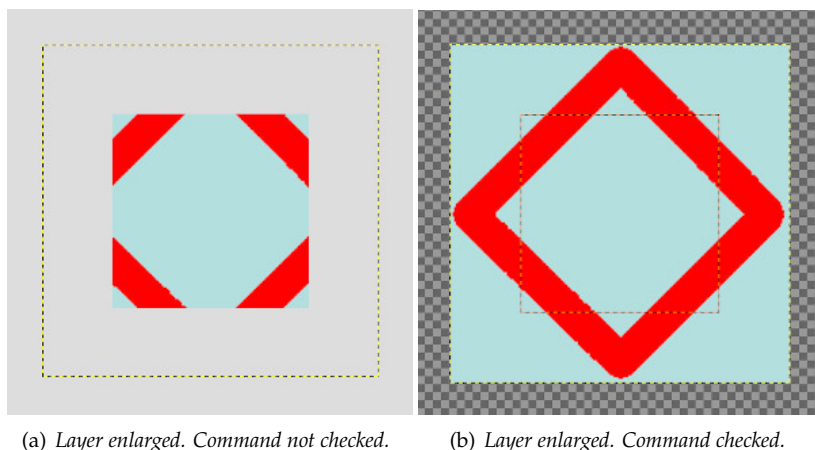
16.5.3.1 Activating the Command

You can access this command from the image menubar through View → Show All,

16.5.3.2 Basic principles about the "Show All" Command

When you just open an image, the canvas size is the same as the image size, and applying the "Show all" command, of course, gives nothing since there is no pixel outside the canvas. So, enlarge the layer using the [Scale tool](#).

Figure 16.49 Show All



(a) Layer enlarged. Command not checked.

(b) Layer enlarged. Command checked.

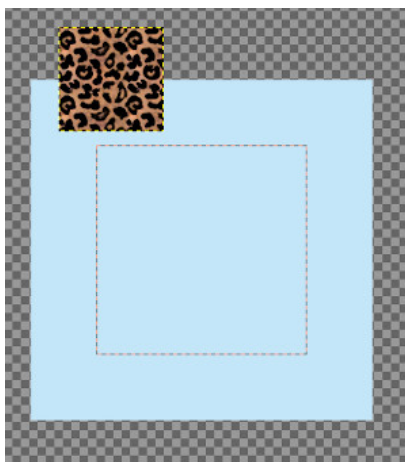
When the "Show all" command is unchecked, pixels spilling off the canvas boundary are not visible. When the command is checked, all pixels outside the canvas are visible (if the layer size is enough). You can see:

- The canvas boundary as a *red dotted line*. You can paint outside the canvas, in the limit of the layer. Changes made outside the canvas are not exported with the image, unless you enlarge the canvas size using [Canvas Size](#).
- The layer boundary as a *yellow dotted line*.
- A large *checkerboard area* indicating there is no pixel. The checkerboard area is infinite: whatever the image window size, it persists.

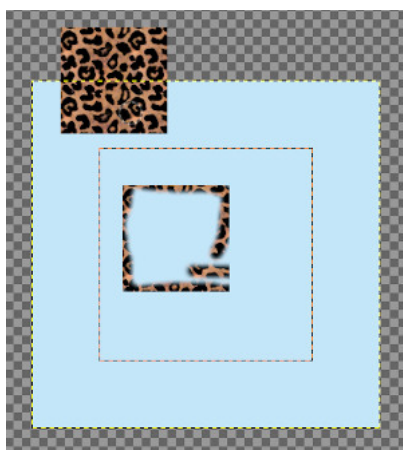
16.5.3.3 Using the "Show All" command

We will clone from a new image onto the image.

- Open your image, check "Show All", and enlarge layer.
- Open the new image. A new layer is created for this new image. Click and drag this new layer onto your image. Use Move tool to put the new image outside canvas.



- Make new layer active. Use Clone tool and **Ctrl**-click on the new image to make it the source.
- Make image layer active. Paint on your image to clone the source. You see that pixels in checkerboard area are cloned.



16.5.4 Dot for Dot

The Dot for Dot command enables and disables "Dot for Dot" mode. If it is enabled (checked) and the zoom factor is 100%, every pixel in the image is displayed as one pixel on the screen. If it is disabled, the image is displayed at its "real" size, the size it will have when it is printed.

The example below will illustrate this. Imagine the following image properties:

- Image size: 100x100 pixels
- Image resolution: 300 ppi (pixels per inch)
- Image displayed with Zoom=100%, "Dot for Dot" *enabled*:

100x100 pixels

- Image displayed with Zoom=100%, "Dot for Dot" *disabled*:

$100 \text{ pixels} \div 300 \text{ ppi} = 1/3 \text{ inch} \quad 0.85 \text{ cm}$

For Dot for Dot mode to work properly, the resolution of the image must be the same as the screen resolution in the **Preferences menu**.

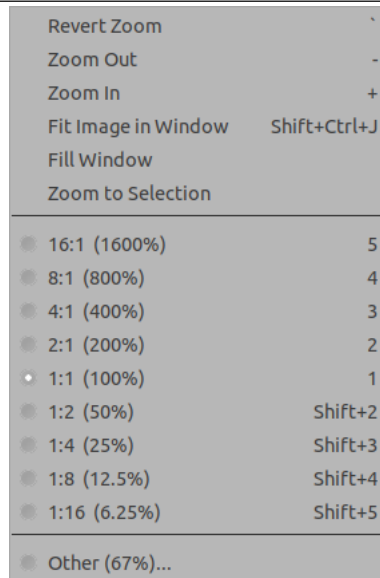
Enabling this mode is recommended if you are working on icons and web graphics. If you are working on images intended to be printed, you should disable Dot-for-Dot mode.

16.5.4.1 Activating the Command

- You can access this command from the image menubar through View → Dot for Dot.

16.5.5 Zoom

Figure 16.50 The “Zoom” submenu of the “View” menu



The Zoom submenu contains various commands which affect the magnification of the image in the image window (zooming). Enlarging an image (zooming in) is useful if you need to work with high precision, making pixel-level image modifications or precise selections. On the other hand, reducing an image (zooming out) is handy for getting an overall impression of the image and seeing the results of changes which affect the entire image. Please note that zooming is not undoable, since it does not affect the image data, only the way it is displayed.

Tip



Besides the entries in this submenu, there is also a zoom pull-down menu at the bottom edge of the image window (if the **status bar** is displayed), where several preset zoom levels are available.

You can also make settings regarding zooming in the **Navigation dialog**. You can also use the **Zoom** tool which lets you zoom a particular area of the image.

16.5.5.1 Activate the Submenu

- You can access this submenu from the image menubar through View → Zoom. Note that the “Zoom” label on the “View” menu shows the current zoom factor, for example, Zoom (100%).

16.5.5.2 Contents of the “Zoom” submenu

The various “Zoom” submenu commands are described below, along with their default keyboard shortcuts, if any.

Revert Zoom (Shortcut: [grave accent, “backtick”]) This command will reset the zoom factor to the previous value, which is also shown by this label, for example Revert Zoom (100%). If you never changed the zoom factor of the active image, this entry is insensitive and grayed out.

Zoom Out (Shortcut: -) Each time “Zoom Out” is used, the zoom factor is decreased by about 30%. There is a minimum zoom level of 0.39%.

Zoom In (Shortcut: +) Each time “Zoom In” is used, the zoom factor is increased by about 30%. The maximum possible zoom level is 25600%.

Note



The keyboard shortcut for “Zoom In” has been somewhat controversial because this is a very common operation and on English keyboards, the **Shift** key must be pressed to use it. (This is not the case for European keyboards.) If you would like to have a different keyboard shortcut, you can create a dynamic shortcut for it; see the help section for [User Interface Preferences](#) for instructions.

Fit Image in Window (Shortcut: Shift-Ctrl-J). This command zooms the image to be as large as possible, while still keeping it completely within the window. There will usually be padding on two sides of the image, but not on all four sides.

Fill Window This command zooms the image as large as possible without requiring any padding to be shown. This means that the image fits the window perfectly in one dimension, but usually extends beyond the window borders in the other dimension.

Zoom to Selection This command zooms the image so that the selection fits the smallest dimension of the image window.

A:B (X%) With these commands, you can select one of the pre-set zoom levels. Each of the menu labels gives a ratio, as well as a percentage value. Please note that each zoom pre-set has its own keyboard shortcut. The current zoom is marked with a large dot.

Other This command brings up a dialog which allows you to choose any zoom level you would like, within the range of 1:256 (0.39%) to 256:1 (25600%).

Tip

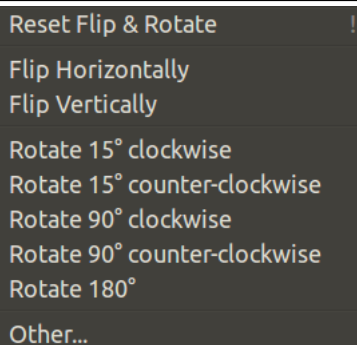


When you are working at the pixel level, you can use the [New view](#) command. This allows you to see what is happening to the image at its normal size at the same time.

16.5.6 Flip and Rotate (0°)

You can access this command from the image menubar through View → Flip and Rotate (0°), This command opens a submenu:

Figure 16.51 The “Flip and Rotate” submenu



These commands act on the view, not on the image. To act on the image, go to: Image Transform.

These commands are self-explanatory. Please note the “!” shortcut for the Reset Flip and Rotate command, which restores the image in its original state.

The Other... command opens a dialog that allows you to set a precise angle for the rotation of the view:

Figure 16.52 The “Select Rotation Angle” dialog

16.5.7 Shrink Wrap

The Shrink Wrap command resizes the window so that it is exactly the same size as the image at the current zoom factor. If the image doesn’t completely fit on the screen, the image window is enlarged so that the largest possible part of the image is shown. Please note that GIMP will do this automatically if you set the “Resize window on zoom” and “Resize window on image size change” options in the **Image Window** page of the Preferences dialog.

Note



Please note also that the behavior described here is not performed by GIMP itself, but by the “window manager”, a part of the operating system of your computer. For that reason, the functionality described may be different on your computer, or in the worst case, might not be available at all.

16.5.7.1 Activating the Command

- You can access this command from the image menubar through View → Shrink Wrap,
- or by using the keyboard shortcut Ctrl-J.

16.5.8 Full Screen

The Fullscreen command enables and disables displaying the image window on the entire screen. When it is enabled, the image window takes up the whole screen, but the image stays the same size. When you enable full-screen mode, the menubar may not be displayed, but if this happens, you can right-click on the image to access the image menu. You can set the default appearance for full-screen mode in the **Preferences** menu.

Pressing the **Tab** key toggles the visibility of all present docks.

Note



If you use GIMP on an Apple computer, full-screen mode may not work, since Apple doesn’t provide the necessary functionality. Instead, you can maximize the image window by clicking on the *Green Button*, so the image occupies most of the screen.


16.5.8.1 Activating the Command

- You can access this command from the image menubar through View → Full Screen,
- or by using the keyboard shortcut **F11**.
- In multi-window mode, you can also get it by double-clicking on the title bar of the image window.

16.5.9 Navigation Window

The Navigation Window command opens the **navigation window**. This allows you to easily navigate through the image, to set zoom levels and to move the visible parts of the image. You can find more information about using it in the **Navigation dialog** chapter.

16.5.9.1 Activating the Command

- You can access this command from the image menubar through View → Navigation Window,
- You can also access it more rapidly by clicking on the  icon in the lower right corner of the image window.

16.5.10 Display Filters

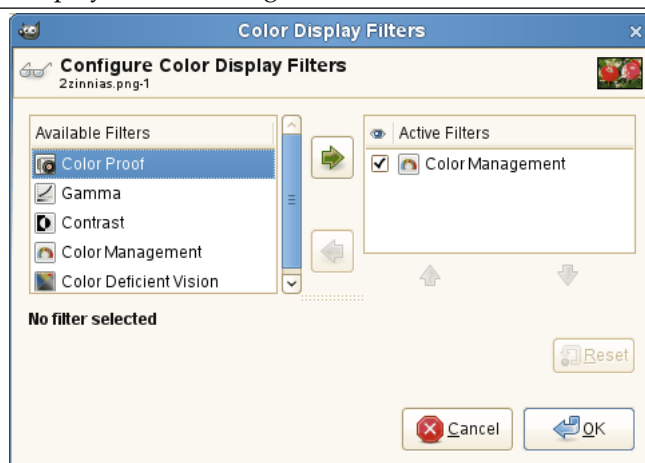
This command shows a dialog window when executed. This window can be used to manage the display filters and their options. Display filters are not to be confused with the filters in the filters-menu. Display filters do not alter the image data, but only one display of it. You can imagine display filters like big panes before your screen. They change your perception of the image. This can be useful for things like soft proofing prints, controlling the color management but also simulation of color deficient vision.

16.5.10.1 Activating the Command

You can access this command from the image menubar through View → Display Filters....

16.5.10.2 Description of the "Display Filters" Dialog

Figure 16.53 The "Color Display Filters" dialog



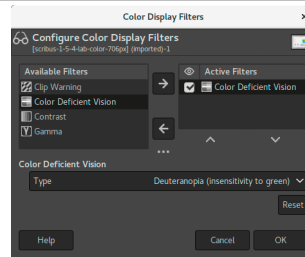
This dialog has two small selectboxes. The left selectbox displays the Available Filters. You can move a filter to the right selectbox by selecting it and clicking on the right arrow button. The Active Filters window on the right displays filters you have chosen and which will be applied if the adjacent box is checked. You can move filters from the right selectbox to the left selectbox by using the left arrow button. If you select a filter by clicking on its name, its options are displayed below the two selectboxes, in the Configure Selected Filter area.

- Simulation of deficient vision (Section 16.5.10.3; Section 16.5.10.5)
- Digital photography helper (Section 16.5.10.6)
- Others (Section 16.5.10.4)

16.5.10.3 Color Deficient Vision

The images you create, we hope, will be seen by many people on many different systems. The image which looks so wonderful on your screen may look somewhat different to people with sight deficiencies or on a screen with different settings from yours. Some information might not even be visible.

Figure 16.54 Description of the "Color Deficient Vision" dialog



16.5.10.3.1 Options

Color Deficiency Type In this drop-down menu you can select from among:

Protanopia² (insensitivity to red) Protanopia is a visual deficiency of the color red. It's the well-known daltonism (red-green color blindness). Daltonism occurs fairly frequently in the population.

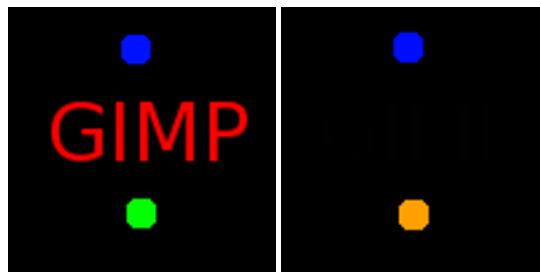
Protanopia is actually more complex than this; a person with this problem cannot see either red or green, although he is still sensitive to yellow and blue. In addition, he has a loss of luminance perception and the hues shift toward the short wavelengths.

Deuteranopia (insensitivity to green) With deuteranopia, the person has a deficiency in green vision. Deuteranopia is actually like protanopia, because the person has a loss of red and green perception, but he has no luminance loss or hue shift.

Tritanopia (insensitivity to blue) With tritanopia, the person is deficient in blue and yellow perception, although he is still sensitive to red and green. He lacks some perception of luminance, and the hues shift toward the long wavelengths.

16.5.10.3.2 Examples

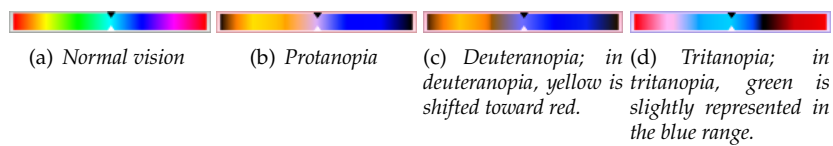
Figure 16.55 Example of protanopia



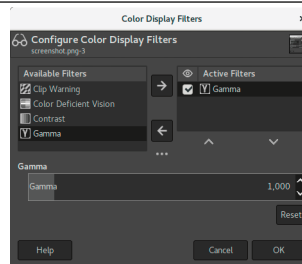
(a) Original image

(b) A red-blind person cannot see the red (255,0,0) text on a black (0,0,0) background.

²Greek: *proto*: first (color in the RGB Color System); *an*: negation; *op*: eye, vision.

Figure 16.56 Examples of the three types of vision deficiencies in one image

16.5.10.4 Gamma

Figure 16.57 The “Gamma” dialog

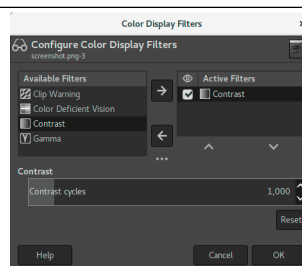
The correspondence between electrical intensity and color brightness is not exact and it depends upon the device (the camera, the scanner, the monitor, etc.). “Gamma” is a coefficient used to correct this correspondence. Your image must be visible in both dark and bright areas, even if it is displayed on a monitor with too much luminance or not enough. The “Gamma” Display Filter allows you to get an idea of the appearance of your image under these conditions.

Tip



In case you want not only to change the gamma of the current display, but the change the gamma within the image itself, you can find a description in Section 16.8.10.

16.5.10.5 Contrast

Figure 16.58 The “Contrast” dialog

Here, we are back in the medical domain. “Contrast Sensitivity” is the capacity of the visual system to distinguish slight differences in contrast. Some people with cataracts (which means that the lens has opaque crystals that scatter light over the retina) or retinal disease (for instance, due to diabetes, which destroys the rods and cones) have a deficiency in sensitivity to contrast: for example, they would have difficulties distinguishing spots on a dress.

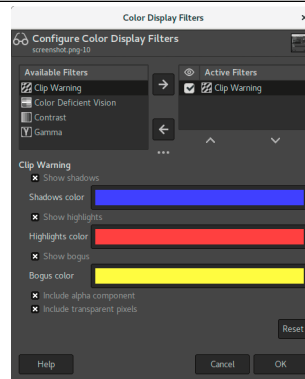
If you are interested in this subject, you can browse the Web for “contrast sensitivity”.

16.5.10.5.1 Options

Contrast Cycles With the “Contrast” Filter, you can see the image as if you were suffering from cataracts. You may have to increase the contrast of the image so that your grandmother can see it well. In most cases, only very low values of the Contrast Cycles parameter are of interest. Higher values create a side-effect which doesn’t interest us here: if you increase the luminosity value above 255, the complementary color appears.

16.5.10.6 Clip Warning

Figure 16.59 The “Clip Warning” dialog



This filter allows to visualize underexposed and overexposed areas of a photo with user-configurable colors. For now, it’s mostly geared towards images where colors are stored with floating point precision. You will mostly benefit from this, if you work on 16-/32-bit per channel float images such as EXR and TIFF.

16.5.10.6.1 Options

Show shadows Enable visualization for underexposed pixels (less than 0 in 32-bit float mode).

Shadows color User-configurable color that will be used to fill underexposed pixels.

Show highlights Enable visualization for overexposed pixels (more than 1 in 32-bit float mode).

Highlights color User-configurable color that will be used to fill overexposed pixels.

Show bogus Enable visualization for not-a-number (NaN) pixels, only visible when there is a division by zero error and suchlike.

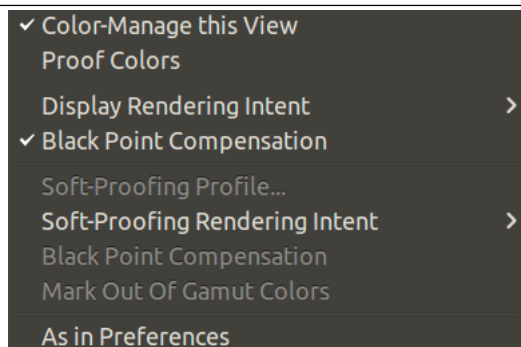
Bogus color User-configurable color that will be used to fill NaN pixels.

Include alpha component When enabled, include the alpha component in the warning.

Include transparent pixels When enabled, include fully transparent pixels in the warning.

16.5.11 Color Management

You can access this command from the image menubar through View → Color Management, This menu item opens a submenu allowing you to manage soft-proofing:

Figure 16.60 The “View/Color Management” submenu**Note**

There is also a Color Management menu item in the Image menu, related to color profile.

16.5.12 Show Selection

The Show Selection command enables and disables displaying the dotted line surrounding the selection in the image window. Please note that the selection still exists, even if displaying this line is disabled.

You can set the default for displaying the selection in the **Image Window Appearance** dialog.

16.5.12.1 Activating the Command

- You can access this command from the image menubar through View → Show Selection,
- or by using the keyboard shortcut Ctrl-T.

16.5.13 Show Layer Boundary

The Show Layer Boundary command enables and disables displaying the yellow dotted line that surrounds a layer in the image window. The dotted line is actually only visible when the layer is smaller than the image window. When the layer is the same size as the image window, the layer boundary is obscured by the image border.

You can set the default for the layer boundary in the **Image Window Appearance** dialog.

16.5.13.1 Activating the Command

- You can access this command from the image menubar through View → Show Layer Boundary.

16.5.14 Show Guides

The Show Guides command enables and disables displaying of **Guides** in the image window.

You can set the default for the guides in the **Image Window Appearance** dialog.

16.5.14.1 Activating the Command

- You can access this command from the image menubar through View → Show Guides,
- or by using the keyboard shortcut Shift-Ctrl-T.

16.5.15 Show Grid

By using the Show Grid command, you can enable and disable displaying the grid. When you enable it, the grid overlays the image and makes it easier for you to line up selected image elements.

You can set the default for the grid in the [Image Window Appearance](#) dialog.

Tip



See also the [Configure Grid](#) command and the [Snap to Grid](#) command.

16.5.15.1 Activating the Command

- You can access this command from the image menubar through View → Show Grid.

16.5.16 Show Sample Points

This command enables and disables showing the sample points in the image window. Sample points are used to display color information in the [sample points dialog](#).

16.5.16.1 Activating the Command

- You can access this command from the image menubar through View → Show Sample Points.

16.5.17 Snap to Guides

The Snap to Guides command enables and disables snap to guides. When snap to guides is enabled, the guides you set (see [Show Guides](#)) almost seems magnetic; when you move a layer or selection, the guides appear to pull on it when it approaches. This is enormously useful for accurate placement of image elements.

16.5.17.1 Activating the Command

- You can access this command from the image menubar through View → Snap to Guides.

16.5.18 Snap to Grid

The Snap to Grid command enables and disables snap to grid. When snap to grid is enabled, the grid you set (see [Show Grid](#)) almost seems magnetic; when you move a layer or selection, the grid points appear to pull on it when it approaches. This is enormously useful for accurate placement of image elements.

16.5.18.1 Activating the Command

- You can access this command from the image menubar through View → Snap to Grid.

16.5.19 Snap to Canvas

If this option is enabled, when you move a selection or a layer, they appear to pull on the canvas edges when it approaches. This is useful for accurate placement of image elements.

Note

Canvas edges are usually mingled with image edges: the canvas has, then, the same size as the image. But you can change canvas size in Image → Canvas Size.

16.5.19.1 Activating the Command

- You can access this command from the image menubar through View → Snap to Canvas.

16.5.20 Snap to Active Path

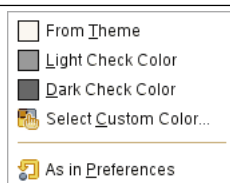
If this option is enabled, when you move a selection or a layer, they appear to pull on the next anchor point of the active path when it approaches. This is useful for accurate placement of image elements.

16.5.20.1 Activating the Command

- You can access this command from the image menubar through View → Snap to Path.

16.5.21 Padding Color

Figure 16.61 Contents of the “Padding Color” submenu



You can change the color of the canvas which surrounds the image by using the Padding Color command. The canvas is the surface the image lies on. It looks like a frame around the image in the image window. This is just a matter of personal preference, since the padding color does not have any effect on the image itself. Please note that this color is not the same as the color used by the Fill tool.

16.5.21.1 Activating the submenu

- You can access this submenu from the image menubar through View → Padding Color.

16.5.21.2 “Padding Color” Options

From Theme The color of the theme defined in [Preferences Theme](#) is used.

Light/Dark Check Color The check representing transparency, which is defined in [Preferences Display](#) is used.

Select Custom Color... Opens the Color Selector window to let you choose a color to use.

As in Preferences The color selected in the [Image Window Appearance](#) is used.

16.5.22 Show Menubar

The Show Menubar command enables and disables displaying the menubar. It may be useful to disable it if you are working in [full-screen mode](#). If the menubar is not displayed, you can right-click on the image to access the menubar entries.

You can set the default for the menubar in the [Image Window Appearance](#) dialog.

16.5.22.1 Activating the Command

- You can access this command from the image menubar through View → Show Menubar.

16.5.23 Show Rulers

The Show Rulers command enables and disables displaying the rulers. It may be useful to disable them if you are working in **full-screen mode**.

You can set the default for the rulers in the **Image Window Appearance** dialog.

16.5.23.1 Activating the Command

- You can access this command from the image menubar through View → Show Rulers,
- or by using the keyboard shortcut Shift-Ctrl-R.

16.5.24 Show Scrollbars

The Show Scrollbars command enables and disables displaying the scrollbars. It may be useful to disable them if you are working in **full-screen mode**.

You can set the default for the scrollbars in the **Image Window Appearance** dialog.

16.5.24.1 Activating the Command

- You can access this command from the image menubar through View → Show Scrollbars.

16.5.25 Show Statusbar

The Show Statusbar command enables and disables displaying the status bar. It may be useful to disable it when you are working in **full-screen mode**.

You can set the default for the status bar in the **Image Window Appearance** dialog.

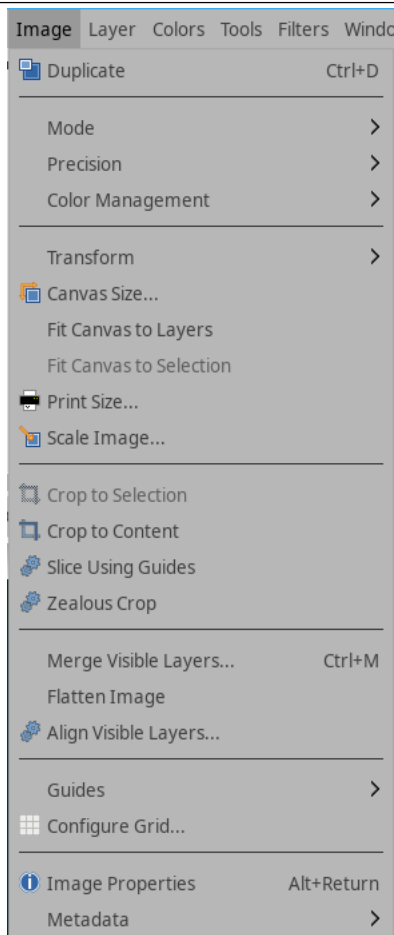
16.5.25.1 Activating the Command

- You can access this command from the image menubar through View → Show Statusbar.

16.6 The “Image” Menu

16.6.1 Overview

Figure 16.62 The Contents of the “Image” Menu



The Image menu contains commands which use or affect the entire image in some way, not just the active layer or some other specific part of the image.

Note



Besides the commands described here, you may also find other entries in the menu. They are not part of GIMP itself, but have been added by extensions (plug-ins). You can find information about the functionality of a Plugin by referring to its documentation.

16.6.2 Duplicate

The Duplicate command creates a new image which is an exact copy of the current one, with all of its layers, channels and paths. The GIMP Clipboard and the History are not affected.

Note

Don't mistake a duplicated image for a new view of this image. In a View → New View, all changes are passed on the original image.

16.6.2.1 Activating the Command

- You can access this command from the image menubar through Image → Duplicate,
- or by using the keyboard shortcut Ctrl-D.

16.6.3 Mode

Figure 16.63 The "Mode" submenu of the "Image" menu



The Mode submenu contains commands which let you change the color mode of the image. There are three modes.

16.6.3.1 Activating the Submenu

You can access this submenu from the image menubar through Image → Mode.

16.6.3.2 The Contents of the "Mode" Submenu

- **RGB**
- **Grayscale**
- **Indexed**

16.6.4 RGB mode

The RGB command converts your image to RGB mode. See the **RGB** description in the Glossary for more information. Normally, you work in this mode, which is well-adapted to the screen. It is possible to convert an RGB image to Grayscale or Indexed mode, but be careful: once you have saved the image, you can no longer retrieve the RGB colors, so you should work on a copy of your image.

16.6.4.1 Activating the command

- You can access this command from the image menu bar through Image → Mode → RGB.

16.6.5 Grayscale mode

You can use the Grayscale command to convert your image to grayscale. The resulting grayscale image will have a single channel composed of various shades of gray ranging from black to white.

The number of available tonal steps between black and white depends on the image precision:

At integer precision:

- An 8-bit integer grayscale image provides 255 available tonal steps from 0 (black) to 255 (white).

- A 16-bit integer grayscale image provides 65535 available tonal steps from 0 (black) to 65535 (white).
- A 32-bit integer grayscale image theoretically will provide 4294967295 tonal steps from 0 (black) to 4294967295 (white). But as high bit depth GIMP 2.10 does all internal processing at 32-bit floating point precision, the actual number of steps will be no more than the number of tonal steps available in a 32-bit floating point image.

At floating point precision: the available number of tonal steps in a grayscale image depends on the specified bit depth (8-bit, 16-bit, or 32-bit) and the type of floating point that is requested by the program (see [Floating-point arithmetic](#) for details).

16.6.5.1 Activating the Command

You can access this command from the image menubar through Image → Mode → Grayscale.

16.6.6 Indexed mode

The Indexed command converts your image to indexed mode. See [indexed colors](#) in the Glossary for more information about Indexed Color Mode.

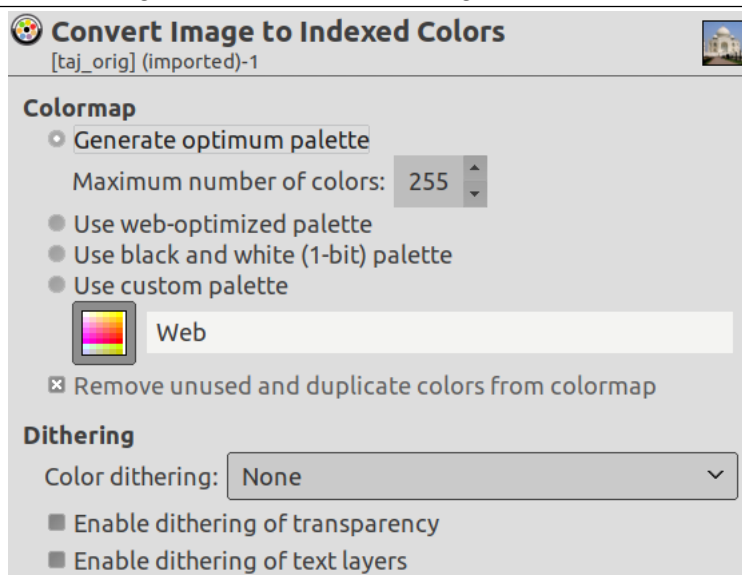
16.6.6.1 Activating the Command

- You can access this command from the image menubar through Image → Mode → Indexed.

16.6.6.2 The “Convert Image to Indexed Colors” dialog

The Indexed command opens the Convert Image to Indexed Colors dialog.

Figure 16.64 The “Convert Image to Indexed Colors” dialog



Colormap Options

- **Generate optimum palette:** This option generates the best possible palette with a default maximum number of 256 colors (classic GIF format). You can reduce this *Maximum Number of Colors*, although this may create unwanted effects (color banding) on smooth transitions. You may be able to lessen the unwanted effects by using dithering, however.
- **Use web-optimized palette:** use a palette that is optimized for the web.
- **Use black and white (1-bit) palette:** This option generates an image which uses only two colors, black and white.

- Use custom palette: This button lets you select a custom palette from a list. The number of colors is indicated for each palette. The "Web" palette, with 216 colors, is the "web-safe" palette. It was originally created by Netscape to provide colors that would look the same on both Macs and PCs, and Internet Explorer 3 could manage it. Since version 4, MSIE handles a 212 color palette. The problem of color similarity between all platforms has not been solved yet and it probably never will be. When designing a web page, you should keep two principles in mind: use light text on a dark background or dark text on a light background, and never rely on color to convey information.

Some colors in the palette may not be used if your image does not have many colors. They will be removed from the palette if the Remove unused colors from final palette option is checked.

Dithering Options Since an indexed image contains 256 colors or less, some colors in the original image may not be available in the palette. This may result in some blotchy or solid patches in areas which should have subtle color changes. The dithering options let you correct the unwanted effects created by the Palette Options.

A dithering filter tries to approximate a color which is missing from the palette by instead using clusters of pixels of similar colors which are in the palette. When seen from a distance, these pixels give the impression of a new color. See the Glossary for more information on **dithering**.

Three filters (plus "None") are available. It is not possible to predict what the result of a particular filter will be on your image, so you will have to try all of them and see which works best. The "Positioned Color Dithering" filter is well adapted to animations.

Figure 16.65 Example: full color, with no dithering



This is an example image with a smooth transition in RGB Mode.

Figure 16.66 Example: four colors, with no dithering



The same image, after being transformed to four indexed colors, without dithering.

Figure 16.67 Example: Floyd-Steinberg (normal)



The same image, with four indexed colors and "Floyd-Steinberg (normal)" dithering.

Figure 16.68 Example: Floyd-Steinberg (reduced color bleeding)



The same image, with four indexed colors and "Floyd-Steinberg (reduced color bleeding)" dithering.

In a GIF image, transparency is encoded in 1 bit: transparent or not transparent. To give the illusion of partial transparency, you can use the Enable dithering of transparency option. However, the **Semi-flatten** plug-in may give you better results.

Enable dithering of text layers: dithering text layers will make them uneditable.

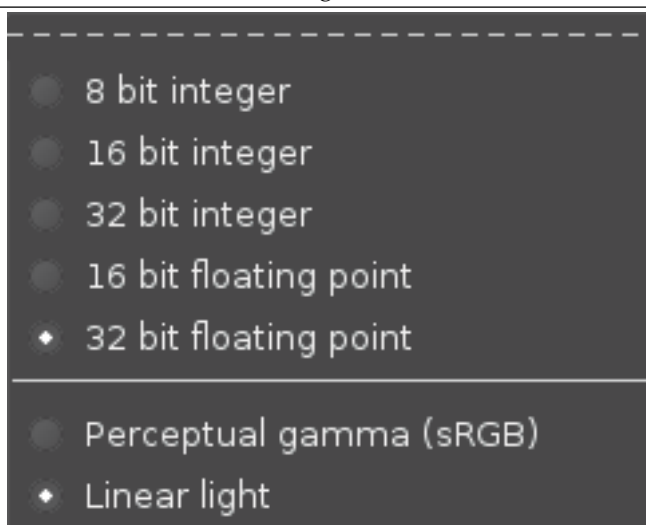
Note

You can edit the color palette of an indexed image by using the **Colormap Dialog**.

16.6.7 Precision

The Precision submenu contains commands which let you change the precision of the image. The Precision options affect the precision and channel encoding used for storing the image in RAM during processing.

Figure 16.69 The “Precision” submenu of the “Image” menu

**16.6.7.1 Activating the Submenu**

You can access this submenu from the image menubar through Image → Precision.

16.6.7.2 The Contents of the “Precision” Submenu

The Precision Menu is divided into two parts: precision and channel encoding.

Precision options The precision at which image data is stored is a function of the bit depth (8-bit vs 16-bit vs 32-bit) and whether the data is stored as integer data or floating point data. The Precision menu offers the following precision options:

1. Integer Precision Options
 - 8-bit integer
 - 16-bit integer
 - 32-bit integer
2. Floating point precision options
 - 16-bit floating point
 - 32-bit floating point

Channel Encoding Options The Precision menu also allows you to choose a **channel encoding** for the image data. Currently there are two choices:

- Perceptual gamma (sRGB)
- Linear light, which encodes the channel data using the linear gamma TRC.

16.6.7.3 Choosing the image precision and channel encoding

Note



Regardless of which options you choose in the Precision menu, in high bit depth GIMP 2.10 all internal processing is done at 32-bit floating point precision, and most editing operations are done using Linear light channel encoding.

Which Precision options should you choose? In a nutshell:

1. To take full advantage of GIMP's internal 32-bit floating point processing, choose 32-bit floating point precision and also choose the Linear light channel encoding.
2. If you are editing on a machine with limited RAM, or if you are editing very large images and layer stacks, consider using 16-bit floating point or integer precision.
3. If you want to take advantage of high bit depth image editing but you don't want to deal with floating point channel values, then use 16-bit integer precision.
4. When soft proofing an image, switch to Perceptual gamma (sRGB) channel encoding to avoid certain problems with soft proofing a linear gamma image using Little CMS.
5. On a very low-spec machine with not very much RAM, consider using 8-bit integer precision, in which case also choose the Perceptual gamma (sRGB) channel encoding (at 8-bit precision, if you choose the Linear light channel encoding your image will have horribly posterized shadows).

16.6.7.4 More information about the Precision options

1. Choosing the bit depth (8-bits vs 16-bits vs 32-bits):

- The bit depth of an image sets limits on how much precision is available when processing your image files. All things being equal, higher bit depths provide more precision.
- The bit depth of an image file partially determines how much RAM is required for processing. The higher the bit depth, the more RAM is required to store data during image processing. Other relevant factors include the size of the image layers and the number of layers in the layer stack.

2. Choosing between integer and floating point precision:

- Floating point precision is required for taking full advantage of high bit depth GIMP's internal 32-bit floating point processing. Floating point precision allows for the generation and use of channel values that fall outside the **display-referred range** from 0.0 ("display black") to 1.0 ("display white"), thus making possible very useful editing possibilities such as unbounded ICC profile conversions and **High Dynamic Range scene-referred** editing operations.
- Unlike floating point precision, integer precision cannot store channel values outside the display range. So choosing an integer precision from the Precision menu means that all floating point channel values produced during processing are clipped to fit within the equivalent floating point range between 0.0 and 1.0 inclusively:
 - 8-bit integer values are clipped to the range 0-255.
 - 16-bit integer values are clipped to the range 0-65535.
 - 32-bit integer values are clipped to the range 0-4294967295.
- At any given bit depth, all things being equal integer precision is more precise than floating point precision. So 16-bit integer precision is more precise than 16-bit floating point precision, and 32-bit integer precision is more precise than 32-bit floating point precision. However, in GIMP you don't get more precision by choosing 32-bit integer over 32-bit floating point: GIMP still does all internal processing using 32-bit floating point precision even if you choose 32-bit integer precision in the Precision menu. Remember, the Precision menu choices only determine how the image information is held in RAM.

- At any given bit depth, integer and floating point precision use approximately the same amount of RAM for internal calculations during image processing, and also require about the same amount of disk space when saving an image file to disk.

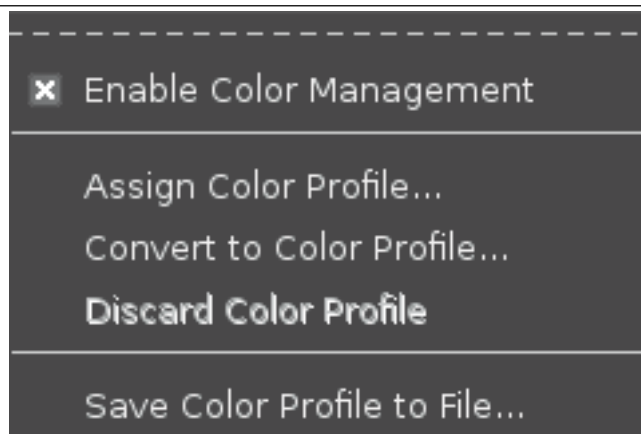
3. Choosing between Linear light and Perceptual gamma (sRGB) channel encoding:

- At 8-bit precision, if you choose the Linear light channel encoding your image will have horribly posterized shadows. So don't use Linear light unless you also choose a higher bit depth.
- When soft proofing, currently the gamut check will not return correct results if the image is at Linear light precision. So change to Perceptual gamma (sRGB) before activating soft proofing.
- Other than the fact that Linear light channel encoding is not suitable for 8-bit editing or for soft proofing, from a user perspective the channel encoding you choose in the Precision menu won't have much affect on your workflow:
 - Currently if you choose “Linear light”, then linear gamma channel values are displayed in the “pixel” values when using the the Color Picker Tool, Sample Points, and Pointer dialogs. If you choose “Perceptual gamma”, then perceptually uniform (sRGB) channel values are displayed instead.
 - Currently the channel encoding that you choose makes a difference in the wrong colors that you might see if you uncheck **Image/Color Management/Enable Color Management** and your image isn't already in one of the GIMP built-in sRGB color spaces (but with either channel encoding choice, the colors are still wrong).
 - The only other way (that I know of) in which the channel encoding chosen in the Precision menu might affect your workflow has to do with results of using the “Gamma hack” found in the Advanced Color Options.

16.6.8 Color Management

The Color Management submenu contains commands which let you change the ICC color profile associated with an image and also let you save the associated ICC color profile to disk. There are five options in the Color Management submenu.

Figure 16.70 The “Color Management” submenu of the “Image” menu



16.6.8.1 Activating the Color Management Submenu

You can access this command from the image menu bar through Image → Color Management.

16.6.8.2 The Contents of the “Color Management” Submenu

- **Enable Color Management**
- **Assign Color Profile**
- **Convert to Color Profile**

- **Discard Color Profile**
- **Save Color Profile to File**

16.6.9 Enable Color Management

If unchecked, Enable Color Management assigns a GIMP built-in sRGB color space to your image.

Also, if you've selected to display the image's assigned ICC color profile on the title or status bar, unchecking Enable Color Management prints the phrase "not color managed" to the title or status bar in place of the previously assigned color profile.

Note



Enable Color Management is checked by default. It's best to leave this option checked.

16.6.9.1 Activating the command

You can access this command from the image menu bar through Image → Color Management → Enable Color Management.

16.6.9.2 Use Notes regarding unchecking Enable Color Management

The best possible advice is to **never uncheck Enable Color Management**.

16.6.9.3 What does GIMP do when Enable Color Management is unchecked?

When you uncheck the option to Enable Color Management, GIMP does two things:

1. Whatever ICC profile is currently assigned to the image file is at least temporarily stored (pending subsequent editing, Precision, and Color Management actions), but isn't used. And then a built-in GIMP profile is assigned in place of the previously assigned ICC profile:
 - If the image is at Perceptual gamma (sRGB) precision, the ICC profile "GIMP built-in sRGB" is assigned.
 - If the image is at Linear light precision, the ICC profile "GIMP built-in Linear sRGB" is assigned.

You can confirm that one of GIMP's built-in sRGB color spaces has been assigned by checking "Image/Image Properties/Color Profile".

2. If you have set up the title or status bar to show the image's color space, then the title or status bar will display a message that the image is "not color managed". *In reality the image is still color managed*, but now the image is color managed "as if" it were in one of GIMP's built-in sRGB color spaces instead of whatever color space it's actually in.

16.6.9.4 When Enable Color Management is unchecked, what happens to the image and the image appearance?

Note



Assigning a new profile to an image doesn't change the image's actual channel values. Assigning a new ICC profile only changes the meaning of the channel values, which means the image appearance will change (unless the original and new profile are functionally equivalent).

When Enable Color Management is unchecked, GIMP assigns one of GIMP's built-in sRGB profiles to the image. Assigning a new ICC profile to an image doesn't change the image's channel values, but it does more or less drastically change the image's appearance:

1. If the image was already in one of GIMP's built-in color spaces (or if the assigned ICC profile is a profile that is functionally equivalent to the assigned GIMP built-in sRGB profile) then the image's appearance will not change.

2. If the image was not already in one of GIMP's built-in color spaces (and is not in a color space that is functionally equivalent to the assigned GIMP built-in sRGB profile), the image's appearance will change more or less drastically depending on three things:
 - What GIMP Precision channel encoding — Linear light or Perceptual gamma (sRGB) — the image was in before the Enable Color Management box was unchecked.

 - How far the image's originally assigned ICC profile's channel encoding ("TRC") is from the GIMP Precision channel encoding.

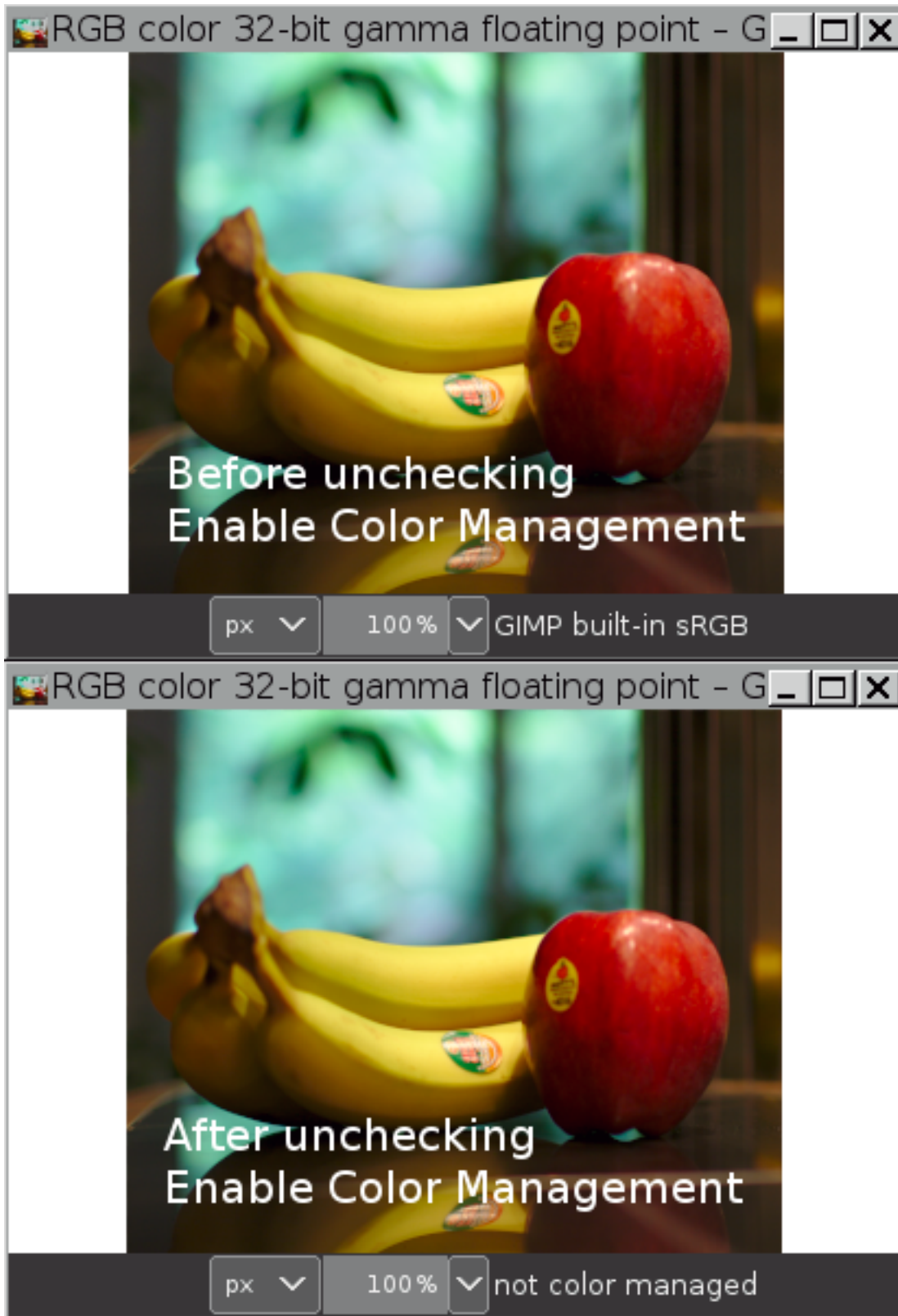
 - How far the image's originally assigned ICC profile's Red, Green, and Blue chromaticities are from GIMP's built-in sRGB chromaticities.

16.6.9.5 Two screenshots showing examples of correct and incorrect image appearances after unchecking Enable Color Management

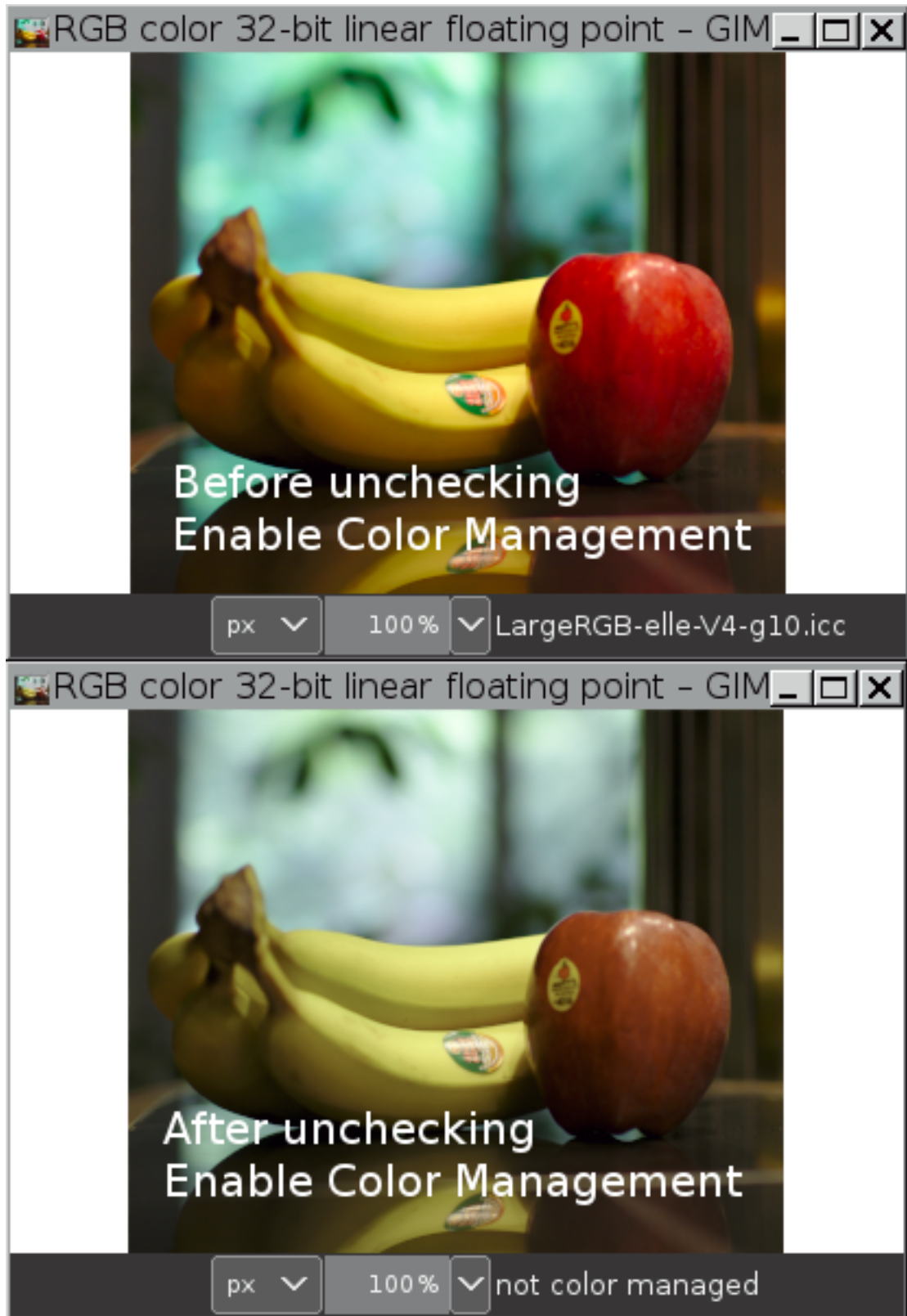
In both screenshots shown below, the image is color managed: An ICC profile is assigned to the image, and that profile is being used to send the image colors to the screen.

But in the second screenshot, after unchecking Enable Color Management, one of GIMP's built-in sRGB profiles has been incorrectly assigned to the image, so the colors look wrong.

In screenshot 1 below, the image is already in a GIMP built-in sRGB color space. So unchecking Enable Color Management makes no difference in the appearance of the image. In this particular case unchecking Enable Color Management actually makes no difference at all, except that if you've selected to show the image's assigned ICC profile in the title or status bar, then instead of showing the assigned ICC profile, the title or status bar will show the words "not color managed". But in reality the image is still color managed:



In screenshot 2 below, the channel encoding of the original profile matches the GIMP channel encoding (both are linear), but the LargeRGB-elle-V4-g10.icc profile chromaticities don't match the GIMP built-in sRGB chromaticities. So after unchecking Enable Color Management, the tonality is correct but the colors are wrong. The image is still color managed, but it's color managed using the wrong ICC profile:



Caution



If your image's originally assigned ICC profile doesn't have the same channel encoding and chromaticities as the GIMP built-in sRGB profile, and you uncheck and then immediately change your mind and recheck Enable Color Management, the originally assigned ICC profile will be reassigned to your image and your image channel values will be unchanged.

Otherwise, whether or not you can recover the originally assigned ICC profile and correct colors for your image depends on what else you've done between the unchecking and rechecking of Enable Color Management.

Again, the best possible advice is to **never uncheck Enable Color Management**.

16.6.10 Assign Color Profile

The Assign Color Profile allows you to assign a new ICC profile to an image.

16.6.10.1 Activating the command

You can access this command from the image menu bar through Image → Color Management → Assign Color Profile.

16.6.10.2 Use Notes for Assign Color Profile

When importing an image from disk, sometimes you might want to assign a new ICC profile to the image:

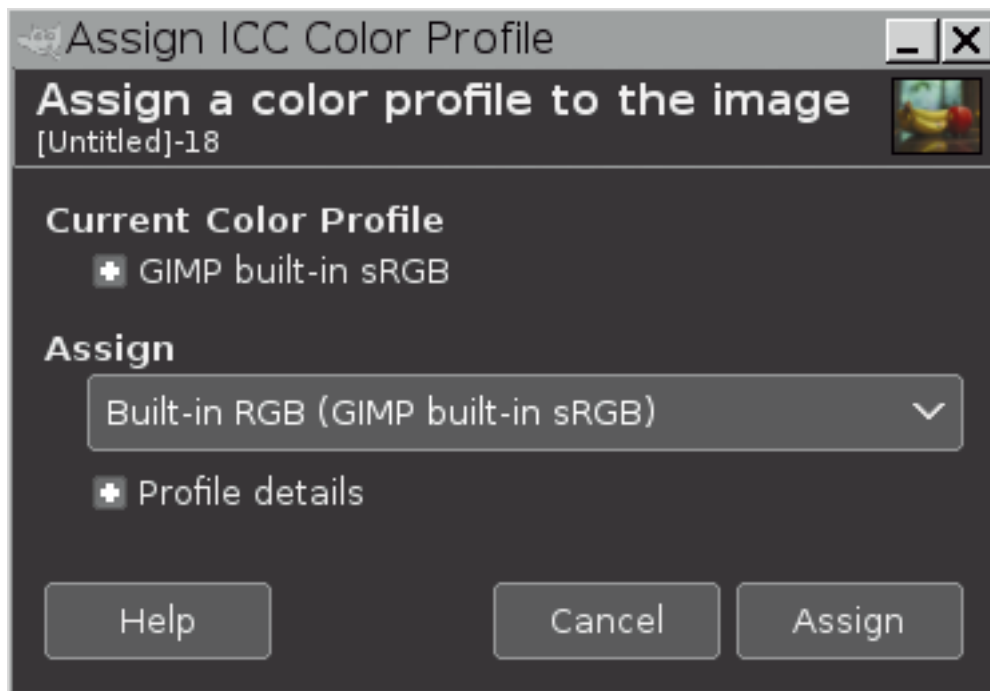
1. The image might not have an embedded ICC profile, in which case GIMP will automatically assign one of GIMP's built-in sRGB profiles:
 - If the image really is an sRGB image, then no further action is required.
 - If the image is not an sRGB image, then use Assign Color Profile to assign the correct ICC profile from disk.
2. The image might have an embedded ICC profile, but maybe it's not the right profile for the image, or maybe it's just not the profile you want assigned to the image. Use Assign Color Profile to assign another profile from disk.
3. The image might have an embedded sRGB profile, but you want to assign a GIMP built-in sRGB profile in place of the embedded sRGB profile. Or conversely, maybe the image is in GIMP's built-in sRGB color space, but you want to assign an sRGB profile from disk.

16.6.10.3 An example with screenshots showing how to use Assign Color Profile

Let's say you just imported an image file that you know should be in the AdobeRGB1998 color space. But for any number of possible reasons the image doesn't have an embedded ICC profile.

In cases where the image doesn't have an embedded ICC profile, GIMP will automatically assign a built-in sRGB profile. So your AdobeRGB1998 image won't show correct colors until you assign an AdobeRGB1998-compatible ICC profile from disk. The screenshots below show the procedure:

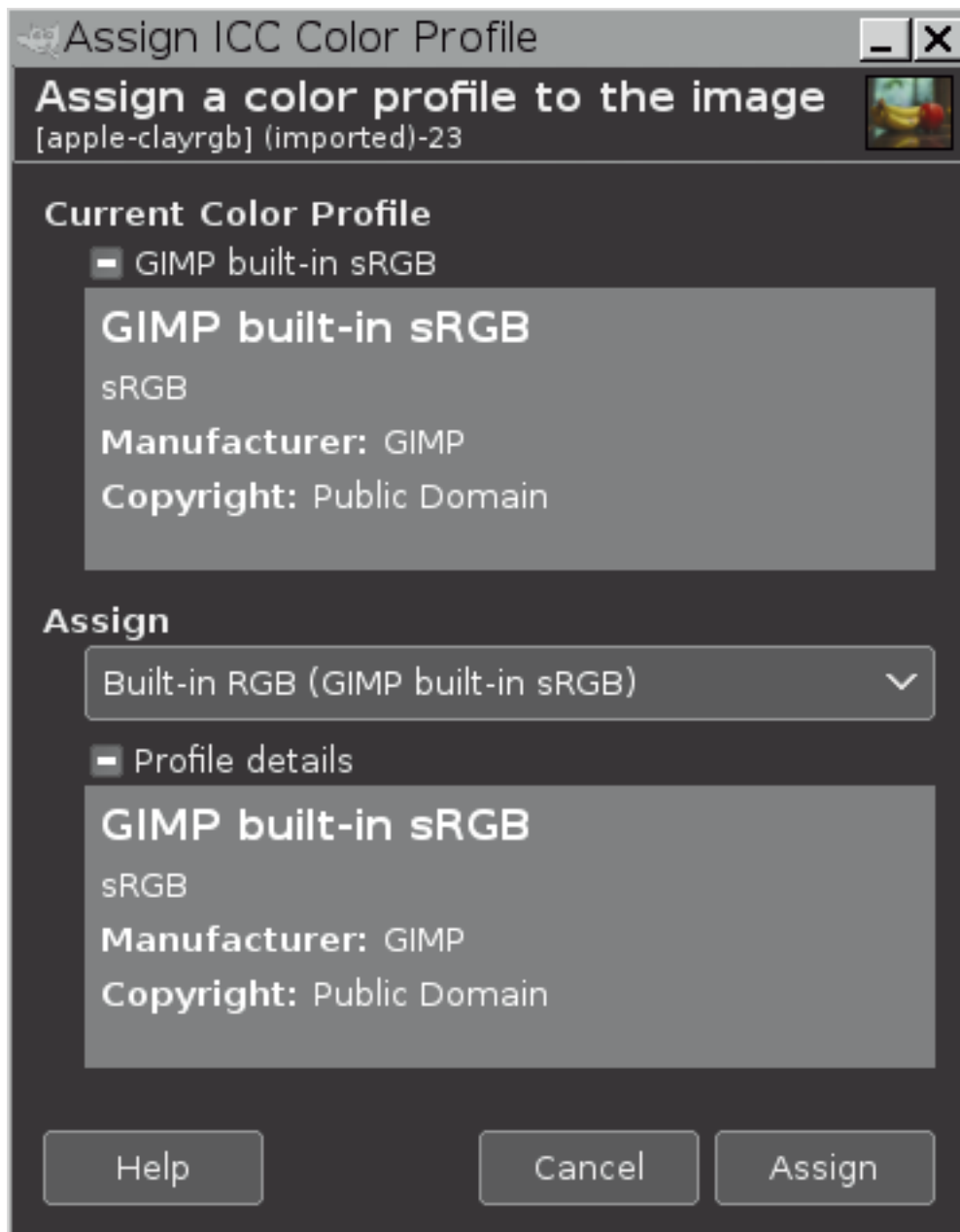
1. Accessing "Image/Color Management/Assign Color Profile" brings up the Assign ICC Color Profile dialog shown below:



2. Under Current Color Profile is a description of the currently assigned color profile, in this case GIMP's built-in sRGB profile. Clicking on the "+" icon next to the description of the currently assigned profile displays the contents of various information tags in the assigned ICC profile.

Clicking on the "+" icons next to the words Profile details displays the contents of various information tags in the ICC profile that you pick to be assigned to the image. Until you've actually picked a new profile, the profile in the Assign box defaults to a GIMP built-in sRGB profile.

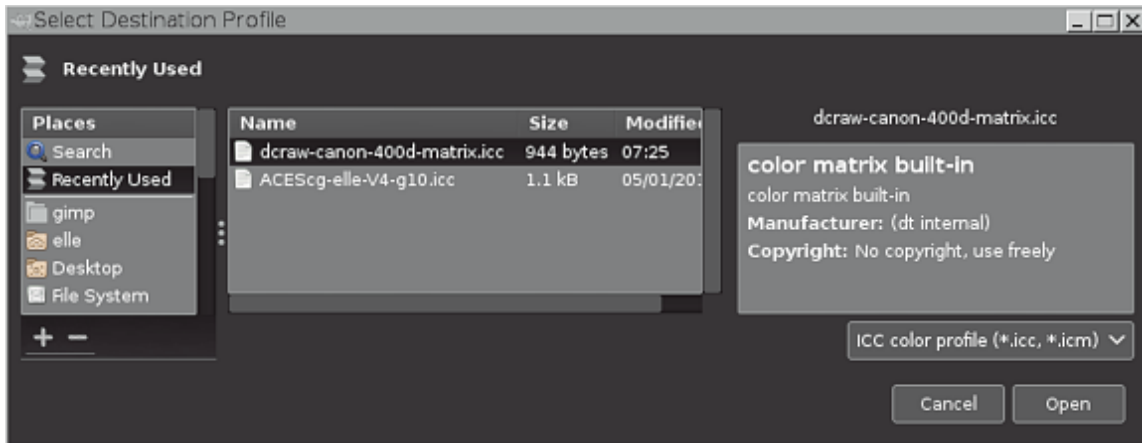
The screenshot below shows example profile descriptions revealed by clicking on the "+" icons:



3. Between Assign and Profile details is a drop-down box that allows you to pick a new profile. Clicking in the drop-down box brings up a list of recently used profiles (if any). At the bottom of the list is an option to Select color profile from disk...

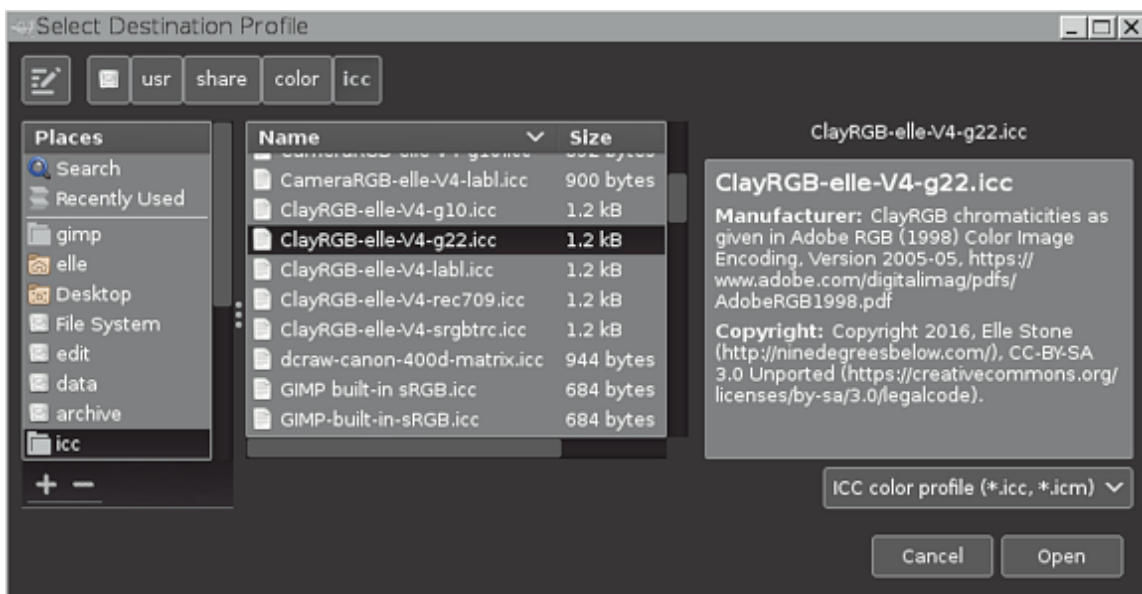


4. Clicking on Select color profile from disk... brings up the Select Destination Profile dialog for navigating to the disk location of the profile that you want to select from disk. The box has three panels:
 - (a) The panel on the left allows you to navigate your on-disk folder structure to the folder of your choice.
 - (b) The center panel initially shows another list of recently used profiles.
 - (c) If you click on one of the recently used profiles, the right panel will show informational tags that are embedded in the selected profile.



If the profile you want to select is shown in the list of recently used profiles, the profile can be directly selected from the list of recently used profiles by clicking on the Open button in the lower right corner. However, as the desired profile isn't in the list of recently used profile, the next step is to navigate to the profile's location on disk.

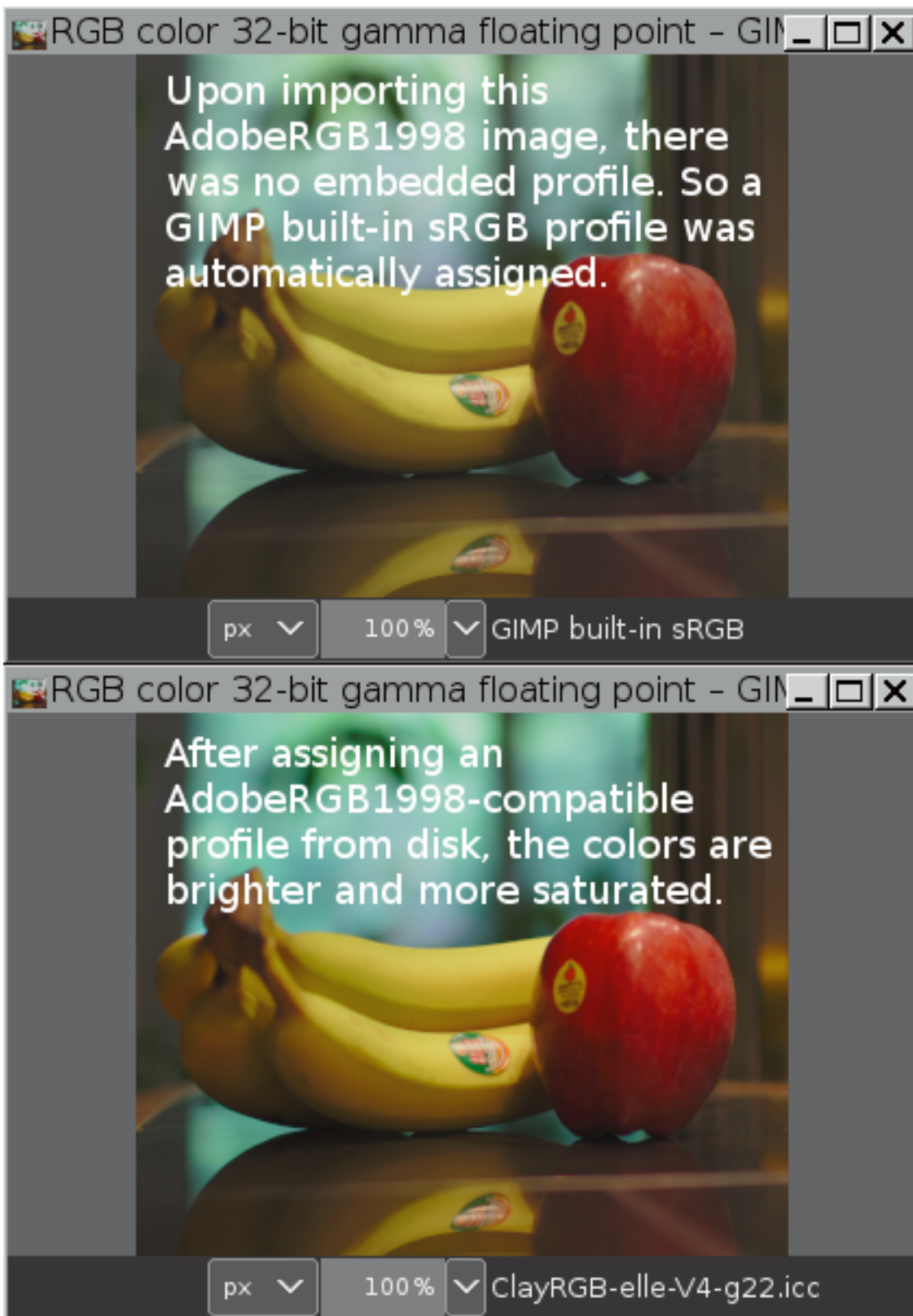
- As shown in the screenshot below, the left and center panels of the Select Destination Profile dialog allow you to navigate to where your ICC profiles are stored on disk, and then pick an appropriate ICC color profile (in this example, an AdobeRGB1998-compatible profile), and the right panel displays informational tags embedded in the selected profile. Click on the Open button to assign the selected profile to your image.



- Clicking on the Open button returns you to the Assign ICC Color Profile dialog, allowing you a chance to either assign the selected profile or else pick a new profile. Once you are sure you've picked the right profile, click on the Assign button (lower right corner), and the selected profile will be assigned to the image:



7. And now the image has been assigned an AdobeRGB1998-compatible ICC profile, and the colors are correctly displayed:



16.6.11 Convert to Color Profile

The Convert to Color Profile allows you to convert an image from its currently assigned ICC profile to another ICC profile.

16.6.11.1 Activating the command

You can access this command from the image menu bar through Image → Color Management → Convert to Color Profile.

16.6.11.2 Use Notes for Convert to Color Profile

In an ICC profile color managed editing application such as GIMP, every image has an assigned ICC color profile that (among other things) tells the Color Management System (in GIMP's case **Little CMS**) what color space to use when sending the image to the screen.

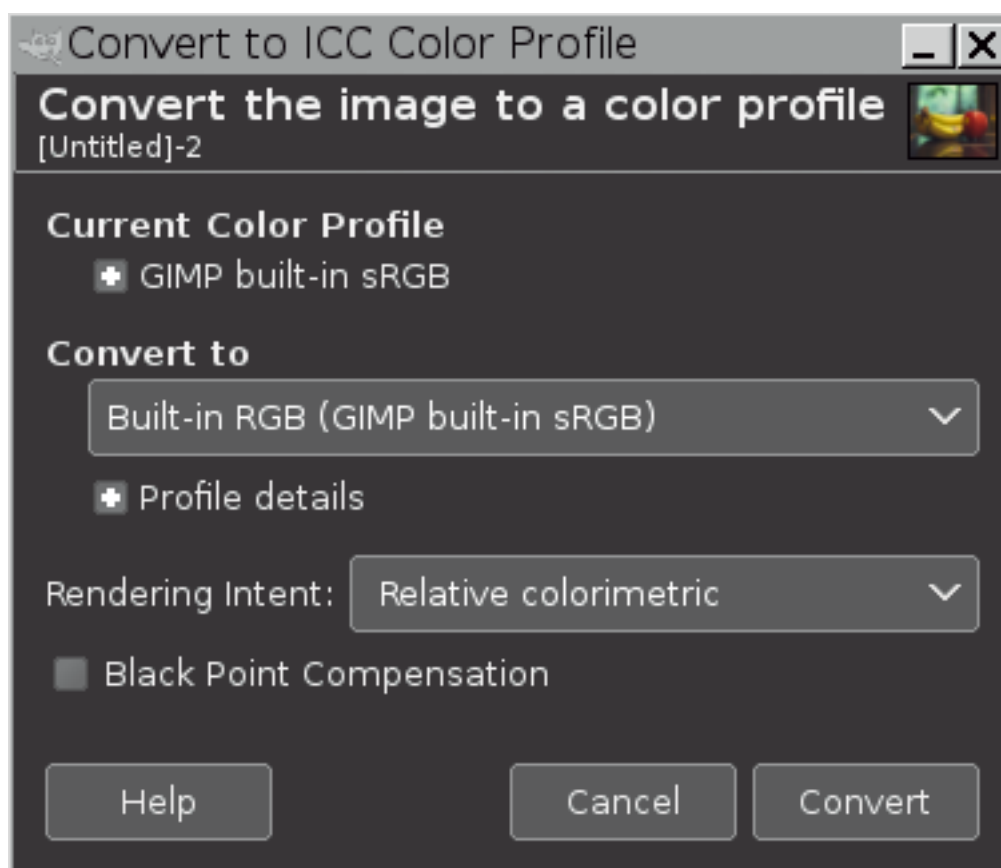
Sometimes it's convenient or necessary to convert an image from its currently assigned ICC color profile to another ICC color profile. For example:

1. Perhaps you want to convert the image from some other color space to GIMP's built-in sRGB color space.
2. Perhaps you want to convert the image to a printer profile before sending it out to a printing establishment.
3. Perhaps the currently assigned color space is not the right color space for the editing task at hand.

16.6.11.3 An example with screenshots showing how to use Convert to Color Profile

Let's say you have just finished editing an image. You edited the image in GIMP's built-in sRGB color space and now you want to convert a flattened copy of the image to a printer profile before sending it off to be printed. The screenshots below show the procedure:

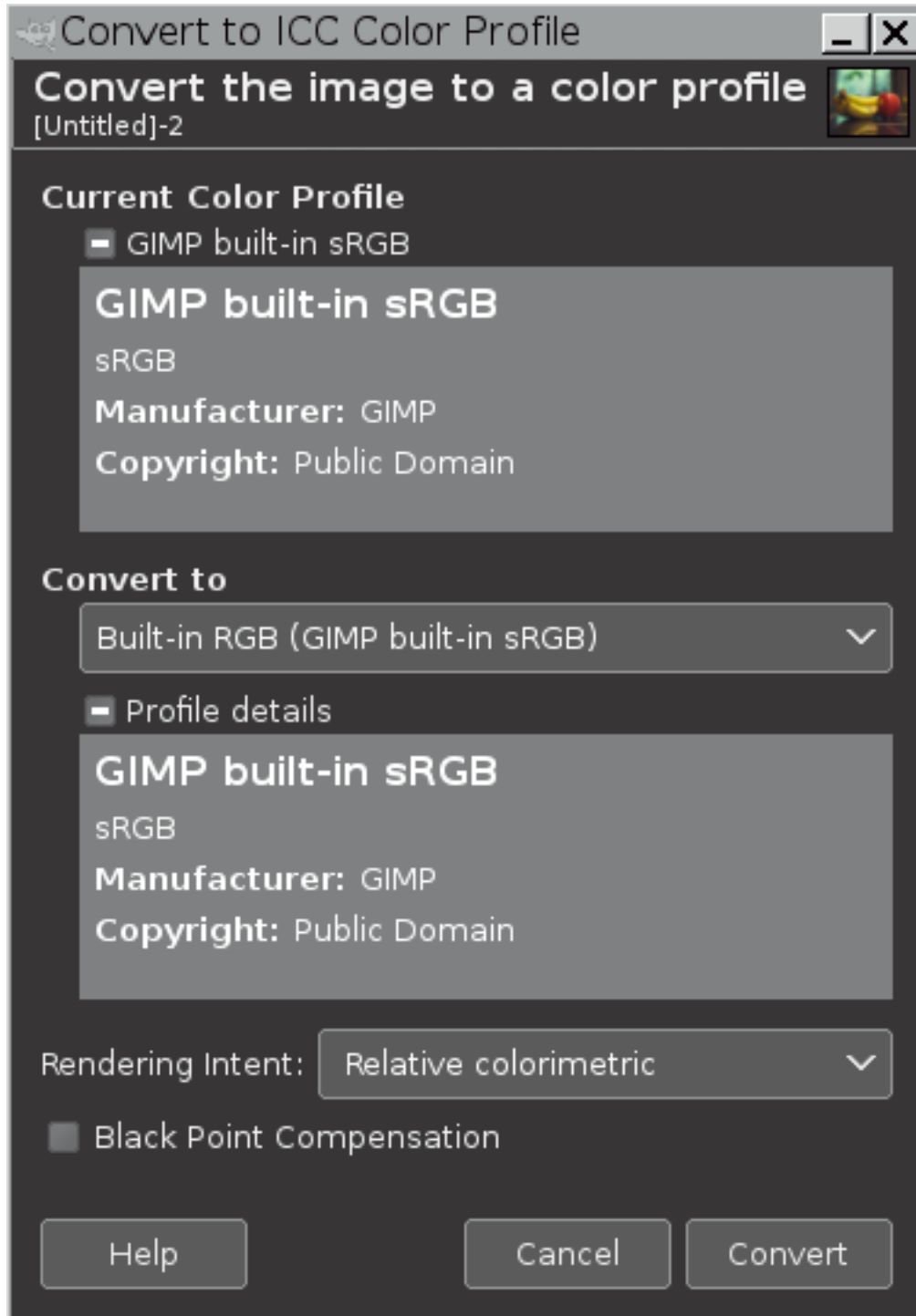
1. Select "Image/Color Management/Convert to Color Profile" to bring up the Convert to ICC Color Profile dialog:



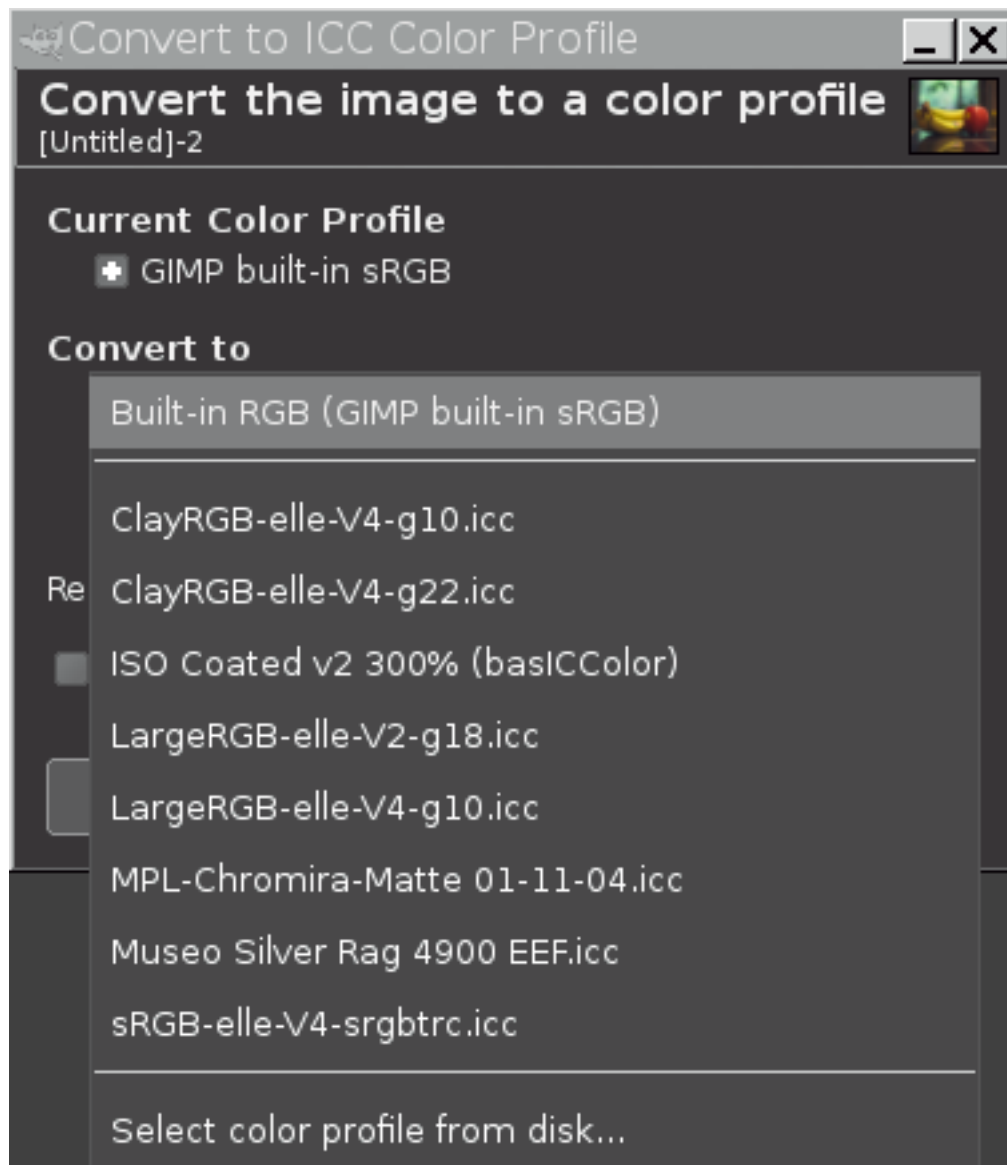
2. Under Current Color Profile is a description of the currently assigned color profile, in this case GIMP's built-in sRGB profile. Clicking on the "+" icon next to the description of the currently assigned profile displays the contents of various information tags in the assigned ICC profile.

Clicking on the "+" icons next to the words Profile details displays the contents of various information tags in the ICC profile that you pick as the profile to which the image will be converted. Until you've actually picked a new profile, the profile in the Convert to box defaults to a GIMP built-in sRGB profile.

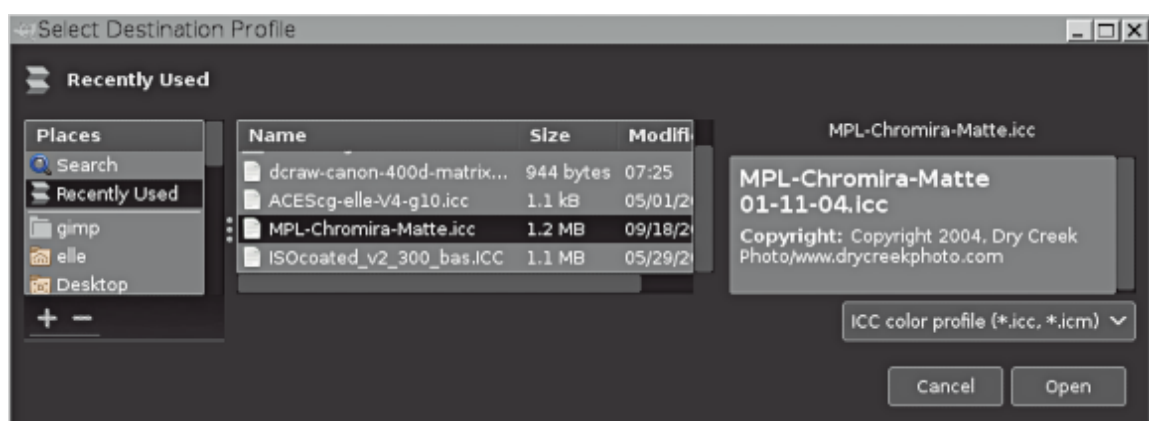
The screenshot below shows example profile descriptions revealed by clicking on the "+" icons:



3. Between Convert to and Profile details is a drop-down box that allows you to pick a new profile. Clicking in the drop-down box brings up a list of recently used profiles (if any). At the bottom of the list is an option to Select color profile from disk...:



4. Clicking on Select color profile from disk... brings up the Select Destination Profile dialog for navigating to the disk location of the profile that you want to select from disk. The box has three panels:
 - (a) The panel on the left allows you to navigate your on-disk folder structure to the folder of your choice.
 - (b) The center panel initially shows another list of recently used profiles.
 - (c) If you click on one of the recently used profiles, the right panel will show informational tags that are embedded in the selected profile.



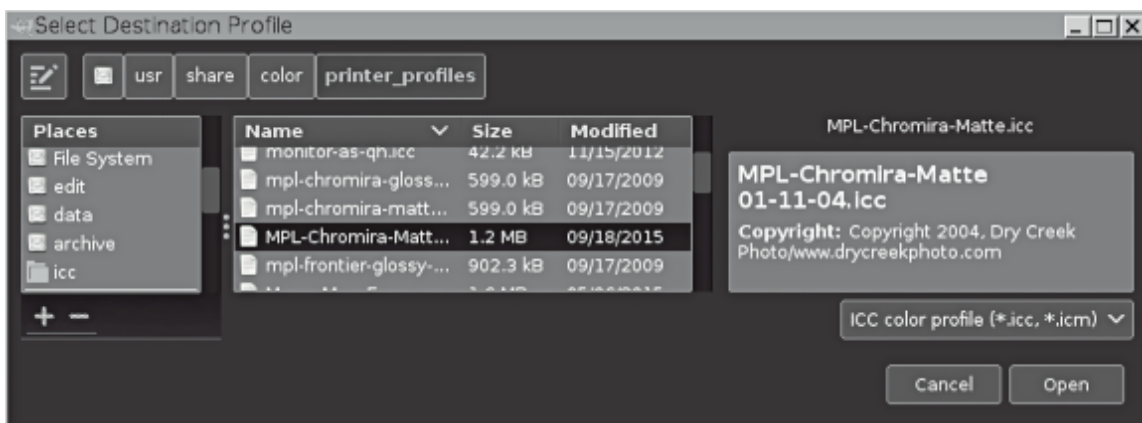
As the desired profile is shown in the list of recently used profiles, the profile can be directly selected from the list of recently used profiles by clicking on the Open button in the lower right corner. Or as shown in the next screenshot, it can be selected by navigating to the profile's location on disk.

Note

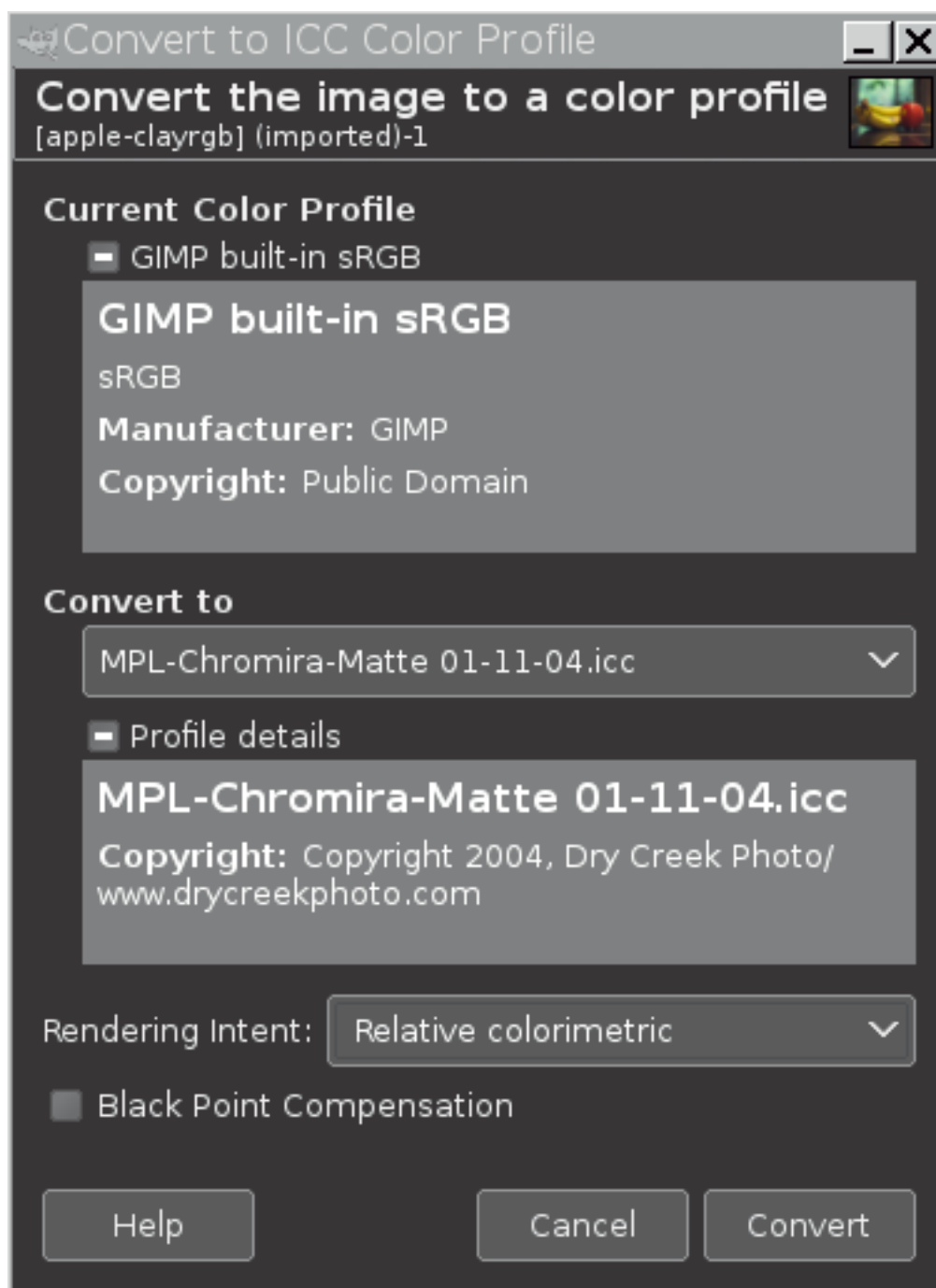


"Destination profile" is the technical term for the profile to which you want to convert your image. Similarly, "source profile" refers to the current ICC color space (the color space the image is already in, before you convert it to the destination profile).

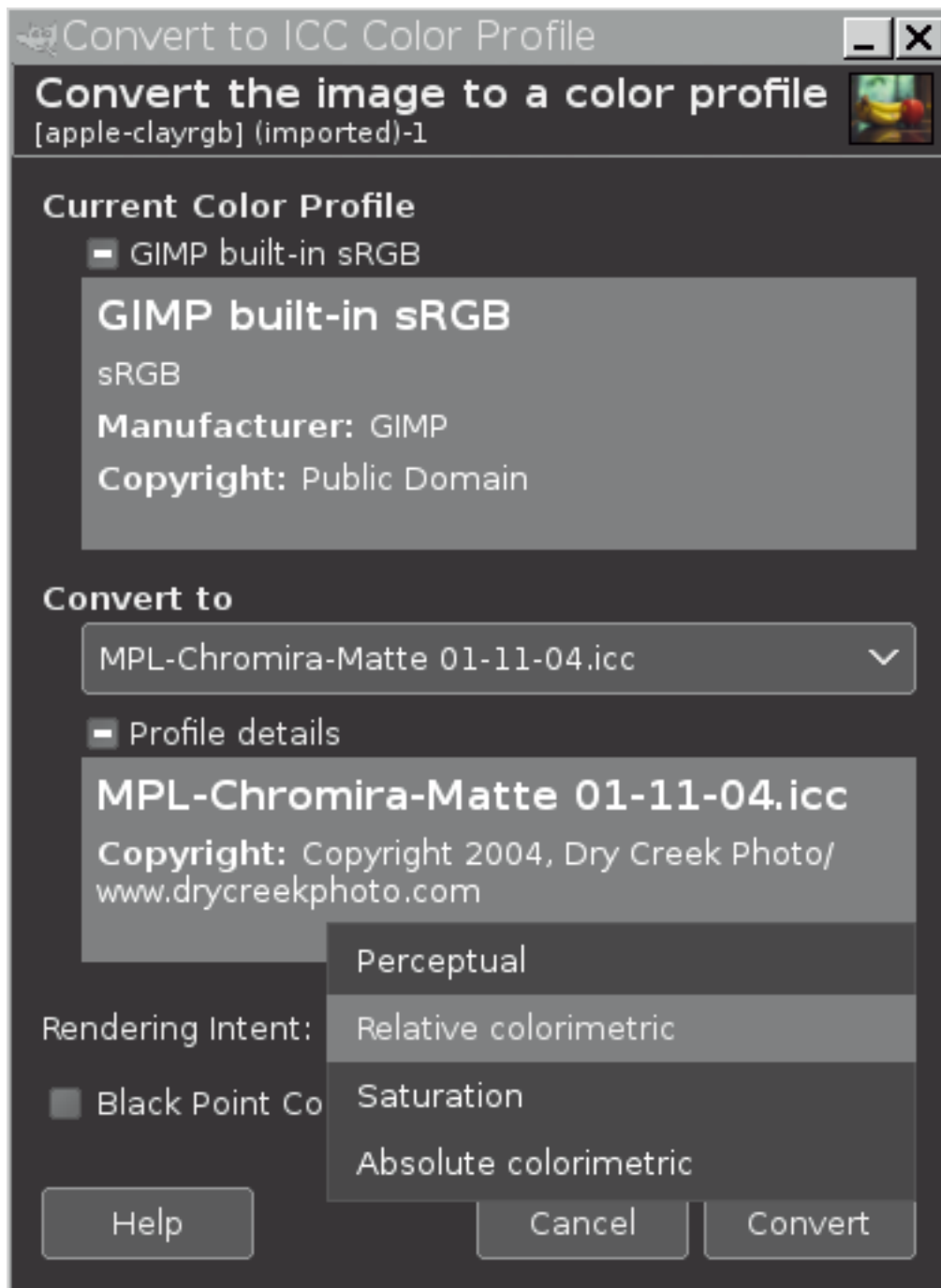
- As shown in the screenshot below, the left and center panels of the Select Destination Profile dialog allow you to navigate to where your ICC profiles are stored on disk, and then pick the desired destination ICC color profile, and the right panel displays informational tags embedded in the selected profile. Click on the Open button to select the "Destination Profile".



- Clicking on the Open button returns you to the Convert to ICC Color Profile dialog, allowing you a chance to either convert to the selected profile or else pick a new profile:



7. Once you are sure you've picked the right profile, the next step is to select the desired conversion options:



Selecting the desired conversion options requires two decisions:

- (a) Choose a rendering intent from the Rendering Intent drop-down box. The ICC profile rendering intents are:
 - Perceptual
 - Relative Colorimetric
 - Saturation
 - Absolute
 - (b) Decide whether to use black point compensation:
 - To use black point compensation, the Black Point Compensation box should be checked.
 - To not use black point compensation, the Black Point Compensation box should be unchecked.
8. When you've picked the desired conversion options, click on the Convert button in the lower right corner, and the image will be converted to the selected destination profile, in the current example, an RGB printer profile:



16.6.12 Discard Color Profile

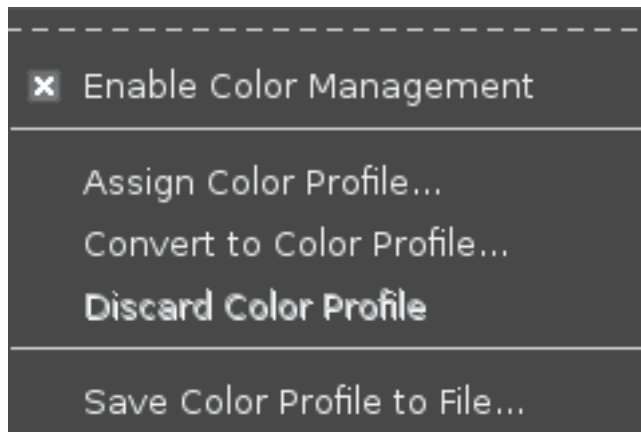
Discard Color Profile discards the image's currently assigned ICC profile, and instead assigns GIMP's built-in sRGB profile.

Note

Assigning a new profile to an image doesn't change the image's actual channel values. Assigning a new ICC profile only changes the meaning of the channel values, which means the image appearance will change (unless the original and new profile are functionally equivalent).

16.6.12.1 Activating the command

You can access this command from the image menu bar through Image → Color Management → Discard Color Profile.

**16.6.12.2 Use Notes for Discard Color Profile**

If you discard the image's color profile:

1. The image's *appearance* will change (unless the image is already in an ICC profile color space that has the same colorants and channel encoding as the newly-assigned GIMP sRGB color space).
2. The image's *channel values* are not changed by discarding the currently assigned profile and instead assigning GIMP's built-in sRGB profile.

Discarding the image's currently assigned profile is useful if you wish to export an image to disk without an embedded ICC profile.

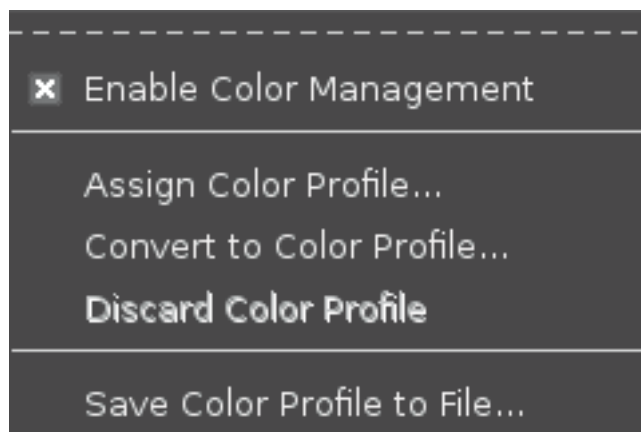
Discard Color Profile can only be used if the ICC color profile assigned to the image is not a GIMP built-in sRGB profile. GIMP's built-in sRGB profiles are not embedded in images that are exported to disk.

16.6.13 Save Color Profile to File

Save Color Profile to File allows you to save to disk a copy of the ICC profile that's assigned to your image.

16.6.13.1 Activating the command

You can access this command from the image menu bar through Image → Color Management → Save Color Profile to File.



16.6.13.2 Use Notes for Save Color Profile to File

Save Color Profile to File is useful whenever you want an on-disk copy of whatever ICC profile is assigned your image.

Save Color Profile to File can even be used to make an on-disk copy of GIMP’s built-in sRGB profile.

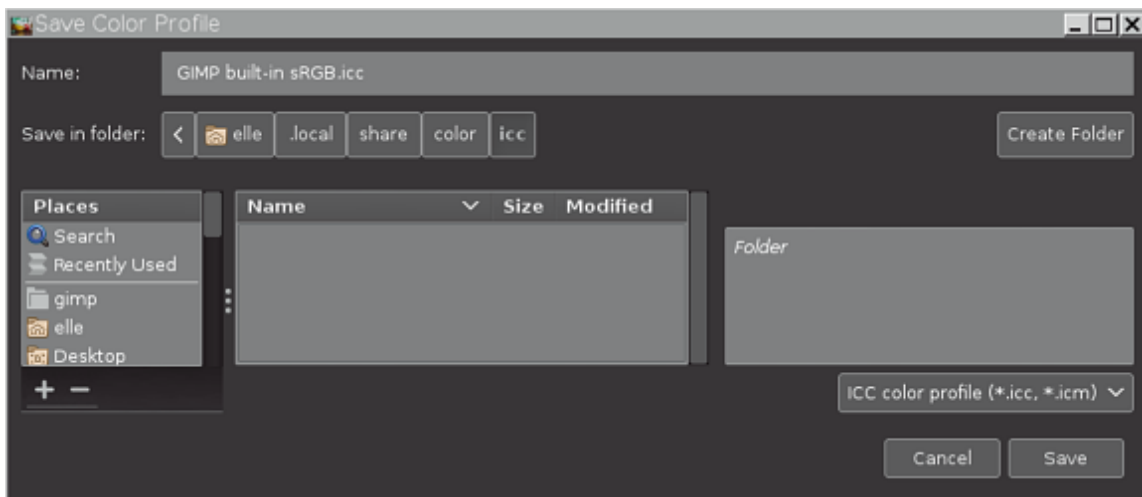
16.6.13.3 An example with screenshots showing how to use Save Color Profile to File

Let’s say you want to save a copy of the GIMP built-in sRGB profile to disk.

1. Open an image that has a GIMP built-in sRGB profile assigned:



2. Click on “Image/Color Management/Save Profile to File”:

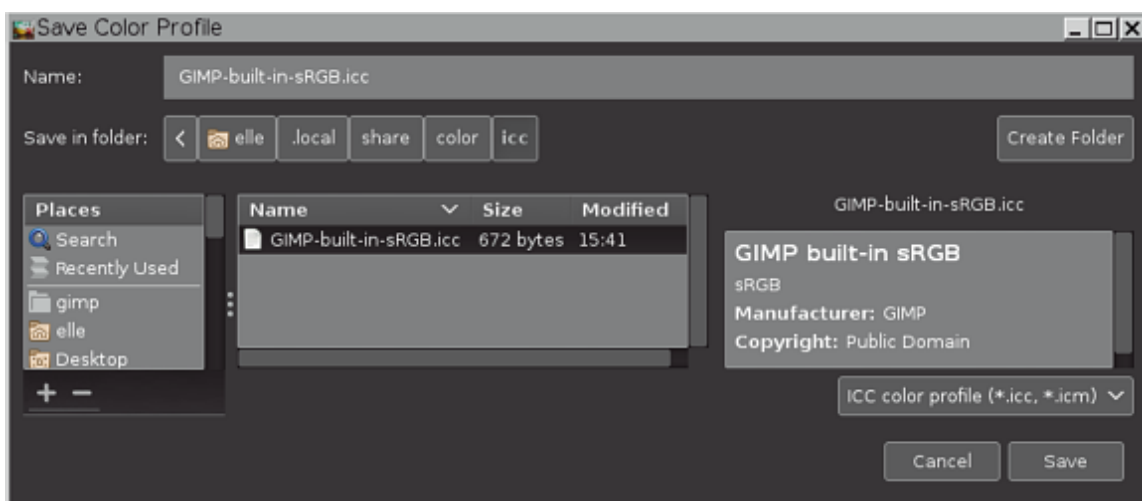


The “Save Color Profile” dialog is divided into three panels. Use the left and center panel to navigate to where you want to save the profile.

When you save a copy of the profile to disk, it’s perfectly OK to change the suggested file name (some programs, and especially command line utilities, don’t work as easily with file names that include spaces). If you change the file name, it’s a good idea to use either “.icc” or “.icm” as the file extension (some programs won’t recognize an ICC profile that uses some other file extension).

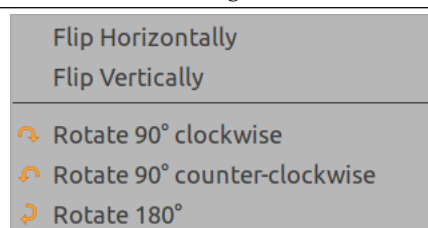
When you’ve chosen a location and typed in a file name, click on the “Save” button in the lower right corner to save a copy of the profile to disk.

3. You can even save over the top of an existing ICC profile, in which case the box on the right side of the dialog will display some informational tags, which hopefully will help you decide whether you really want to write over the top of the existing ICC profile:



16.6.14 Transform

Figure 16.71 The “Transform” submenu of the “Image” menu



The items on the Transform submenu transform the image by flipping it, rotating it or cropping it.

16.6.14.1 Activating the Submenu

- You can access this submenu from the image menubar through Image → Transform.

16.6.14.2 The Contents of the “Transform” Submenu

The Transform submenu has the following commands:

- Flip Horizontally; Flip Vertically
- Rotate 90° clockwise / counter-clockwise; Rotate 180°

16.6.15 Flip Horizontally; Flip Vertically

You can flip the image, or turn it over like a card, by using the Flip Horizontally or Flip Vertically commands. These commands work on the whole image. To flip a selection, use the **Flip Tool**. To flip a layer, use the functions of the Layer → Transform menu or the **Flip Tool**.

16.6.15.1 Activate the Commands

- You can access the horizontal flip command from the image menubar through Image → Transform → Flip Horizontally.
- You can access the vertical flip command from the image menubar through Image → Transform → Flip Vertically.

16.6.16 Rotation

You can rotate the image 90° clockwise or counter-clockwise, or rotate it 180°, by using the rotation commands on the Transform submenu of the Image menu. These commands can be used to change between Portrait and Landscape orientation. They work on the whole image. If you want to rotate the image at a different angle, rotate a selection or rotate a layer, use the **Rotate Tool**. You can also rotate a layer by using the **Layer Transform** menu.

16.6.16.1 Activate the Commands

You can access these three commands from the image menubar through

- Image → Transform → Rotate 90 degrees CW,
- Image → Transform → Rotate 90 degrees CCW and
- Image → Transform → Rotate 180°.

16.6.17 Canvas Size

The “canvas” is the visible area of the image. By default the size of the canvas coincides with the size of the layers. The Canvas Size... command opens the “Set Image Canvas Size” dialog that lets you enlarge or reduce the canvas size. You can, if you want, modify the size of the layers. When you enlarge the canvas, you create free space around the contents of the image. When you reduce it, the visible area is cropped, however the layers still extend beyond the canvas border.

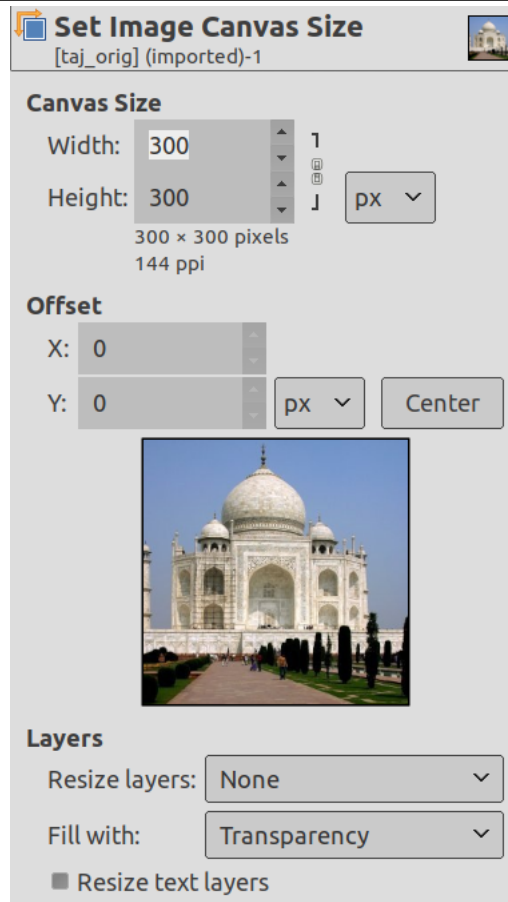
When you reduce the canvas size, the new canvas appears surrounded with a thin negative border in the preview. The mouse pointer is a moving cross: click and drag to move the image against this frame.

16.6.17.1 Activating the Command

- You can access this command from the image menubar through Image → Canvas Size....

16.6.17.2 Description of the "Set Image Canvas Size" dialog

Figure 16.72 The "Set Image Canvas Size" dialog



Canvas Size

Width; Height You can set the Width and the Height of the canvas. The default units are pixels but you can choose different units, e.g. percent, if you want to set the new dimensions relative to the current dimensions. If the Chain to the right of the Width and Height is not broken, both Width and Height keep the same relative size to each other. That is, if you change one of the values, the other one also changes a corresponding amount. If you break the Chain by clicking on it, you can set Width and Height separately.

Whatever units you use, information about the size in pixels and the current resolution are always displayed below the *Width* and *Height* fields. You cannot change the resolution in the Canvas Size dialog; if you want to do that, use the [Print Size dialog](#).

Offset

The Offset values are used to place the image (the image, not the active layer) on the canvas. You can see the size and the content of the canvas in the preview of the dialog window. When the canvas is smaller than the image, the preview window shows it in a frame with a thin negative border.

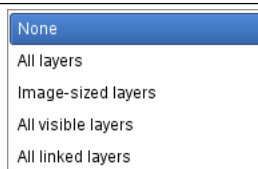
X ; Y The X and Y specify the coordinates of the upper left corner of the image relative to the upper left corner of the canvas. They are negative when the canvas is smaller than the image. You can place the image in different ways (of course, the coordinates can't exceed the canvas borders):



- by click-and-dragging the image,
- by entering values in the X and Y text boxes,
- by clicking on the small arrow-heads. This increments the value by one pixel (unit).
- And when the focus is on a text box, you can use the keyboard arrow keys, **Up** and **Down** to change by one pixel (unit), or **PageUp** and **PageDown** to change the value by 10 pixels (units).

Layers

- Resize layers: this drop-down list offers you several possibilities:

Figure 16.73 The Resize layers list



- None: default option. No layer is resized, only the canvas is.
 - All Layers: all layers are resized to canvas size.
 - Image-sized layers: only layers with the same size as the image are sized to canvas size.
 - All visible layers: only visible layers, marked with a  icon, in the Layer Dialog, are sized to canvas size.
 - All linked layers: only linked layers, marked with a  in the Layer Dialog, are sized to canvas size.
- Fill with: you can fill resized layers with Transparency (default), Background color, Foreground color, White, Pattern.
 - Resize text layers: Resizing text layers will make them uneditable.

Center The Center button allows you to center the image on the canvas. When you click on the Center button, the offset values are automatically calculated and displayed in the text boxes.

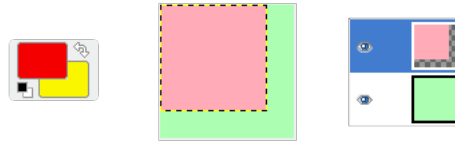
Note

When you click on the Resize button, the canvas is resized, but the pixel information and the drawing scale of the image are unchanged.

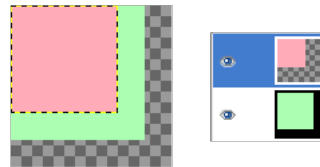


If the layers of the image did not extend beyond the borders of the canvas before you changed its size, there are no layers on the part of the canvas that was added by resizing it. Therefore, this part of the canvas is transparent and displayed with a checkered pattern, and it is not immediately available for painting. You can either **flatten** the image, in which case you will get an image with a single layer that fits the canvas exactly, or you can use the **Layer to Image Size** command to resize only the active layer, without changing any other layers. You can also create a new layer and fill it with the background you want. By doing this, you create a digital “passe-partout” (a kind of glass mount with a removable back for slipping in a photograph).

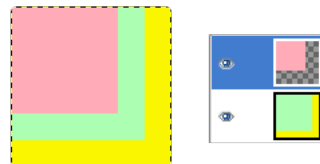
16.6.17.3 Example

Figure 16.74 Original image

We started with a green background layer 100x100 pixels, which defines a default canvas with the same size. Then we added a new red layer 80x80 pixels. The active layer limits are marked with a black and yellow dotted line. The red layer does not fill the canvas completely: the unoccupied part is transparent. The background color in the Toolbox is yellow.

Figure 16.75 Canvas enlarged (layers unchanged)

The canvas has been enlarged to 120x120 pixels. The layers size remained unchanged. The unoccupied part of the canvas is transparent.

Figure 16.76 Canvas enlarged (all layers changed)

The canvas has been enlarged to 120x120 pixels. All layers have been enlarged to the canvas size. The undrawn part is transparent in the red layer and yellow (background color in Toolbox) in the green background layer.

16.6.17.4 What's Canvas Size useful for?

You may want to add some stuff around your image: enlarge canvas size, add a new layer that will have the same size as the new canvas and then paint this new layer. That's the converse of cropping.

You can also use this command to crop an image:

Figure 16.77 Resizing canvas

Click on the chain next to Width and Height entries to unlink dimensions. By modifying these dimensions and moving image against canvas, by trial and error, you can crop the part of the image you want. Click on the Center button and then on the Resize button.

Figure 16.78 Cropped image

**Note**

The **Crop** tool is easier to use.

16.6.18 Fit Canvas to Layers

The Fit Canvas to Layers command adapts the canvas size to the size of the largest layer in the image, in both width and height.

When you create or open an image, the canvas size is defined as the image size and remains unchanged if you add new layers. If you add a layer larger than the canvas, only the area limited by the canvas will be visible. To show the whole layer, use this command.

16.6.18.1 Activate the command

- You can access this command from the image menubar through Image → Fit Canvas to Layers.

16.6.19 Fit Canvas to Selection

The Fit Canvas to Selection command adapts the canvas size to the size of the selection, in both width and height.

16.6.19.1 Activate the command

- You can access this command from the image menubar through Image → Fit Canvas to Selection.

16.6.20 Print Size

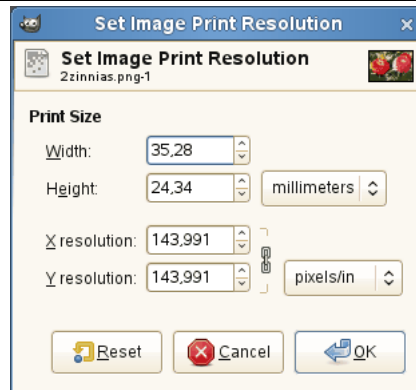
This command opens the “Set Image Print Resolution” dialog that allows you to change the *dimensions of a printed image* and its *resolution*. This command does not change the number of pixels in the image and it does not resample the image. (If you want to change the size of an image by resampling it, use the **Scale Image** command.)

16.6.20.1 Activating the Dialog

- You can access this dialog from the image menubar through Image → Print Size....

16.6.20.2 Options in the "Print Size" Dialog

Figure 16.79 The "Set Image Print Resolution" dialog



The output resolution determines the number of pixels used per unit length for the printed image. Do not confuse the output resolution with the printer's resolution, which is a printer feature and expressed in dpi (dots per inch); several dots are used to print a pixel.

When the dialog is displayed, the resolution shown in the boxes is the resolution of the original image. If you increase the output resolution, the printed page will be smaller, since more pixels are used per unit of length. Conversely, and for the same reason, resizing the image modifies the resolution.

Increasing the resolution results in increasing the sharpness of the printed page. This is quite different from simply reducing the image size by scaling it, since no pixels (and no image information) are removed.

Width; Height You can set the printing Width and Height by using the text boxes. You can also choose the units for these values from the dropdown list.

As soon as you change the Width or the Height, the X and/or Y resolution values automatically change accordingly. If the two resolution values remain linked, the relationship of the width to the height of the image is also automatically maintained. If you would like to set these values independently of each other, simply click on the chain symbol to break the link.

X resolution; Y resolution You can set the resolution used to calculate the printed width and height from the physical size of the image, that is, the number of pixels in it.

Use the text boxes to change these resolution values. They can be linked to keep their relationship constant. The closed chain symbol between the two boxes indicates that the values are linked together. If you break the link by clicking on the chain symbol, you will be able to set the values independently of each other.

16.6.21 Scale Image

The Scale Image command enlarges or reduces the physical size of the image by changing the number of pixels it contains. It changes the size of the contents of the image and resizes the canvas accordingly.

It operates on the entire image. If your image has layers of different sizes, making the image smaller could shrink some of them down to nothing, since a layer cannot be less than one pixel wide or high. If this happens, you will be warned before the operation is performed.

If you only want to scale a particular layer, use the **Scale Layer** command.

Note



If scaling would produce an image larger than the “Maximum new image size” set in the **System Resources** page of the Preferences dialog (which has a default of 128 Mb), you are warned and asked to confirm the operation before it is performed. You may not experience any problems if you confirm the operation, but you should be aware that very large images consume a lot of resources and extremely large images may take more resources than you have, causing GIMP to crash or not perform well.

16.6.21.1 Activate the Command

- You can access this command from the image menubar through Image → Scale Image....

16.6.21.2 The “Scale Image” Dialog

Figure 16.80 The “Scale Image” dialog

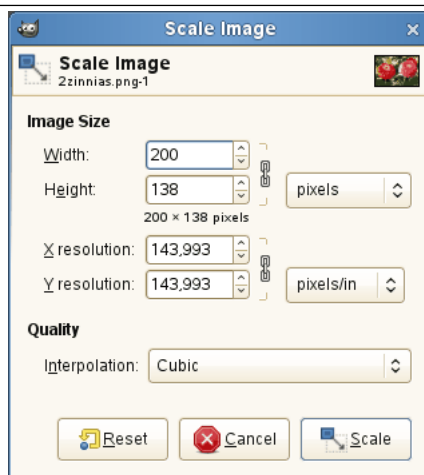


Image Size You should keep in mind that an image can be located in one of four places: in the image file, in RAM after it has been loaded, on your screen when it is displayed, or on paper after it has been printed. Scaling the image changes the number of pixels (the amount of information) the image contains, so it directly affects the amount of memory the image needs (in RAM or in a file).

However printing size also depends upon the resolution of the image, which essentially determines how many pixels there will be on each inch of paper. If you want to change the printing size without scaling the image and changing the number of pixels in it, you should use the **Print Size** dialog. The screen size depends not only on the number of pixels, but also on the screen resolution, the zoom factor and the setting of the **Dot for Dot** option.

If you enlarge an image beyond its original size, GIMP calculates the missing pixels by interpolation, but it does not add any new detail. The more you enlarge an image, the more blurred it becomes. The appearance of an enlarged image depends upon the interpolation method you choose. You may improve the appearance by using the **Sharpen (Unsharp Mask)** filter after you have scaled an image, but it is best to use high resolution when you scan, take digital photographs or produce digital images by other means. Raster images inherently do not scale up well.

You may need to reduce your image if you intend to use it on a web page. You have to consider that most internet users have relatively small screens which cannot completely display a large image. Many screens have a resolution of 1024x768 or even less.

Adding or removing pixels is called “Resampling”.

Width; Height When you click on the Scale command, the dialog displays the dimensions of the original image in pixels. You can set the Width and the Height you want to give to your image by adding or removing pixels. If the chain icon next to the Width and Height boxes is unbroken, the Width and Height will stay in the same proportion to each other. If you break the chain by clicking on it, you can set them independently, but this will distort the image.

However, you do not have to set the dimensions in pixels. You can choose different units from the drop-down menu. If you choose percent as the units, you can set the image size relative to its original size. You can also use physical units, such as inches or millimeters. If you do that, you should set the X resolution and Y resolution fields to appropriate values, because they are used to convert between physical units and image dimensions in pixels.

X resolution; Y resolution You can set the printing resolution for the image in the X resolution and Y resolution fields. You can also change the units of measurement by using the drop-down menu.

Quality To change the image size, either some pixels have to be removed or new pixels must be added. The process you use determines the quality of the result. The Interpolation drop down list provides a selection of available methods of interpolating the color of pixels in a scaled image:

Interpolation methods are described in [Interpolation](#).

Note



See also the [Scale tool](#), which lets you scale a layer, a selection or a path.

16.6.22 Crop Image

You can crop image in two ways:

- Crop to selection
- Crop to content

16.6.22.1 Crop to selection

The Crop to Selection command crops the image to the boundary of the selection by removing any strips at the edges whose contents are all completely unselected. Areas which are partially selected (for example, by feathering) are not cropped. If the selection has been feathered, cropping is performed on the external limit of the feathered area. If there is no selection for the image, the menu entry is disabled and grayed out.

Note



This command crops all of the image layers. To crop the active layer only, use the [Crop to selection](#) command.

You can access this command on the image menu bar through Image → Crop to Selection.

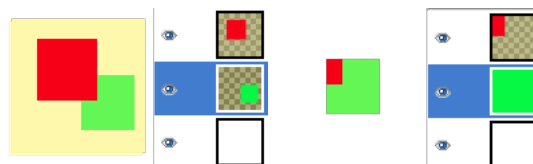
16.6.22.2 Crop to content

Before GIMP-2.10, this command was named "Autocrop image". The Crop to content command removes the borders from an image. It searches the active layer for the largest possible border area that is all the same color, and then crops this area from the image, as if you had used the [Crop](#) tool.

Caution

Note carefully that this command only uses the *active layer* of the image to find borders. Other layers are cropped according to the same limits as limits in the active layer.

Figure 16.81 "Crop to content" example



(a) This image is made of (b) "Crop to content" has three layers. One with a red cropped the green square and square, another with a green made a layer from it. The other square; both on a yellow semi- layers have been cropped to transparent background. The the same size as the green one. green layer is active. Only a small part of the red square has been kept.

You can access this command on the image menu bar through Image → Crop to Content.

16.6.23 Slice Using Guides

The Slice Using Guides command slices up the current image, based on the image's guides. It cuts the image along each guide, similar to slicing documents in an office with a guillotine (paper cutter) and creates new images out of the pieces. For further information on guides, see Section [12.2.2](#).

16.6.23.1 Activate the Command

- You can access this command from the image menubar through Image → Slice Using Guides.

16.6.24 Zealous Crop

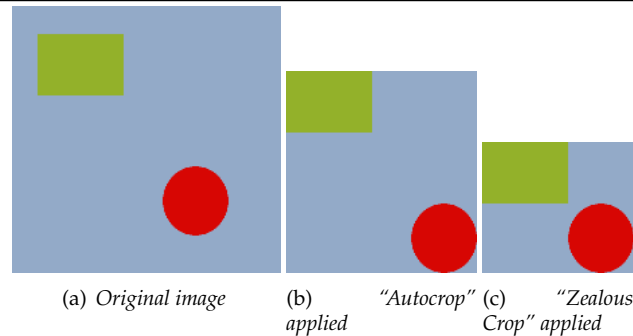
The Zealous Crop command crops an image using a single solid color as a guide. It crops the edges, as with the **Autocrop** command, but it also crops the areas in the middle of the image which have the same color (at least, in principle).

Caution

Please note that Zealous Crop crops all of the layers, although it only analyzes the active layer. This may lead to a loss of information from the other layers.

16.6.24.1 Example

Figure 16.82 "Zealous Crop" Example



16.6.24.2 Activate the Command

- You can access this command from the image menu bar through Image → Zealous Crop.

16.6.25 Merge Visible Layers

The Merge Visible Layers command merges the layers which are visible into a single layer. Visible layers are those which are indicated on the Layers dialog with an "eye" icon.

Note



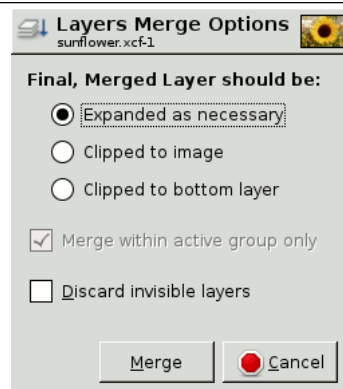
With this command, the original visible layers disappear. With the **New From Visible** command, a new layer is created at top of the stack and original visible layers persist.

16.6.25.1 Activate the Command

- You can access this command from the image menubar through Image → Merge Visible Layers...
- or by using the keyboard shortcut Ctrl-M.

16.6.25.2 Description of the "Layers Merge Options" Dialog

Figure 16.83 The "Layers Merge Options" Dialog



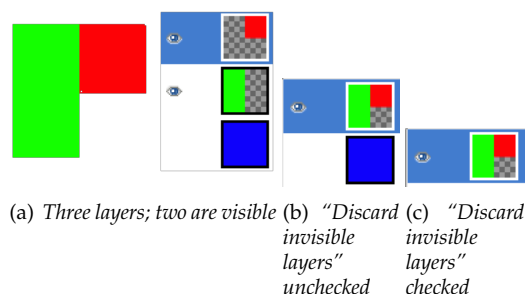
Final, Merged Layer should be: Visible layers are the layers which are marked with an "eye" icon in the Layers dialog.

- *Expanded as necessary:* The final layer is large enough to contain all of the merged layers. Please note that a layer in GIMP can be larger than the image.
- *Clipped to image:* The final layer is the same size as the image. Remember that layers in GIMP can be larger than the image itself. Any layers in the image that are larger than the image are clipped by this option.
- *Clipped to bottom layer:* The final layer is the same size as the bottom layer. If the bottom layer is smaller than some of the visible layers, the final layer is clipped and trimmed to the size and position of the bottom layer.

Merge within active group only This self-explanatory option is enabled when a layer group exists.

Discard invisible layers When this option is checked, non visible layers are removed from the layer stack.

Figure 16.84 "Merge visible layers" example



16.6.26 Flatten Image

The Flatten Image command merges all of the layers of the image into a single layer with no alpha channel. After the image is flattened, it has the same appearance it had before. The difference is that all of the image contents are in a single layer without transparency. If there are any areas which are transparent through all of the layers of the original image, the background color is visible.

This operation makes significant changes to the structure of the image. It is normally only necessary when you would like to save an image in a format which does not support levels or transparency (an alpha channel).

16.6.26.1 Activate the Command

- You can access this command from the image menubar through Image → Flatten Image.

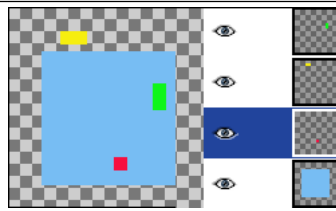
16.6.27 Align Visible Layers...

With the Align Visible Layers command, you can very precisely position the visible layers (those marked with the "eye" icon). This degree of precision is especially useful when you are working on animations, which typically have many small layers. Clicking on Align Visible Layers displays a dialog which allows you to choose how the layers should be aligned.

Note



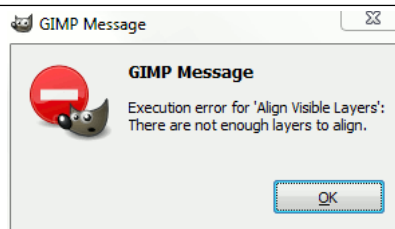
In GIMP 1.2, the default base for the alignment was the top visible layer in the stack. In GIMP 2, the default alignment base is the edge of the canvas. You can still align the image on the bottom layer of the stack, even if it is invisible, by checking Use the (invisible) bottom layer as the base in the dialog.

Figure 16.85 Example image for layer alignment

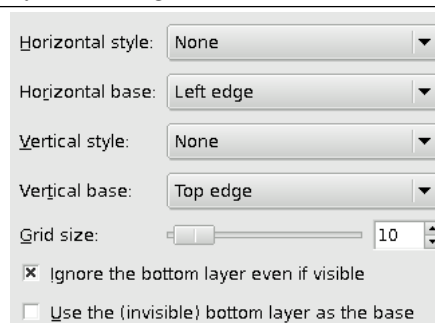
The example image contains four layers on a large (150x150 pixel) canvas. The red square is 10x10 pixels, the green rectangle is 10x20 pixels and the yellow rectangle is 20x10 pixels. The background layer (blue, 100x100 pixels) will not be affected by the command, since the Ignore lower layer option has been checked on the dialog. Note that the layers in the image seem to have a different order than their actual order in the stack because of their positions on the canvas. The yellow layer is the top layer in the image and the second one in the stack.

16.6.27.1 Activate the Command

- You can access this command from the image menubar through Image → Align Visible layers.... There is no default keyboard shortcut. If the image holds a single layer only, you get a message from GIMP telling that there must be more than one layer in the image to execute the command.

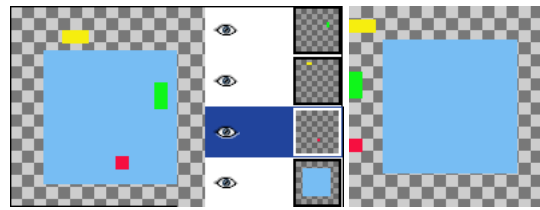
Figure 16.86 The "Not enough layers" message

16.6.27.2 Description of the "Align Visible Layers" dialog

Figure 16.87 The "Align Visible Layers" dialog

Horizontal Style; Vertical Style These options control how the layers should be moved in relationship to each other. You can choose:

- None: There will be no change in the horizontal or the vertical position, respectively.
- Collect: The visible layers will be aligned on the canvas, in the way that is determined by the Horizontal base and Vertical base options. If you select a Horizontal base of Right edge, layers may disappear from the canvas. You can recover them by enlarging the canvas. If you check the Use the (invisible) bottom layer as the base option, the layers will be aligned on the top left corner of the bottom layer.

Figure 16.88 Horizontal "Collect" alignment (on the edge of the canvas)

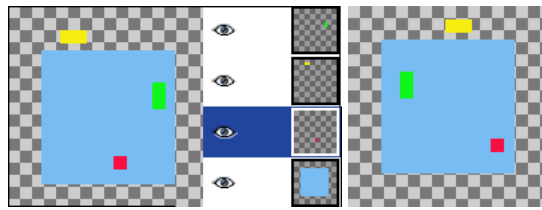
(a) Original image with the layer stack (b) The layers have been moved horizontally so that their left edges are aligned with the left edge of the canvas.

Figure 16.89 Horizontal "Collect" alignment (on the bottom layer)

(a) Original image with the layer stack (b) The layers have been moved horizontally so that their left edges align with the left edge of the bottom layer.

- Fill (left to right); Fill (top to bottom): The visible layers will be aligned with the canvas according to the edge you selected with Horizontal base or Vertical base, respectively. The layers are arranged regularly, so that they do not overlap each other. The top layer in the stack is placed on the leftmost (or uppermost) position in the image. The bottom layer in the stack is placed on the rightmost (or bottommost) position of the image. The other layers are placed regularly between these two positions. If the Use the (invisible) bottom layer as the base option is checked, the layers are aligned with the corresponding edge of the bottom layer.

Figure 16.90 Horizontal "Fill" alignment (canvas)



(a) Original image with the layer stack (b) Horizontal filling alignment, Left to Right, with Use the (invisible) bottom layer as the base option not checked. The top layer in the stack, the green one, is placed all the way on the left. The bottom layer in the stack, the red one, is placed on the right and the yellow layer is between the other two.

Figure 16.91 Horizontal "Fill" alignment (bottom layer)



(a) Original image with the layer stack (b) The same parameters as in the previous example, but with the lowest (blue) level as the base.

- Fill (right to left); Fill (bottom to top): These settings work similarly to the ones described above, but the filling occurs in the opposite direction.

Figure 16.92 Vertical "Fill" alignment (bottom layer)

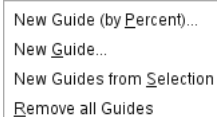


(a) Original image with the layer stack (b) Vertical "Fill" alignment, bottom to top, bottom layer as base

There must be at least three visible layers in the image to use the "Fill" options.

16.6.28 Guides

Figure 16.93 The "Guides" options of the "Image" submenu



The Guides submenu contains various commands for the creation and removal of guides.

16.6.28.1 Activating the Submenu

- You can access this submenu from the image menubar through Image → Guides.

16.6.28.2 The Contents of the "Guides" Submenu

The Guides submenu contains the following commands:

- Section [16.6.29](#)
- Section [16.6.30](#)
- Section [16.6.31](#)
- Section [16.6.32](#)

16.6.29 New Guide

The New Guide command adds a guide to the image.

Tip



You can add guides to the image more quickly, but less accurately, by simply clicking and dragging guides from the image rulers and positioning them where you would like.

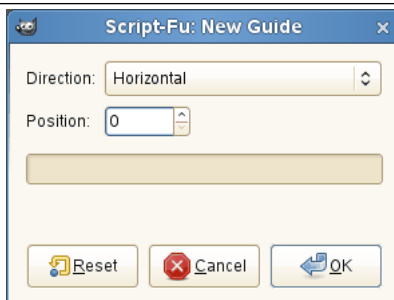
16.6.29.1 Activate the Command

You can access this command from the image menubar through Image → Guides → New Guide

16.6.29.2 "New Guide" Options

When you select New Guide, a dialog opens, which allows you to set the Direction and Position, in pixels, of the new guide more precisely than by using click-and-drag.

Figure 16.94 The "New Guide" Dialog



Direction You can choose the Direction of the guide, either Horizontal or Vertical, by using the drop-down list.

Position The coordinate origin for the Position is the upper left corner of the canvas.

16.6.30 New Guide (by Percent)

The New Guide (by Percent) command adds a guide to the image. The position of the guide is specified as a percentage of the canvas Height and Width.

Tip



You can add guides to the image more quickly by simply clicking and dragging guides from the image rulers and positioning them where you would like. Guides you draw with click-and-drag are not as precisely positioned as those you draw with this command, however.

16.6.30.1 Activate the Command

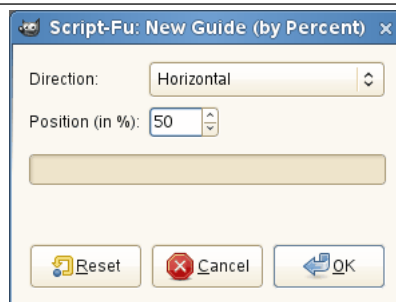
You can access this command from the image menubar through Image → Guides → New Guide (by Percent).

16.6.30.2 “New Guide (by Percent)” Options

When you select this menu item, a dialog opens, which allows you to set the Direction and Position, by percent, of the new guide.

This option is interesting if you want to place guides exactly at the middle of the image, using 50%.

Figure 16.95 The “New Guide (by Percent)” Dialog



Direction You can choose the Direction of the guide, either Horizontal or Vertical, by using the drop-down list.

Position You can also choose the Position of the new guide. The coordinate origin is in the upper left corner of the canvas.

16.6.31 New Guides from Selection

The New Guides from Selection command adds four guide lines, one for each of the upper, lower, left and right edges of the current selection. If there is no selection in the current image, no guides are drawn.

16.6.31.1 Activating the Command

You can access this command from the image menubar through Image → Guides → New Guides from Selection.

16.6.32 Remove all guides

The Remove all Guides command removes all guides from the image. Clicking-and-dragging one or two guides onto a ruler is a quicker way to remove them. This command is useful if you have positioned several guides.

16.6.32.1 Activate the Command

You can access this command from the image menubar through Image → Guides → Remove all guides.

16.6.33 Configure Grid...

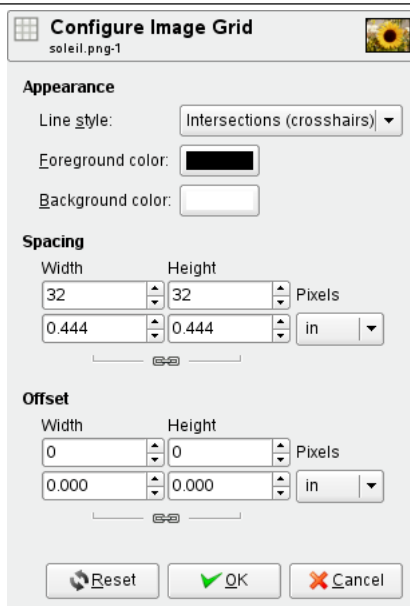
The Configure Grid command lets you set the properties of the grid which you can display over your image while you are working on it. The GIMP provides only Cartesian grids. You can choose the color of the grid lines, and the spacing and offsets from the origin of the image, independently for the horizontal and vertical grid lines. You can choose one of five different grid styles.

16.6.33.1 Activating the Command

- You can access this command from the image menubar through Image → Configure Grid....

16.6.33.2 Description of the “Configure Image Grid” dialog

Figure 16.96 The “Configure Grid” dialog



Appearance

In the Configure Grid dialog, you can set the properties of the grid which is shown when you turn on the image grid.

Line style

Intersections (dots) This style, the least conspicuous, shows a simple dot at each intersection of the grid lines.

Intersections (crosshairs) This style, the default, shows a plus-shaped crosshair at each intersection of the grid lines.

Dashed This style shows dashed lines in the foreground color of the grid. If the lines are too close together, the grid won't look good.

Double dashed This style shows dashed lines, where the foreground and background colors of the grid alternate.

Solid This style shows solid grid lines in the foreground color of the grid.

Foreground and Background colors Click on the color dwell to select a new color for the grid.

Spacing

Width and Height You can select the cell size of the grid and the unit of measurement.

Offset

Width and Height You can set the offset of the first cell. The coordinate origin is the upper left corner of the image. By default, the grid begins at the coordinate origin, (0,0).

16.6.34 Image Properties

The "Image Properties" command opens a window that shows lots of different information for the image.

16.6.34.1 Activate the Command

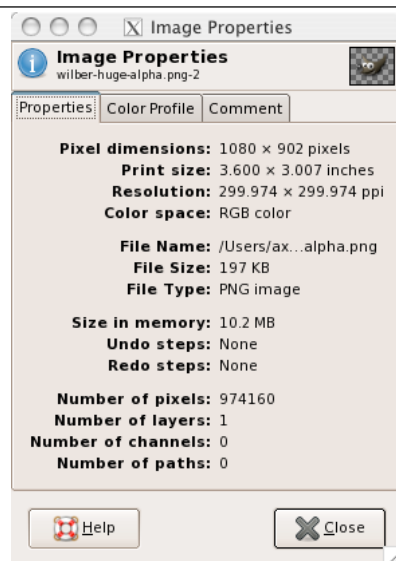
- You can access this command from the image menubar through Image → Image Properties,
- or by using the keyboard shortcut Alt-Return.

16.6.34.2 Options

The properties window is divided into three tabs.

16.6.34.2.1 "Properties" tab

Figure 16.97 "Properties" tab



Pixel dimensions Shows the image height and width in pixels, that is, the *physical* size of the image.

Print size Shows the size the image will have when it is printed, in the current units. This is the *logical* size of the image. It depends upon the physical size of the image and the screen resolution.

Resolution Shows the print resolution of the image in pixel per inch.

Color space Shows the images color space.

File name Path and name of the file that contains the image.

File size Size of the file that contains the image.

File type Format of the file that contains the image.

Size in memory RAM consumption of the loaded image including the images journal. This information is also displayed in the image window. The size is quite different from the size of the file on disk. That is because the displayed image is decompressed and because GIMP keeps a copy of the image in memory for Redo operations.

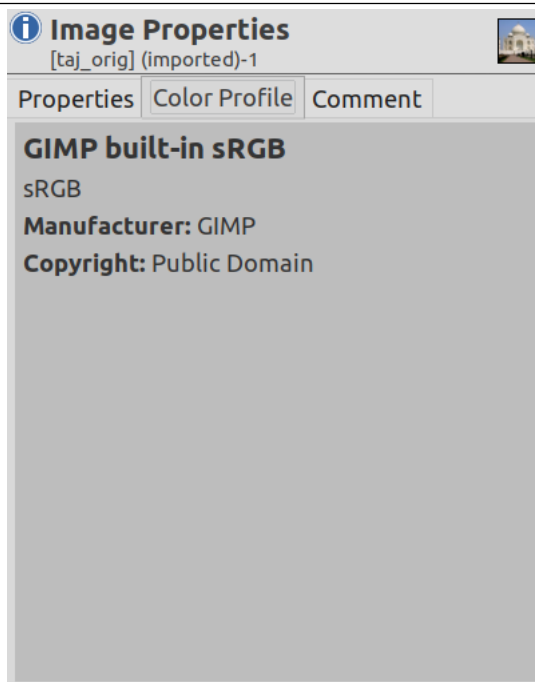
Undo steps Number of actions you have performed on the image, that you can undo. You can see them in the **Undo History** dialog.

Redo steps Number of actions you have undone, that you can redo.

Number of pixels; Number of layers; Number of channels; Number of paths Well counted!

16.6.34.2.2 "Color profile" tab

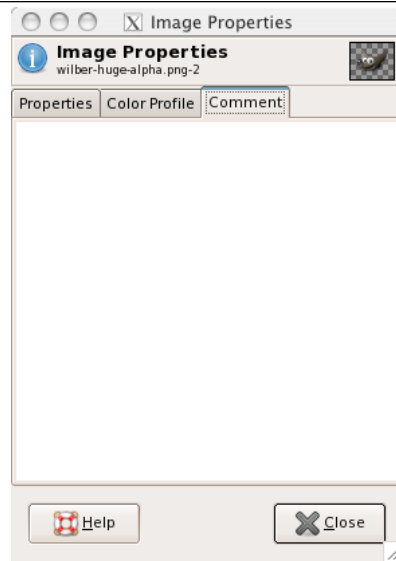
Figure 16.98 "Color profile" tab



This tab contains the name of the color profile the image is loaded into GIMP with. Default is the built-in "sRGB" profile.

16.6.34.2.3 "Comments" tab

Figure 16.99 "Comments" tab



This tab allows you to view and edit a comment for the image.

16.6.35 Metadata

Figure 16.100 The "Metadata" submenu of the "Image" menu

Edit Metadata
View Metadata

Metadata are information about a document, embedded in the document. For GIMP, they are *image metadata*.

Note



PNG, JPEG, TIFF and WebP preserve existing metadata.

You can set defaults to enable or disable exporting metadata in all affected file formats on whether you want complete privacy or not. Settings are available in Edit/Preferences/Image Import and Export/Export Policies.

16.6.35.1 Activating the Metadata command

- You can access this command from the image menubar through Image → Metadata.

16.6.35.2 The Metadata Submenu

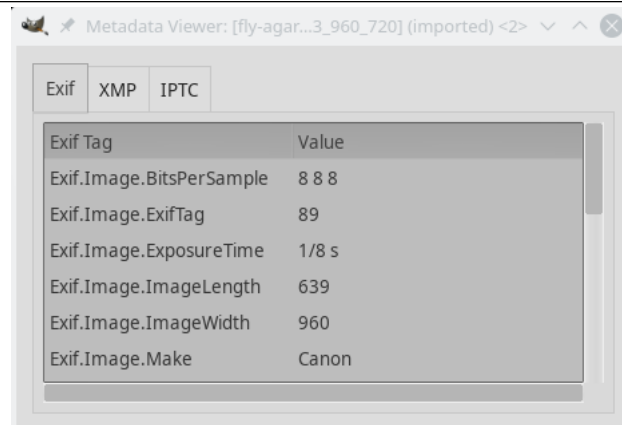
GIMP uses two plug-ins:

- Metadata Viewer.**
- Metadata Editor.**

16.6.36 Metadata Viewer

View Exif, IPTC, XMP metadata.

Figure 16.101 “Metadata Viewer” dialog



16.6.36.1 Activating the Submenu

You can access this submenu from the image menubar through Image → Metadata → Metadata Viewer.

16.6.36.2 “Metadata Viewer” Options

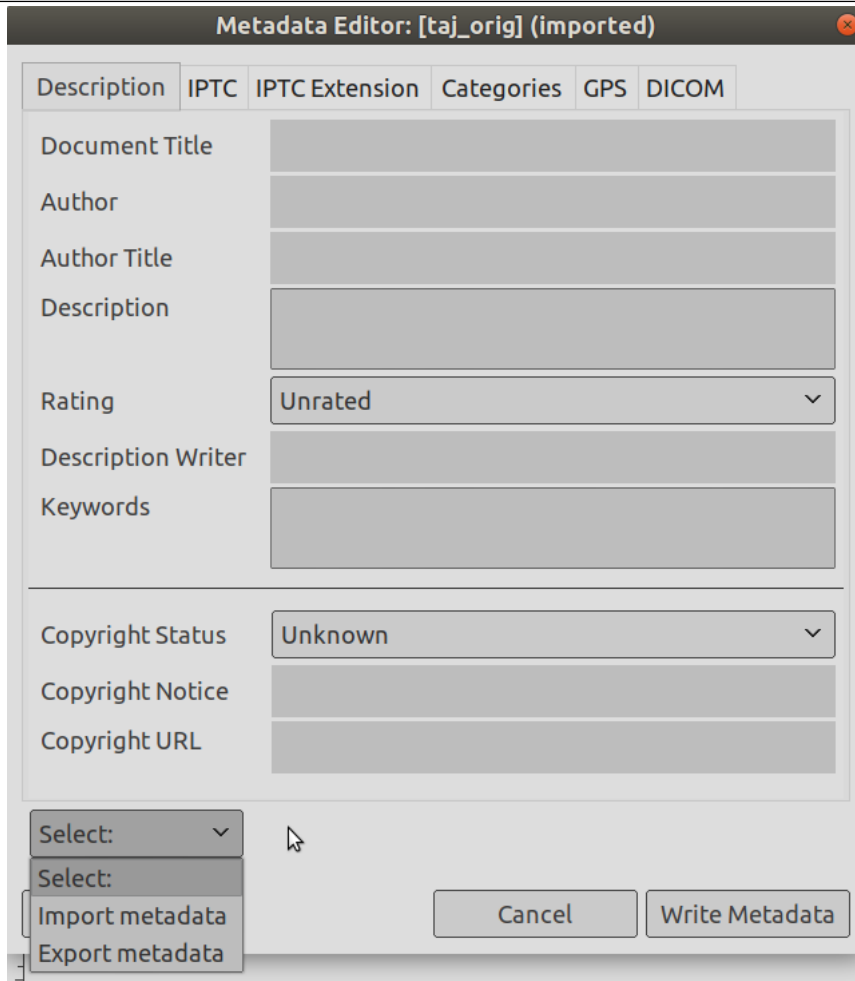
Three tabs:

- Exif: see [EXIF](#)
- IPTC: see [IPTC](#)
- XMP: see [XMP](#)

16.6.37 Metadata Editor

Edit Exif, IPTC, XMP metadata.

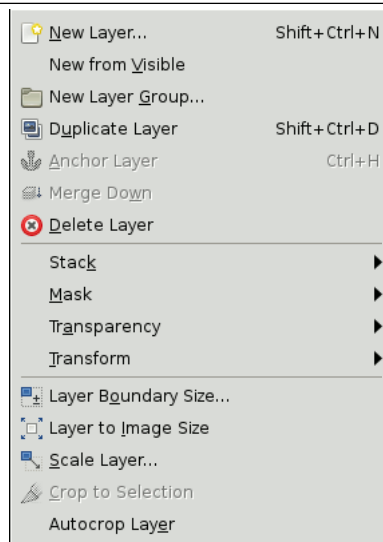
Figure 16.102 "Metadata Editor" dialog



16.7 The "Layer" Menu

16.7.1 Introduction to the "Layer" Menu

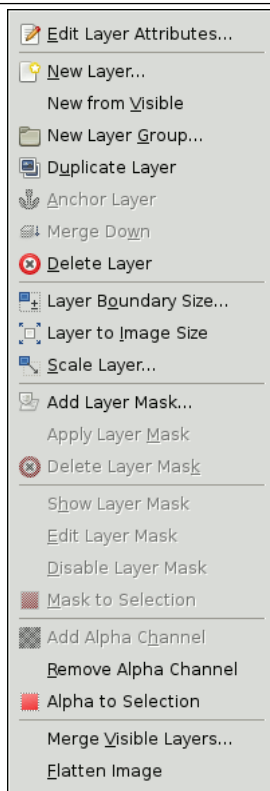
Figure 16.103 The Contents of the "Layer" Menu



The items on the Layer menu allow you to work on layers.

In addition to accessing the Layer menu from the Image menubar and by right-clicking on the image window, you can get to it by right-clicking on the thumbnail of a layer in the Layers dialog. You can also perform several of the operations on this menu by clicking on buttons in the Layers dialog, for example, resizing a layer, managing layer transparency and merging layers.

Figure 16.104 The Contents of the “Layer” local pop-menu



Note



Besides the commands described here, you may also find other entries in the menu. They are not part of GIMP itself, but have been added by extensions (plug-ins). You can find information about the functionality of a Plugin by referring to its documentation.

16.7.2 New Layer

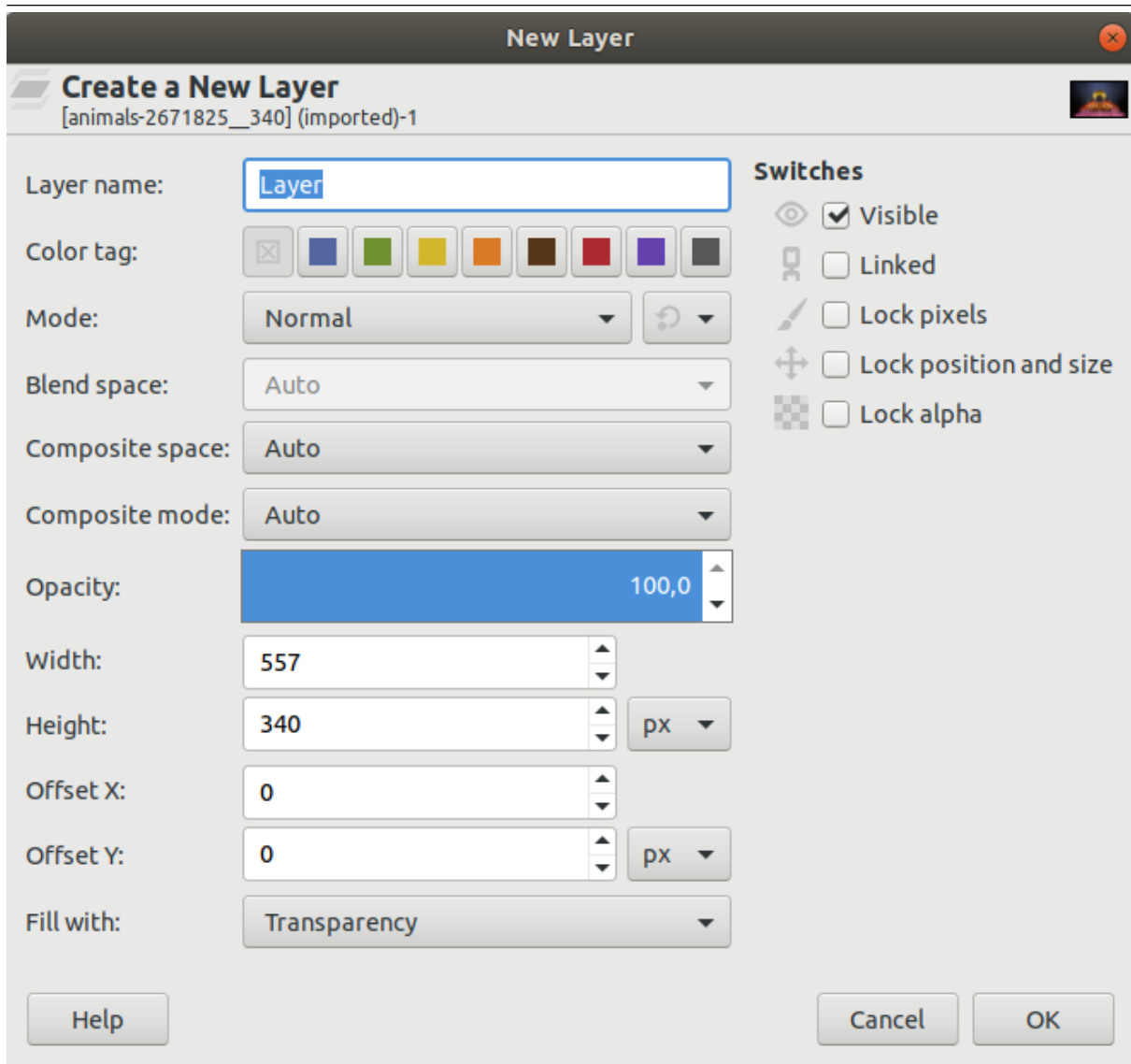
The New Layer... command opens the “Create a New Layer” dialog that allows you to add a new, empty layer to the layer stack of the image, just above the active layer.

16.7.2.1 Activating the Command

- You can access this command from the image menubar through Layer → New Layer..., or by clicking on the dedicated button in the layer dialog.

16.7.2.2 Description of the "New Layer" Dialog

Figure 16.105 The "New Layer" dialog



Under the title "Create a new layer" you can see the name of the image for that you create this new layer and next to the title a thumbnail of it. That is interesting to see if you have selected the good image when there is more than one image open.

Layer Name The name of the new layer. It does not have any functional significance; it is simply a convenient way for you to remember the purpose of the layer. The default name is "New Layer". If a layer with the name you choose already exists, a number is automatically appended to it to make it unique (e.g., "New Layer#1") when you click on the OK button.

Color tag If you click on one of these color buttons, the "Eye" icon box of the created layer will have this color. This is interesting when you have many layers in the image.

Mode Default is "Normal". The drop-down list offers all layer blend modes. On the right, another drop-down list to select between "Default" or "Legacy" group of modes.

Layer blend modes are described in [Layer Modes](#).

Blend space The space used by the layer mode. This option is not activated.

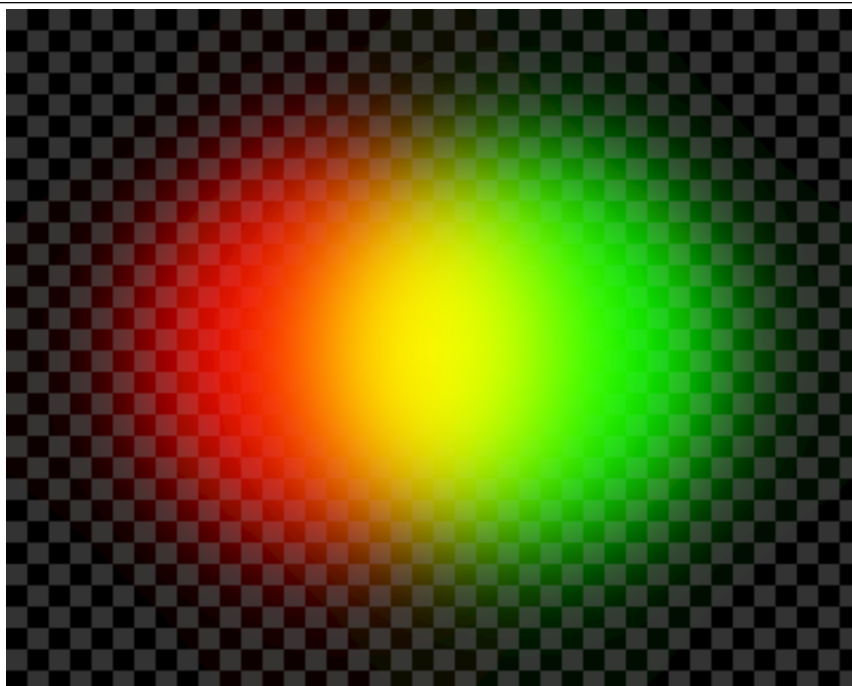
Composite mode The **layer’s mode** (sometimes referred to as its “blend mode”: Normal, Multiply, etc.) determines how the *color values* of the layer and its backdrop are combined, while the **layer’s composite mode** determines how the *alpha values* of the layer and its backdrop are combined. (The layer’s backdrop is the content against which the layer is composited; namely, it’s the combination of the layers below it.)

There are two regions of interest when compositing the layer against its backdrop: the opaque region of the backdrop, and the opaque region of the layer. The layer’s blend mode determines how to combine the colors of the *intersection* of these two regions: i.e., the common opaque region of both the backdrop and the layer (pixels belonging to only one of these regions don’t need to be combined with anything, and retain their original color.). The layer’s composite mode determines which part of these regions to keep, and which to discard.

The example images below show the composition of two layers -- the bottom layer containing a red feathered circle, and the top layer containing a green feathered circle -- using “Addition” mode, and different composite modes (applied to the top layer).

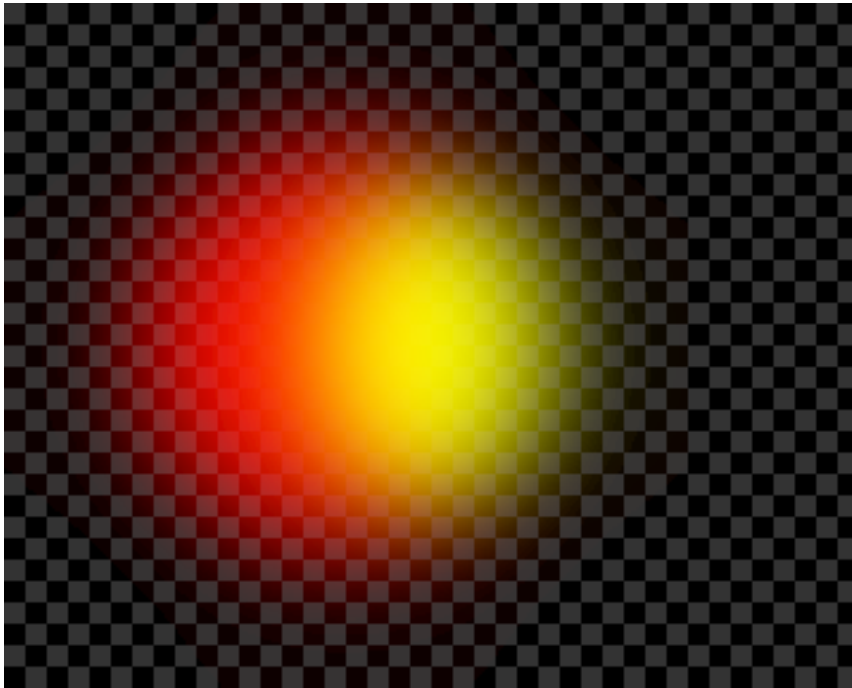
- Union: keeps the opaque regions of both the layer and its backdrop, i.e their union.

Figure 16.106 “Union” option example



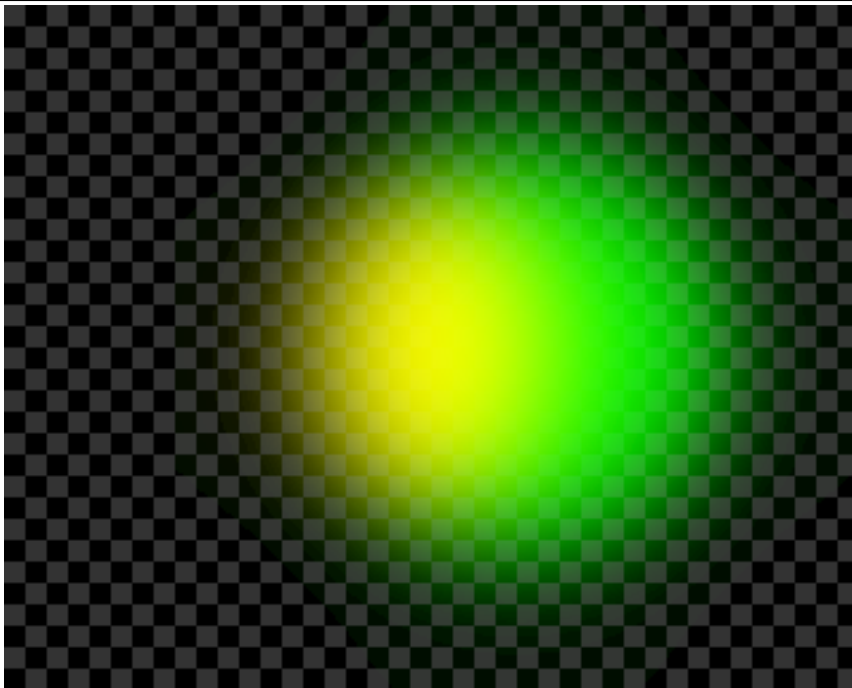
- Clip to backdrop: keeps only the opaque regions of the backdrop (this includes the common opaque region to both the backdrop and the layer i.e their intersection).

Figure 16.107 "Clip to backdrop" option example

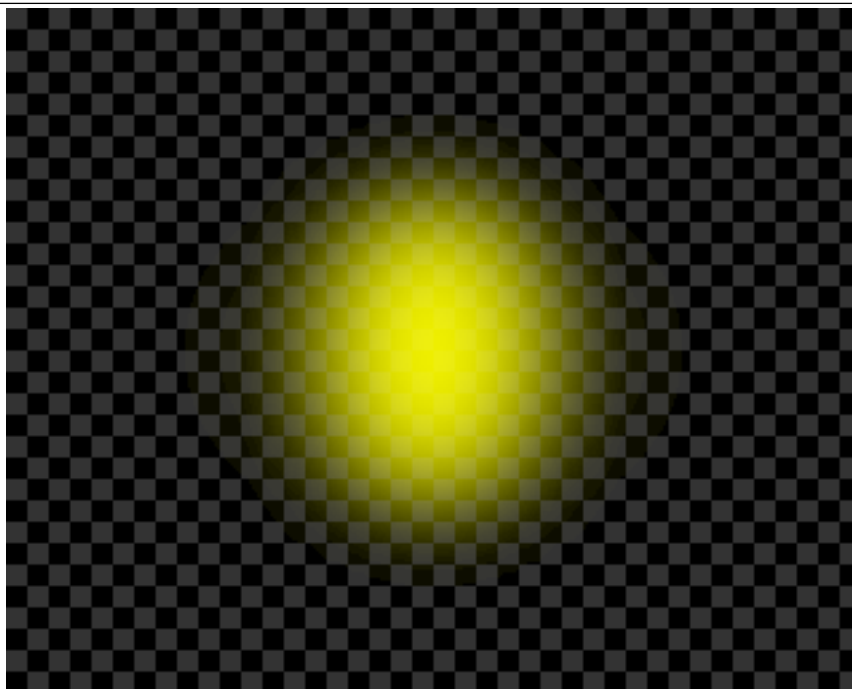


-
- Clip to layer: keeps only the opaque region of the layer (this includes the common opaque region to both the backdrop and the layer, i.e their intersection).

Figure 16.108 "Clip to layer" option example



-
- Intersection: keeps only the opaque region to both the backdrop and the layer, i.e their intersection.

Figure 16.109 “Intersection” option example

- Auto: “Auto” mode is not a separate composite mode, but rather corresponds to one of the other composite modes, depending on the layer’s blend mode: for “Normal”, “Dissolve”, and “Merge”, it corresponds to “Union”, and for the other modes (that support different composite modes) it corresponds to “Clip to Backdrop”.

Composite space Default is “Auto”. In the drop-down list, you can choose between “RGB linear” and “RGB perceptual”.

Channel encodings are described in [Glossary](#).

Opacity Sets the opacity of painting on the layer. Default is 100%.

Width; Height The dimensions of the new layer. When the dialog appears, the values are initialized to the dimensions of the image. You can change them by using the two text boxes. You can also change the units in the pull-down menu to the right.

Offset X; Y The origin of the new layer is the upper left corner of the image. Here, you can set precisely the position of layers smaller than the canvas, especially text layers.

Fill With There are five options for the solid color that fills the layer: the current Foreground color, the current Background color, White, Transparency, and Pattern.

Switches These switches reproduce options described in the [Layer Dialog](#).

16.7.3 New Layer Group

This command creates a new layer group directly. Please refer to Section [8.4](#).

16.7.3.1 Activating the Command

- You can access this command from an image menu through Layer → New Layer Group..., or from the layer context menu you get by right clicking on the layer dialog.

16.7.4 New From Visible

This command merges the visible layers into a new layer at the top of the layer stack.

The aim is to further manipulate the result, but keep the steps that created this situation. Example: You want to selectively blur some areas of your multilayer image. You create a new layer from what you see, blur it and then apply a layer mask to erase the parts you want your original work to show.

16.7.4.1 Activating the Command


- You can access this command from the image menubar through Layer → New From Visible.

16.7.5 Duplicate layer

The Duplicate Layer command adds a new layer to the image which is a nearly identical copy of the active layer. The name of the new layer is the same as the name of the original layer, but with " copy" appended to it.

If you duplicate a background layer which does not have an alpha channel, the new layer is provided with one. In addition, if there are any "parasites" attached to the active layer, they are not duplicated. (If your understanding of the word "parasites" is limited to small, unpleasant creatures, please ignore the last sentence.)

16.7.5.1 Activate the Command

- You can access this command from the image menubar through Layer → Duplicate Layer, or from the local pop-up menu that you get by right-clicking on the Layer Dialog.
- In addition, at the [Layer Dialog](#), you can access it through Duplicate of its context pop-up menu, or clicking on the  icon button on the bottom of this dialog.

16.7.6 Anchor layer

If you have created a floating selection, a temporary layer, called a "floating layer" or "floating selection", is added to the layer stack. As long as the floating layer persists, you can work only on it. To work on the rest of the image, you must "anchor" the floating layer to the former active layer with the Anchor layer command. If the image does not contain a floating selection, this menu entry is disabled.

Note



If there is an active selection tool, the mouse pointer is displayed with an anchor icon when it is outside of the selection.

16.7.6.1 Activate the Command

- You can access this command from the image menubar through Layer → Anchor layer,
- or by using the keyboard shortcut Ctrl-H.

16.7.6.2 Alternative Ways of Anchoring a Floating Selection

Please refer to Section [16.4.5.3](#)

16.7.7 Merge Down

The Merge Down command merges the active layer with the layer just below it in the stack, taking into account the various properties of the active layer, such as its opacity and layer **mode**. The resulting merged layer will be in Normal mode, have opacity set to 100%, and will have an alpha channel even if the original layers didn’t have one. If the layer below is not opaque, or if it is in some mode other than Normal, then this command will generally change the appearance of the image.

The most common use of Merge Down is to construct a layer, by starting with a “base layer” (usually opaque and in Normal mode, so that you can see what you are doing), and adding a “modification layer” on top of it, with whatever shape, opacity, and layer mode you need. In this case, merging down the modification layer will combine the two layers into one, without changing the way the image looks.

16.7.7.1 Activating the Command

- You can access this command from the image menubar through Layer → Merge Down.

16.7.8 Delete Layer

The Delete Layer command deletes the current layer from the image.

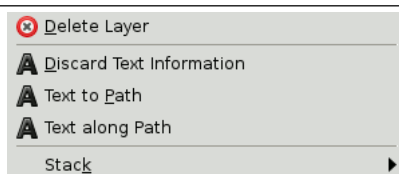
16.7.8.1 Activate the Command

- You can access this command from the image menubar through Layer → Delete Layer.
- In addition, at the **Layer Dialog**, you can access it through Delete Layer of its context pop-up menu, or clicking on the ✕ icon button on the bottom of this dialog.

16.7.9 The Text Commands of the Layer Menu

These commands are displayed only if a text layer is present.

Figure 16.110 Text commands in the Layer menu



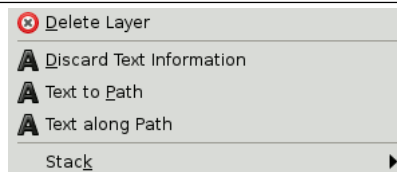
16.7.9.1 The Text Commands

- Section [16.7.10](#)
- [Text to Path](#)
- [Text along Path](#)
- In the Text to Selection drop-down list, the commands are identical to those of the Transparency sub-menu (in fact, the text is formed of areas of different transparency):
 - **Text to Selection:** Section [16.7.38](#)
 - **Add to Selection:** Section [16.7.39](#)
 - **Subtract from Selection:** Section [16.7.40](#)
 - **Intersect with Selection:** Section [16.7.41](#)

16.7.10 Discard Text Information

This command belongs to a group of Text commands displayed only if a text layer is present.

Figure 16.111 The Discard Text command among text commands in the Layer menu



When you add text to an image, GIMP adds specific information. This command lets you discard this information, transforming the current text layer into a normal bitmap layer. The reason to do that is not evident.

Note that this transformation of text into bitmap is automatically performed when you apply a graphic operation to the text layer. You can get text information back by undoing the operation which modified the text.

16.7.10.1 Activating the Command

- You can access this command from the image menubar through Layer → Discard Text Information.

16.7.11 "Stack" Submenu

Figure 16.112 The "Stack" submenu



The layer stack is simply the list of layers in the Layers dialog. The Stack submenu contains operations which either select a new layer as the active layer, or change the position of the active layer in the layer stack. If your image has only one layer, these commands are grayed out.

16.7.11.1 Activating the Submenu

- You can access this submenu from the image menubar through Layer → Stack.

16.7.11.2 The Contents of the "Stack" Submenu

The Stack submenu contains the following commands:

- Section [16.7.12](#)
- Section [16.7.13](#)
- Section [16.7.14](#)
- Section [16.7.15](#)
- Section [16.7.16](#)
- Section [16.7.17](#)

- Section 16.7.18
- Section 16.7.19
- Section 16.7.20

16.7.12 Select Previous Layer

The Select Previous Layer command selects the layer just above the active layer in the layer stack. The command highlights the layer in the Layers Dialog and makes it the new active layer. If the active layer is already at the top of the stack, this menu entry is disabled.

Note



Note that on a standard Windows-style English keyboard, the default shortcut **Page Up** does not refer to the key on the numeric keypad, but to the other **Page Up** key in the group of six keys to the left of the numeric keypad.

Tip



The keyboard shortcuts for Select Previous Layer and Select Next Layer may be very useful if you frequently pick colors from one layer to use for painting on another layer, especially when you use them with the color-picker tool, which you get by holding down the **Ctrl** key with most of the painting tools.

16.7.12.1 Activating the Command

- You can access this command from the image menubar through Layer → Stack → Select Previous Layer,
- or by using the keyboard shortcut **Up**.

Or you simply click the layer name in the Layers Dialog.

16.7.13 Select Next Layer

The Select Next Layer command selects the layer just underneath the active layer in the layer stack. The command highlights the layer in the Layers Dialog and makes it the new active layer. If the active layer is already at the bottom of the stack, this menu entry is disabled.

Note



Note that on a standard Windows-style English keyboard, the default shortcut **Page Down** does not refer to the key on the numeric keypad, but to the other **Page Down** key in the group of six keys to the left of the numeric keypad.

16.7.13.1 Activating the Command

- You can access this command from the image menubar through Layer → Stack → Select Next Layer,
- or by using the keyboard shortcut **Down**.

Or you simply click the layer name in the Layers Dialog.

16.7.14 Select Top Layer

The Select Top Layer command makes the top layer in the stack the active layer for the image and highlights it in the Layers dialog. If the active layer is already the top layer in the stack, this menu entry is disabled.

Note



Note that on a standard Windows-style English keyboard, the default keyboard shortcut **Home** does not refer to the key on the numeric keypad, but to the other **Home** key in the group of six keys to the left of the numeric keypad.

16.7.14.1 Activating the Command

- You can access this command from the image menubar through Layer → Stack → Select Top Layer,
- or by using the keyboard shortcut **Home**.

Or you simply click the layer name in the Layers Dialog.

16.7.15 Select Bottom Layer

With the Select Bottom Layer command, you can make the bottom layer in the stack become the active layer for the image. It is then highlighted in the Layers dialog. If the bottom layer of the stack is already the active layer, this menu entry is insensitive and grayed out.

16.7.15.1 Activate the Command

- You can access this command from the image menubar through Layer → Stack → Select Bottom Layer,
- by using the keyboard shortcut **End**.

Or you simply click on the layer name in the Layers Dialog.

16.7.16 Raise Layer

The Raise Layer command raises the active layer one position in the layer stack. If the active layer is already at the top or if there is only one layer, this menu entry is disabled. If the active layer is at the bottom of the stack and it does not have an alpha channel, it cannot be raised until you add an alpha channel to it.

16.7.16.1 Activating the Command

- You can access this command from the image menubar through Layer → Stack → Raise Layer,
- or by clicking the up-arrow icon at the bottom of the Layers dialog.

16.7.17 Lower Layer

The Lower layer command lowers the active layer one position in the layer stack. If the active layer is already at the bottom of the stack or if there is only one layer, this menu entry is insensitive and grayed out.

16.7.17.1 Activating the Command

- You can access this command from the image menubar through Layer → Stack → Lower Layer,
- or by clicking on the down-arrow icon at the bottom of the Layers dialog.

16.7.18 Layer to Top

The Layer to Top command raises the active layer to the top of the layer stack. If the active layer is already at the top or if there is only one layer, this menu entry is insensitive and grayed out. If the active layer is at the bottom of the stack and it does not have an alpha channel, you cannot raise it until you add an alpha channel to it.

16.7.18.1 Activating the Command

- You can access this command from the image menubar through Layer → Stack → Layer to Top,
- or by pressing the **Shift** key and clicking on the up-arrow icon at the bottom of the Layers dialog.

16.7.19 Layer to Bottom

The Layer to bottom command lowers the active layer to the bottom of the layer stack. If the active layer is already at the bottom of the stack or if there is only one layer, this menu entry is insensitive and grayed out.

16.7.19.1 Activating the Command

- You can access this command from the image menubar through Layer → Stack → Layer to Bottom,
- or by pressing the **Shift** key and clicking on the down-arrow icon at the bottom of the Layers dialog.

16.7.20 The “Reverse Layer Order” command

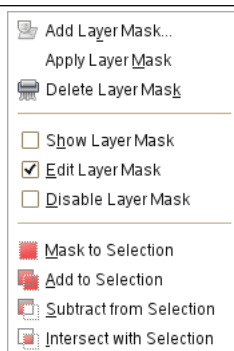
This command is self-explanatory.

16.7.20.1 Activating the command

- From the image Menu through: Layers → Stack → Reverse Layer Order.

16.7.21 The “Mask” Submenu

Figure 16.113 The “Mask” submenu of the “Layer” menu



The Mask submenu of the Layer menu contains commands which work with masks: creating a mask, applying a mask, deleting a mask or converting a mask into a selection. See the [Layer Masks](#) section for more information on layer masks and how to use them.

16.7.21.1 Activating the Submenu

- You can access this submenu from the image menubar through Layer → Mask

16.7.21.2 The Contents of the “Mask” Submenu

The Mask submenu contains the following commands:

- Section [16.7.22](#)
- Section [16.7.23](#)
- Section [16.7.24](#)
- Section [16.7.25](#)
- Section [16.7.26](#)
- Section [16.7.27](#)
- Section [16.7.28](#)
- Section [16.7.29](#)
- Section [16.7.30](#)
- Section [16.7.31](#)

16.7.22 Add Layer Mask

The Add Layer Mask command adds a layer mask to the active layer. It displays a dialog in which you can set the initial properties of the mask. If the layer already has a layer mask, the menu entry is insensitive and grayed out.

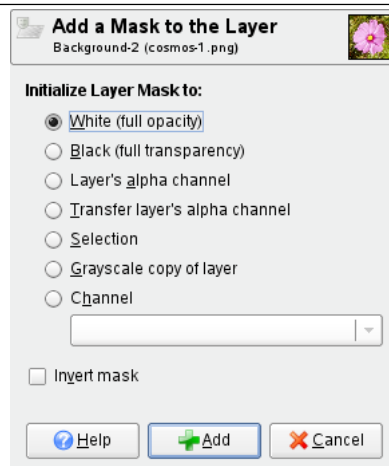
A layer mask lets you define which parts of the layer are opaque, semi-transparent or transparent. See the [Layer Mask](#) section for more information.

16.7.22.1 Activating the Command

- You can access this command from the image menubar through Layer → Mask → Add Layer Mask
- or from the pop-up menu you get by right-clicking on the active layer in the Layers Dialog.

16.7.22.2 Description of the “Add Layer Mask” Dialog

Figure 16.114 The “Add Layer Mask” dialog



Initialize Layer Mask to This dialog allows you several choices for the initial contents of the layer mask:

White (full opacity) With this option, the layer mask will make all of the layer fully opaque. That means that you will not notice any difference in the appearance of the layer until you paint on the layer mask.

Black (full transparency) With this option, the layer mask will make all of the layer fully transparent. This is represented in the image by a checkered pattern on which you will need to paint to make any part of the layer visible.

Layer’s alpha channel With this option, the contents of the alpha channel are used to fill the layer mask. The alpha channel itself is not altered, so the transparency of partially visible areas is increased, leading to a more transparent layer.

Transfer layer’s alpha channel This option sets the layer mask as the previous option, but resets the layer’s alpha channel to full opacity afterwards. The effect is to transfer the transparency information from the alpha channel to the layer mask, leaving the layer with the same appearance as before. The visibility of the layer is now determined by the layer mask alone and not by the alpha channel. If in doubt, select this option instead of “Layer’s alpha channel”, because it will leave the appearance unaltered.

Selection This option converts the current selection into a layer mask, so that selected areas are opaque, and unselected areas are transparent. If any areas are partially selected, you can click on the **QuickMask** button to help you predict what the effects will be.

Grayscale copy of layer This option converts the layer itself into a layer mask. It is particularly useful when you plan to add new contents to the layer afterwards.

Channel With this option the layer mask is initialized with a selection mask you have created before, stored in the Channel dialog.

Invert Mask If you check the Invert Mask box at the bottom of the dialog, the resulting mask is inverted, so that transparent areas become opaque and vice versa.

When you click on the OK button, a thumbnail of the layer mask appears to the right of the thumbnail of the layer in the Layers Dialog.

16.7.23 Apply Layer Mask

The Apply Layer Mask command merges the layer mask with the current layer. The transparency information in the layer mask is transferred to the alpha channel, that is created if it doesn’t exist, and the layer mask is removed. If the active layer does not have a layer mask, the menu entry is insensitive and grayed out. See the **Layer Masks** section for more information.

16.7.23.1 Activating the Command

- You can access this command from the image menubar through Layer → Mask → Apply Layer Mask,
- or from the pop-up menu you get by right-clicking on the active layer in the Layers Dialog.

16.7.24 Delete Layer Mask

The Delete Layer Mask command deletes the active layer’s layer mask, without modifying the active layer itself. If the active layer does not have a layer mask, the menu entry is insensitive and grayed out.

16.7.24.1 Activating the Command

- You can access this command from the image menubar through Layer → Mask → Delete Layer Mask,
- or from the pop-up menu you get by right-clicking on the active layer in the Layers Dialog.

16.7.25 Show Layer Mask

The Show Layer Mask command lets you see the layer mask better by turning the image invisible. When you click on the menu entry, a check is displayed next to it and the layer mask’s thumbnail in the Layers Dialog is shown with a green border. The layer itself is not modified; you can turn it visible again later.

16.7.25.1 Activating the Command

- You can access this command from the image menubar through Layer → Mask → Show Layer Mask,
- or by holding down the **Alt** key (Ctrl-Alt on some systems) and single-clicking on the layer mask's thumbnail in the Layers Dialog.
- You can undo this action by unchecking the menu entry in the Layer → Mask submenu or by **Alt**-clicking (or Ctrl-Alt-clicking) again on the layer mask's thumbnail.

16.7.26 Edit Layer Mask

When you click on the Edit Layer Mask item on the Layer Mask submenu, a check is displayed next to it, the layer mask becomes the active component of the current layer and the layer mask is displayed in the Layers Dialog with a white border. When you uncheck it, the layer itself becomes the active component and it is displayed with a white border. You can also activate the component you want more simply by clicking on it in the Layers Dialog.

16.7.26.1 Activating the Command

- You can access this command from the image menubar through Layer → Mask → Edit Layer Mask.
- You can undo this action by unchecking the menu entry in the Layer → Mask menu or by clicking on the layer component in the Layers Dialog.

16.7.27 Disable Layer Mask

As soon as you create a layer mask, it acts on the image. The Disable Layer Mask command allows you to suspend this action. When you click on the menu entry, a check is displayed next to it and the border of the layer mask's thumbnail in the Layers Dialog turns red.

16.7.27.1 Activating the Command

- You can access this command from the image menubar through Layer → Mask → Disable Layer Mask,
- or by holding down the **Ctrl** key (Ctrl-Alt on some systems) and single-clicking on the layer mask's thumbnail in the Layers Dialog.
- You can undo this action by unchecking the menu entry in the Layer → Mask menu or by **Ctrl**-clicking (or Ctrl-Alt -clicking) again on the layer mask's thumbnail.

16.7.28 Mask to Selection

The Mask to Selection command converts the layer mask of the active layer into a selection, which replaces the selection that is already active in the image. White areas of the layer mask are selected, black areas are not selected, and gray areas are converted into feathered selections. The layer mask itself is not modified by this command.

16.7.28.1 Activating the Command

- You can access this command from the image menubar through Layer → Mask → Mask to Selection,
- or from the pop-up menu you get by right-clicking on the active layer in the Layers Dialog.

16.7.28.2 Illustration of "Layer Mask to Selection"

Figure 16.115 Illustration of "Layer Mask to Selection"



On the left, the original image with a selection. In the middle, the Layers Dialog with a layer mask created with the "Layer's alpha channel" option. On the right, the result after applying "Mask to Selection": the selection of the non-transparent pixels of the active layer replaces the initial selection.

16.7.29 Add Layer Mask to Selection

The Add to Selection command converts the layer mask of the active layer into a selection, which is added to the selection that is already active in the image. White areas of the layer mask are selected, black areas are not selected, and gray areas are converted into feathered selections. The layer mask itself is not modified by this command.

16.7.29.1 Activating the Command

- You can access this command from the image menubar through Layer → Mask → Add to Selection,

16.7.29.2 Illustration of Add Layer Mask to Selection

Figure 16.116 Illustration of Add Layer Mask to Selection



On the left, the original image with a selection. In the middle, the Layers Dialog with a layer mask created with the "Layer's alpha channel" option. On the right, the result after applying "Mask to Selection": the selection of the non-transparent pixels of the active layer is added to the initial selection.

16.7.30 Subtract Layer Mask from Selection

The Subtract from Selection command converts the layer mask of the active layer into a selection, which is subtracted from the selection that is already active in the image. White areas of the layer mask are selected, black areas are not selected, and gray areas are converted into feathered selections. The layer mask itself is not modified by this command.

16.7.30.1 Activating the Command

- You can access this command from the image menubar through Layer → Mask → Subtract from Selection,

16.7.30.2 Illustration of Subtract Layer Mask from Selection

Figure 16.117 Illustration of Subtract Layer Mask from Selection



On the left, the original image with a selection. In the middle, the Layers Dialog with a layer mask created with the "Layer's alpha channel" option. On the right, the result after applying "Mask to Selection": the selection of the non-transparent pixels of the active layer is subtracted from the initial selection.

16.7.31 Intersect Layer Mask with Selection

The Intersect with Selection command converts the layer mask of the active layer into a selection. The intersection of this selection and the selection that is already active form the new selection for the image. White areas of the layer mask are selected, black areas are not selected, and gray areas are converted into feathered selections. The layer mask itself is not modified by this command.

16.7.31.1 Activating the Command

- You can access this command from the image menubar through Layer → Mask → Intersect with Selection,

16.7.31.2 Illustration of Intersecting the Layer Mask with the Selection

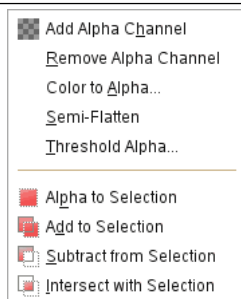
Figure 16.118 Illustration of Intersecting the Layer Mask with the Selection



On the left, the original image with a selection. In the middle, the Layers Dialog with a layer mask created with the "Layer's alpha channel" option. On the right, the result after applying "Intersect Mask with Selection": the selection of the non-transparent pixels of the active layer is the common part between the initial selection and the mask.

16.7.32 The "Transparency" Submenu of the "Layer" menu

Figure 16.119 The "Transparency" submenu of the "Layer" menu



The Transparency submenu contains commands which use or affect the alpha channel of the active layer.

16.7.32.1 Activating the Submenu

- You can access this submenu from the image menu bar through Layer → Transparency.

16.7.32.2 The Contents of the "Transparency" Submenu

The Transparency submenu contains the following commands:

- Section [16.7.33](#)
- Section [16.7.34](#)
- Section [16.7.35](#)
- Section [16.7.36](#)
- Section [16.7.37](#)
- Section [16.7.38](#)
- Section [16.7.39](#)
- Section [16.7.40](#)
- Section [16.7.41](#)

16.7.33 Add Alpha Channel

Add Alpha Channel: An alpha channel is automatically added into the Channel Dialog as soon as you add a second layer to your image. It represents the transparency of the image. If your image has only one layer, this background layer has no Alpha channel. In this case, you can Add an Alpha channel with this command.

16.7.33.1 Activate the Command

- You can access this command from the image menubar through Layer → Transparency → Add Alpha Channel.
- In addition, at the [Layer Dialog](#), you can access it through Add Alpha Channel of its context pop-up menu.

16.7.34 Remove Alpha Channel

This command removes the Alpha channel of the active layer, keeping the Alpha channels of the other layers.

If the active layer is the background layer and if you have not added an Alpha channel before (then the layer name is in bold letters in the Layer Dialog), the command is disabled.

If the active layer is not the background layer, transparency is replaced with the background color of the Toolbox.

16.7.34.1 Activate the Command

- You can access this command from the image menubar through Layer → Transparency → Remove Alpha Channel.
- In addition, at the [Layer Dialog](#), you can access it through Remove Alpha Channel of its context pop-up menu.

16.7.35 Color to Alpha

This command is the same as Layer → Transparency: Section [16.8.55](#).

16.7.36 Semi-flatten

The Semi-Flatten command is described in the [Semi-flatten](#) filter chapter. The command is useful when you need an anti-aliased image with indexed colors and transparency.

16.7.36.1 Activate the Command

- You can access this command from the image menubar through Layer → Transparency → Semi-Flatten....

16.7.37 Threshold Alpha

The Threshold Alpha command converts semi-transparent areas of the active layer into completely transparent or completely opaque areas, based on a threshold you set, between 0 and 255. It only works on layers of RGB images which have an alpha channel. If the image is Grayscale or Indexed, or if the layer does not have an alpha channel, the menu entry is insensitive and grayed out. If the Keep transparency option is checked in the Layers dialog, the command displays an error message.

16.7.37.1 Activating the Command

- You can access this command from the image menubar through Layer → Transparency → Threshold Alpha.

16.7.37.2 Description of the Dialog Window

Figure 16.120 The only one option of the "Threshold Alpha" dialog

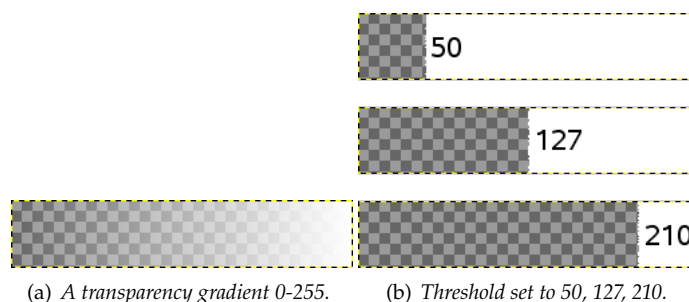


Threshold You can set the transparency value to be used as a threshold by using the slider or by entering a value between 0 and 255 in the input box. All transparency values above this threshold will become opaque and all transparency values below or equal to this threshold will become completely transparent. The transition is abrupt.

Note



This command will never make completely transparent pixels (alpha value = 0) opaque.

Figure 16.121 Threshold Alpha example

16.7.38 Alpha to Selection

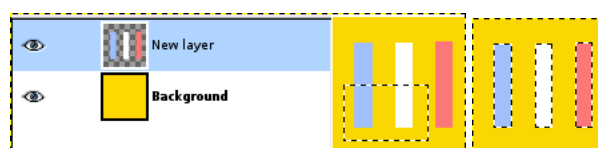
The Alpha to Selection command creates a selection in the current layer from the alpha channel, which encodes transparency. Opaque areas are fully selected, transparent areas are unselected, and translucent areas are partially selected. This selection *replaces* the existing selection. The alpha channel itself is not changed.

The other commands in this group of operations are similar, except that instead of completely replacing the existing selection with the selection produced from the alpha channel, they either add the two selections, subtract the alpha selection from the existing selection, or create a selection that is the intersection of the two.

16.7.38.1 Activate the Command

- You can access this command from the image menubar through Layer → Transparency → Alpha to Selection
- or from the pop-up menu which appears when you right-click on the active layer in the Layer Dialog.

16.7.38.2 Example

Figure 16.122 Applying "Alpha to Selection"

(b) Non-transparent pixels of the active layer have replaced the existing rectangular selection.

16.7.39 Add Alpha channel to Selection

The Add to Selection command creates a selection in the current layer from the Alpha Channel. Opaque pixels are fully selected, transparent pixels are unselected, and translucent pixels are partially selected. This selection is *added* to the existing selection. The alpha channel itself is not changed.

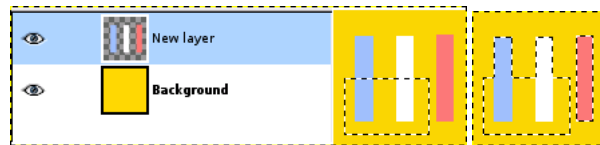
The other commands in this group of operations are similar, except that instead of adding to the existing selection with the selection produced from the active layer, they either completely replace the selection with a selection produced from the alpha selection, subtract the alpha selection from the existing selection, or create a selection that is the intersection of the two.

16.7.39.1 Activate the Command

- You can access this command from the image menubar through Layer → Transparency → Add to Selection.

16.7.39.2 Example

Figure 16.123 Applying "Add to Selection"



(b) Non-transparent pixels of the active layer have been added to the existing selection.

16.7.40 Subtract from Selection

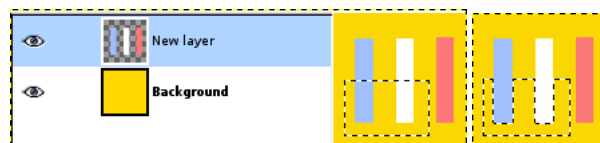
The Subtract from Selection command creates a selection in the current layer from the Alpha Channel. Opaque pixels are fully selected, transparent pixels are unselected, and translucent pixels are partially selected. This selection is *subtracted* from the existing selection. The Alpha channel itself is not changed.

16.7.40.1 Activate the Command

- You can access this command from the image menubar through Layer → Transparency → Subtract from Selection.

16.7.40.2 Example

Figure 16.124 Applying "Subtract from Selection"



(b) Non-transparent pixels of the active layer have been subtracted from the existing rectangular selection.

16.7.41 Intersect Alpha channel with Selection

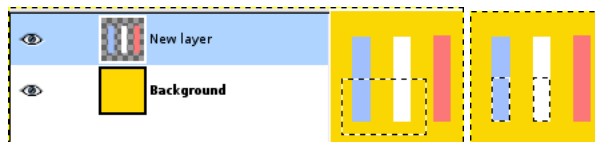
The Intersect with Selection command creates a selection in the current layer from the Alpha Channel. Opaque pixels are fully selected, transparent pixels are unselected, and translucent pixels are partially selected. This selection is *intersected* with the existing selection: only common parts of both selections are kept. The alpha channel itself is not changed.

16.7.41.1 Activate the Command

- You can access this command from the image menubar through Layer → Transparency → Intersect with Selection,
- or from the pop-up menu which appears when you right-click on the active layer in the Layers Dialog.

16.7.41.2 Example

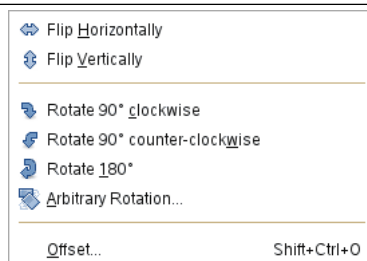
Figure 16.125 Applying "Intersect with Selection"



(b) Non-transparent pixels of the active layer have been intersected with the existing rectangular selection.

16.7.42 The "Transform" Submenu

Figure 16.126 The "Transform" Submenu of the "Layer" menu



The Transform submenu of the Layer menu contains commands which flip or rotate the active layer of the image.

16.7.42.1 Activating the Submenu

- You can access this submenu from the image menubar through Layer → Transform.

16.7.42.2 The Contents of the "Transform" Submenu

The Transform submenu contains the following commands:

- Section [16.7.43](#)
- Section [16.7.44](#)
- Section [16.7.45](#)
- Section [16.7.46](#)
- Section [16.7.47](#)
- Section [16.7.48](#)
- Section [16.7.49](#)

16.7.43 Flip Horizontally

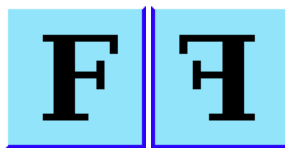
The Flip Horizontally command reverses the active layer horizontally, that is, from left to right. It leaves the dimensions of the layer and the pixel information unchanged.

16.7.43.1 Activating the Command

- You can access this command from the image menubar through Layer → Transform → Flip Horizontally.

16.7.43.2 Example

Figure 16.127 Applying “Flip Layer Horizontally”



(a) Before applying the command (b) The layer after it has been flipped. It looks as if the image has been reflected along the central vertical axis of the layer.

16.7.44 Flip Vertically

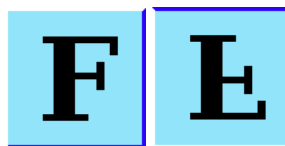
The Flip Vertically command reverses the active layer vertically, that is, from top to bottom. It leaves the dimensions of the layer and the pixel information unchanged.

16.7.44.1 Activating the Command

- You can access this command from the image menubar through Layer → Transform → Flip Vertically.

16.7.44.2 Example

Figure 16.128 Applying “Flip Layer Vertically”



(a) Before applying the command (b) The layer after it has been flipped. It looks as if the image has been reflected along the central horizontal axis of the layer.

16.7.45 Rotate 90° clockwise

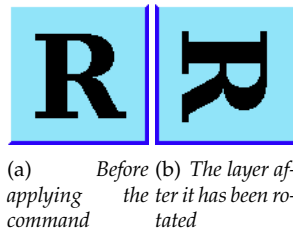
The Rotate 90° clockwise command rotates the active layer by 90° around the center of the layer, with no loss of pixel data. The shape of the layer is not altered, but the rotation may cause the layer to extend beyond the bounds of the image. This is allowed in GIMP and it does not mean that the layer is cropped. However, you will not be able to see the parts which extend beyond the boundary of the image unless you resize the image canvas or move the layer.

16.7.45.1 Activating the Command

- You can access this command from the image menubar through Layer → Transform → Rotate 90° clockwise.

16.7.45.2 Example

Figure 16.129 Applying "Rotate 90° clockwise"



16.7.46 Rotate 90° counter-clockwise

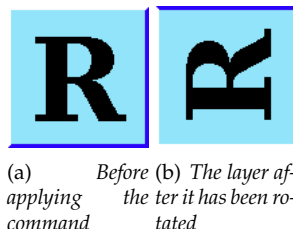
The Rotate 90° counter-clockwise command rotates the active layer by 90° counter-clockwise around the center of the layer, with no loss of pixel data. The shape of the layer is not altered, but the rotation may cause the layer to extend beyond the bounds of the image. This is allowed in GIMP and it does not mean that the layer is cropped. However, you will not be able to see the parts which extend beyond the boundary of the image unless you resize the image canvas or move the layer.

16.7.46.1 Activating the Command

- You can access this command from the image menubar through Layer → Transform → Rotate 90° counter-clockwise.

16.7.46.2 Example

Figure 16.130 Applying "Rotate 90° counter-clockwise"



16.7.47 Rotate 180°

The Rotate 180° command rotates the active layer by 180° around the center of the layer, with no loss of pixel data. The shape of the layer is not altered. Since the layers have a rectangular shape, a 180° rotation only inverts them and they can't extend beyond the image limits.

16.7.47.1 Activating the Command

- You can access this command from the image menubar through Layer → Transform → Rotate 180°.

16.7.47.2 Example

Figure 16.131 Applying “Rotate 180°”



(a) Before applying the command
(b) The layer after it has been rotated. It is turned upside down.

16.7.48 Arbitrary Rotation

The Arbitrary Rotation command rotates a layer by a specified angle. It is an alternate way of accessing the **Rotate** tool. See the section about that tool for more information.

16.7.48.1 Activating the Command

- You can access this command from the image menubar through Layer → Transform → Arbitrary Rotation,
- or by using the keyboard shortcut Shift-R.

16.7.48.2 Example

Figure 16.132 Applying “Rotate Arbitrary”



(a) Before applying the command
(b) The layer after it has been rotated 30° clockwise

16.7.49 Offset

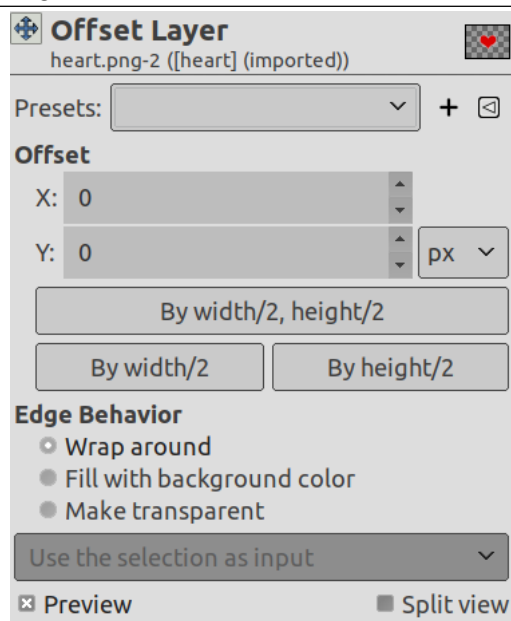
The Offset command shifts the *content* of the active layer. Anything shifted outside the layer boundary is cropped. This command displays a dialog which allows you to specify how much to shift the layer and how to fill the space that is left empty by shifting it. It can be used to create tileable patterns.

16.7.49.1 Activating the Command

- You can access this command from the image menubar through Layer → Transform → Offset,
- or by using the keyboard shortcut Shift-Ctrl-O.

16.7.49.2 “Offset” Options

Figure 16.133 The “Offset” dialog



Presets, Preview, Split view These options are common to GEGL-based dialogs. Please refer to Section 17.2.

Offset

X; Y With these two values, you specify how far the contents of the layer should be shifted in the horizontal (X) and vertical (Y) directions. You can enter the offsets in the text boxes. Positive values move the layer to the right and downward. The default unit is pixels, but you can choose a different unit of measurement with the drop-down menu. A unit of “%” is sometimes useful. Since GIMP-2.10.12, you can click-and-drag on canvas to move the layer.

Offset by x/2, y/2 With this button, you can automatically set the X and Y offsets so that the contents are shifted by exactly half the width and half the height of the image.

Edge Behavior You can specify one of three ways to treat the areas left empty when the contents of the layer are shifted:

- *Wrap around*: The empty space on one side of the layer is filled with the part of the layer which is shifted out of the other side, so none of the content is lost.
- *Fill with background color*: The empty space is filled with the background color, which is shown in the Color Area of the Toolbox.
- *Make transparent*: The empty space is made transparent. If the layer does not have an alpha channel, this choice is not available (grayed out).

16.7.49.3 Examples

Figure 16.134 Using “Offset” together with “Edge Behaviors”

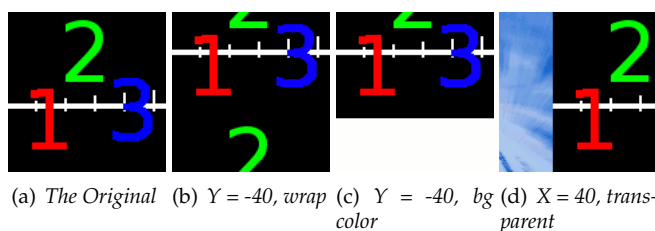
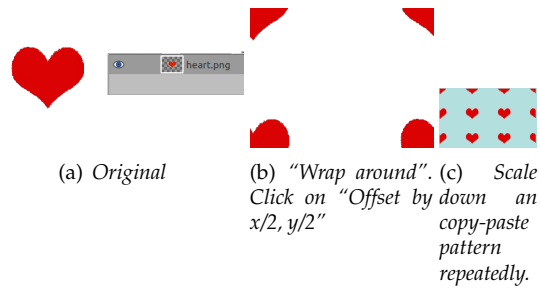


Figure 16.135 Repeatable pattern

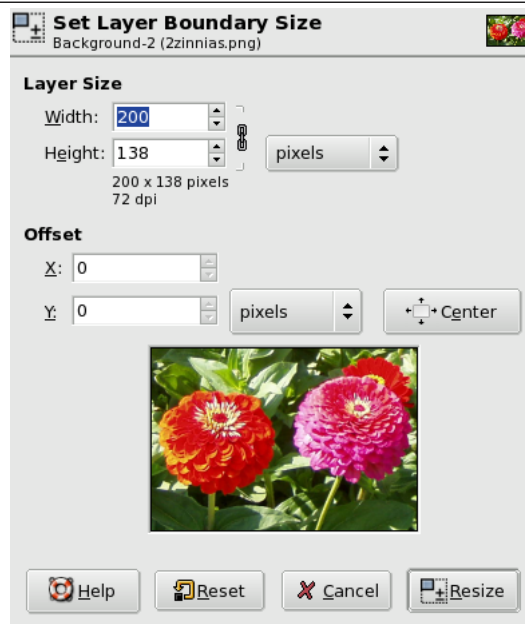
16.7.50 Layer Boundary Size

In GIMP, a layer is not always the same size as the others. This command changes the dimensions of a layer, but it does not **scale** its contents.

16.7.50.1 Activating the Command

You can access this command from the image menubar through Layer → Layer Boundary Size.

16.7.50.2 Description of the "Layer Boundary Size" dialog

Figure 16.136 The "Layer Boundary Size" Dialog

Layer Size

Width; Height When the dialog is displayed, the original dimensions of the active layer are shown. You can change them by using the two text boxes. If these boxes are linked together with a chain, the width-to-height ratio is automatically maintained. If you break the chain by clicking on it, you can set the dimensions independently of each other.

The default unit of measurement is pixels. You can change this by using the drop-down menu. For instance, you might use a "%" of the current size.

X Offset; Y Offset These coordinates are relative to the layer, not to the image. They are used to move a frame that determines which part of the layer content will be selected for the resized layer. In our example, the layer and the content have the same dimensions, and, of course, you have no frame to move. If you reduce Width and Height, the frame of the resized layer appears in the preview.

Below the coordinates, a preview represents the layer with the frame of the resized layer. You can move this frame using the X and Y offsets and also dragging the cross-shaped moving pointer that appears when the mouse pointer overflies the layer area.

The Center button This button allows you to place the frame at the center of the layer.

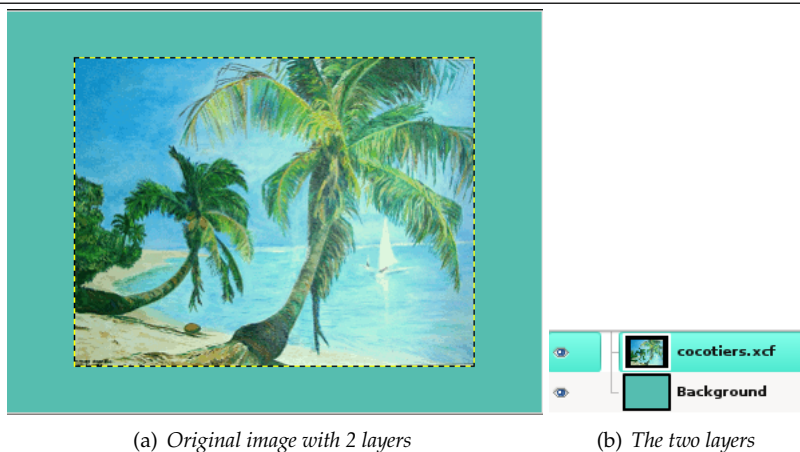
16.7.50.3 Resizing Layer

Resizing a layer larger You can't resize a layer to bigger dimensions than that of the image.

If the layer is smaller than the image, you can enlarge Width and/or Height . There is no good reason to do that, except if you want to enlarge the layer to the size of the image; but, in that case, it's better to use **Layer to Image Size**.

Resizing a layer smaller You can resize the layer to a smaller dimension to eliminate unwanted parts.

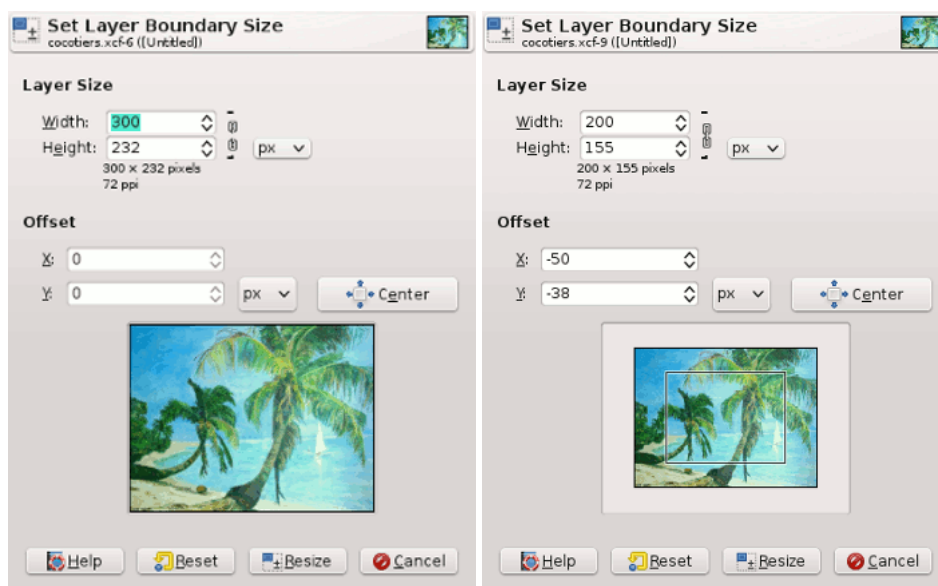
Figure 16.137 Example



(a) Original image with 2 layers

(b) The two layers

Figure 16.138 Example



(a) The selected layer for resizing

(b) The frame representing the new layer size. It has been placed at the center of the layer using the Center button.

Figure 16.139 Result

If the image has only one layer, it's better to use the **Crop tool**.

16.7.51 Layer to Image Size

The Layer to Image Size command resizes the layer boundaries to match the image boundaries, without moving the contents of the layer with respect to the image.

16.7.51.1 Activating the Command

- You can access this command from the image menubar through Layer → Layer to Image Size.

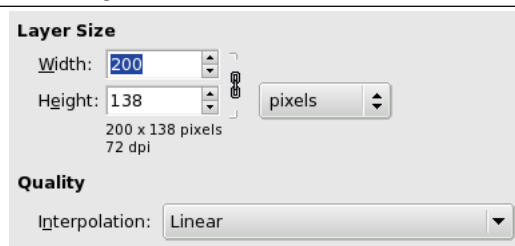
16.7.52 Scale Layer

The Scale Layer command opens the “Scale Layer” dialog that allows you to resize the layer and its contents. The image loses some of its quality by being scaled. The command displays a dialog where you can set parameters concerning the size of the layer and the image quality.

16.7.52.1 Activating the Command

You can access this command from the image menubar through Layer → Scale Layer....

16.7.52.2 Description of the “Scale Layer” Dialog

Figure 16.140 The “Scale Layer” dialog

Layer Size When you enlarge a layer, GIMP has to calculate new pixels from the existing ones. This procedure is called “interpolation”. Please note that no matter which interpolation algorithm is used, no new information is added to the image by interpolation. If there are places in the layer which have no details, you will not get any new ones by scaling it. It is much more likely that the layer will look somewhat blurred after scaling. Similarly, when you reduce a layer, the image loses some of its quality when pixels are removed.

Width; Height The command displays a dialog which shows the dimensions of the original layer in pixels. You can set the new Width and Height for the layer in the two text boxes. If the adjacent chain icon is unbroken, the width and height are automatically adjusted to hold their ratio constant. If you break the chain by clicking on it, you can set them separately, but this will result in distorting the layer.

However, you do not have to set the dimensions in pixels. You can choose different units from the drop-down menu. If you choose percent as units, you can set the layer size relative to its original size. You can also use physical units, like inches or millimeters. However if you do that, you should pay attention to the X/Y resolution of the image.

If you enlarge a layer, the missing pixels are calculated by interpolation, but no new details are added. The more the layer is enlarged, and the more times it is enlarged, the more blurred it becomes. The exact result of the enlargement depends upon the interpolation method you choose. After scaling, you can improve the result by using the **Sharpen (Unsharp Mask)** filter, but it is much better for you to use a high resolution when scanning, taking digital photographs or producing digital images by other means. It is an inherent characteristic of raster images that they do not scale up well.

Quality To change the size of the layer, GIMP either has to add or remove pixels. The method it uses to do this has a considerable impact on the quality of the result. You can choose the method of interpolating the colors of the pixels from the Interpolation drop-down menu.

Interpolation

None No interpolation is used. Pixels are simply enlarged or removed, as they are when zooming. This method is low in quality, but very fast.

Linear This method is a good compromise between speed and quality.

Cubic This method takes a lot of time, but it produces the best results.

Sinc (Lanczos3) The Lanczos (pronounce “lanzosh”) method uses the Sinc³ mathematical function to perform a high quality interpolation.

16.7.53 Crop Layer

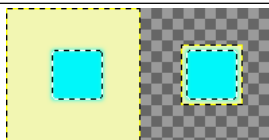
You can crop layer in two ways:

- Crop to selection
- Crop to content

16.7.53.1 Crop to selection

The Crop to Selection command crops only the active layer to the boundary of the selection by removing any strips at the edge whose contents are all completely unselected. Areas which are partially selected (for example, by feathering) are not cropped. If there is no selection for the image, the menu entry is insensitive and grayed out.

Figure 16.141 Applying “Crop to Selection”



On the left: before applying the command, the layer has a selection that has feathered edges.

On the right: after applying the command, the non-transparent pixels are not cropped, even if they are only semi-transparent.

16.7.53.2 Crop to content

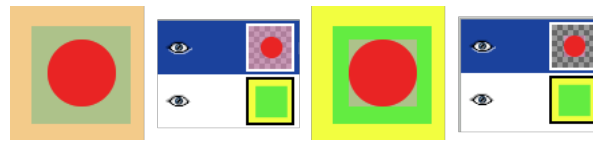
The Crop to content command automatically crops the active layer, unlike the **Crop Tool**, or the **Crop to Selection** command which let you manually define the area to be cropped.

This command removes the largest possible area around the outside edge which all has the same color. It does this by scanning the layer along a horizontal line and a vertical line and cropping the layer as soon as it encounters a different color, whatever its transparency.

You can use this command to crop the layer to the dimensions of a subject that is lost in a solid background which is too large.

³Sinus cardinalis

Figure 16.142 “Crop to content” example



(a) Before applying “Crop to content”
 (b) After applying “Crop to content”: the active layer, up, has been cropped to the size of the circle it contains. Its size is reduced, and the unoccupied part in the canvas is transparent, revealing the yellow and green colors of the underlying layer.

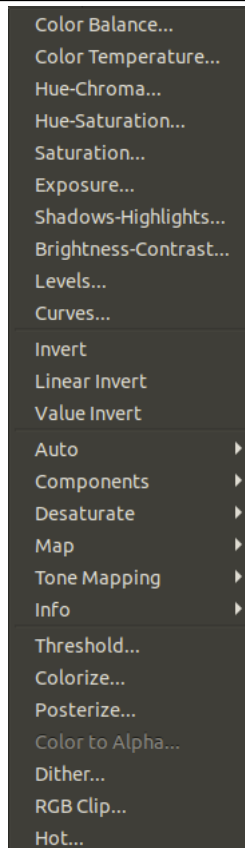
16.7.53.3 Activating the Command

- You can access this command from the image menubar through Layer → Crop to Selection.

16.8 The “Colors” Menu

16.8.1 Introduction to the “Colors” Menu

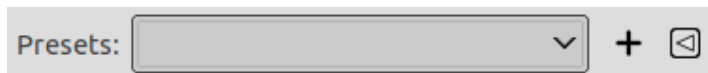
Figure 16.143 Contents of the “Colors” Menu



This section describes the Colors menu, which contains commands that affect the color of the image.

Note

Besides the commands described here, you may also find other entries in the menu. They are not part of GIMP itself, but have been added by extensions (plug-ins). You can find information about the functionality of a Plugin by referring to its documentation.

16.8.1.1 Colors Common Features**Presets**


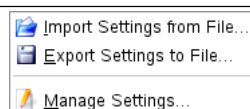
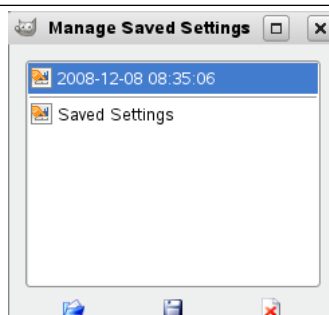
The  button opens a menu:

Figure 16.144 Preset Menu

which lets you Import Settings from File or Export Settings to File, and gives you access to the Manage Save Settings dialog:

Figure 16.145 Manage saved Settings Dialog**Preview and Split view**

- **Preview:** this option is checked by default and displays changes directly on canvas.
- **Split view:** if this option is checked, the image window is divided in two parts. Changes appear in the left part and the right part remains unchanged for comparison.

16.8.2 Color Balance

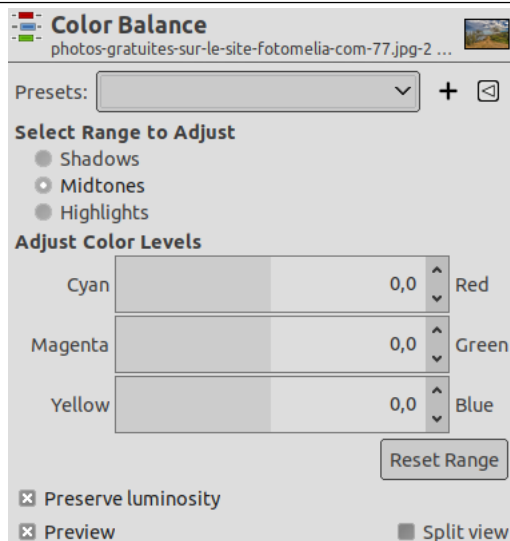
The color balance tool modifies the color balance of the active selection or layer. Changes are not drastic. This tool is suitable to correct predominant colors in digital photos.

16.8.2.1 Activating the Tool

You can get to the Color balance through: Colors → Color Balance...

16.8.2.2 Options

Figure 16.146 Color Balance options



Presets “Presets” are a common feature for several Colors command. You can find its description in Section [16.8.1](#).

Select range to adjust Selecting one of these options restricts the range of colors which are changed with the sliders or input boxes for Shadows (darkest pixels), Midtones (medium pixels) and Highlights (brightest pixels).

Adjust color levels Sliders and range from the three RGB colors to their complementary colors (CMY). The zero position corresponds to the current level value of pixels in the original image. You can change the pixel color either towards Red or Cyan, Green or Magenta, Blue or Yellow.

Reset Range This button sets color levels of the selected range back to the zero position (original values).

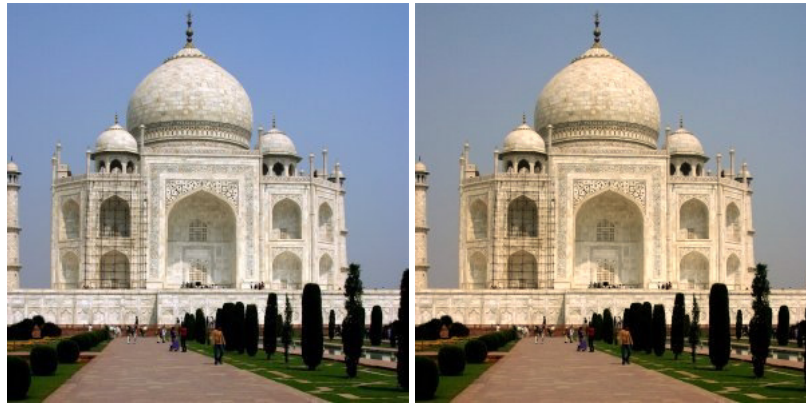
Preserve Luminosity This option ensures that brightness of the active layer or selection is maintained. The Value of brightest pixels is not changed.

Preview and Split view These are common features described in Section [16.8.1](#).

16.8.3 Color Temperature

16.8.3.1 Overview

Figure 16.147 Example for the “Color Temperature” filter



(a) Original image, with color temperature estimated at 5,000K (b) Modified image, with color temperature changed to 6,500K

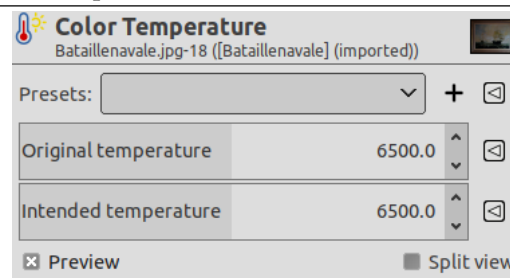
The Color Temperature filter allows adjusting color temperature of the light source in an image in Kelvin. It can be used to correct the bluish cast in overcast photos, or even (to some extent) the red cast in photos taken under incandescent light with the camera set to daylight.

16.8.3.2 Activate the filter

You can find this command through Colors → Color Temperature....

16.8.3.3 Options

Figure 16.148 “Color Temperature” options



Original temperature This is the estimated original color temperature of the light source in Kelvin. You can change it because the image doesn’t necessarily encode that information correctly or at all (and you might or might not have measured it). In addition there’s often a mix of light sources (a window, a fill-in flash, a pile of burning organic fair-trade bamboo wood harvested under a full moon)... But above all else you can get interesting creative effects by changing it

Intended temperature This is the desired color temperature of the light source in Kelvin.

Both original temperature and intended temperature can be set via presets. To access presets menu, click a button with a triangle icon to the right from either of the two options.

16.8.4 Hue Chroma

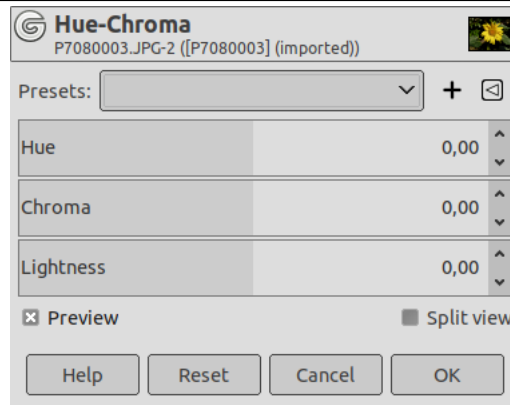
The Hue-Chroma filter is another way to modify saturation. Clear explanations about chroma and saturation can be found at <https://ninedegreesbelow.com/photography/changing-saturation-using-lch.html>.

16.8.4.1 Activating the Command

You can get to the Hue-Chroma dialog through: Colors → Hue-Chroma...

16.8.4.2 Options

Figure 16.149 Hue-Chroma Options



Presets “Presets” are a common feature for several Colors command. You can find its description in Section [16.8.1](#).

Hue The slider and the small arrow buttons allow you to select a hue in the color circle (-180° , 180°).

Chroma “Chroma” is the purity of the color. Moving this slider makes colors more or less pure.

Lightness This slider and the small arrow buttons allow you to select a value (luminosity): -100 , 100 .

Preview and Split view These are common features described in Section [16.8.1](#).

16.8.5 Hue-Saturation

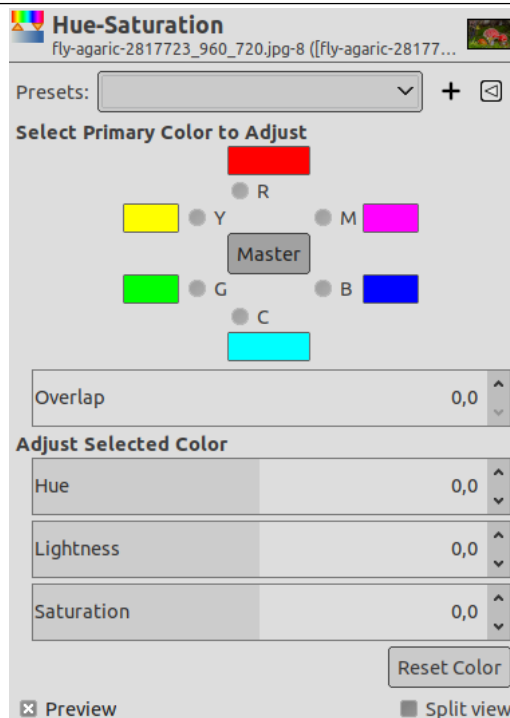
The Hue-Saturation command is used to adjust hue, saturation and lightness levels on a range of color weights for the selected area or active layer.

16.8.5.1 Activating the command

You can get to the Hue-Saturation command through: Colors → Hue-Saturation...

16.8.5.2 Options

Figure 16.150 Hue-Saturation Options



Presets “Presets” are a common feature for several Colors command. You can find its description in Section 16.8.1.

Select Primary Color to Adjust You can choose to adjust any of six colors: the three primary colors (Red, Green and Blue) and the three complementary colors (Cyan, Magenta and Yellow). They are arranged according to the color circle. When hue increases, hue goes counter-clockwise. When it decreases, it goes clockwise. If you click the Master button, changes you make affect all colors. GIMP default is to set Red as 0. Note that this colors refer to color ranges and not to color channels.

Hue changes are shown in color swatches and the result is visible in the image if the Preview option is enabled.

Overlap This slider lets you set how much color ranges overlap. This effect is very subtle and works on closely-related colors only:

Figure 16.151 Example for the Overlap option



(a) Original image. (b) Overlap = 0. (c) Overlap = 100.
 From the left to the Hue = 15. Colors Hue = 15. Colors right:
 a reddish become (186;255;1), become (192;255;1),
 yellow (255;240;0); (168;255;1), (168;255;1),
 a pure yellow (156;255;1). (162;255;1). Be-
 cause of overlap, greenish is less
 green and reddish is less red.
 (255;255;0); a
 greenish yellow
 (240;255;0).

Adjust Selected Color

- Hue: The slider and the input box allow you to select a hue in the color circle (-180, 180).

- **Lightness:** The slider and the input box allow you to select a value (luminosity): -100, 100.

Note



Lightness changes here concern a color range, while they concern a color tone with Curves and Levels tools, which work on color channels. If you change the Yellow lightness with Hue-Saturation, all yellow pixels will be changed, while only dark, bright or medium pixels luminosity will be changed with Curves or Levels tools.

- **Saturation:** The slider and the input box allow you to select a saturation: -100, 100.

The Initialize Color button deletes changes to hue, lightness and saturation of the selected color.

Preview and Split view These are common features described in Section 16.8.1.

16.8.6 Saturation

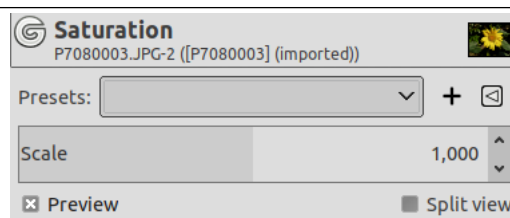
Another way to modify saturation. Clear explanations about chroma and saturation can be found at <https://ninedegreesbelow.com/photography/changing-saturation-using-lch-chroma.html>

16.8.6.1 Activating the Command

You can get to the Saturation dialog through: Colors → Saturation...

16.8.6.2 Options

Figure 16.152 Saturation Options



Presets "Presets" are a common feature for several Colors command. You can find its description in Section 16.8.1.

Scale This option gives more or less saturation.

Preview and Split view These are common features described in Section 16.8.1.

16.8.7 Exposure

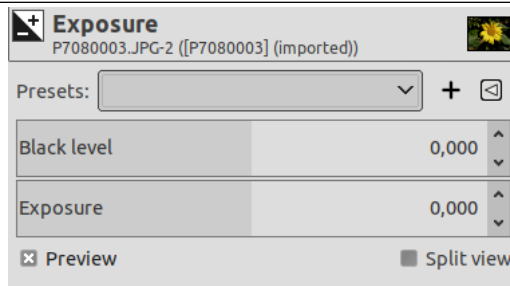
This filter is used for lightning shadows and midtones of an image without blowing the highlights. A detailed tutorial can be found at Appendix X.

16.8.7.1 Activating the Command

You can get to the Exposure dialog through: Colors → Exposure...

16.8.7.2 Options

Figure 16.153 Exposure Options



Presets “Presets” are a common feature for several Colors command. You can find its description in Section 16.8.1.

Black level This option is used to dispense with “useless” shadows and highlight information.

Exposure This option is used to add one or more stops of exposure compensation to the image.

Preview and Split view These are common features described in Section 16.8.1.

16.8.8 Shadows-Highlights

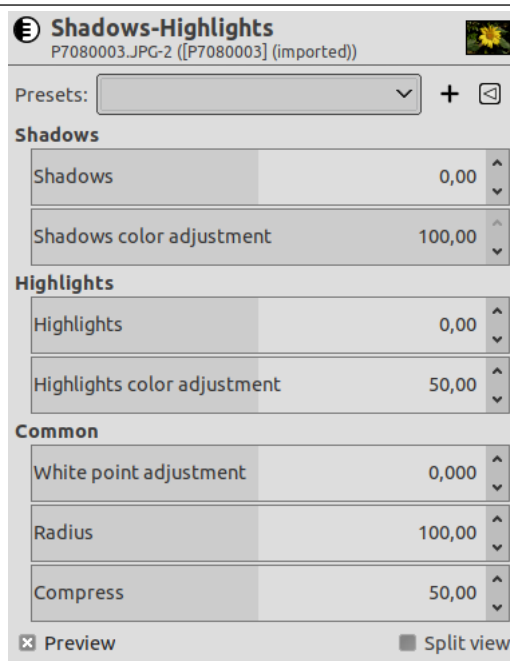
This filter allows adjusting shadows and highlights in the image separately. The implementation closely follow its counterpart in the Darktable photography software [Shadows and Highlights](#).

16.8.8.1 Activating the Command

You can get to the Shadows-Highlights dialog through: Colors → Shadows-Highlights...

16.8.8.2 Options

Figure 16.154 Shadows-Highlights Options



Presets “Presets” are a common feature for several Colors command. You can find its description in Section 16.8.1.

Three options groups: Shadows: options for shadows:

- **Shadows:** This slider controls the effect on shadows; positive values lighten shadows while negative values darken them.
- **Shadows color adjustment:** This slider controls the color saturation adjustment made to shadows; high values cause saturation enhancements on lightened shadows; low values cause desaturation on lightened shadows. It is normally safe to leave this at its default of 100%. This gives a natural saturation boost on shadows—similar to the one you would also expect in nature if shadows received more light.

Highlights: options for highlights:

- **Highlights:** This slider controls the effect on highlights; negative values darken highlights while positive values lighten them.
- **Highlights color adjustment:** This slider controls the color saturation adjustment made to highlights; high values cause saturation enhancements on darkened highlights; low values cause desaturation on darkened highlights. Often highlights do not contain enough color information to give convincing colors when darkened. You might need to play a bit with this parameter in order to find the best fitting value depending on your specific image; but be aware that sometimes results still might not be fully satisfying.

Common: options common to shadows and highlights:

- **White point adjustment:** By default the algorithm of this module leaves black point and white point untouched. In some cases an image might contain tonal variations beyond the white point, i.e. above a luminance value of 100. A negative shift in the white point adjustment slider allows to bring these values down into the proper range so that further details in the highlights get visible.
- **Radius:** This slider controls the radius of the involved blurring filter. Higher values give softer transitions between shadows and highlights but might introduce halos. Lower values reduce the size of halos but may lead to an artificial look.
- **Compress:** This slider controls how strong the effect extends to mid-tones; high values reduce the effect to the extreme shadows and highlights; low values cause strong adjustments also to mid-tones. You normally only need to touch this parameter if you want to limit the effects to the extreme shadows and highlights; increase the value in this case. At 100% this module has no visible effect any longer as only absolute black and absolute white are affected.

Preview and Split view These are common features described in Section 16.8.1.

16.8.9 Brightness-Contrast

The Brightness-Contrast tool adjusts the brightness and contrast levels for the active layer or selection. This tool is easy to use, but relatively unsophisticated. The Levels and Curve tools allow you to make the same types of adjustments, but also give you the ability to treat bright colors differently from darker colors. Generally speaking, the Brightness-Contrast tool is great for doing a “quick and dirty” adjustment in a few seconds, but if the image is important and you want it to look as good as possible, you will want to use one of the other tools.


In GIMP 2.4 and newer, a new way of operating this tool is available: by clicking the mouse inside the image, and dragging while keeping the left mouse button down. Moving the mouse vertically changes the brightness; moving horizontally changes the contrast. When you are satisfied with the result, you can either press the OK button on the dialog, or press the **Return** key on your keyboard.

Note

With GIMP 2.10 and newer, the Brightness-Contrast tool works on indexed layers.

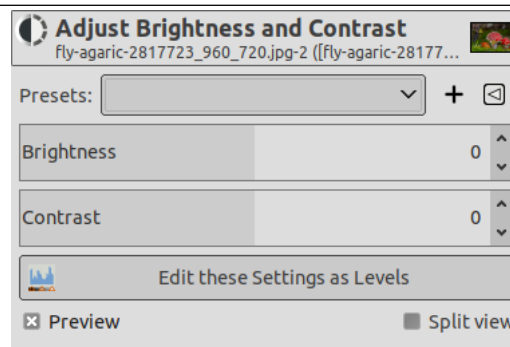
16.8.9.1 Activating the Tool

You can get to this tool in two ways:

- In the image menubar through Colors → Brightness-Contrast...
- By clicking the tool icon  in the toolbox if this tool has been installed there. For this, please refer to Section 12.1.11.

16.8.9.2 Options

Figure 16.155 Brightness-Contrast options dialog



Presets “Presets” are a common feature for several Colors command. You can find its description in Section 16.8.1.

Brightness This slider sets a negative (to darken) or positive (to brighten) value for the brightness, decreasing or increasing bright tones.

Contrast This slider sets a negative (to decrease) or positive (to increase) value for the contrast.

Edit these settings as Levels To make your work easier, this button lets you turn to the **Levels** tool with the same settings.

Preview and Split view These are common features described in Section 16.8.1.


16.8.10 Levels

The Level tool provides features similar to the **Histogram** dialog but can also change the intensity range of the active layer or selection in every channel. This tool is used to make an image lighter or darker, to change contrast or to correct a predominant color cast.

16.8.10.1 Activating the Tool

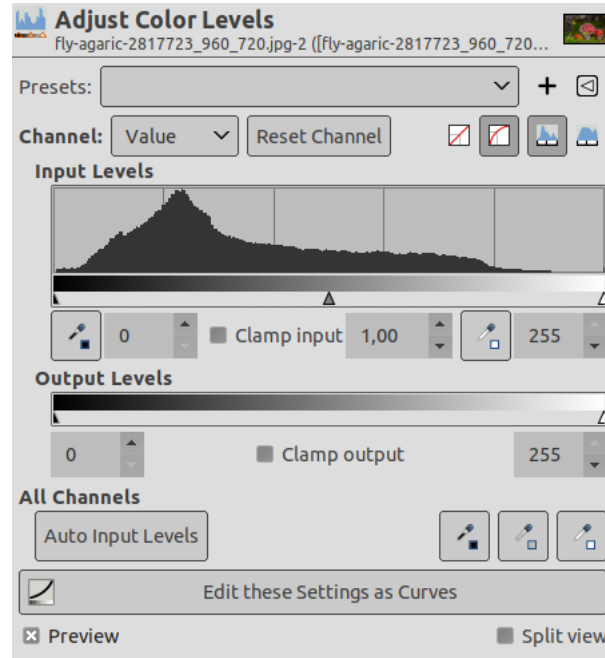
You can get to this tools in two ways:

- In the image menu through Colors → Levels....

- By clicking on the tool icon  in the toolbox if this tool has been installed there. For this, please refer to Section 12.1.11.

16.8.10.2 Options

Figure 16.156 Level tool options



Presets “Presets” are a common feature for several Colors command. You can find its description in Section 16.8.1.

Channel You can select the specific channel which will be modified by the tool:

- Value makes changes to the value of all RGB channels in the image: the image becomes darker or lighter.
- Red, Green and Blue work on a particular color channel: the image gets more or less color. Remember that adding or removing a color results in removing or adding the complementary color.
- Alpha works on semi-transparent layers or selections: here, dark means more transparency, and white is fully opaque. Your image must have an Alpha Channel, otherwise this option is disabled.
- Reset channel restores the original setting for the selected channel.

Four buttons available with GIMP 2.10 and newer With the two left buttons, you can switch between linear and perceptual (non-linear) modes, depending on which you need.

With the two right buttons, you can switch between Linear and Logarithmic histogram.

Input Levels The main area is a graphic representation of the active layer or selection dark (Shadows), mid and light (Highlight) tones content (the Histogram). They are on the abscissa from level 0 (black) to level 255 (white). Pixel number for a level is on the ordinate axis. The curve surface represents all the pixels of the image for the selected channel. A well balanced image is an image with levels (tones) distributed all over the whole range. An image with a blue predominant color, for example, will produce a histogram shifted to the left in Green and Red channels, signified by green and red lacking on highlights.



Level ranges can be modified in three ways:

- Three triangles as sliders: one black for dark tones (Shadows), one grey for midtones (Gamma), one white for light (Highlights) tones.

The black slider determines the *black point* : all pixels with this value or less will be black (no color with a color channel selected / transparent with the Alpha channel selected).

The white slider determines the *white point* : all pixels with this value or higher, will be white (fully colored with a color channel selected / fully opaque with the Alpha channel selected).

The gray slider determines the *mid point*. Going to the left, to the black, makes the image lighter (more colored / more opaque). Going to the right, to the white, makes the image darker (less colored / more transparent).

- Two eye-droppers: when you click them, the mouse pointer becomes an eye-dropper. Then clicking on the image determines the black or the white point according to the chosen eye-dropper. Use the left, dark one  to determine the black-point; use the right, white one  to determine the white point.
- Three numeric text boxes to enter values directly.

Input Levels are used to lighten highlights (bright tones), darken shadows (dark tones), change the balance of bright and dark tones. Move sliders to the left to increase lightness (increase the chosen color / increase opacity). Move the sliders to the right to lessen lightness (lessen the chosen color / lessen opacity).

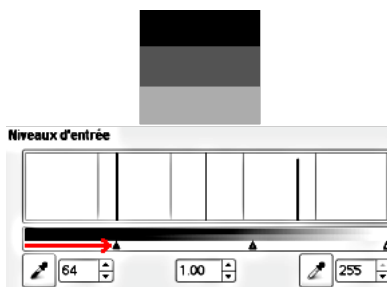
Examples for Input Levels

The original image is a gray-scaled image with three stripes: Shadows (64), Mid Tones (127), Highlights (192). The histogram shows three peaks, one for each of the three tones.



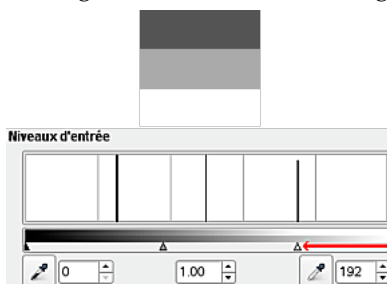
Original image

1. The Value channel is selected. The black slider (Shadows) has been moved up to the Shadows peak. The 64 value became 0 and the Shadows stripe became black (0). The Gamma (mid tones) slider is automatically moved to the middle of the tone range. Mid tones are made darker to 84 and Highlights to 171.



Black slider has been moved

2. The white slider (highlights) has been moved up to the highlight peak. The 192 value became 255 and the highlight stripe became white. The Gamma (mid tones) slider is automatically moved to the middle of the tone range. Mid tones are made lighter to 169 and Shadows to 84.



White slider has been moved

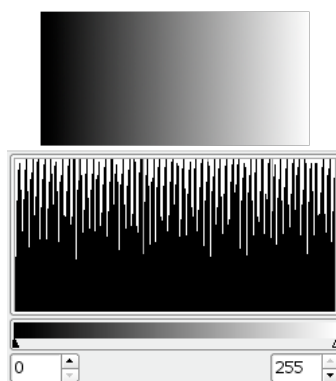
Output Levels Output levels allow manual selection of a constrained output level range. There are also numeric text boxes with arrowheads located here that can be used to interactively change the Output Levels.

Output levels force the tone range to fit the new limits you have set.

- Working with Value: values are compressed and look more alike; so contrast is reduced. Shadows are made lighter: new details can show up but contrast is less; a compromise is necessary. Highlights are made darker.
- Working with Color channels: if you use the green channel for example and set the output levels between 100 and 140, all pixels with some green, even a low value, will have their green channel value shifted between 100 and 140.
- Working with Alpha channel: all Alpha values are shifted to the range you have set.

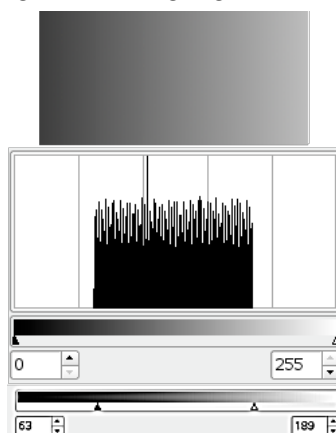
Example for Output Levels

1. The original image is a RGB gradient from black (0;0;0) to white (255;255;255). Output Levels has no histogram; here, we used Windows → Dockable Dialogs → Histogram.



Original image (a gradient)

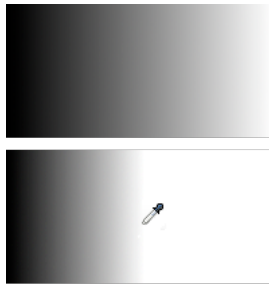
2. Value channel selected. The black slider has been moved to 63 and the white slider to 189. The Histogram shows the compression of pixels. No pixel is less than 63, and no pixel is more than 189. In the image, Shadows are lighter and Highlights are darker: contrast is reduced.



Black slider has been moved

All Channels Auto: Performs an automatic setting of the levels.

Three eyedroppers , , . These three buttons respectively represent a white, a gray and a black eye-dropper. When you click one of these buttons, the mouse pointer takes the form of the eye-dropper it represents. Then, when clicking the image, the clicked pixel determines the *white point*, the *black point* or the *mid point* according to the eye-dropper you chose. Works on all channels, even if a particular channel is selected.

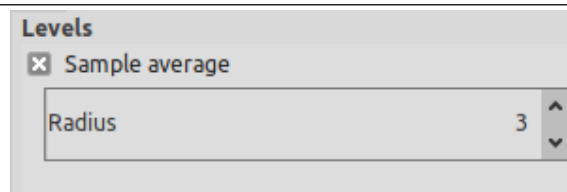
Figure 16.157 Example for Levels eye-droppers

Above is original gradient from black to white. Below is the result after clicking with the white eye-dropper: all pixels with a value higher than that of the clicked pixel turned to white.

Edit these settings as Curves To make your work easier, this button lets you turn to the **Curves** tool with the same settings.

Preview and Split view These are common features described in Section 16.8.1.

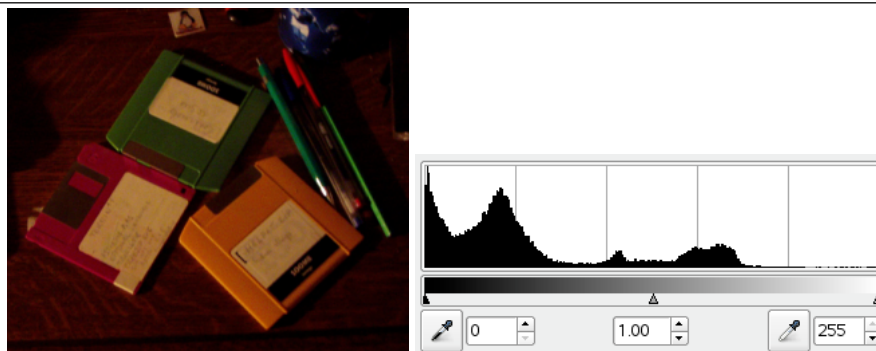
16.8.10.3 Tool Options dialog

Figure 16.158 "Levels" tool options

Although this tool is not present in the Toolbox by default (please refer to Section 12.1.11 if you want to add it), nevertheless it has a Tool Option Dialog under the Toolbox.

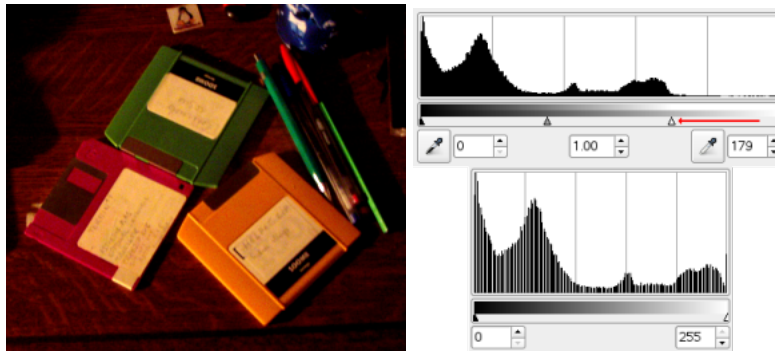
Sample Average This slider sets the "radius" of the color-picking area to get the averaged color value from nearby pixels. This area appears as a more or less enlarged square when you maintain the click on a pixel.

16.8.10.4 Actual practice

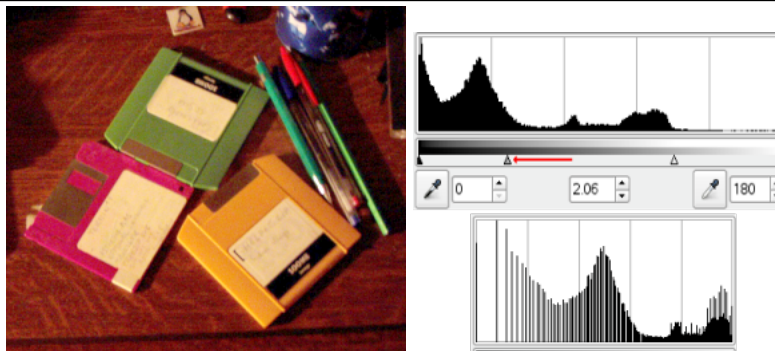
Figure 16.159 A very under-exposed image

(a) Original image

(b) The histogram shows a predominance of Shadows and missing Highlights.

Figure 16.160 Setting the white point

(a) The white slider has been moved to the start (b) The resulting histogram (down) shows of well marked Highlights. The image lightens Highlights now, but Shadows are still pre-dominant.

Figure 16.161 Setting the balance between Shadows and Highlights

(a) The mid slider has been moved to the left. (b) The resulting histogram (down) con- This results in reducing the proportion of Shad- firms the reduction of Shadows. ows and increasing the proportion of High- lights.


16.8.11 Curves

The Curves tool is the most sophisticated tool for changing the color, brightness, contrast or transparency of the active layer or a selection. While the Levels tool allows you to work on Shadows and Highlights, the Curves tool allows you to work on any tonal range. It works on RGB images.

16.8.11.1 Activating the Tool

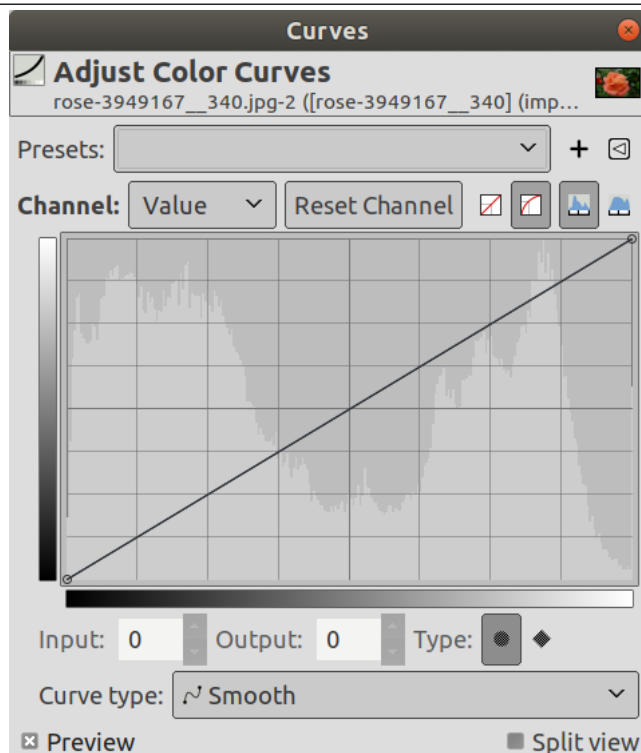
You can get to this tool in two ways:

- In the image menu through Colors → Curves....

- By clicking on the tool icon  in Toolbox, if this tool has been installed there. For this, please refer to Section 12.1.11.

16.8.11.2 "Curves" options

Figure 16.162 The "Curves" dialog



Presets, Preview, Split view These options are common to GEGL-based filters. Please refer to Section 16.8.1.

Channel There are five options:

Value The curve represents the Value, i.e. the brightness of pixels as you can see them in the composite image.

Red; Green; Blue The curve represents the quantity of color in each of the three RGB channels. Here, *dark* means *little* of the color. *Light* means *a lot* of the color.

Alpha The curve represents the opacity of the pixels. *Dark* means *very transparent*. *Light* means *very opaque*. Your image or active layer must have an Alpha channel for this option to be enabled.

Reset Channel This button deletes all changes made to the selected channel and returns to default values.

Adjust curves in linear light and Adjust curves perceptually These buttons appear in GIMP 2.10 and newer. They allow you to switch between linear and perceptual (non-linear) modes.

Linear and Logarithmic buttons These buttons allow to choose the Linear or Logarithmic type of the histogram. You can also use the same options in Tool Options dialog. This grayed out histogram is not displayed by default.

Main Editing Area

- **The horizontal gradient:** it represents the *input* tonal scale. It, too, ranges from 0 (black) to 255 (white), from Shadows to Highlights. When you adjust the curve, it splits into two parts; the upper part then represents the *tonal balance* of the layer or selection.
- **The vertical gradient:** it represents the destination, the *output* tonal scale. It ranges from 0 (black) to 255 (white), from Shadows to Highlights.
- **The chart:** the curve is drawn on a grid and goes from the bottom left corner to the top right corner. The *pointer x/y position* is permanently displayed in the top left part of the grid. By

default, this curve is straight, because every input level corresponds to the same output tone. GIMP automatically places a point at both ends of the curve, for black (0) and white (255).

If you click the curve, a new *point* is created. When the mouse pointer goes over a point, it takes the form of a small hand. You can click-and-drag the point to bend the curve.

If you click outside the curve, a point is also created, and the curve includes it automatically. If you **Ctrl**-click outside the curve, the Y-coordinate snaps to the original curve: this is particularly useful for adding points along the curve.

Inactive points are white. The active point is black. You can activate a point by clicking it. You can also swap the point activation by using the Left and Right arrow keys of your keyboard.

Two points define a *curve segment* which represents a tonal range in the layer. You can click-and-drag this segment (this creates a new point). Of course, you can't drag it beyond the end points.

To *move a point*, there are several possibilities to fine tune the point position:

- Click-and-drag the point.
- Using Up and Down arrow keys (Holding the **Shift** down lets you move it by increments of 15 pixels) to move the point vertically.
- **Ctrl** + click-and-drag allows you to move the point along the curve in its segment, independently of the point position.
- Another way to move point is using the "Input" and "Output" spin buttons, which are available in GIMP 2.10.12 and newer: see below.

To *delete* all points (apart from both ends that can't be deleted), click the Reset Channel button. To delete only one point, move it beyond any adjacent point horizontally.

Meanwhile, on the canvas, the mouse pointer has the form of an eye-dropper. If you click a pixel, a vertical line appears on the chart, positioned to the source value of this pixel in the selected channel. If you **Shift**-click, you create a point in the selected channel. If you **Ctrl**-click, you create a point in all channels, possibly including the Alpha channel. You can also **Shift**-drag and **Ctrl**-drag: this moves the vertical line and the point appears when releasing the mouse left button.

The *histogram* of the active layer or selection for the selected channel is represented in gray in the chart. It's only a reference and is not updated during treatment.

Input, Output These spin buttons allow setting the selected point coordinates numerically and accurately if needed.

Type Control points can be either Smooth (default: all points are smooth) or Corner points. These Corner points result in a sharp angle. They are displayed using a diamond shape. You can toggle between Smooth and Corner for the selected point.

Curve type

Smooth This Smooth option affects the whole curve, not only the selected point as above.

Free Hand With this mode, you can draw a free hand line that you can smooth by clicking the Smooth Curve type.

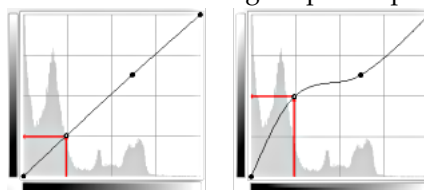
16.8.11.3 Using "Curves"

16.8.11.3.1 Summary and basic shapes

We create points and segments on the curve and we move them to shape the curve. This curve maps "input" tones of the active layer or selection to "output" tones.

16.8.11.3.1.1 How the Curves tool works

Moving the point a pixel upwards makes this pixel brighter.

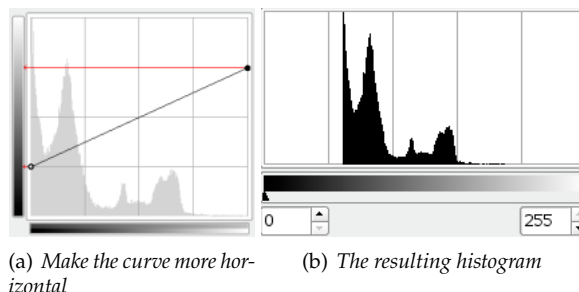


Moving the point upwards

16.8.11.3.1.2 Making the curve more horizontal Making the curve more horizontal forces all the input tonal range to occupy a shrunk output tonal range.

The histogram shows the compression of pixels into the output range. Darkest and brightest pixels disappeared: contrast decreases.

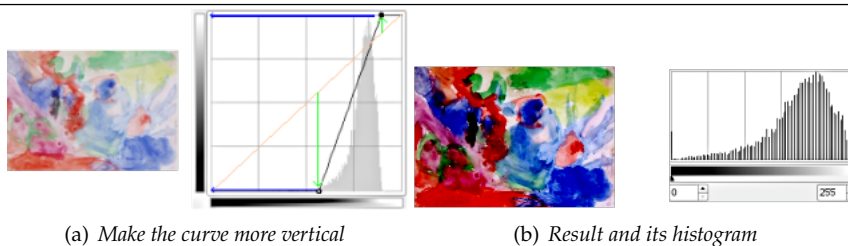
Figure 16.163 Making the curve more horizontal



16.8.11.3.1.3 Making the curve more vertical Moving the upper end point to the left and the lower end point to the right is the same as moving the white slider to the left and the black slider to the right in the Levels tool: all pixels whose value is more than the white point (the flat part of the curve) are made white (more colored / more opaque according to the selected channel). All pixels whose value is less than the black point (the lower flattened curve) are made black (black / completely transparent). Pixels corresponding to points of the curve that have moved up are made lighter. Pixels corresponding to points of the curve that have moved down are made darker (green arrows). All these pixels will be extended to the whole output tonal range.

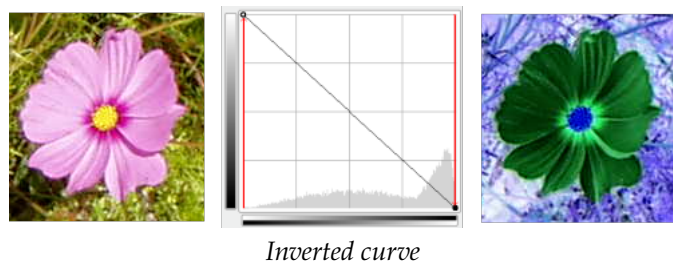
The histogram shows the extension of values, from black (0) to White (255): contrast is increased. Since the Value channel is selected, changes affect all color channels and colors increase.

Figure 16.164 Making the curve more vertical



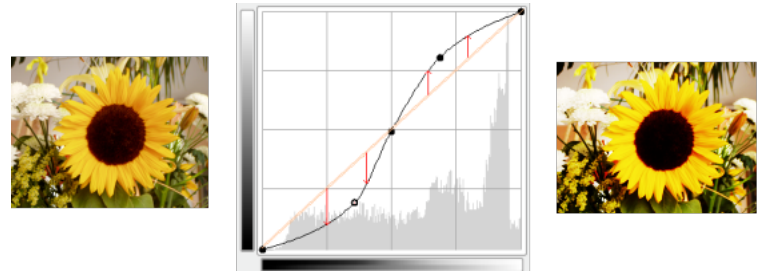
16.8.11.3.2 Practical cases

16.8.11.3.2.1 Invert colors



Black is made White (fully colored / fully opaque). White is made black (black, fully transparent). All pixels adopt the complementary color. Why that? Because subtracting the channel values from 255 gives the complementary color. For example: 19;197;248 a sky blue gives 255-19; 255-197; 255-248 = 236;58;7, a bright red.

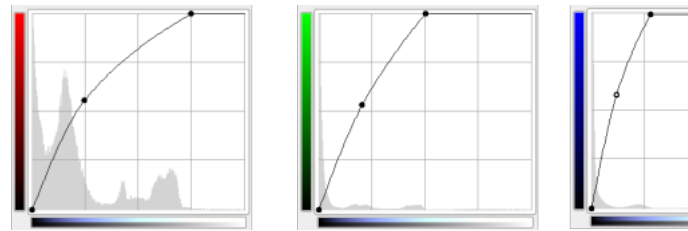
16.8.11.3.2.2 Enhance contrast



Contrast enhanced

Contrast is increased in mid tones because the curve is steeper there. Highlights and Shadows are increased but contrast is slightly less in these areas because the curve is flatter.

16.8.11.3.2.3 Working on color channels



For every channel, we moved the white point horizontally to the left, to the first Highlights. This lightens Highlights up. Then we shaped the curve to lighten Mid tones and Shadows while keeping black.



The original image and the result

16.8.12 Invert

The Invert command inverts all the pixel colors and brightness values in the current layer, as if the image were converted into a negative. Dark areas become bright and bright areas become dark. Hues are replaced by their complementary colors. For more information about colors, see the Glossary entry about [Color Model](#).

Note



This command only works on layers of RGB and Grayscale images. If the current image is Indexed, the menu entry is disabled.

Warning



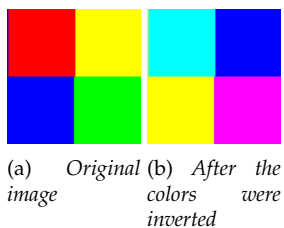
Do not confuse this command with the [Invert Selection](#) command.

16.8.12.1 Activate the Command

You can access this command from the image menubar through Colors → Invert.

16.8.12.2 Example

Figure 16.165 Applying "Invert colors"



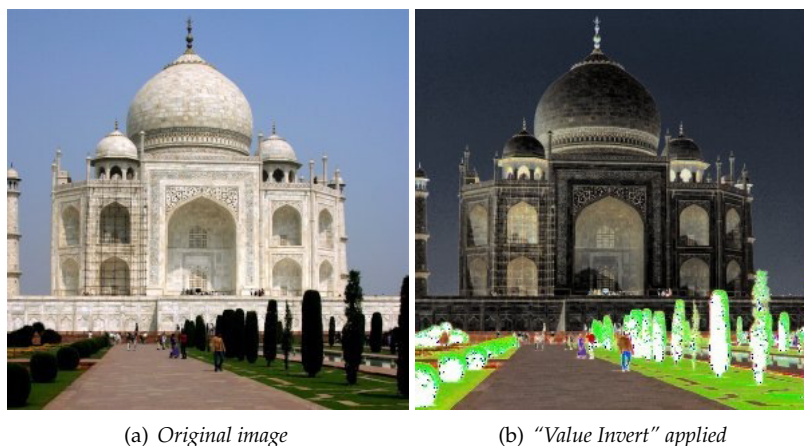
16.8.13 Linear Invert

TODO

16.8.14 Value Invert

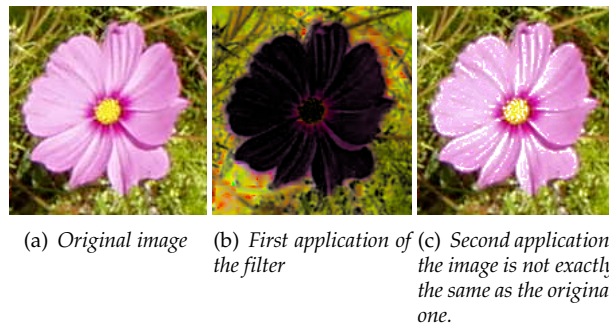
16.8.14.1 Overview

Figure 16.166 Example for the "Value invert" filter



This filter inverts Value (luminosity) of the active layer or selection. Hue and Saturation will not be affected, although the color will sometimes be slightly different because of round-off error. If you want to invert Hue and Saturation also, use Colors → Invert.

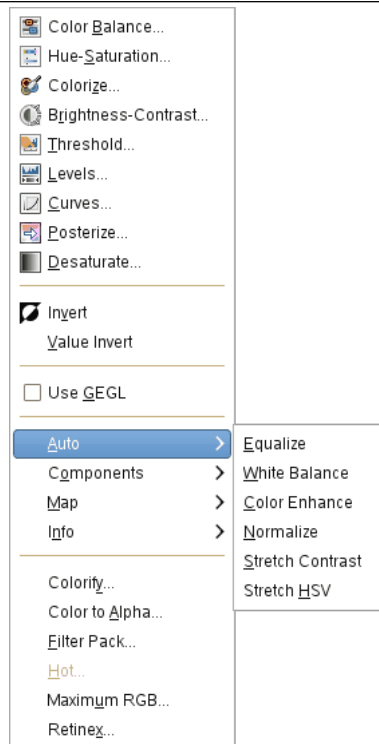
Note that hue and saturation can be distorted quite a bit when applying twice this filter for colors with a high luminosity (for instance, HSV 102°, 100%, 98%, a bright green, gives HSV 96°, 100%, 2% after a first application of the filter, and 96°, 100%, 98% after a second application). Thus, you should not expect to be able to apply this filter twice in a row and get back the image you started with.

Figure 16.167 Example of using this filter twice

16.8.14.2 Activate the filter

You can access this command from the image menu bar through Colors → Value Invert.

16.8.15 The "Auto" Submenu

Figure 16.168 The "Colors/Auto" submenu

The Auto submenu contains operations which automatically adjust the distribution of colors in the active layer, without requiring any input from the user. Several of these operations are actually implemented as plugins.

16.8.15.1 Activate submenu

- You can access this submenu from the image window through Colors → Auto.

16.8.15.2 Automatic Color-Stretching

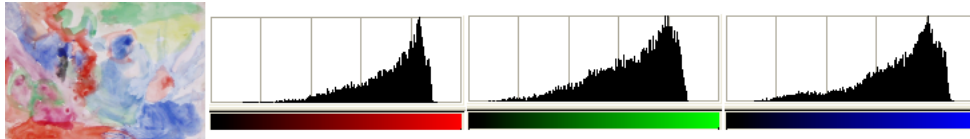
GIMP has several automatic commands for stretching the columns of the histogram for the color channels of the active layer. By pushing bright pixels to the right and dark pixels to the left, they make bright pixels brighter and dark pixels darker, which enhances the contrast in the layer.

Some of the commands stretch the three color channels equally, so that the hues are not changed. Other commands stretch each of the color channels separately, which changes the hues.

The way the stretching is done varies with the different commands and the results look different. It is not easy to predict exactly what each command will do. If you know exactly what you are doing, you can get the same results, and even more, with the **Levels** tool.

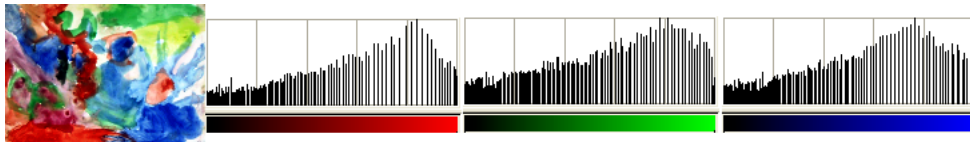
Here are examples of the results of these commands, all together on one page, so you can compare them more easily. The most appropriate command depends upon your image, so you should try each of them to see which command works best on it.

Figure 16.169 The original layer and its histograms



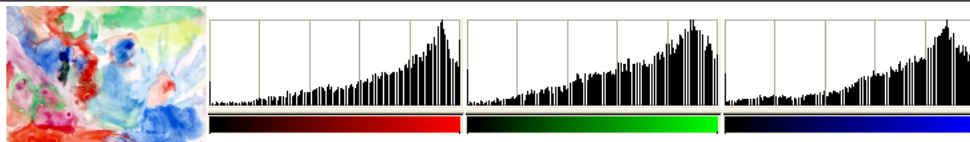
This layer doesn't have any very bright or very dark pixels, so it works well with these commands.

Figure 16.170 The **Equalize** command



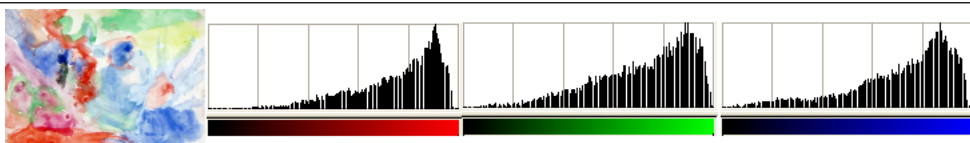
"Equalize" example

Figure 16.171 The **White Balance** command



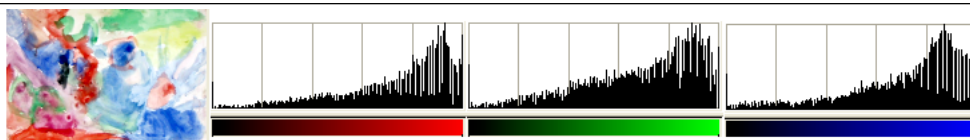
"White Balance" example

Figure 16.172 The **Stretch Contrast** command

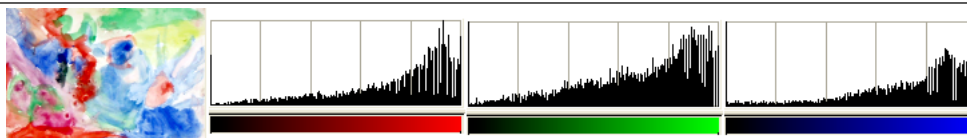


"Stretch Contrast" example

Figure 16.173 The **Stretch Contrast HSV** command



"Stretch Contrast HSV" example

Figure 16.174 The **Color Enhance** command*"Color Enhance" example*

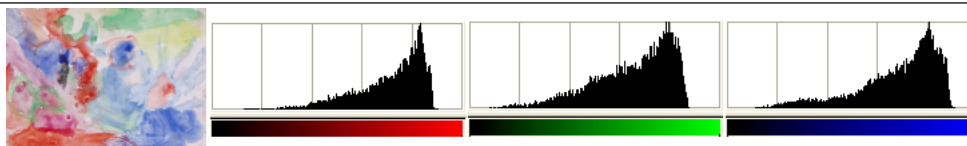
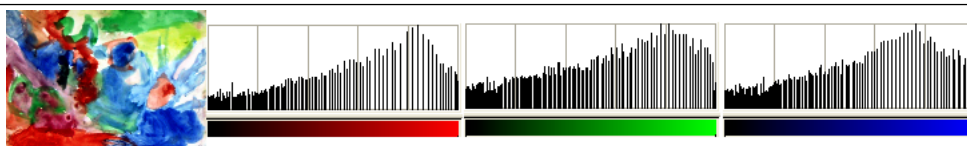
16.8.16 Equalize

The Equalize command automatically adjusts the brightness of colors across the active layer so that the histogram for the Value channel is as nearly flat as possible, that is, so that each possible brightness value appears at about the same number of pixels as every other value. You can see this in the histograms in the example below, in that pixel colors which occur frequently in the image are stretched further apart than pixel colors which occur only rarely. The results of this command can vary quite a bit. Sometimes "Equalize" works very well to enhance the contrast in an image, bringing out details which were hard to see before. Other times, the results look very bad. It is a very powerful operation and it is worth trying to see if it will improve your image. It works on layers from RGB and Grayscale images. If the image is Indexed, the menu entry is insensitive and grayed out.

16.8.16.1 Activate the Command

You can access this command from the image menubar through Colors → Auto → Equalize

16.8.16.2 "Equalize" example

Figure 16.175 Original image*The active layer and its Red, Green, Blue histograms before "Equalize".***Figure 16.176** Image after the command*The active layer and its Red, Green, Blue histograms after treatment.*

Histogram stretching creates gaps between pixel columns giving it a striped look: colors that occur frequently are stretched.

16.8.17 White Balance

The White Balance command automatically adjusts the colors of the active layer by stretching the Red, Green and Blue channels separately. To do this, it discards pixel colors at each end of the Red, Green and Blue histograms which are used by only 0.05% of the pixels in the image and stretches the remaining range as much as possible. The result is that pixel colors which occur very infrequently at the outer edges of the histograms (perhaps bits of dust, etc.) do not negatively influence the minimum and maximum values used for stretching the histograms, in comparison with **Stretch Contrast**. Like "Stretch Contrast", however, there may be hue shifts in the resulting image.

This command suits images with poor white or black. Since it tends to create pure white (and black), it may be useful e.g. to enhance photographs.

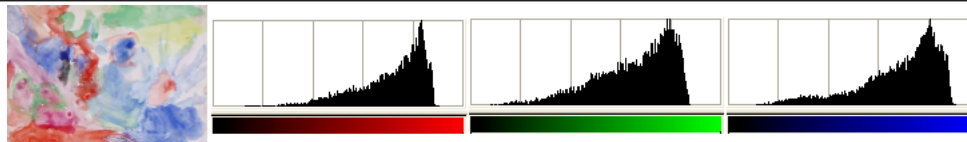
White Balance operates on layers from RGB images. If the image is Indexed or Grayscale, the menu item is insensitive and grayed out.

16.8.17.1 Activate the Command

- You can access this command from the image menubar through Colors → Auto → White Balance.

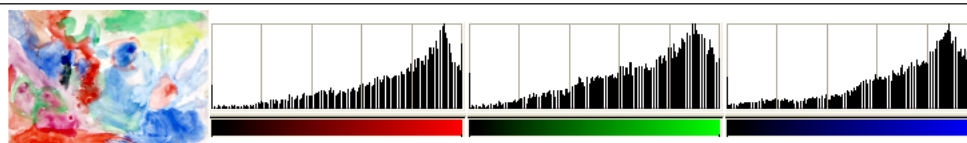
16.8.17.2 “White Balance” example

Figure 16.177 Original image



The active layer and its Red, Green and Blue histograms before “White Balance”.

Figure 16.178 Image after the command



The active layer and its Red, Green and Blue histograms after “White Balance”. Poor white areas in the image became pure white.

Histogram stretching creates gaps between the pixel columns, giving it a striped look.

16.8.18 Stretch Contrast

The Stretch Contrast command automatically stretches the histogram values in the active layer. For each channel of the active layer, it finds the minimum and maximum values and uses them to stretch the Red, Green and Blue histograms to the full contrast range. The bright colors become brighter and the dark colors become darker, which increases the contrast. “Stretch Contrast” works on layers of RGB, Grayscale and Indexed images. Use “Stretch Contrast” only if you want to remove an undesirable color tint from an image which should contain pure white and pure black.

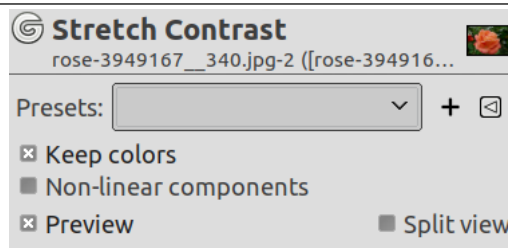
This command is also similar to the **Color Balance** command, but it does not reject any of the very dark or very bright pixels, so the white might be impure.

16.8.18.1 Activate the Command

- This command can be accessed from an image menubar as Colors → Auto → Stretch Contrast.

16.8.18.2 Options

Figure 16.179 “Stretch Contrast” settings



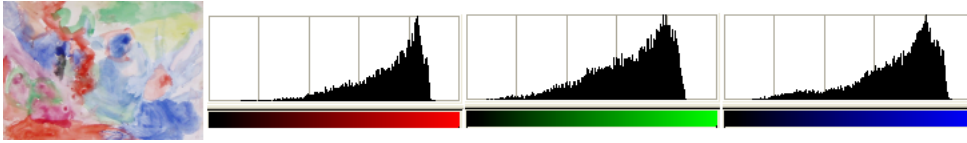
Presets, Preview, Split view These options are common to GEGL-based filters. Please refer to Section 17.2.

Keep Colors Impact each color channel with the same amount.

Non-Linear Components When set, this option operates on gamma corrected values instead of linear RGB, acting like the old Normalize filter.

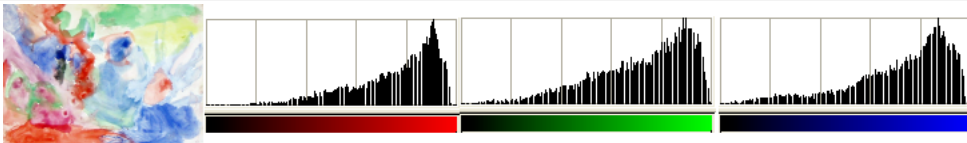
16.8.18.3 "Stretch Contrast" Example

Figure 16.180 Original image



The layer and its Red, Green and Blue histograms before "Stretch Contrast".

Figure 16.181 Image after the command



The layer and its Red and Green and Blue histograms after "Stretch Contrast". The pixel columns do not reach the right end of the histogram (255) because of a few very bright pixels, unlike "White Balance". Histogram stretching creates gaps between the pixel columns, giving it a stripped look.

16.8.19 Stretch HSV

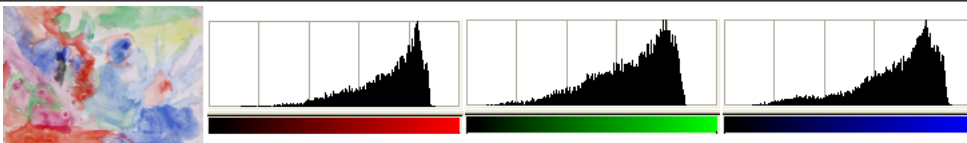
The Stretch Contrast HSV command does the same thing as the **Stretch Contrast** command, except that it works in HSV color space, rather than RGB color space, and it preserves the Hue. Thus, it independently stretches the ranges of the Hue, Saturation and Value components of the colors. Occasionally the results are good, often they are a bit odd. "Stretch Contrast HSV" operates on layers from RGB and Indexed images. If the image is Grayscale, the menu entry is insensitive and grayed out.

16.8.19.1 Activate the Command

- You can access this command from the image menubar through Colors → Auto → Stretch Contrast HSV.

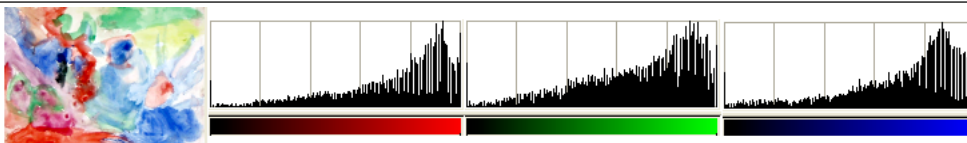
16.8.19.2 "Stretch Contrast HSV" example

Figure 16.182 Original image



The active layer and its Red, Green and Blue histograms before "Stretch Contrast HSV".

Figure 16.183 Image after the command



The active layer and its Red, Green and Blue histograms after "Stretch Contrast HSV". Contrast, luminosity and hues are enhanced.

16.8.20 Color Enhance

TODO

16.8.21 Color Enhance (legacy)

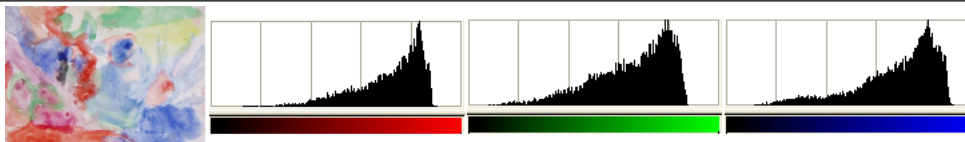
The Color Enhance command increases the saturation range of the colors in the layer, without altering brightness or hue. It does this by converting the colors to HSV space, measuring the range of saturation values across the image, then stretching this range to be as large as possible, and finally converting the colors back to RGB. It is similar to **Stretch Contrast**, except that it works in the HSV color space, so it preserves the hue. It works on layers from RGB and Indexed images. If the image is Grayscale, the menu entry is insensitive and grayed out.

16.8.21.1 Activate the command

- You can access this command from the image menubar through Colors → Auto → Color Enhance (legacy).

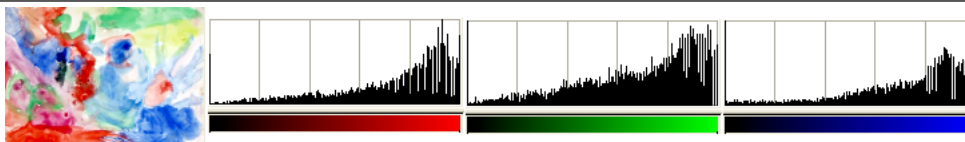
16.8.21.2 "Color Enhance (legacy)" example

Figure 16.184 Original image



The active layer and its Red, Green and Blue histograms before "Color Enhance".

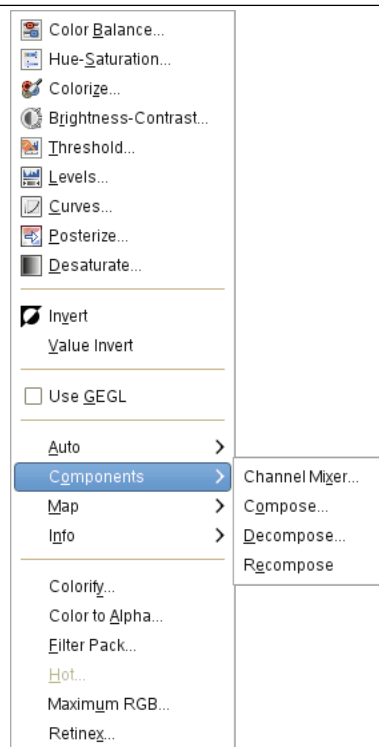
Figure 16.185 Command applied



The active layer and its Red, Green and Blue histograms after "Color Enhance (legacy)". The result may not always be what you expect.

16.8.22 The "Components" Submenu

This command leads to the following submenu

Figure 16.186 The “Components” submenu

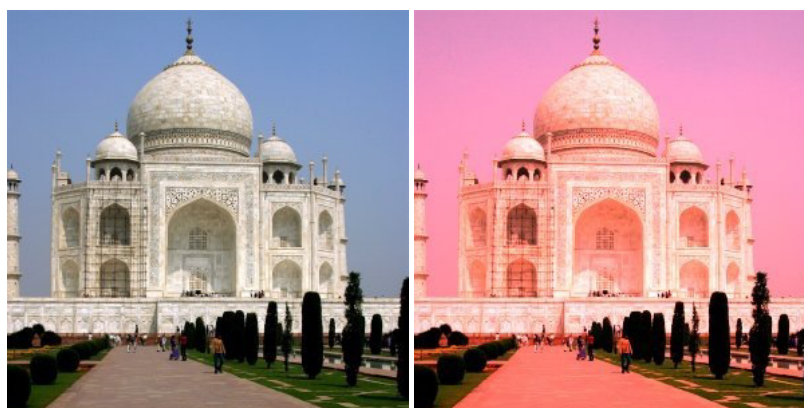
- Section [16.8.23](#)
- Section [16.8.26](#)
- Section [16.8.27](#)
- Section [16.8.28](#)

16.8.22.1 Activating the command

This command is found in the image window menu under Colors → Components.

16.8.23 Channel Mixer

16.8.23.1 Overview

Figure 16.187 Example for the “Channel Mixer” filter

(a) Original image

(b) “Channel Mixer” applied

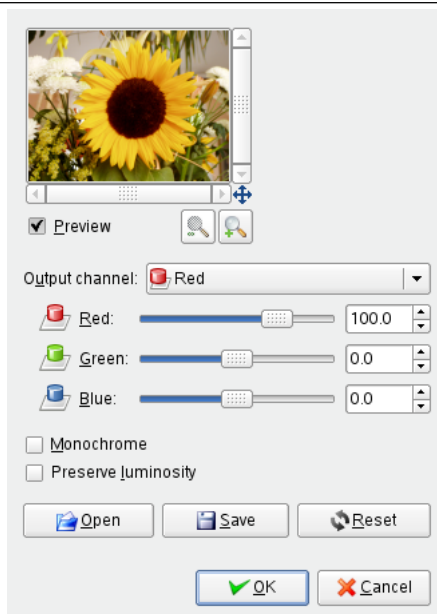
This command combines values of the RGB channels. It works with images with or without an alpha channel. It has monochrome mode and a preview.

16.8.23.2 Activate the command

You can find this command through Colors → Components → Channel Mixer.

16.8.23.3 Options

Figure 16.188 "Channel Mixer" command options



Output Channel From this menu you select the channel to mix to. Choices are Red, Green, or Blue. It is insensitive when Monochrome option is checked.

Red, Green, Blue These three sliders set the contribution of red, green or blue channel to output. Can be negative. These sliders are graduated from -200 to 200. They represent the percentage which will be attributed to the output channel. 100% corresponds to the value of the channel of the studied pixel in the image.

Monochrome This option converts the RGB image into a gray-scale RGB image. The Channel Mixer command is often used with this aim in view, because it often provides a better result than the other ways (see [Grayscale](#) in Glossary). Makes the Output Channel menu insensitive.

Note



The 21%, 72%, 7% settings give you the same gray luminosity (Value) as the Grayscale command in Image/Mode. (They were 30%, 59%, 11% in v2.2).

Preserve Luminosity Calculations may result in too high values and an image too much clear. This option lessens luminosities of the color channels while keeping a good visual ratio between them. So, you can change the relative weight of the colors without changing the overall luminosity.

16.8.23.4 Buttons

Open Load settings from a file.

Save Save settings to a file.

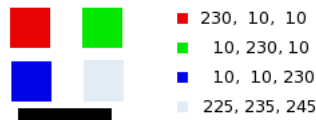
Reset Set default settings.

16.8.23.5 How does Channel Mixer work?

In RGB mode In this mode, you have to select an Output Channel . This channel is the one which will be modified. In the dialog window, its default value is 100%, corresponding to the value of the channel in the original image. It can be increased or decreased. That's why slider ends are -200 and 200.

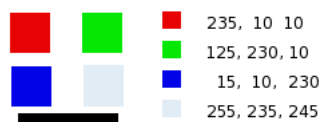
Three RGB sliders let you give a percentage to every channel. For every pixel in the image, the sum of the calculated values for every channel from these percentages will be given to the Output Channel. Here is an example:

Figure 16.189 The original image and its channels



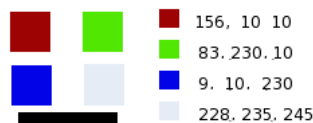
RGB values of the pixels in red, green, blue, gray squares are displayed. The black rectangle is special, because black (0;0;0) is not concerned by the command (0 multiplied by any percentage always gives 0). The result can't exceed 255 nor be negative.

Figure 16.190 Output channel is red. Green Channel +50



In the red square, the pixel values are 230;10;10. Relative values are 1;0.5;0. The calculation result is $230*1 + 10*0.5 + 10*0 = 235$. The same reasoning is valid for the green and the blue squares. In the gray square, which contains red color, the calculation result is above 255. It is reduced to 255. A negative value would be reduced to 0.

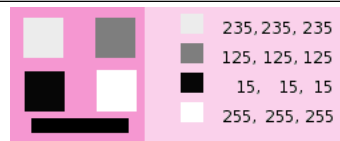
Figure 16.191 Output channel is red. Green Channel +50%. The Preserve Luminosity option is checked.



The values attributed to the Red Output channel are lower, preventing a too much clear image.

In Monochrome mode When this option is checked, the image preview turns to grayscale, but the image is still a RGB image with three channels, until the command action is validated.

Figure 16.192 Monochrome option checked. Red: 100% Green: 50% Blue: 0%. Preserve Luminosity unchecked.



In every square, pixels have been converted into a gray level equal to the value of the Red channel in the original image (The background has been painted with pink afterwards to make all squares visible).

Here is how the Preserve Luminosity works in the monochrome mode: “ For example, suppose the sliders were Red:75%, Green:75%, Blue:0%. With Monochrome on and the Preserve Luminosity option off, the resulting picture would be at 75%+75%+0% =150%, very bright indeed. A pixel with a value of, say, R,G,B=127,100,80 would map to 127*0.75+100*0.75+80*0=170 for each channel. With the Preserve Luminosity option on, the sliders will be scaled so they always add up to 100%. In this example, that scale value is 1/(75%+75%+0%) or 0.667. So the pixel values would be about 113. The Preserve Luminosity option just assures that the scale values from the sliders always adds up to 100%. Of course, strange things happen when any of the sliders have large negative values ” (from the plug-in author himself).

Note

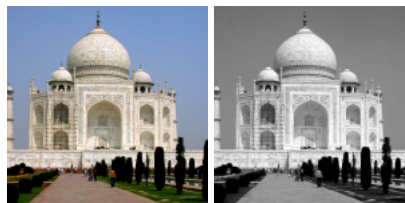


Which channel will you modify? This depends on what you want to do. In principle, the Red channel suits contrast modifications well. The Green channel is well adapted to details changes and the Blue channel to noise, grain changes. You can use the **Decompose** command.

16.8.24 Extract Component

16.8.24.1 Overview

Figure 16.193 Extract Component applied



(a) Original image

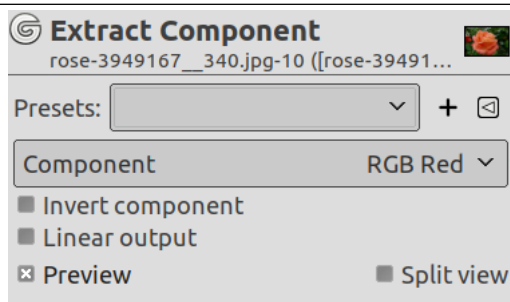
(b) Command “Extract Component” applied with default options.

16.8.24.2 Activate the command

- You can find this command in the image window menu under Colors → Components → Extract Component....

16.8.24.3 Options

Figure 16.194 "Extract Component" command options



Presets, Preview, Split view These options are common to GEGL-based filters. Please refer to Section 17.2.

Component Component to extract. Default is RGB Red: all layer pixels that have the red component in their color will be extracted to create gray pixels; gray pixel value is that of the red channel (e.g a 153;70;17 RGB pixel will give a 153;153;153 gray pixel).

Invert Invert the extracted component.

Linear input Use linear input instead of gamma corrected.

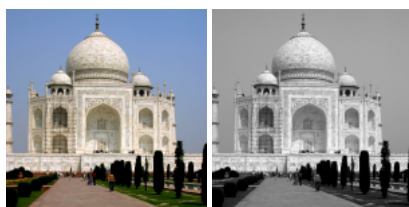
16.8.24.4 Using Extract Component

What can we do with that?

16.8.25 Mono Mixer

16.8.25.1 Overview

Figure 16.195 Mono-mixer applied



(a) Original image

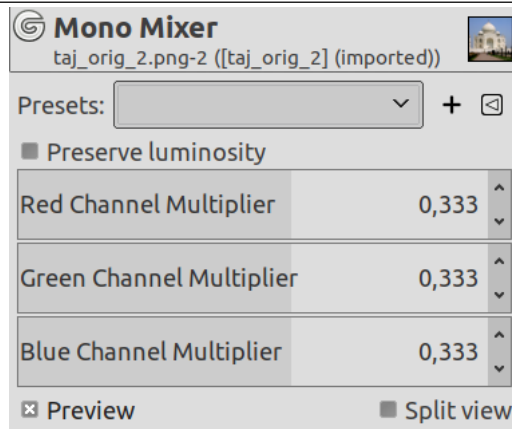
(b) Command "Mono-mixer" applied with default options.

16.8.25.2 Activate the command

- You can find this command in the image window menu under Colors → Components → Mono Mixer...

16.8.25.3 Options

Figure 16.196 “Mono Mixer” command options



Presets, Preview, Split view These options are common to GEGL-based filters. Please refer to Section 17.2.

Preserve luminosity Calculations may result in too high values and an image too much clear. This option lessens luminosities of the color channels while keeping a good visual ratio between them. So, you can change the relative weight of the colors without changing the overall luminosity.

Red Channel Multiplier, Green Channel Multiplier, Blue Channel Multiplier Coefficient applied to each channel. Values range from -5.000 to 5.000. As default values are equal in the three channels, image is grayed out.

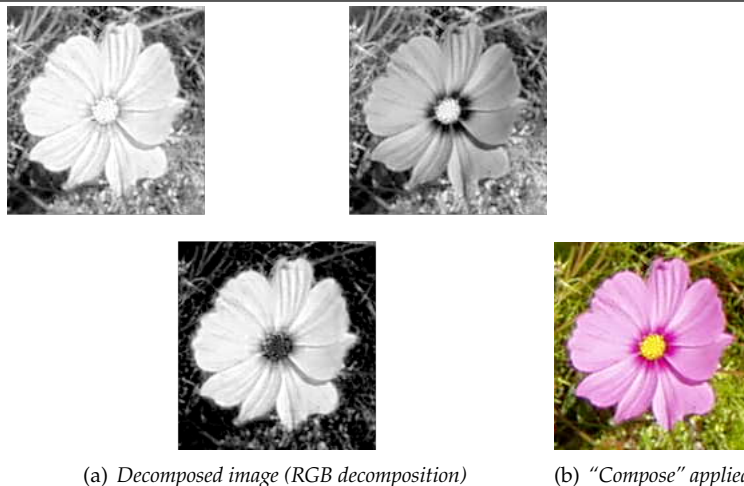
16.8.25.4 Using Channel Mixer

TODO

16.8.26 Compose

16.8.26.1 Overview

Figure 16.197 Example for the “Compose” command



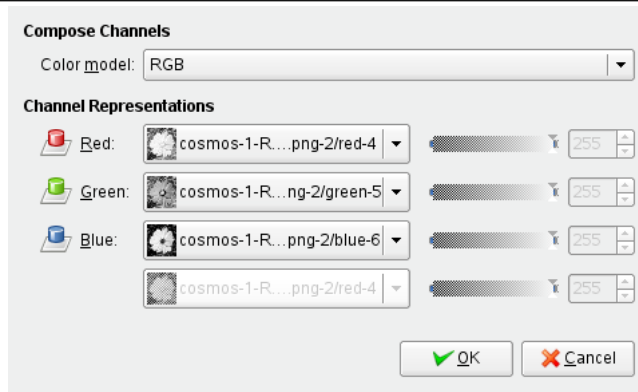
This command constructs an image from several grayscale images or layers, for instance from extracted RGB, HSV... components. You can also build an image from grayscale images or layers created independently.

16.8.26.2 Activate the command

- You can find this command in the image window menu under Colors → Components → Compose... It is enabled if your image is grayscale.

16.8.26.3 Options

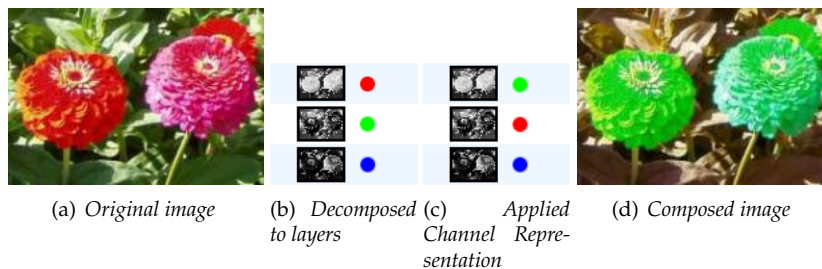
Figure 16.198 "Compose" command options



Compose Channels You can select there the color space to be used: RGB, HSV... The options are described in the following **Decompose** command.

Channel Representation Allows you to select which channel will be affected to each image channel. You may use this option, for example, to exchange color channels:

Figure 16.199 Channel Representation example: exchange two channels



Mask Value: Instead of selecting a layer or an image to build the channel, you can give the channel a value from 0 to 255. But note that at least one channel must be formed from a layer or image.

Tip



If Compose options are different from Decompose ones, for instance an image decomposed to **RGB** then re-composed to **LAB**, you will get interesting color effects. Test it!

16.8.27 Decompose

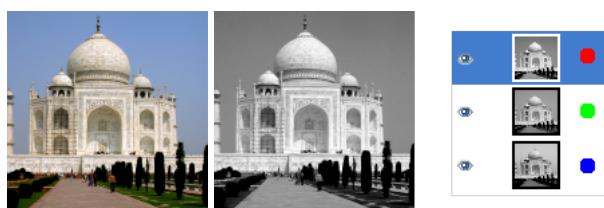
16.8.27.1 Overview

Figure 16.200 Decomposition to images (RGB)



(a) Original image (b) Command "Decompose" applied (RGB decomposition) with Decompose to layers unchecked.

Figure 16.201 Decomposition to layers (RGB)



(a) Original image (b) Command "Decompose" applied (RGB decomposition) with Decompose to layers checked.

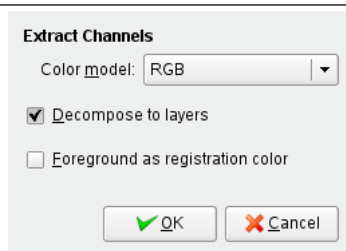
This command separates the channels (RGB, HSV, CMYK...) of an image into separated images or layers.

16.8.27.2 Activate the command

- You can find this command in the image window menu under Colors → Components → Decompose....

16.8.27.3 Options

Figure 16.202 "Decompose" command options



Extract Channels

Following options are described with **Decompose to layers** checked.

Color model

RGB If the RGB radio button is clicked, a grey level image is created with three layers (Red, Green and Blue), and two channels (Grey and Alpha).

This function is interesting when using Threshold tool. You can also perform operations like cutting, pasting or moving selections in a single RGB channel. You can use an extracted grayscale as a selection or mask by saving it in a channel (right-click>Select>Save to a channel).

RGBA If the RGBA radio button is clicked, a image is created similar at the RGB Decomposing with a additional Alpha layer filled with the transparencies values of the source image. Full transparent pixels are black and the full opaque pixels are white.

HSV This option decomposes image into three greyscaled layers, one for Hue, one for Saturation and another for Value.

Although Hue is greyscaled, it does represent hues. In color circle, white and black are starting and arrival points and are superimposed. They represent Red color at top of circle. Grey intermediate levels are corresponding to intermediate hues on circle: dark grey to orange, mid grey to green and light grey to magenta.

Saturation and Value: White is maximum Saturation (pure color) and maximum Value (very bright). Black is minimum Saturation (white) and minimum Value (black).

HSL This option is similar to HSV. Instead of the Value, the third layer contains the image's L component.

CMY This option decomposes image into three greyscaled layers, one for Yellow, one for Magenta and another for Cyan.

This option might be useful to transfer image into printing software with CMY capabilities.

CMYK This option is similar at the CMY Decomposing with an additional layer for Black.

This option might be useful to transfer image into printing software with CMYK capabilities.

Alpha This option extracts the image transparency stored in the Alpha channel in **Channel dialog** in a separate image. The full transparent pixels are Black the full opaque pixels are white. The graytones are smooth transitions of the transparency in the source image.

LAB This option decomposes image into three greyscaled layers, layer "L" for Luminance, layer "A" for colors between green and red, layer "B" for colors between blue and yellow.

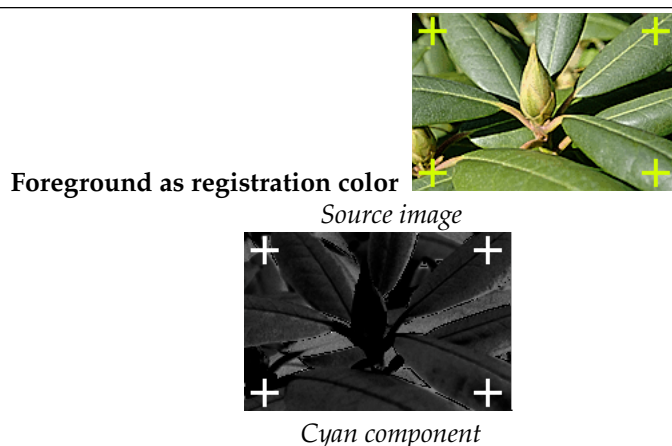
The LAB Decomposing is a color model of the Luminance-Color family. A channel is used for the Luminosity while two other channels are used for the Colors. The LAB color model is used by Photoshop.

YCbCr In GIMP there is four YCbCr decompositions with different values. Each option decomposes image in three greyscaled layers, a layer for Luminance and two other for blueness and redness.

The YCbCr color model also called YUV is now used for digital video (initially for PAL analog video). It's based on the idea that the human eye is most sensitive to luminosity, next to colors. The YCbCr Decomposing use a transformation matrix and the different options are different values recommended by ITU (International Telecommunication Union) applied to the matrix

Decompose to Layers If this option is checked, a new grey-scaled image is created, with each layer representing one of the channels of the selected mode. If this option is not checked, every channel is represented with a specific image automatically and clearly named in the name bar.

Example 16.1 Crop marks



*Black component*

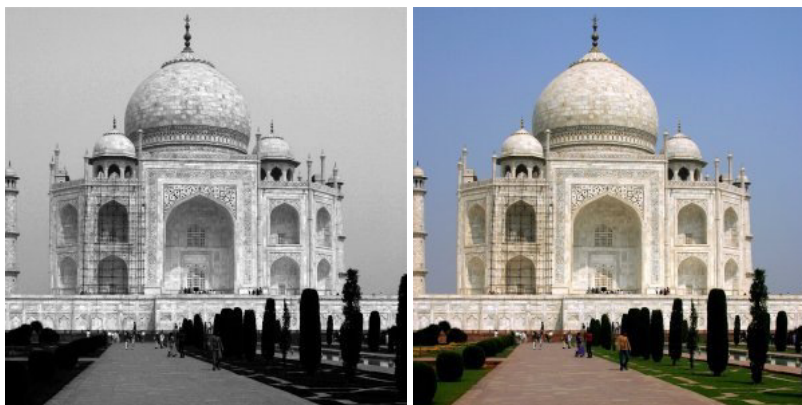
(Magenta and Yellow components omitted.)

This option is for specialists. It is related to CMYK printing. When checked, every pixel of the current foreground color will be black in each component of the decomposed images/layers. This allows you to make crop marks visible on all channels, providing a useful reference for alignment. A thin cross printed in registration black can also be used to check whether the printing plates are lined up.

16.8.28 Recompose

16.8.28.1 Overview

Figure 16.203 Example for the "Recompose" command



(a) Original image (decomposed to RGB)

(b) Command "Recompose" applied

This command reconstructs an image from its RGB, HSV... components directly, unlike the **Compose** command which uses a dialog.

16.8.28.2 Activate the command

- This command is found in the image window menu under Colors → Components → Recompose: This command is active after using Decompose.

16.8.29 Color to Gray

TODO

16.8.30 Desaturate

By using the Desaturate command, you can convert all of the colors on the active layer to corresponding shades of gray. This differs from converting the image to grayscale in two respects. First, it only operates on the active layer and second, the colors on the layer are still RGB values with three components, with $R=G=B$, which makes gray. This means that you then can paint on the layer, or individual parts of it, using non-gray colors.

Note



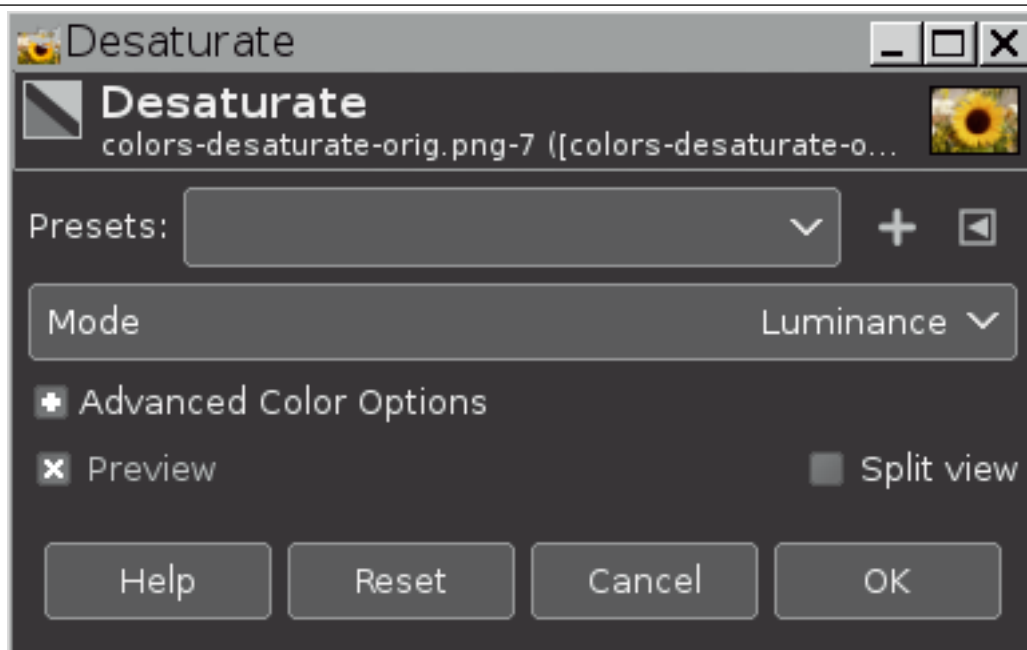
This command only works on layers of **RGB** images. If the image is in Grayscale or Indexed mode, it can do nothing.

16.8.30.1 Activating the Command

You can find this command through Colors → Desaturate → Desaturate...

16.8.30.2 Options

Figure 16.204 The "Desaturate" option dialog



Mode: Five options are available for converting from color to black and white:

Luminance The shades of gray will be calculated using **linearized sRGB** as

$$\text{Luminance} = (0.22 \times R) + (0.72 \times G) + (0.06 \times B)$$

Luma The shades of gray will be calculated using non-linearized sRGB

$$\text{Luma} = (0.22 \times R) + (0.72 \times G) + (0.06 \times B)$$

Lightness (HSL) The shades of gray will be calculated as

$$\text{Lightness (HSL)} = \frac{1}{2} \times (\max(R,G,B) + \min(R,G,B))$$

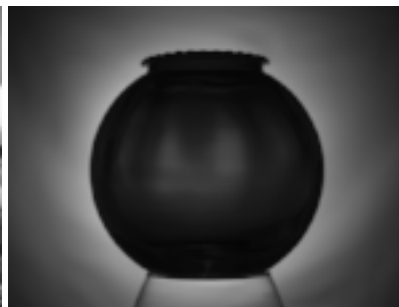
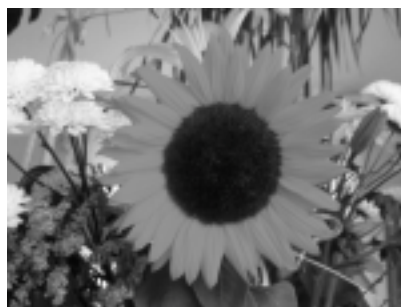
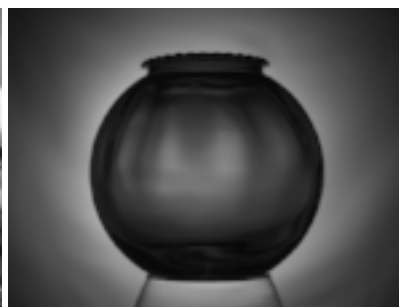
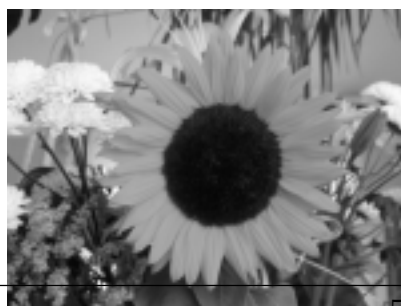
Average (HSI Intensity) The shades of gray will be calculated as

$$\text{Average (HSI Intensity)} = (R + G + B) \div 3$$

Value (HSV) The shades of gray will be calculated as

$$\text{Value (HSV)} = \max(R,G,B)$$

Figure 16.205 Using the five modes to convert two very different color images to black and white

(a) *Original image*(b) *Original image*(c) *"Luminance" applied*(d) *"Luminance" applied*(e) *"Luma" applied.*(f) *"Luma" applied.*(g) *"Lightness (HSL)" applied.*(h) *"Lightness (HSL)" applied.*(i) *"Average (HSI Intensity)" applied.*(j) *"Average (HSI Intensity)" applied.*

16.8.30.3 Comparing results from using different options for converting from color to black and white:

1. The degree and direction from which the various ways to convert an image to black and white diverge from a straight Luminance conversion to black and white depends on:
 - The conversion method you choose.
 - The RGB color space in which the conversion is done.
 - How saturated the colors in the original image happen to be, with more saturated starting colors (such as the red globe and the bright yellow sunflower) producing greater amounts of deviation from a straight Luminance conversion.
 - The hues (for example yellows vs reds) of the various saturated colors in an image also make a difference.
 - Being the maximum of the RGB channel values for each pixel, an HSV Value conversion to black and white is always lighter than the original color image, and also lighter than all the other ways to convert to black and white.
2. Comparing the red globe to the yellow sunflower:
 - For the red globe Lightness (HSL) produces a result very similar to Luminance, and Luma produces a conversion that is much darker.
 - For the sunflower, Luma produces a result very similar to Luminance, and Lightness (HSL) produces a conversion that is much darker.
 - Notice that the less saturated parts of each image look more or less the same, regardless of which method is chosen for converting from color to black and white.

16.8.30.4 More information about the five options for converting from color to black and white:

1. *More information about Luminance:*
 - "Luminance" is the only physically meaningful way to convert a color image to black and white, as the resulting black and white image has the same relative luminance (reflects the same percentage of light from the various shades of gray) as the colors in the original color image.
 - Luminance must be calculated using linearized RGB values.
 - For convenience we say "Luminance", but what we really mean is "Relative Luminance". For more information, see [Relative Luminance](#) and [CIE 1931 \[XYZ\] color space](#).
 - GIMP 2.10 uses hard-coded sRGB values to do Luminance conversions to black and white. "Future GIMP" will support correct conversions for images in other color spaces.
2. *More information about Luma:*
 - "Luma" is what you get if you use the formula for Luminance on RGB values that haven't been properly linearized. Luma corresponds to GIMP 2.8's "Luminosity" method of converting to black and white.
 - Compared to GIMP 2.8, GIMP 2.10's "Luma" option uses slightly different multipliers. Unlike the GIMP 2.8 multipliers, the GIMP 2.10 multipliers have been properly Bradford-adapted from D65 to D50, which is required for use in an ICC profile color-managed editing application (at least until the next version of the ICC specs is released and people figure out how to deal with the new freedom to use non-D50 reference white points).
 - GIMP 2.10 uses hard-coded sRGB values to do Luma conversions to black and white. "Future GIMP" will support correct conversions for images in other color spaces.
3. *More information about Lightness, Average, and Value:*

The "Lightness (HSL)", "Average (HSI Intensity)", and "Value (HSV)" ways to convert a color image to black and white use color space models that were invented for fast processing on consumer-grade computers from the 1990s. For details see [HSL and HSV](#), paying particular attention to the section on [Disadvantages](#).

4. In case you are wondering why LAB Lightness is not among the options for converting an RGB image to black and white, a properly calculated conversion from RGB to LAB Lightness, and then back to RGB, produces exactly the same result as the Luminance conversion to black and white. Here is why:

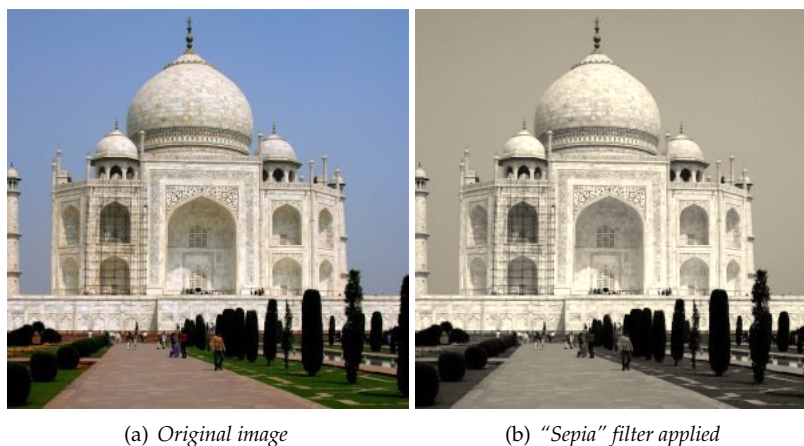
- In the XYZ color space, Y is Luminance. So if you convert a color RGB image to XYZ, the "Y" of XYZ is the same number as the R=G=B values that you get when you calculate RGB Luminance.
- LAB is a perceptually uniform transform of XYZ. If you convert from RGB to XYZ and then to LAB, and set A=B=0.0 (or 0.5 for image editors that put the midpoint of the A and B axes as 0.5 instead of at 0.0), and then convert back to XYZ, the X and Z values will change, but Y will not change.

Tutorials that produce anything other than Relative Luminance when converting an RGB image to black and white using LAB Lightness, very sadly are trading on various mathematical mistakes in the conversion routines.

16.8.31 Sepia

16.8.31.1 Overview

Figure 16.206 Example for the "Sepia" filter



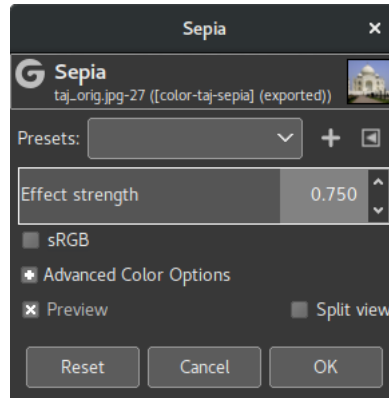
The Sepia filter imitates sepia toning to produce a black-and-white picture with a warm brown-ish tone.

16.8.31.2 Activate the filter

You can find this command through Colors → Desaturate → Sepia....

16.8.31.3 Options

Figure 16.207 "Sepia" options



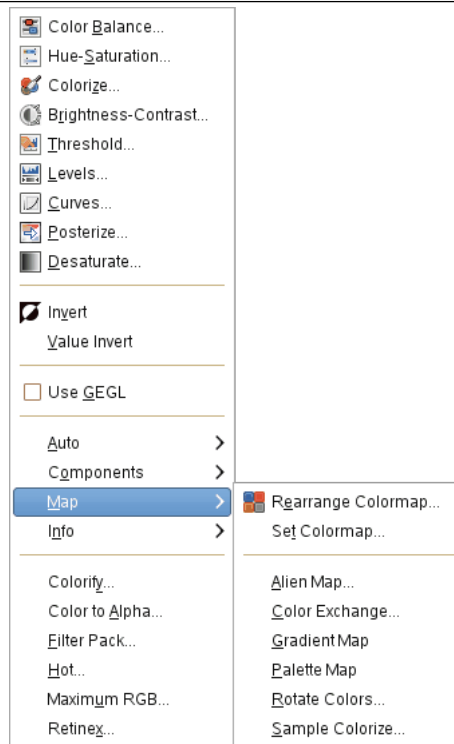
Effect strength This handle lets you control how much the effect blends into the original image. 0.000 is no effect at all, 1.000 is completely replacing the image with its sepia-toned version.

sRGB This checkbox allows you processing the image in either sRGB gamma-corrected or linear color space.

16.8.32 The "Map" Submenu

This command leads to the following submenu

Figure 16.208 The "Map" submenu

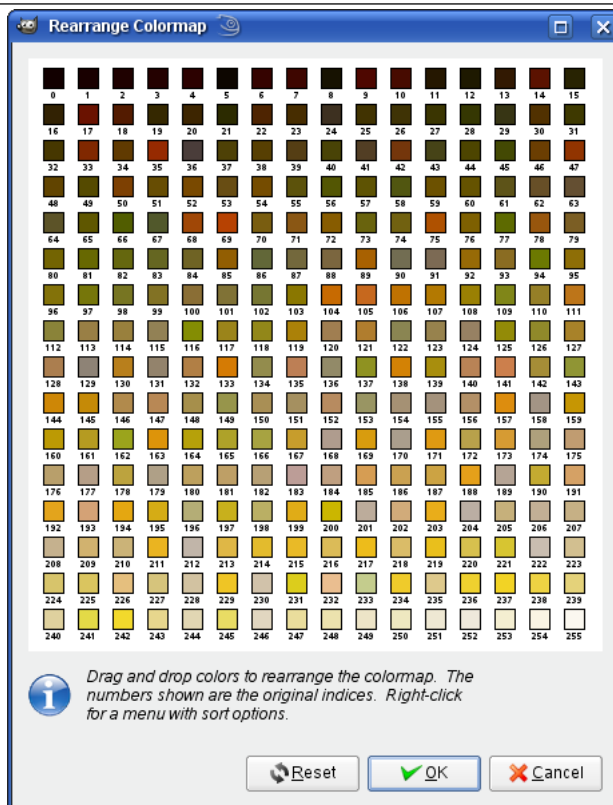


- Section 16.8.33
- Section 16.8.34
- Section 16.8.35

- Section [16.8.36](#)
- Section [16.8.37](#)
- Section [16.8.38](#)
- Section [16.8.39](#)
- Section [16.8.40](#)

16.8.33 Rearrange Colormap

Figure 16.209 The "Rearrange Colormap" window



This command allows you to re-organize colors in the palette of *indexed* images. It doesn't modify the image. You can't add or remove colors; for that, see [The Indexed Palette Dialog](#).

16.8.33.1 Activate Dialog

You can access this command from the image menu-bar through Colors → Map → Rearrange Colormap. If your image is not indexed, this command is grayed out and disabled.

16.8.33.2 Using the "Rearrange Colormap" dialog

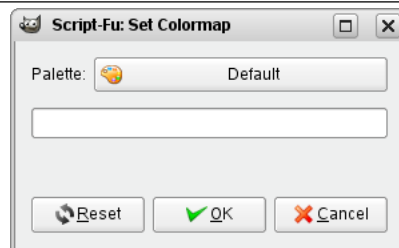
Explanations supplied in the dialog window are enough: drag and drop colors to rearrange the colormap. You can sort colors in various ways by using the local pop-menu that you get by right-clicking:

Figure 16.210 The "Rearrange Colormap" pop-menu



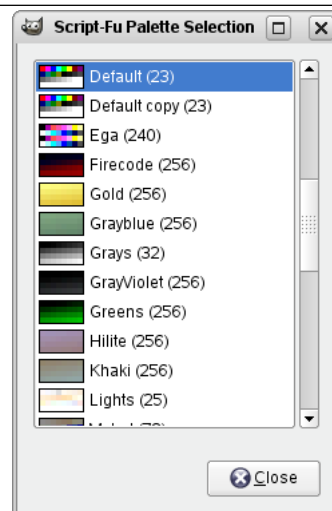
16.8.34 Set Colormap

Figure 16.211 The "Set Colormap" window



This command opens a dialog which allows you to select another palette to replace the color map of your indexed image. First click in the button with the name of the current palette (which is not the color map of your image yet) to open the Palette Selector:

Figure 16.212 The "Palette Selection" dialog



Once you have chosen the wanted palette, click the OK button in the "Set Palette" dialog to replace the image colormap.

16.8.34.1 Activate the command

This command is found in the image window menu under Colors → Map → Set Colormap.

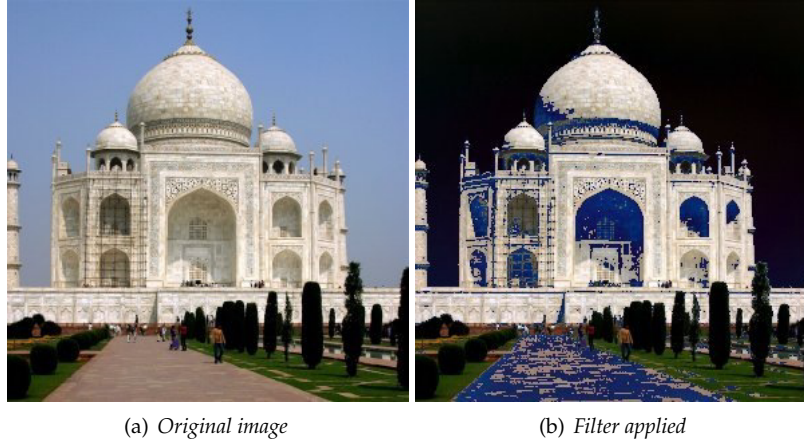
16.8.35 Alien Map

TODO

16.8.36 Color Exchange

16.8.36.1 Overview

Figure 16.213 "Color Exchange" filter example



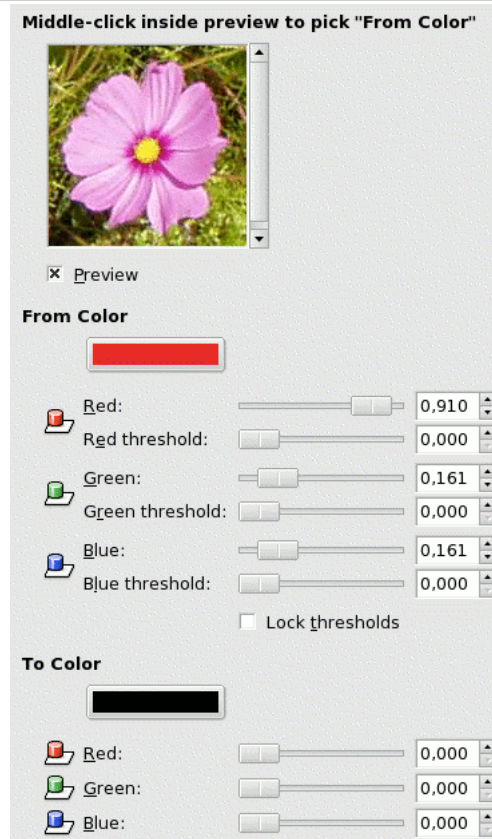
This filter replaces a color with another one.

16.8.36.2 Activate the filter

This filter is found in the image window menu under Colors → Map → Color Exchange.

16.8.36.3 Options

Figure 16.214 Option of the "Two color exchange" filter



Preview In this preview, a part of the Image is displayed. A selection smaller than preview will be complete in preview. A bigger one will be cut out to be adapted to the preview.

If you middle-click inside preview, the clicked pixel color will be selected and will appear as From Color.

From color In this section, you can choose the color to be used to select pixels that will be concerned by color exchange.

Three sliders for RVB colors: If you have clicked on preview, they are automatically positioned. But you can change them. Each slider acts on color intensity. Input boxes and arrowheads work the same. Result is interactively displayed in the From swatch box.

Three sliders for thresholds, for each color. The higher the threshold, the more pixels will be concerned. Result is interactively displayed in Preview.

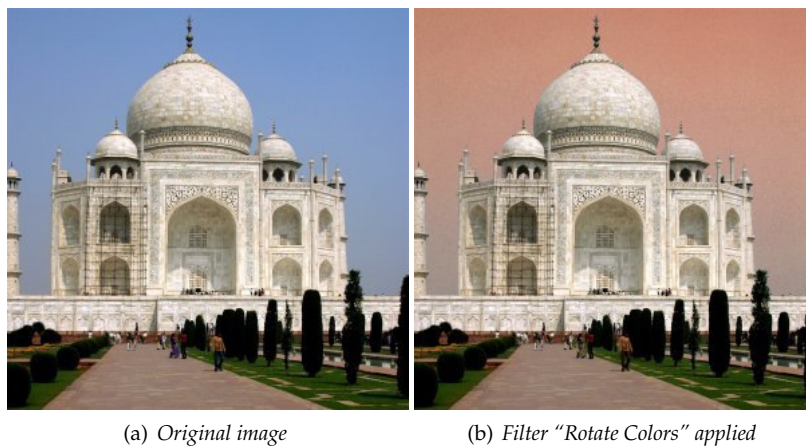
Lock Thresholds: This option locks threshold sliders which will act all the same.

To color Three cursors allow to select the color that pixels will have. Result is displayed in swatch box and in preview. You can also click on the color dwell to get a color selector.

16.8.37 Rotate Colors

16.8.37.1 Overview

Figure 16.215 Example for the "Rotate Colors" filter



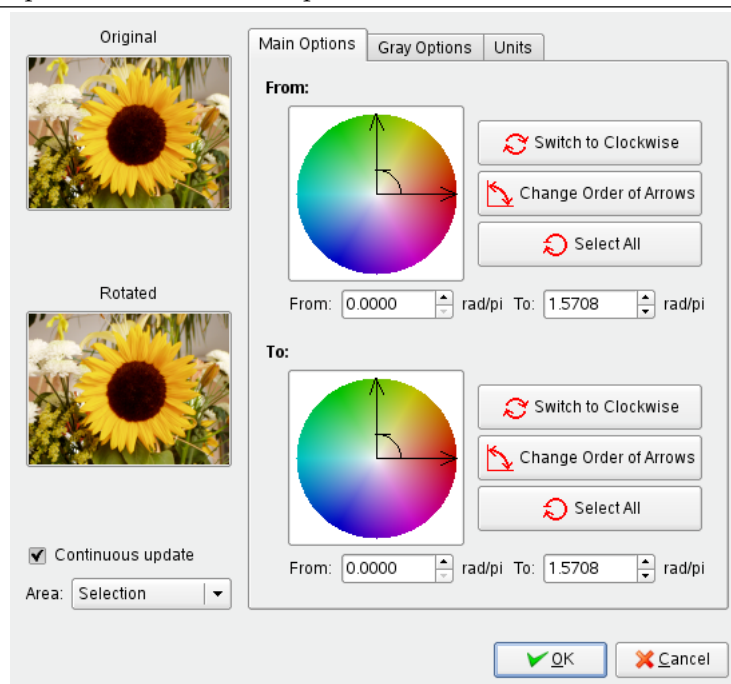
Colormap Rotation lets you exchange one color range to another range.

16.8.37.2 Activating the filter

This filter is found in the image window menu under Colors → Map → Rotate Colors.

16.8.37.3 Main Options

Figure 16.216 Main Options of the "Color Map Rotation" filter



You have there two color circles, one for the "From" color range and the other for the "To" color range:

From The Color Circle: Two axis to define "From" range. The curved arrow in angle lets to recognise "From" axis and "To" axis of range. Click-drag these axis to change range.

Switch to Clockwise/Counterclockwise: Sets the direction the range is going.

Change Order of Arrows: Inverts From and To axis. This results in an important color change as colors in selection angle are different.

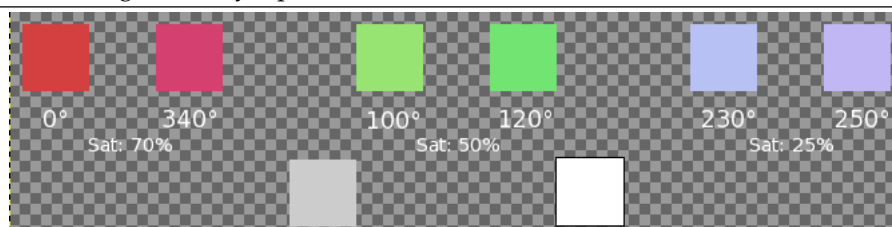
Select All selects the whole color circle.

From and To boxes display start axis and end axis positions (in rad/PI) which are limiting the selected color range. You can enter these positions manually or with help of arrow-heads.

To This section options are the same as "From" section ones.

16.8.37.4 Gray Options

Figure 16.217 Base image for Gray Options



Three sectors are defined for Red, Green and Blue with different saturations. Gray and White colors are represented (0% Sat).

In this tab, you can specify how to treat gray. By default, gray is not considered as a color and is not taken in account by the rotation. Here, you can convert slightly saturated colors into gray and you can also convert gray into color.

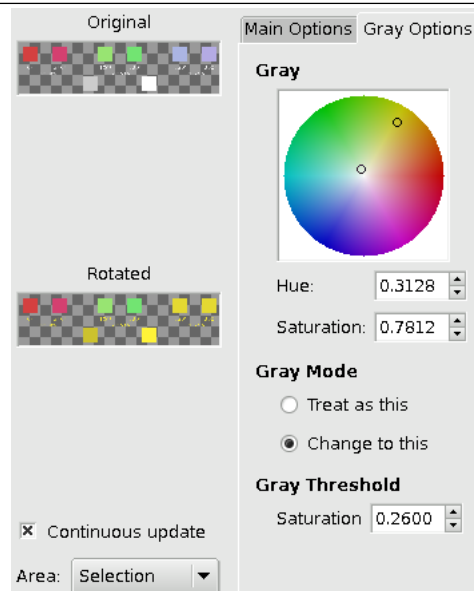
Gray Color Circle At center of this color circle is a small "define circle". At center, it represents gray. If you increase gray threshold progressively, colors with saturation less than this threshold turn to gray.

Then, if you pan the define circle in the color circle, or if you use input boxes, you define *Hue* and *Saturation*. This color will replace all colors you have defined as gray. But result depends on Gray Mode too.

Gray Mode The radio buttons *Treat As This* and *Change As This* determine how your previous choices will be treated:

- With *Change to this*, gray will take the color defined by the define circle directly, without any rotation, whatever its position in the color circle.
- With *Treat as this*, gray will take the color defined by the define circle after rotation, according to "From" and "To" choices you made in the Main tab. With this option, you can select color only in the "From" sector, even if it is not visible in Gray tab.

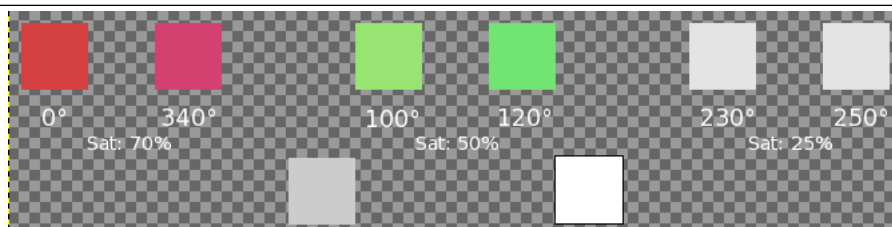
Figure 16.218 Gray Mode



The small circle is on yellow and mode is "Change to this". Blue has changed to yellow. Note that Gray and White did so too.

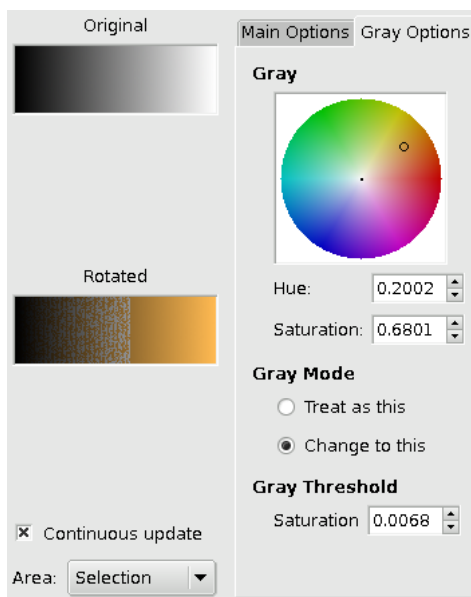
Gray Threshold

Figure 16.219 Gray Threshold



Gray-threshold is 0.25: the blue sector (sat 0.25) has turned to Gray (Note that Gray and White, that are 0% Sat., are not concerned).

You specify there how much saturation will be considered gray. By increasing progressively saturation, you will see an enlarging circle in color circle and enlarging selected areas in Preview if "Continuous update" is checked. In a black to white gradient, you can see enlarging color replacement as you increase threshold very slowly.



Black to White gradient, progressively filled with color, as threshold increases.

16.8.37.5 Previews

Original, Rotated The Original preview displays a thumbnail of the original image and the Rotated preview displays color changes interactively, before they are applied to the Image.

Continuous Update Continuous Update displays color changes continuously in the Rotated preview.

Area In this drop down list, you can select between

- Entire Layer: works on the whole layer (The image if there is no selection).
- Selection: displays selection only.
- Context: displays selection in image context.

16.8.37.6 Units

You can select here the angle unit used to locate colors in the Hue/Saturation circle. This choice is valid only for the current filter session: don't click on OK just after selecting unit, return to the wanted tab!

16.8.38 Gradient Map

16.8.38.1 Overview

Figure 16.220 Example of gradient map



Example of Gradient Mapping. Top: Original image. Middle: a gradient. Bottom: result of applying the gradient to the original image with the Gradient Map filter.

This filter uses the current gradient, as shown in the Brush/Pattern/Gradient area of the Toolbox, to recolor the active layer or selection of the image to which the filter is applied. To use it, first choose a

gradient from the **Gradients Dialog**. Then select the part of the image you want to alter, and activate the filter. The filter runs automatically, without showing any dialog or requiring any further input. It uses image color intensities (0 - 255), mapping the darkest pixels to the left end color from the gradient, and the lightest pixels to the right end color from the gradient. Intermediate values are set to the corresponding intermediate colors.

16.8.38.2 Activate the filter

You can find this filter in the image window menu under Colors → Map → Gradient Map.

16.8.39 Palette Map

16.8.39.1 Overview

This plug-in recolors the image using colors from the active palette that you choose in Dialogs → Palettes.

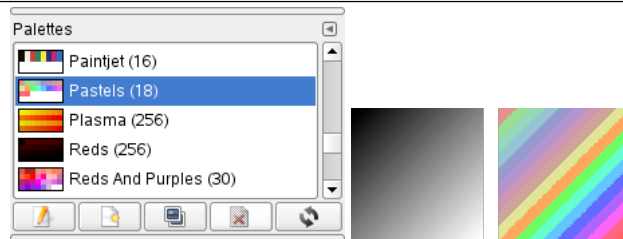
It maps the contents of the specified drawable (layer, selection...) with the active palette. It calculates luminosity of each pixel and replaces the pixel by the palette sample at the corresponding index. A complete black pixel becomes the lowest palette entry, and complete white becomes the highest. Works on both Grayscale and RGB image with/without alpha channel.

16.8.39.2 Activate the filter

You can access this filter in the image window menu under Colors → Map → Palette Map.

16.8.39.3 Example

Figure 16.221 The active palette is applied to a gradient image

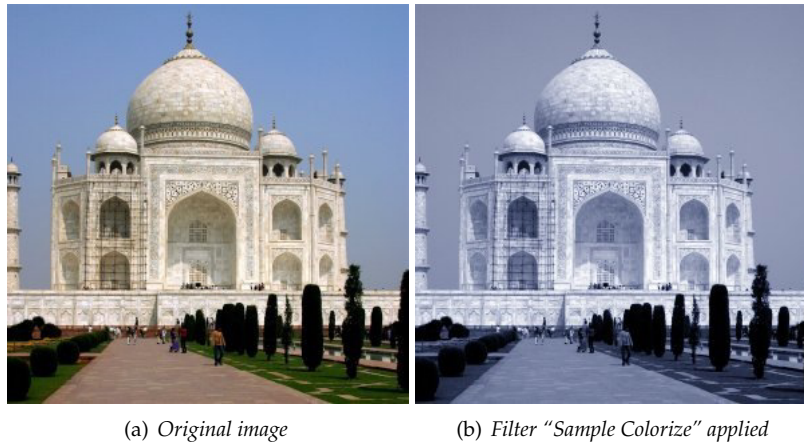


(a) The current palette, with 18 colors (b) The colors of the active palette are applied to a black to white gradient. The color with the lowest index in the palette (orange) replaces the black color in the gradient. The color with the highest index in the palette (red) replaces the white color in the gradient. The other colors spread out in the order of the palette.

16.8.40 Sample Colorize

16.8.40.1 Overview

Figure 16.222 Example for the "Sample Colorize" filter



This filter allows you to colorize old black-and-white images by mapping a color source image or a gradient against it.

Caution



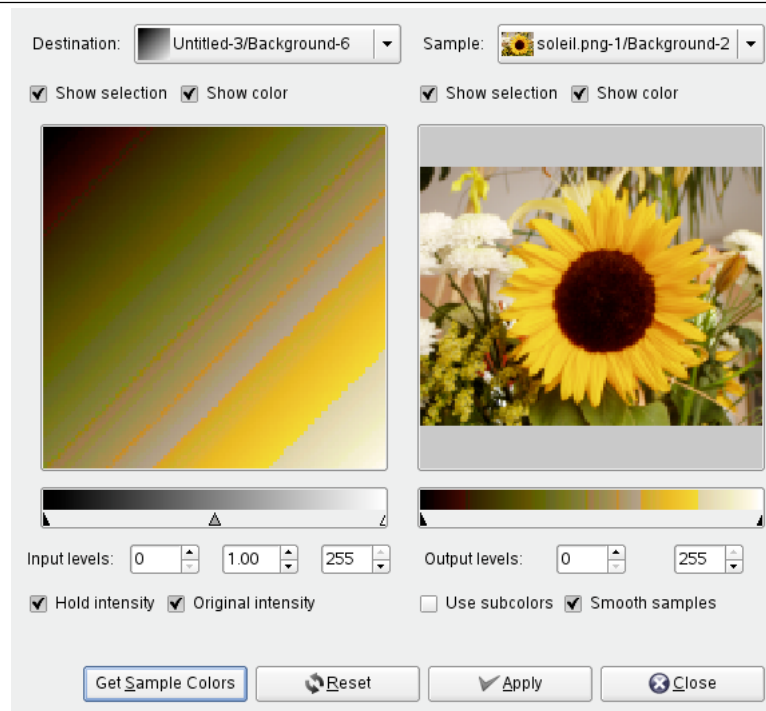
Your gray-tone image must be changed to RGB before using this filter (Image/Image>Mode>RGB).

16.8.40.2 Activate the filter

This filter is found in the image window menu under Colors → Map → Sample Colorize.

16.8.40.3 Options

Figure 16.223 Options of the "Sample Colorize" filter



The filter window is divided into two parts: Destination on the left, Sampling on the right.

Destination, Sample By default, displayed image previews reproduce the image you invoked the filter from.

The sample can be the whole preview, or a selection of this preview. With the drop list, you can select another sample-image among the names of images present on your screen when you called the filter. If you choose From Gradient (or From Inverse Gradient), the selected gradient in Gradient Dialog (or its inverse) will be the sample. It will be displayed into the gradient bar below the sample preview. The sampling preview is greyed out and two cursors allow you to select the gradient range that will be applied to the image or selection.

Destination is, by default, the source image. The drop list displays the list of images present on your screen when you evoked the filter and allow you to select another destination image. If there is a selection in this image, it will be gray-scaled, else the whole preview will be gray-scaled.

Show Selection This option toggles between the whole image and the selection, if it exists.

Show Colors This option toggles between colors and gray-scale.

Get Sample Colors When you click on this button, the gradient bar below the sample preview displays colors of the sample. If your sample holds few colors, transitions may be abrupt. Check Smooth Sample Colors option to improve them.

Use Subcolors is more difficult to understand. Let's say first that in a greyscale image there is information only for Value (luminosity, more or less light). In a RGB image, each pixel has information for the three colors and Value. So, pixels with different color may have the same Value. If this option is checked, colors will be mixed and applied to Destination pixels having that Value. If it is unchecked, then the dominating color will be applied.

Out Levels Two input boxes and two sliders act the same: they limit the color range which will be applied to destination image. You can choose this range accurately. Result appears interactively in destination preview.

In Levels Three input boxes and three sliders allow to fix importance of dark tones, mid tones and light tones. Result appears interactively in destination preview.

Hold Intensity If this option is checked, the average light intensity of destination image will be the same as that of source image.

Original Intensity If this option is checked, the In levels intensity settings will not be taken in account: original intensity will be preserved.

16.8.41 Fattal et al. 2002

TODO

16.8.42 Mantiuk 2006

TODO

16.8.43 Reinhard 2005

TODO

16.8.44 Stress

TODO

16.8.45 Retinex

16.8.45.1 Overview

Figure 16.224 "Retinex" example



(a) Original image

(b) "Retinex" filter applied. Note new details in the upper right corner.

Retinex improves visual rendering of an image when lighting conditions are not good. While our eye can see colors correctly when light is low, cameras and video cams can't manage this well. The MSR_{CR} (MultiScale Retinex with Color Restoration) algorithm, which is at the root of the Retinex filter, is inspired by the eye biological mechanisms to adapt itself to these conditions. Retinex stands for Retina + cortex.

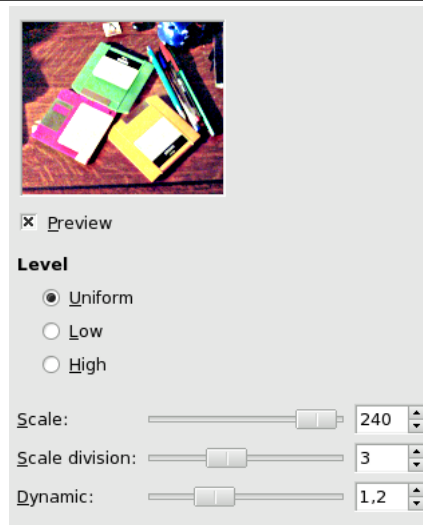
Besides digital photography, Retinex algorithm is used to make the information in astronomical photos visible and detect, in medicine, poorly visible structures in X-rays or scanners.

16.8.45.2 Activate the filter

This filter is found in the image window menu under Colors → Tone Mapping → Retinex....

16.8.45.3 Options

Figure 16.225 "Retinex" filter options



These options call for notions that only mathematicians and imagery engineers can understand. In actual practice, the user has to grope about for the best setting. However, the following explanations should help out the experimented GIMP user.

Level Here is what the plug-in author writes on his site [[PLUGIN-RETINEX](#)]: "To characterize color variations and the lighter, we make a difference between (gaussian) filters responses at different scales. These parameters allow to specify how to allocate scale values between min scale (sigma 2.0) and max (sigma equal to the image size)"...

Uniform Uniform tends to treat both low and high intensity areas fairly.

Low As a rule of thumb, low does "flare up" the lower intensity areas on the image.

High High tends to "bury" the lower intensity areas in favor of a better rendering of the clearer areas of the image.

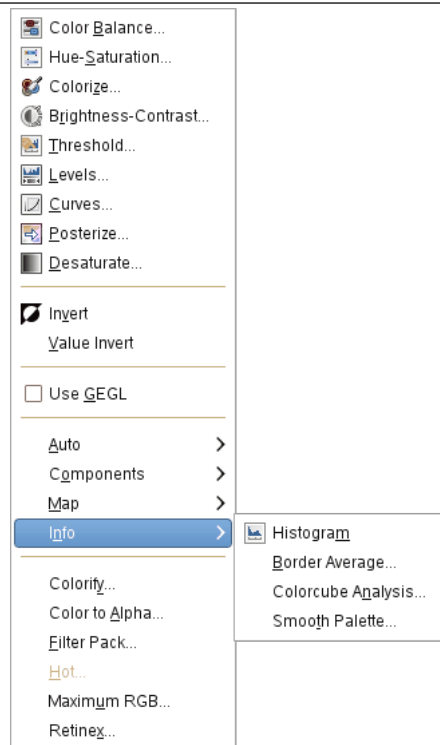
Scale Determines the depth of the Retinex scale. Minimum value is 16, a value providing gross, unrefined filtering. Maximum value is 250. Optimal and default value is 240.

Scale division Determines the number of iterations in the multiscale Retinex filter. The minimum required, and the recommended value is three. Only one or two scale divisions removes the multiscale aspect and falls back to a single scale Retinex filtering. A value that is too high tends to introduce noise in the picture.

Dynamic As the MSR algorithm tends to make the image lighter, this slider allows you to adjust color saturation contamination around the new average color. A higher value means less color saturation. This is definitely the parameter you want to tweak for optimal results, because its effect is extremely image-dependent.

16.8.46 The "Info" Submenu

This command leads to the following submenu

Figure 16.226 The “Info” submenu

- Section [16.8.47](#)
- Section [16.8.48](#)
- Section [16.8.49](#)
- Section [16.8.51](#)

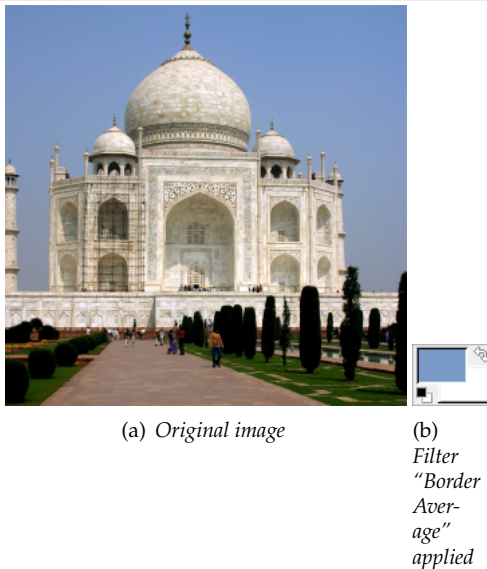
16.8.47 Histogram

The Histogram dialog is documented in Section [15.2.5](#).

16.8.48 Border Average

16.8.48.1 Overview

Figure 16.227 Example for the "Border Average" filter



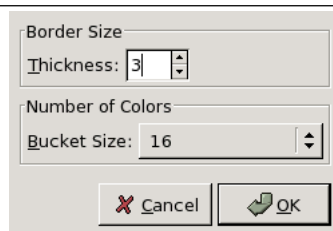
This plug-in calculates the most often used color in a specified border of the active layer or selection. It can gather similar colors together so that they become predominant. The calculated color becomes the foreground color in the Toolbox. This filter is interesting when you have to find a Web page color background that differs as little as possible from your image border. The action of this filter is not registered in Undo History and can't be deleted with Ctrl-Z : it doesn't modify the image.

16.8.48.2 Activating the filter

This filter is found in the image window menu under Colors+Info → Border Average.

16.8.48.3 Options

Figure 16.228 Options of the "Border Average Filter"

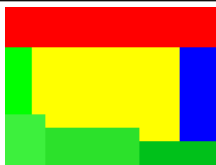


Border Size You can set there the border Thickness in pixels.

Number of Colors The Bucket Size lets you control the number of colors considered as similar and counted with the same "bucket". A low bucket size value (i.e. a high bucket number) gives you better precision in the calculation of the average color. Note that better precision does not necessarily mean better results (see example below).

16.8.48.4 Examples illustrating the "Border Average" filter

Figure 16.229 Original image



Original image: colors are pure Red (255;0;0), pure Blue (0;0;255), and different but similar kinds of Green (0;255;0 , 63;240;63 , 48;224;47 , 0;192;38).

Figure 16.230 "Number of Colors" is set to 8:



The resulting color is a Red (254,2,2).

The bucket size is low. So the bucket number is high. All color shades can be stored in different buckets. Here, the bucket containing red is the most filled. The resulting color is a nearly pure Red (254,2,2) and becomes the foreground color of the Toolbox.

Figure 16.231 "Number of Colors" is set to 64:



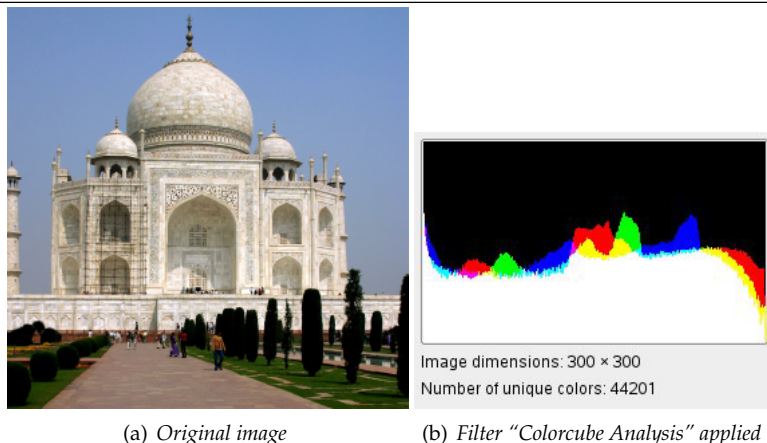
The resulting color is Green (32,224,32).

Here the bucket size is high, the number of buckets low. Similar colors (here green) are stored in a same bucket. This "green" bucket is now the most filled. All colors in this bucket have the same values for the two most significant bits: (00*****;11*****;00*****). The remaining 6 bits may have any values from 0 to 63 for the respective channel. So in this bucket, color red channels range from 0 to 63, green channels from 192 to 255, blue channels from 0 to 63. The resulting color is Green (32,224,32), which, for every channel, is the average between the limits of the channel range $(63 + 0)/2$, $(255+192)/2$, $(63+0)/2$.

16.8.49 Colorcube Analysis

16.8.49.1 Overview

Figure 16.232 Example for the "Colorcube" filter



(a) Original image

(b) Filter "Colorcube Analysis" applied

Information is reduced since GIMP 2.4: size and color number of the active layer.

16.8.49.2 Activating the filter

You can find this filter in the image window menu under Colors → Info → Colorcube Analysis.

16.8.50 Export Histogram

16.8.50.1 Overview

Exports the image histogram to a text file, so it can be used by other programs and loaded into spreadsheets. The histogram is produced for the selected image area. Fully transparent pixels are not counted.

The resulting file is a CSV file (Comma Separated Values), which can be imported directly in most spreadsheet programs. The first row of the CSV file is a title row. One data row is generated for each "Bucket". Each pixel value can be in the range of 0 to 255, and will be included in one of the buckets depending on the bucket's range.

The first column is titled "Range Start" and contains the starting value of the bucket. The following columns contain the values for different channels. Which channels will be included depends on the image type. The meaning of the values in each of the channel columns, depends on the Output Format option.

Figure 16.233 Example of file exported by "Export Histogram"

Range start,	Value,	Red,	Green,	Blue
0,	0.0,	0.0,	486.0,	0.0
1,	0.0,	0.0,	300.0,	0.0
2,	0.0,	0.0,	336.0,	0.0
3,	0.0,	0.0,	399.0,	0.0
4,	0.0,	0.0,	510.0,	0.0
....				

The example file above was generated for an RGB image, using the Pixel count output format, and a Bucket Size of 1. The row starting with the number 3 describes the fourth bucket and will include all pixels from value 3 up to (but not including) value 4. The number 399.0 in that row can then be interpreted as "There are 399 pixels that have a Green value of 3".

16.8.50.2 Activating the filter

This filter is found in the image window menu under Colors+Info → Export Histogram.

16.8.50.3 Options

Histogram File The file into which the histogram will be exported.

Bucket Size The Bucket Size lets you control the number of values considered as similar and counted in the same "bucket". A higher bucket size will produce less buckets, and thus less rows in the exported file. For example, a Bucket Size of 1 will produced 256 buckets, whereas a bucket size of 16 will produce 16 buckets.

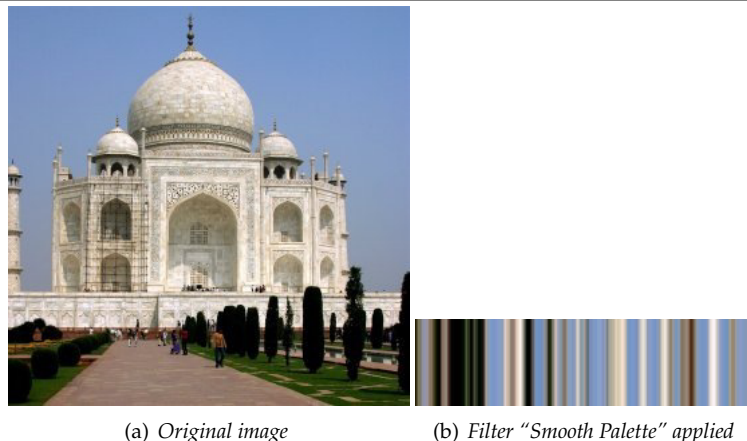
Sample Average If Sample Average is activated, the histogram will be generated for an image obtained by merging all visible layers. Otherwise, the histogram will only consider the current layer.

Output Format If the Pixel count option is chosen, the values in the generated file will reflect the amount of pixels in each bucket. If Normalized is chosen, the values will be the amount of pixels in the bucket divided by the total amount of pixels. The Percent option is similar to Normalized, but the values are formatted as percents.

16.8.51 Smooth Palette

16.8.51.1 Overview

Figure 16.234 Example for the "Smooth Palette" filter



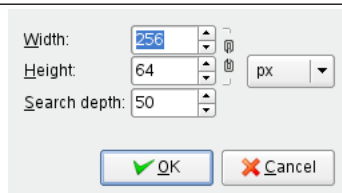
It creates a striped palette from colors in active layer or selection. The main purpose of this filter is to create color-maps to be used with the **Flame** filter.

16.8.51.2 Activating the filter

This filter is found in the image window menu under Colors → Info → Smooth Palette.

16.8.51.3 Options

Figure 16.235 "Smooth Palette" options



Parameter Settings You can set palette dimensions for Width and Height. Dimensions are linked when chain is not broken. You can also select unit.

Search Depth Increasing Search Depth (1 - 1024) will result in more shades in palette.

16.8.52 Threshold

The Threshold tool transforms the current layer or the selection into a black and white image, where white pixels represent the pixels of the image whose Value is in the threshold range, and black pixels represent pixels with Value out of the threshold range.


You can use it to enhance a black and white image (scanned text for example) or to create selection masks.

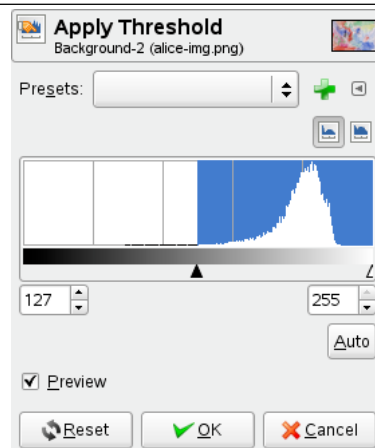
Note

As this tool creates a black and white image, the anti-aliasing of the original image disappears. If this poses a problem, use the **Levels** tool instead.

16.8.52.1 Activating the Tool

There are different possibilities to activate the tool:

- You can access this tool from the image menu through Colors → Threshold...
- or by clicking the  icon in Toolbox if this tool has been installed in it. For this, please refer to Section 12.1.11.

16.8.52.2 Options**Figure 16.236** Threshold tool options

Presets You can save the color settings of your image by clicking the Add settings to favourites button




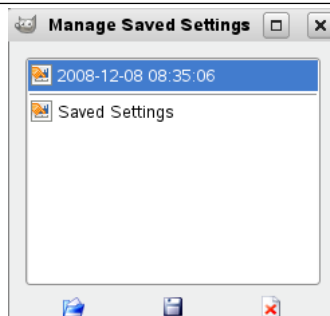
The  button opens a menu:

Figure 16.237 Preset Menu

which lets you Import Settings from File or Export Settings to File, and gives you access to the Manage Saved Presets dialog:

Figure 16.238 Manage saved Settings Dialog

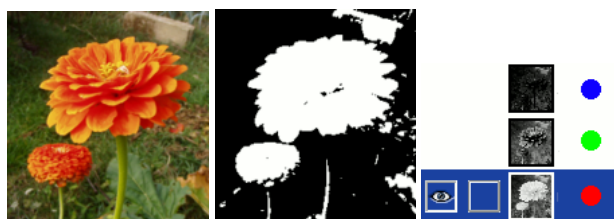
Threshold range The Threshold tool provides a visual graph, a histogram, of the intensity value of the active layer or selection. You can set the threshold range either using the input boxes or clicking button 1 and dragging on the graph. It allows you to select a part of the image with some intensity from a background with another intensity. Pixels inside the range are white, and the others are black. Adjust the range to get the selection you want in white on black background.

Preview The Preview checkbox allows dynamic updating of the active layer or selection while changes are made to the intensity level.

16.8.52.3 Using Threshold and Quick Mask to create a selection mask

That's not always the case, but an element you want to extract from an image can stand out well against the background. In this case, you can use the Threshold tool to select this element as a whole. Grogking the GIMP described a method based on a channel mask, but now, using the **Quick mask** is easier.

1. First start decomposing you image into its RGB and HSV components by using the **Decompose** filter. A new grey-scaled image is created and the components are displayed as layers in the Layer dialog. These layers come with a thumbnail but it is too small for an easy study. You can, of course, increase the size of this preview with the dialog menu (the small triangular button), but playing with the "eyes" is more simple to display the wanted layer in the decompose image. Select the layer that isolates the element the best.

Figure 16.239 The original image, the decompose image and its Layer Dialog

2. Call the Threshold tool from the decompose image. By moving the black cursor, fit threshold to isolate the best the element you want to extract. This will probably not be perfect: we will enhance the result with the selection mask we are going to create.

Warning



Make sure you have selected the right layer when you call the Threshold tool: when it is opened, you can't change to another layer.

Figure 16.240 The selected layer after threshold fit

We got the best outline for our flower. There are several red objects which we must remove.

3. Make sure the image displaying the selected layer is active and copy it to the clipboard with Ctrl-C.
4. Now, make the original image active. Click the Quick Mask button at the bottom-left corner of the image window: the image gets covered with a red (default) translucent mask. This red color does not suit well to our image with much red: go to the Channel Dialog, activate the "Quick mask" channel and change this color with the Edit Channel Attributes. Come back to the original image. Press Ctrl-V to paste the previously copied layer.

Figure 16.241 The mask

5. Voilà. Your selection mask is ready: you can improve the selection as usual. When the selection is ready, disable the Quick mask by clicking its button again : you will see the marching ants around the selection.

Figure 16.242 The result

We used the Zoom to work at a pixel level, the Lasso to remove large unwanted areas, the pencil (to get hard limits), black paint to remove selected areas, white paint to add selected areas, especially for stem.

16.8.53 Colorize

The Colorize tool renders the active layer or selection into a greyscale image seen through a colored glass. You can use it to give a "Sepia" effect to your image. See *Color model* for Hue, Saturation, Luminosity.

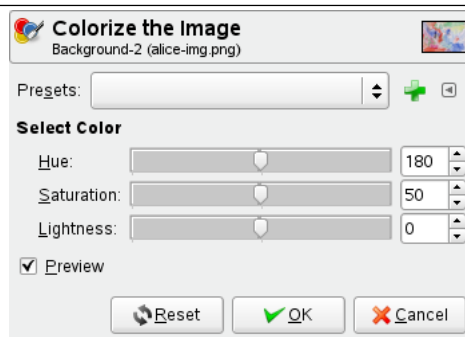
16.8.53.1 Activating tool

You can get to the Colorize tool in this way:

- In the image menu through: Colors → Colorize...

16.8.53.2 Options

Figure 16.243 Colorize options



Presets You can save the color settings of your image by clicking the Save the current settings as named

preset button 


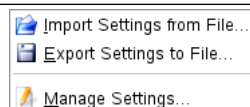
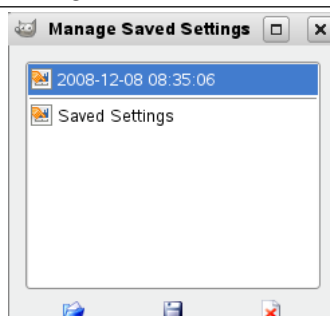
The  button opens a menu:

Figure 16.244 Preset Menu



which lets you Import Settings from File or Export Settings to File, and gives you access to the Manage Save Settings dialog:

Figure 16.245 Manage saved Settings Dialog



Color values

- Hue: The slider and the numeric input box allow you to select a hue value normalized in the range: 0.0 to 1.0.
- Saturation: The slider and the numeric input box allows you to select a saturation value normalized in the range: 0.0 to 1.0.
- Lightness: The slider and the numeric box allow you to select a lightness normalized value in the range: -1.0 (dark) to +1.0 (light).

Preview The Preview option renders all changes immediately on the canvas.

Split view This option divides the canvas in two, showing you the before and after of applying the effect on the canvas. The split can be horizontal or vertical: change between the two pressing the **Ctrl** key. The divide line can be moved by dragging it with the mouse (mouse pointer changes in a small hand when hovering on the line). Moreover, the views can be swapped using the **Shift** key.

16.8.54 Posterize

This tool is designed to intelligently weigh the pixel colors of the selection or active layer and reduce the number of colors while maintaining a semblance of the original image characteristics.

16.8.54.1 Activating the Command

You can find this command through Colors → Posterize...

16.8.54.2 Options

Figure 16.246 Posterize tool options

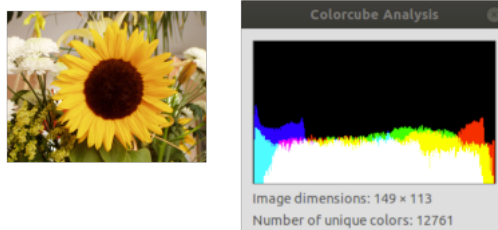


Posterize Levels Here, “level” means “number of colors per channel”.

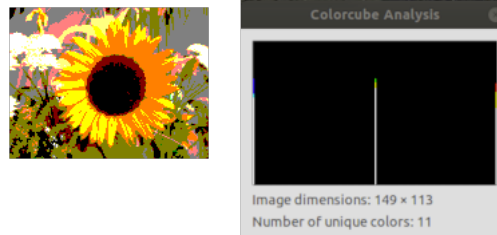
This slider and the input boxes with arrowheads allow you to set the number of levels (2-256) in each RGB channel that the tool uses to describe the active layer. The maximum total number of colors is the combination of these levels. A level to 3 will give $3^3 = 27$ colors.

Preview The Preview checkbox enables the rendering of changes right on the canvas for immediate evaluation.

16.8.54.3 Example



Original image. The Colorcube Analysis shows a great number of colors.



Original image posterized in 3 levels. The Colorcube Analysis shows 11 colors (less than the possible number 27).

16.8.55 Color to Alpha...

16.8.55.1 Overview

The Color to Alpha command makes transparent all pixels of the active layer that have a selected color. It attempts to preserve anti-aliasing information by using a partially intelligent algorithm that replaces weak color information with weak alpha information. In this way, areas that contain an element of the selected color maintain a blended appearance with their surrounding pixels.

Note



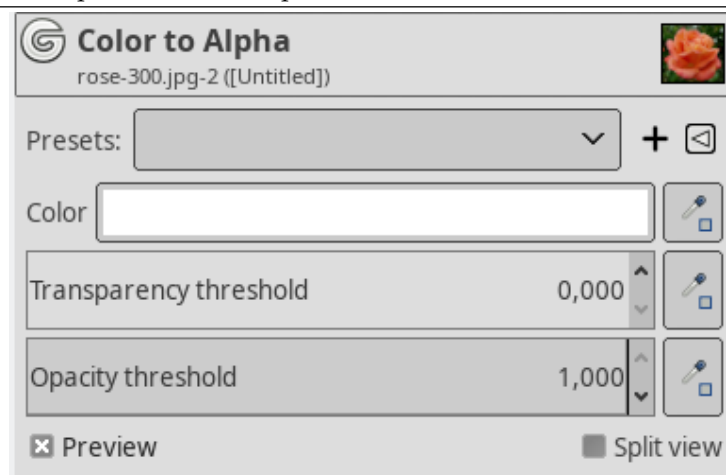
This command is usually grayed out : you must **add an alpha channel** to use the command.

16.8.55.2 Activate the filter

This filter is found in the image window menu under Colors → Color to Alpha....

16.8.55.3 Options

Figure 16.247 “Color to Alpha” command options



Presets, Preview, Split view These options are common to GEGL-based filters. Please refer to Section 17.2.

Color Clicking the color swatch provides a color selection dialog where you can select a color. You can also select a color using the eye dropper on the right.

“Color to alpha” comes with a GEGL option dialog under Toolbox. When the Sample average option is unchecked, color picker picks only one pixel color. When the option is checked, mouse

pointer goes with a square limiting a pixel sample that determines a merged sample "color". You can fix square size directly in text box, or using arrow heads, or **Up** and **Down** keyboard keys.

Right clicking the color swatch displays a menu where you can select Foreground or Background colors, White or Black.

Transparency and Opacity thresholds

- Transparency: the limit below which colors become transparent.
- Opacity: the limit above which colors become opaque.

Color to Alpha modifies the transparency (and color) of the pixels based on their distance from the selected background color (the "Color" option) -- the closer they are to the background color, the more transparent they become, with the background color becoming fully transparent.

The transparency and opacity thresholds control how close colors should be to the background color before they become fully transparent, and how far they should be from the background color before they remain fully opaque, respectively. With the default values of 0 and 1, only the background color becomes fully transparent, and only the colors farthest away from the background color remain fully opaque.

For example, while the default values work well for removing a white background from a black object, if the object is gray instead [fig. 1] it will become semi-transparent [fig. 2], since gray is midway between white and black. Lowering the opacity threshold to 0.5 fixes that, by keeping all pixels that are gray or darker (all pixels whose distance from white is 0.5 or more, on a [0,1] scale) fully opaque [fig. 3].

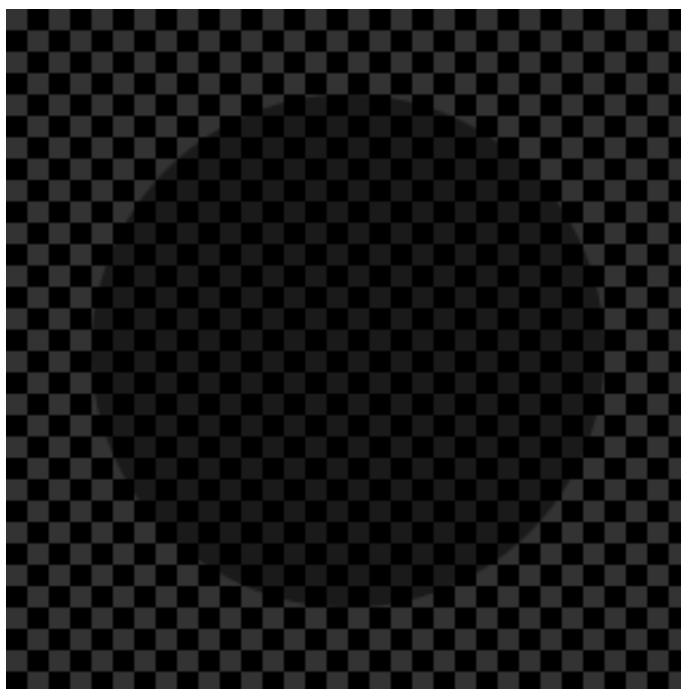
The transparency threshold works similarly: raising it causes more colors in the neighborhood of the background color to become fully transparent. This is mostly useful with noisy images, in which the background is not fully solid. However, unlike in other cases, when the transparency threshold is above 0, recomposing the result against the background color no longer reproduces the exact same image.

At the risk of being a bit technical, this can be visualized by thinking of the RGB cube. The background color is a point within the cube, and the transparency and opacity thresholds are two sub-cubes centered around the background color. Everything inside the transparency-threshold cube becomes fully transparent, everything outside the opacity-threshold cube remains fully opaque, and everything in between gradually transitions from transparent to opaque. In image [fig. 4] you can see the Red-Green face of the RGB cube. (1) is the background color (Red=0.5, Green=0.5, Blue=0.0), (2) is the transparency threshold (set to 0.1), and (3) is the opacity threshold (set to 0.4).

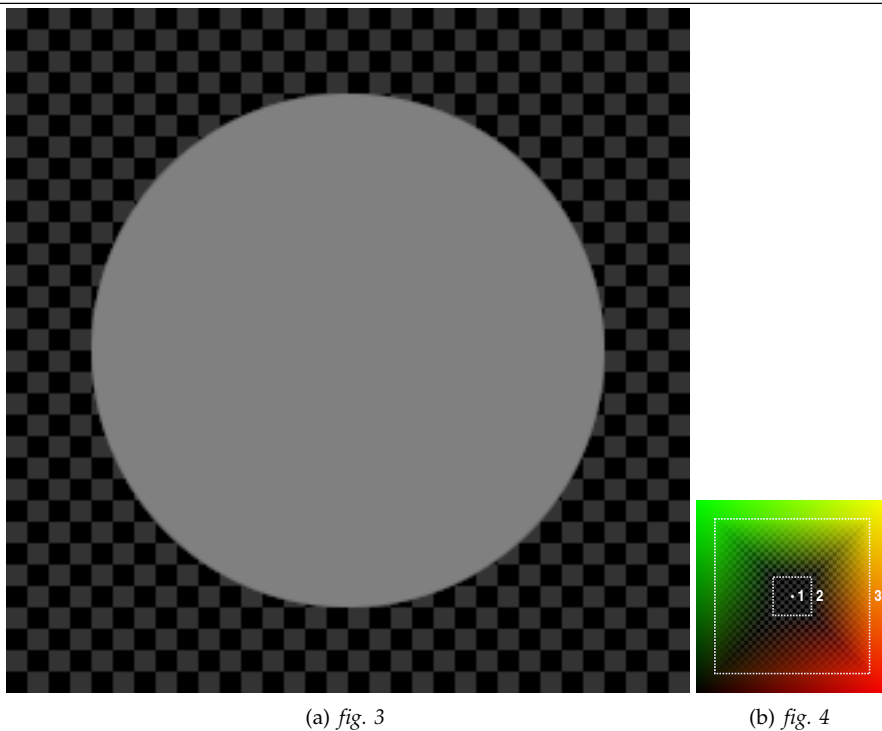
Figure 16.248 Color to Alpha Thresholds examples



(a) *fig. 1*



(b) *fig. 2*

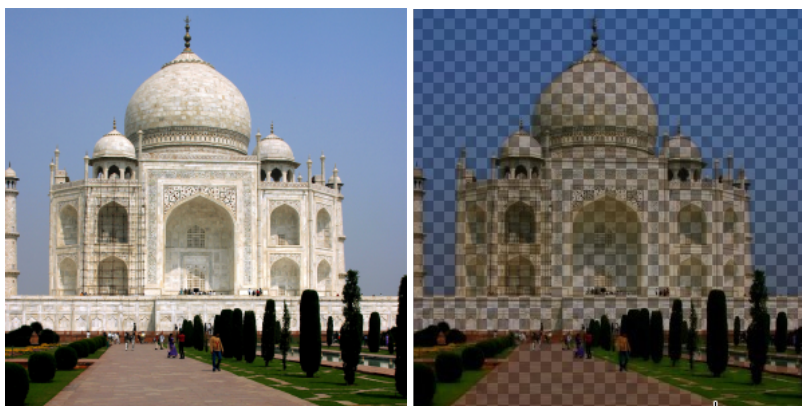
Figure 16.249 Color to Alpha Thresholds examples

(a) fig. 3

(b) fig. 4

16.8.55.4 Using Color to Alpha

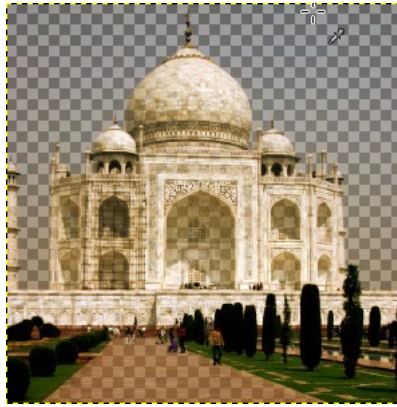
1. Add an alpha channel to your image if necessary (Layer > Transparency > Add Alpha Channel).
2. Open Color to alpha.

Figure 16.250 Color to alpha open with default options

(a) Original image with alpha channel

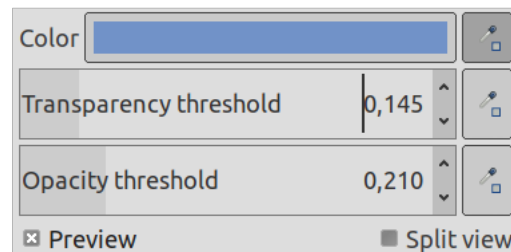
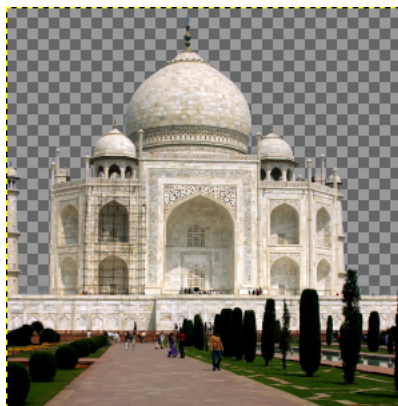
(b) Original image with an alpha channel. Color to alpha with default options : "Color" is white. Opacity threshold = 1.00 is maximum, and so only the colors farthest away from the "Color" remain fully opaque. Transparency threshold = 0 and so the "Color" is fully transparent.

3. Uncheck Preview option.
4. Pick color, here the sky.
5. Re-check Preview option.



"Color" from sky. Default thresholds.

6. Adapt Transparency and Opacity thresholds proceeding by trial and error.



Only sky is transparent. Opacity threshold decreased to make farthest colors (monument,trees and road) fully opaque. Transparency threshold increased to make "Color" fully transparent and delete some imperfections in sky.

16.8.56 Dither

TODO

16.8.57 RGB Clip

TODO

16.8.58 Hot...

16.8.58.1 Overview

This command identifies and modifies pixels which might cause problem when displayed onto PAL or NTSC TV screen.

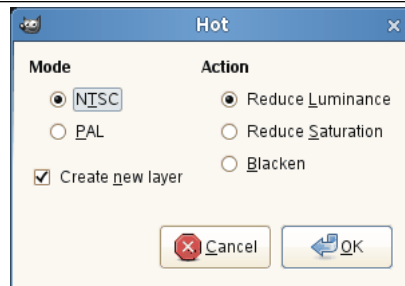
16.8.58.2 Activate the command

You can access the command from the image menu bar through Colors → Hot....

This command only works on images in RGB mode, and only if the active layer does not have an alpha channel. Otherwise the command is disabled.

16.8.58.3 Options

Figure 16.251 “Hot” options



Mode You have to select the TV mode: PAL or NTSC.

Action You can select:

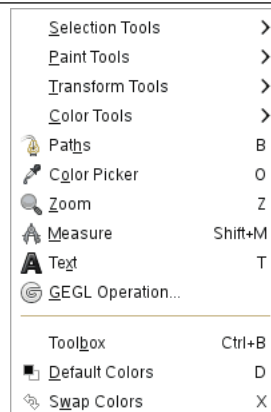
- Reduce Luminency
- Reduce Saturation
- Blacken: this changes hot pixels to black.

Create a new layer With this option, work is performed on a new layer instead of the active layer. This will give you peace of mind!

16.9 The “Tools” Menu

16.9.1 Introduction to the “Tools” Menu

Figure 16.252 Contents of the “Tools” menu

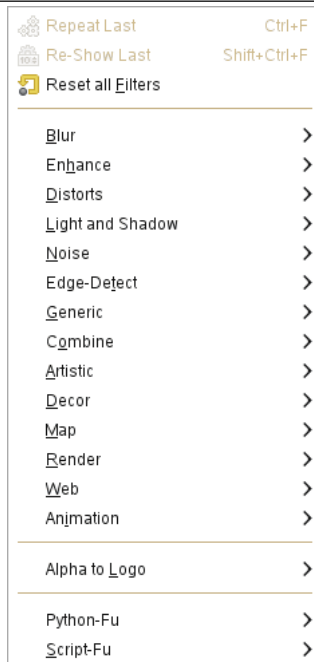


The menu entries on the Tools menu access the GIMP tools. All of the tools available in GIMP are extensively described in the [Tools](#) section.

16.10 The “Filters” Menu

16.10.1 Introduction to the “Filters” Menu

Figure 16.253 The “Filters” menu



In GIMP terminology, a *filter* is a plug-in that modifies the appearance of an image, in most cases just the active layer of the image. Not all of the entries in this menu meet that definition, however; the word “filter” is often mis-used to mean any plug-in, regardless of what it does. Indeed, some of the entries in this menu do not modify images at all.

With the exception of the top three items of the Filters menu, all of the entries are provided by plug-ins. Each plug-in decides for itself where it would like its menu entry to be placed. Therefore, the appearance of this menu can be completely different for each user. In practice, though, the appearance does not vary very much, because most plug-ins come with GIMP when it is installed, and of course they are always in the same places in the menu.

Plug-ins are not restricted to just the Filters menu: a plug-in can place entries in any menu. Indeed, a number of GIMP’s basic functions (for example, Semi-flatten in the Layer menu) are implemented by plug-ins. But the Filters menu is the default place for a plug-in to place its menu entries.

For general information on plug-ins and how to use them, see the section on [Plug-ins](#). You can find information on the filters that are provided with GIMP in the [Filters](#) chapter. For filters you install yourself, please refer to the information which came with them.

16.10.2 Repeat Last

The Repeat Last command performs the action of the most recently executed plug-in again, using the same settings as the last time it was run. It does not show a dialog or request confirmation.

Note



Please note that this command repeats the most recently executed *plug-in*, regardless of whether it is in the Filters menu or not.

16.10.2.1 Activating the Command

- You can access this command from the image menubar through Filters → Repeat *filter*,
- or by using the keyboard shortcut Ctrl-F.

16.10.3 Re-show Last

The Re-show Last command shows the dialog of the most recently executed plug-in. Unlike the “Repeat Last” command, which does not display a dialog, the “Re-show Last” command displays a dialog window, if the plug-in has one. It is displayed with the settings you used the last time you ran the plug-in (assuming that the plug-in follows the GIMP programming conventions).

Note



Please note that this command repeats the most recently executed *plug-in*, regardless of whether it is in the Filters menu or not.

Tip



When you are using a plug-in, especially one that does not have a preview window, you may very well have to adjust the parameters several times before you are satisfied with the results. To do this most efficiently, you should memorize the shortcuts for Undo and Re-show Last: Ctrl-Z followed by Ctrl-Shift-F.

16.10.3.1 Activating the Command

- You can access this command from the image menubar through Filters → Re-show *filter*,
- or by using the keyboard shortcut Ctrl-Shift-F.

16.10.4 Reset All Filters

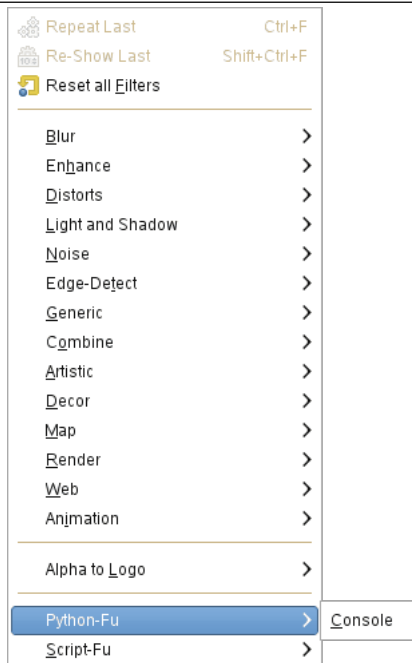
Normally, each time you run an interactive plug-in, its dialog is displayed with all of the settings initialized to the ones you used the last time you ran it. This may be a problem if you made a mistake setting the values and you can't remember what they were originally. One way to recover is to exit GIMP and start again, but the Reset all Filters command is a slightly less drastic solution: it resets the values for *all* plug-ins to their defaults. Because it is a dramatic step, it asks you to confirm that you really want to do it. Be careful: you cannot undo this command.

16.10.4.1 Activating the Command

- You can access this command from the image menubar through Filters → Reset all Filters.

16.10.5 The “Python-Fu” Submenu

Figure 16.254 The “Python-Fu” submenu



By default this submenu just contains the Python-Fu console.

Python-Fu is a set of **Python** modules that act as a wrapper to *libgimp* allowing the writing of plug-ins for GIMP.

16.10.5.1 Activating the submenu

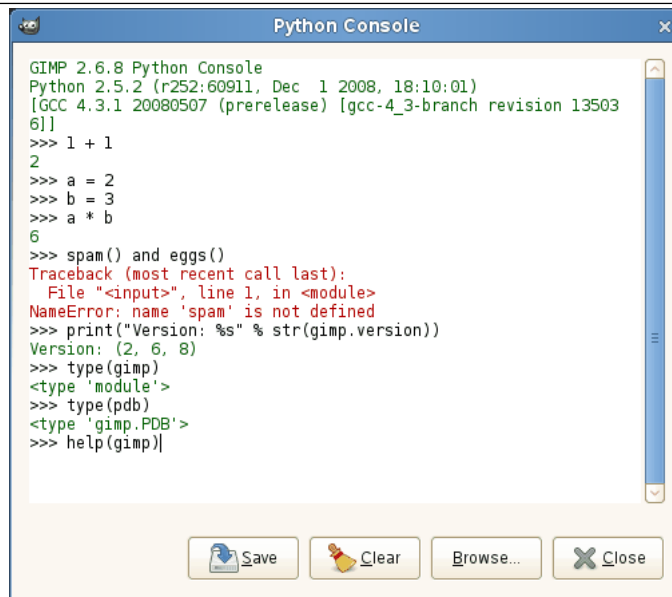
- You can access this command from the image menu through Filters → Python-Fu

16.10.5.2 The Python-Fu Console

The Python-Fu console is a dialog window running a “Python shell” (a Python interpreter in interactive mode). This console is set up to make use of the internal GIMP library routines of *libgimp*.

You can use the Python-Fu console to interactively test Python commands.

The console consists of a large scrollable main window for input and output, where you can type Python commands. When you type in a Python command and then press the **Enter** key, the command is executed by the Python interpreter. The command’s output as well as its return value (and its error message, if any) will be displayed in the main window.

Figure 16.255 The Python-Fu Console

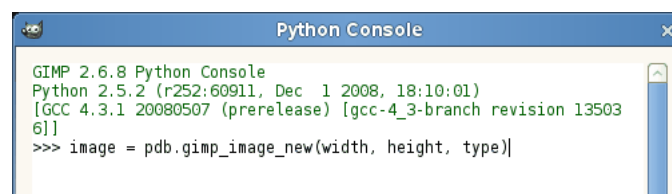
The Python-Fu Console Buttons

Save This command lets you save the content of the main window, that is the Python-Fu console input and output (including the “>>>” prompt).

Clear When you click on this button, the content of the main window will be removed. Note that you can’t get back the removed content using the Save command.

Browse When clicked, the **procedure browser** pops up, with an additional button Apply at the bottom of the window.

When you press this Apply button in the procedure browser, a call to the selected procedure will be pasted into the console window as a Python command:



Applied PDB procedure

Now you just have to replace the parameter names (here: “width”, “height”, and “type”) with actual values, e.g.

```
image = pdb.gimp_image_new(400, 300, RGB)
```

Then press **Enter** to execute the command.

You can (and should!) use the constants you find in the description of the procedure’s parameters, for example “RGB-IMAGE” or “OVERLAY-MODE”. But note that you have to replace hyphens (“-”) with underscores (“_”): RGB_IMAGE, OVERLAY_MODE.

Tip

Python-Fu is not limited to just calling procedures from the **PDB** (GIMP procedural database). To create a new image object like in the example above, you can also type

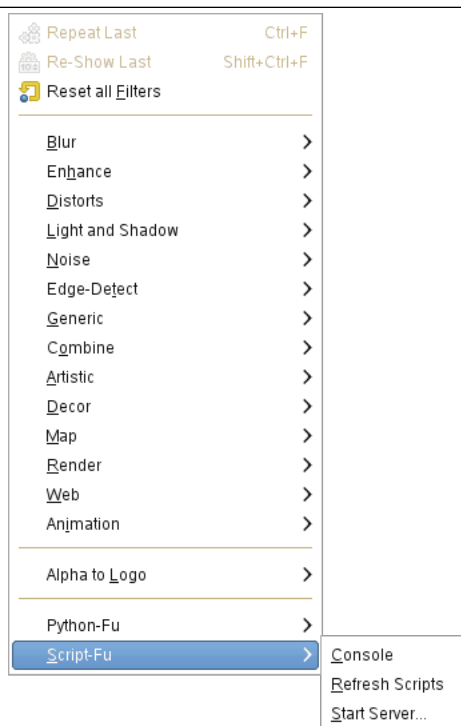
```
image = gimp.Image(width, height, type)
```

(with actual values for “width”, “height”, and “type”).

Close Pressing this button closes the console.

16.10.6 The “Script-Fu” Submenu

Figure 16.256 The “Script-Fu” submenu



This submenu contains some Script-Fu commands, especially the Script-Fu console. **Script-Fu** is a language for writing scripts, which allow you to run a series of GIMP commands automatically.

16.10.6.1 Activating the submenu

- You can access this command from the image menu through Filters → Script-Fu

16.10.6.2 Refresh Scripts

You will need this command every time you add, remove, or change a Script-Fu script. The command causes the Script-Fus to be reloaded and the menus containing Script-Fus to be rebuilt from scratch. If you don’t use this command, GIMP won’t notice your changes until you start it again.

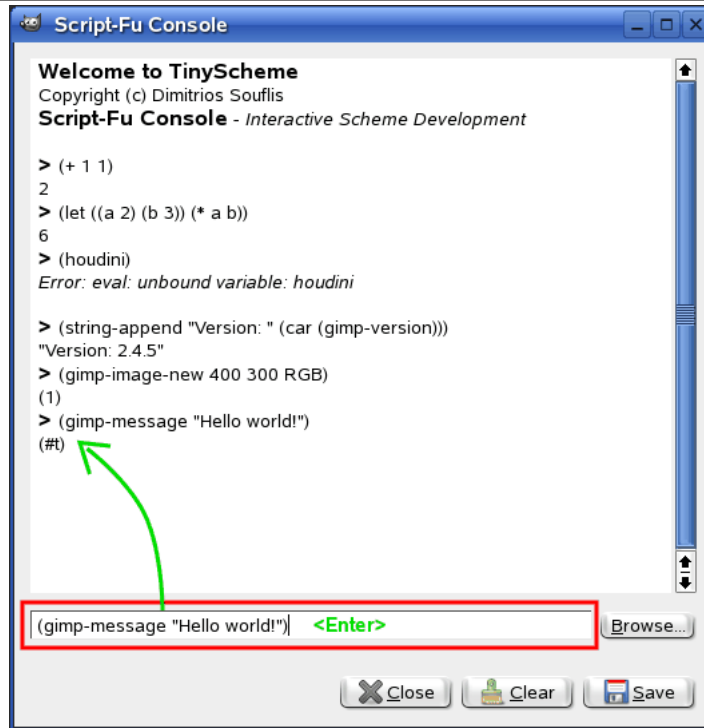
Note that you won’t get any feedback, unless saving, if one of your scripts fails.

16.10.6.3 Script-Fu Console

The Script-Fu console is a dialog window where you can interactively test Scheme commands.

The console consists of a large scrollable main window for output and a textbox used to type Scheme commands. When you type a Scheme statement and then press the **Enter** key, the command and its return value will be displayed in the main window.

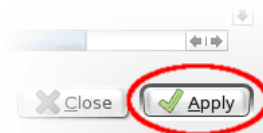
Figure 16.257 The Script-Fu Console



You will find more information about **Scheme** and examples how to use the **Script-Fu console** in Section 13.3.

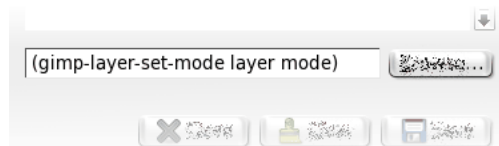
The Script-Fu Console Buttons

Browse This button is next to the Scheme commands textbox. When clicked, the **procedure browser** pops up, with an additional button at the bottom of the window:



The additional button of the Procedure Browser

When you press this Apply button in the procedure browser, the selected procedure will be pasted into the text box:



Applied PDB procedure

Now you just have to replace the parameter names (here: "layer" and "mode") with actual values, and then you can call the procedure by pressing **Enter**.

Close Pressing this button closes the Script-Fu console.

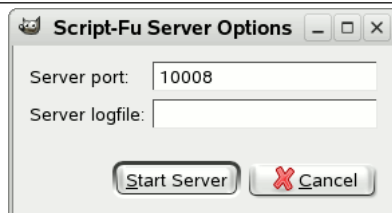
Clear When you click on this button, the content of the main window will be removed. Note that you can't get back the removed content using the Save command.

Save This command lets you save the content of the main window, that is the Script-Fu console output (including the ">"-characters).

16.10.6.4 Start Server

This command will start a server, which reads and executes Script-Fu (Scheme) statements you send him via a specified port.

Figure 16.258 The Script-Fu Server Options



Server Port The port number where the Script-Fu server will listen. It is possible to start more than one server, specifying different port numbers, of course.

Server Logfile Optionally you can specify the name of a file the server will use to log informal and error messages. If no file is specified, messages will be written to stdout.

The Script-Fu Server Protocol

The protocol used to communicate with the Script-Fu server is very simple:

- Every message (Script-Fu statement) of length L sent to the server has to be preceded with the following 3 bytes:

Table 16.1 Header format for commands

Byte #	Content	Description
0	0x47	Magic byte ('G')
1	$L \text{ div } 256$	High byte of L
2	$L \text{ mod } 256$	Low byte of L

- Every response from the server (return value or error message) of length L will be preceded with the following 4 bytes:

Table 16.2 Header format for responses

Byte #	Content	Description
0	0x47	Magic byte ('G')
1	error code	0 on success, 1 on error
2	$L \text{ div } 256$	High byte of L
3	$L \text{ mod } 256$	Low byte of L

Tip



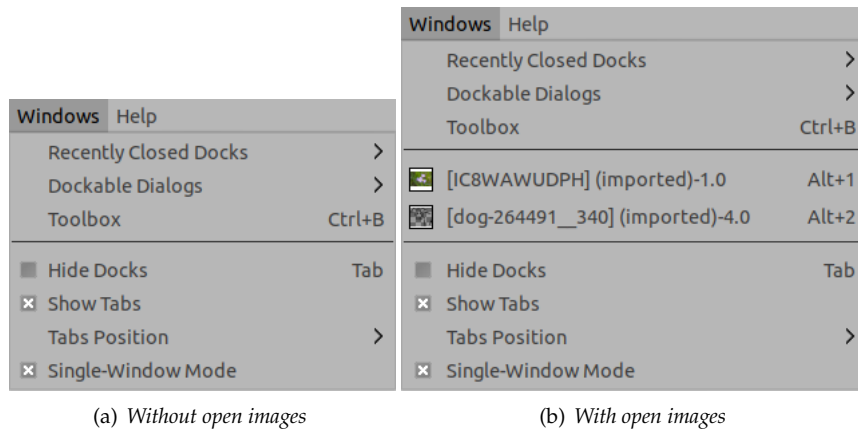
If you don't want to get your hands dirty: there is a Python script named `servertest.py` shipped with the GIMP source code, which you can use as a simple command line shell for the Script-Fu server.

16.11 "Windows" Menu

This menu allows you to manage GIMP windows dialogs:

The “Windows” menu name is not well adapted to the new single-window mode. Nevertheless, its functions concern multi and single modes. Its display may vary according presence or absence of images and docks:

Figure 16.259 Contents of the “Windows” Menu

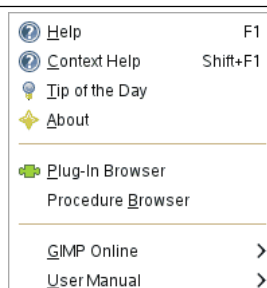


1. **Recently Closed Docks:** this command opens the list of the docks you have closed recently. You can reopen them by clicking on their name. Please note that isolated windows are not concerned. For more information about docks, please see [Dialogs and Docking](#).
2. **Dockable Dialogs:** this command opens the list of dockable dialogs. Please refer to Section [3.2.3](#).
3. **Toolbox:** clicking on this command or using the Ctrl-B shortcut, raises the toolbox usually together with the tool options dock. Note that in single-window mode this usually doesn't have any effect since the toolbox is part of the main window.
4. The list of open image windows: clicking on an image name, or using the Alt-Number of the image shortcut, makes the image active.
5. The list of open docks: in this list, docks are named with the name of the active dialog in this dock. Clicking on a dock name raises this dock. Note that in single-window mode only docks that are not part of the main window will be shown here.
6. **Hide Docks (Tab):** this command hides all docks (usually to the left and right of the image), leaving the image window alone. The command status is kept on quitting GIMP and will be in the same state when GIMP starts.
7. **Single Window Mode:** when enabled, GIMP is in a single window mode. Please see [Single Window Mode](#).

16.12 The “Help” Menu

16.12.1 Introduction to the “Help” Menu

Figure 16.260 Contents of the “Help” menu



The Help menu contains commands that assist you while you are working with GIMP.

Note



Besides the commands described here, you may also find other entries in the menu. They are not part of GIMP itself, but have been added by extensions (plug-ins). You can find information about the functionality of a Plugin by referring to its documentation.

16.12.2 Help

The Help command displays the GIMP Users Manual in a browser. You can set the browser you would like to use in the Help System section of the Preferences dialog, as described in Section 12.1.13. The browser may be the built-in GIMP help browser, or it may be a web browser.

Tip



If the help does not seem to work, please verify that the “GIMP Users Manual” is installed on your system. You can find the most recent help online [[GIMP-DOCS](#)].

16.12.2.1 Activating the Command

- You can access this command from the image menubar through Help → Help (F1).

16.12.3 Context Help

The Context Help command makes the mouse pointer context-sensitive and changes its shape to a “?”. You can then click on a window, dialog or menu entry and GIMP displays help about it, if it is available. You can also access context help at any time by pressing the F1 key while the mouse pointer is over the object you would like help about.

16.12.3.1 Activating the Command

- You can access this command from the image menu through Help → Context Help
- or by using the keyboard shortcut Shift-F1.

16.12.4 Tip of the Day

The Tip of the Day command displays the Tip of the Day dialog. This dialog contains useful tips to help you gain a better understanding of some of the subtle points of using GIMP. New users will find it very valuable to pay attention to these, because they often suggest ways of doing something that are much easier or more efficient than more obvious approaches.

16.12.4.1 Activating the Command

- You can access this command in the image menu through Help → Tip of the Day.


16.12.4.2 Description of the dialog window

Figure 16.261 “Tip of the Day” Dialog window



Some tips contain a Learn more link to the corresponding GIMP manual page.

New in GIMP 2.6

 The tip of the day is no longer displayed by default each time you start GIMP.

16.12.5 About

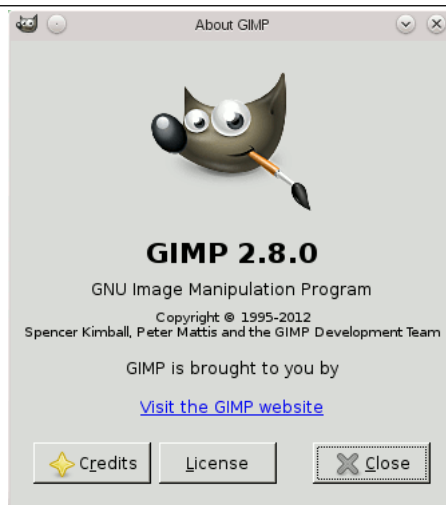
The About command shows the About window, which displays information about the version of The GIMP you are running and the many authors who wrote it.

16.12.5.1 Activating the “About” Command

- You can access this command in the image menu through Help → About

16.12.5.2 Description of the dialog window

Figure 16.262 The “About” dialog window



The Credits leads to the list of contributors to GIMP program, concerning programming, graphics and translation of the interface.

The Licence explains how to get the licence.

16.12.6 Plug-In Browser

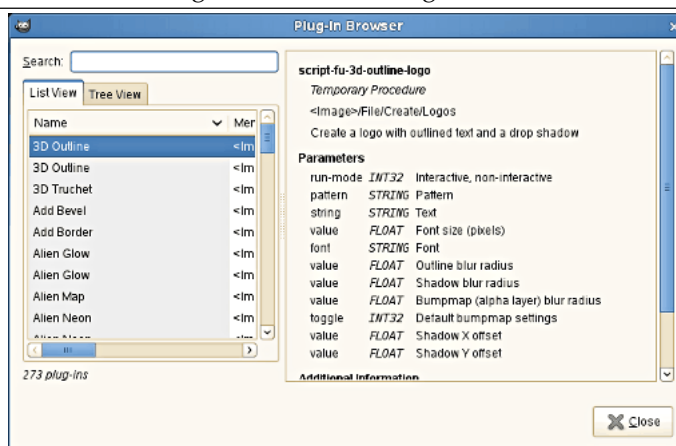
The Plug-In Browser command displays a dialog window which shows all of the extensions (plug-ins) which are currently loaded in GIMP, both as a list and as a hierarchical tree structure. Since many of the filters are actually plug-ins, you will certainly see many familiar names here. Please note that you do not run the extensions from this dialog window. Use the appropriate menu entry to do that instead. For example, you can run filter plug-ins by using the Filter command on the image menubar.

16.12.6.1 Activating the Command

- You can access this command from the image menubar through Help → Plug-in Browser

16.12.6.2 Description of the "Plug-In Browser" dialog window

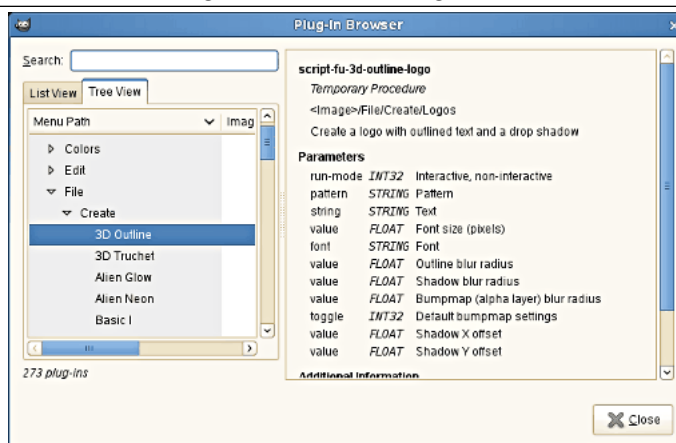
Figure 16.263 The list view of the "Plug-In Browser" dialog window



The figure above shows the list view of the Plug-In Browser. You can click on the name of a plug-in in the scrolled window to display more information about it. Select the List View by clicking on the tab at the top of the dialog.

You can search for a plug-in by name by entering part or all of the name in the Search: text box. The left part of the dialog then displays the matches found.

Figure 16.264 The tree view of the "Plug-In Browser" dialog window



The figure above shows the tree view of the Plug-In Browser. You can click on the name of a plug-in in the scrolled window to display more information about it. You can click on the arrowheads to expand or contract parts of the tree. Select the Tree View by clicking on the tab at the top of the dialog.

You can search for a plug-in by name by entering part or all of the name in the Search: text box. The left part of the dialog then displays the matches found.

Note

Not everything in these huge dialog windows is visible at the same time. Use the scroll bars to view their content.

16.12.7 The Procedure Browser

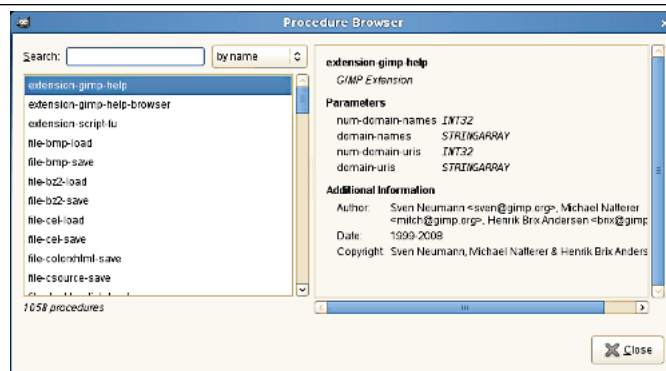
The Procedure Browser command displays the procedures in the **PDB**, the Procedure Database. These procedures are functions which are called by the scripts or plug-ins.

16.12.7.1 Activating the Command

- You can access this command from the image menubar through Help → Procedure Browser

16.12.7.2 Description of the "Procedure Browser" dialog window

Figure 16.265 The "Procedure Browser" dialog window



The figure above shows the Procedure Browser dialog window. If you click on an item in the scrolled list on the left, information about it is displayed on the right. You can also search for a specific procedure by querying the procedural database with a regular expression on Search: text box:

by name Shows a list of procedures which have code names that contain the part of name you entered.

by description Shows a list of procedures which have blurbs that contain the word you entered.

by help Shows a list of procedures which have additional information text that contain the word you entered.

by author Shows a list of procedures which created by the author which has the part of name you entered.

by copyright Shows a list of procedures which copyright are hold by someone that have the part of name you entered.

by date Shows a list of procedures which have date of year that match the year you entered.

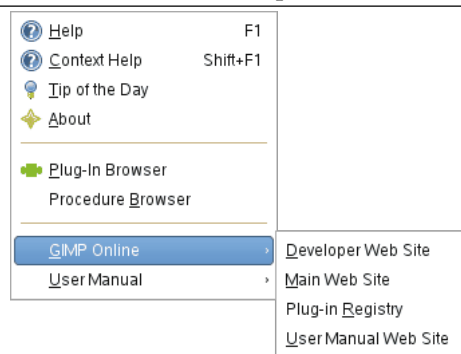
Note

This query is processed with text but not date value, so you cannot find some procedure entries even if their date contains the year you entered. For example, a procedure dated 2000-2005 does not match if you search procedures with 2001, but it matches with 2000 or 2005.

by type Shows a list of procedures which have a one of four types: "Internal GIMP procedure", "GIMP Plug-In", "GIMP Extension", or "Temporary Procedure".

16.12.8 GIMP online

Figure 16.266 The "GIMP Online" submenu of the Help menu



The GIMP online command displays a submenu which lists several helpful web sites that have to do with various aspects of GIMP. You can click on one of the menu items and your web browser will try to connect to the URL.

Chapter 17

Filters

17.1 Introduction

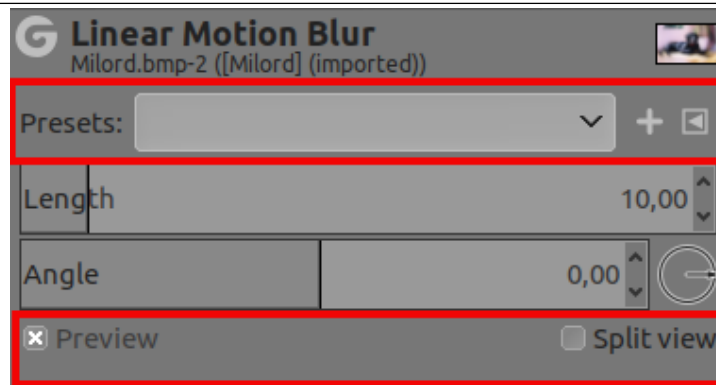
A filter is a special kind of tool designed to take an input layer or image, apply a mathematical algorithm to it, and return the input layer or image in a modified format. GIMP uses filters to achieve a variety of effects and those effects are discussed here.

The filters are divided into several categories:



- Section [17.3](#)
- Section [17.4](#)
- Section [17.5](#)
- Section [17.6](#)
- Section [17.7](#)
- Section [17.8](#)
- Section [17.9](#)
- Section [17.10](#)
- Section [17.11](#)
- Section [17.12](#)
- Section [17.13](#)
- Section [17.14](#)
- Section [17.15](#)
- Section [17.16](#)

17.2 Common Features

With GIMP-2.10, GEGL has been applied to most filters. These filters have some options in common:

Figure 17.1 Filters Common Options

Presets Filters presets are different from tool presets.

- A **text box** to enter a preset name or choose it in a drop down list.
- A  icon to save current settings as named preset.
- A  icon to manage preset.

Preview When this option is checked (default), changes in image are directly displayed in canvas. They are not applied to the image until you click on the OK button.

Split view When this option is checked, the image view is divided in two parts, filter applied on the left, filter not applied on the right.

Click-and-drag this split line to move it, and **Ctrl**-click it to make it horizontal.

Use the selection as input If this option is selected, the filter uses pixels in selection only.



Use the entire layer as input If this option is selected, selection contents is made from the entire layer. The layer outside the selection remains normal.



17.3 Blur Filters

17.3.1 Introduction

Figure 17.2 Original for demo



This is a set of filters that blur images, or parts of them, in various ways. If there is a selection, only the selected parts of an image will be blurred. There may, however, be some leakage of colors from the unblurred area into the blurred area. To help you pick the one you want, we will illustrate what each does when applied to the image shown at right. These are, of course, only examples: most of the filters have parameter settings that allow you to vary the magnitude or type of blurring.

Figure 17.3 Gaussian blur (radius 10)



The most broadly useful of these is the Gaussian blur. (Don't let the word "Gaussian" throw you: this filter makes an image blurry in the most basic way.) It has an efficient implementation that allows it to create a very blurry blur in a relatively short time.

Figure 17.4 Selective blur



The Selective Blur filter allows you to set a threshold so that only pixels that are similar to each other are blurred together. It is often useful as a tool for reducing graininess in photos without blurring sharp edges. (In the example, note that the graininess of the background has been reduced.) The implementation is much slower than a Gaussian blur, though, so you should not use it unless you really need the selectivity.

Figure 17.5 Pixelize



The Pixelize filter produces the well-known "Abraham Lincoln" effect by turning the image into a set of large square pixels. (The **Oilify** filter, in the Artistic Filters group, has a similar effect, but with irregular blobs instead of perfectly square pixels.)

Note

You can find a nice explanation of the Abraham Lincoln effect at [\[BACH04\]](#). You will see the Salvador Dali's painting "Gala Contemplating the Mediterranean Sea" turning to an Abraham Lincoln's portrait when looking at it from a distance.

With GIMP-2.10, the Motion Blur filter has been divided in Circular, Linear, and Zoom.

Figure 17.6 Circular Motion Blur filter



The Circular Motion Blur filter blurs in a rotational direction around a center that you can set.

Figure 17.7 Linear Motion Blur filter



The Linear Motion Blur filter blurs in a direction that you can set.

Figure 17.8 Zoom Motion Blur filter



The Zoom Motion Blur filter blurs in a radial direction around a center that you can set.

Finally, the Tileable Blur filter is really the same thing as a Gaussian blur, except that it wraps around the edges of an image to help you reduce edge effects when you create a pattern by tiling multiple copies of the image side by side.

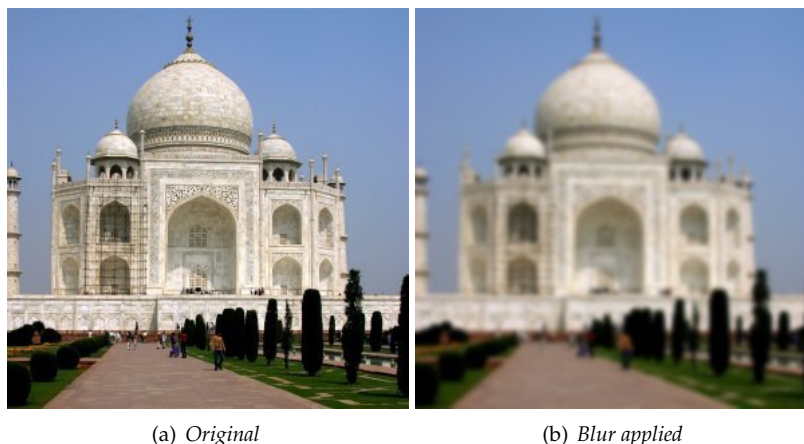
Note

Tileable Blur is actually implemented by a Script-Fu script that invokes the Gaussian blur plug-in.

17.3.2 Gaussian Blur

17.3.2.1 Overview

Figure 17.9 Example for the “Gaussian Blur” filter



(a) Original

(b) Blur applied

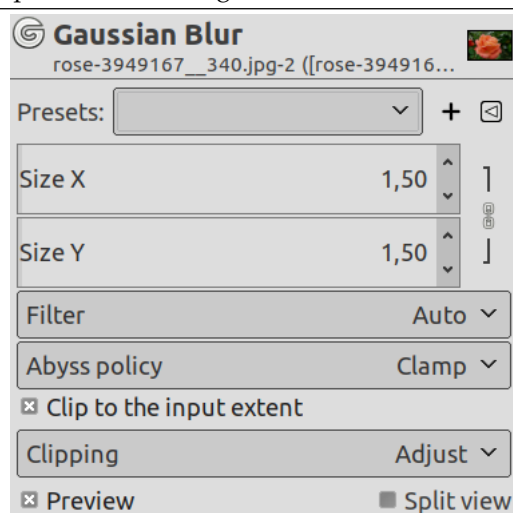
The Gaussian Blur plug-in acts on each pixel of the active layer or selection, setting its Value to the average of all pixel Values present in a radius defined in the dialog. A higher Value will produce a higher amount of blur. The blur can be set to act in one direction more than the other by clicking the Chain Button so that it is broken, and altering the radius. GIMP supports two implementations of Gaussian Blur: FIR and RLE. They both produce the same results, but each one can be faster in some cases.

17.3.2.2 Activate the filter

You can find this filter in the image menu under Filters → Blur → Gaussian Blur...

17.3.2.3 Options

Figure 17.10 “Gaussian” filter parameters settings



Presets, Preview, Split view These options are common to GEGL-based filters. Please refer to Section 17.2.

Size X, Size Y Here you can set the blur intensity. By altering the ratio of horizontal to vertical blur, you can give the effect of a motion blur.

Filter Auto: Try to select the right filter automatically.

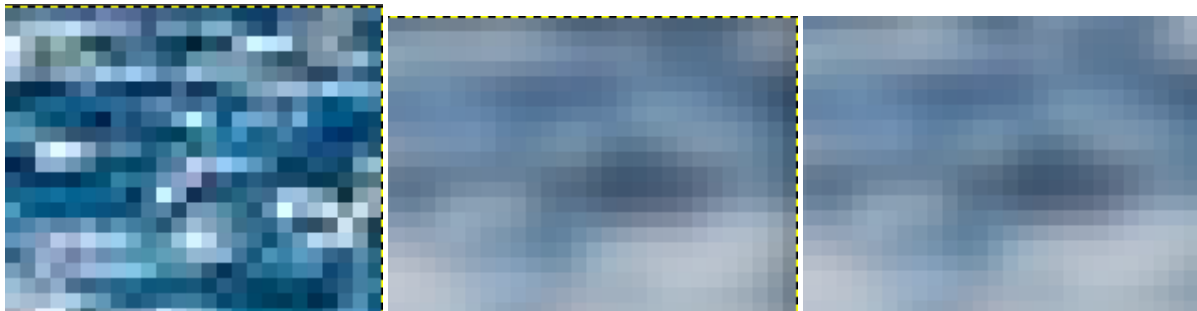
FIR: stands for “Finite Impulse Response”. For photographic or scanned images.

RLE: stands for “run-length encoding”. RLE Gaussian Blur is best used on computer-generated images or those with large areas of constant intensity.

Abyss policy Abyss policy (border management) is treated with **Abyss policy**.

Clip to the input extent Should the output extent be clipped to the input extent: this option removes unwanted pixels created on borders by blurring.

Figure 17.11 Example



(a) Right-up corner of the image, zoom x800 (b) “Clip to the input extent” unchecked (c) “Clip to the input extent” checked

Clipping The result of this filter can be larger than the original image. With the default Adjust option, the layer will be automatically resized as necessary when the filter is applied. With the Clip option the result will be clipped to the layer boundary.

The Gaussian Blur filter doesn’t preserve edges in the image:

Left: Origin
Middle: Median
Right: Gaussian

17.3.3 Mean Curvature Blur

17.3.3.1 Overview

Regularize geometry at a speed proportional to the local mean curvature value: this filter uses the mean curvature algorithm to blur the image preserving edges.

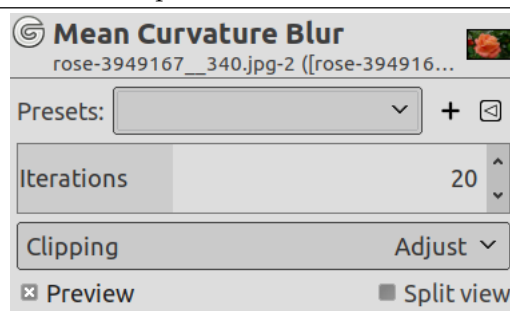
Mean Curvature algorithm is describes in [Wikipedia](#)

17.3.3.2 Activate the filter

You can find this filter in the image menu under Filters → Blur → Mean Curvature Blur...

17.3.3.3 Options

Figure 17.12 “Mean Curvature Blur” filter parameters



Presets, Preview, Split view These options are common to GEGL-based filters. Please refer to Section 17.2.

Iterations Increasing Iterations increases blur.

Clipping The result of this filter can be larger than the original image. With the default Adjust option, the layer will be automatically resized as necessary when the filter is applied. With the Clip option the result will be clipped to the layer boundary.

17.3.3.4 Examples



Original image



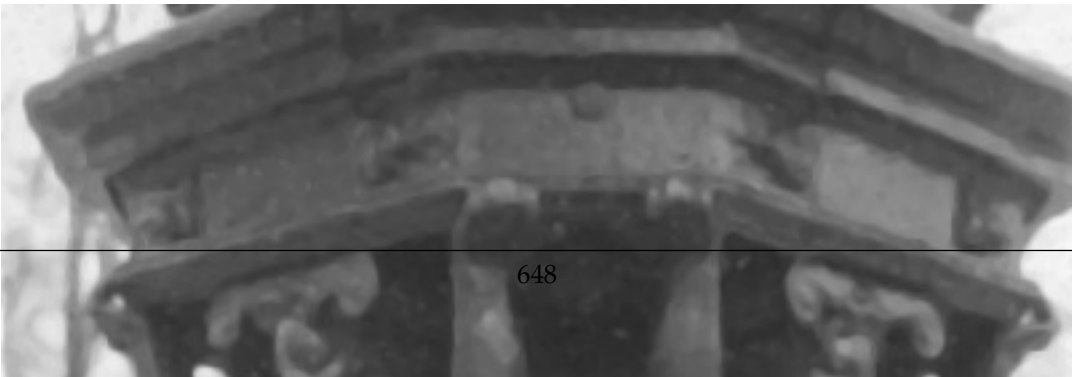
Iterations = 4

Mean Curvature Blur can be used to denoise an image:

Figure 17.13 Mean Curvature Blur to denoise



(a) Original image



17.3.4 Median Blur

17.3.4.1 Overview

While the “Gaussian” blur filter calculates the mean of the neighboring pixels, the “Median” blur filter calculates the median:

Figure 17.14 Calculating Median

223	186	114							
204	161	106	106	114	138	161	186	194	204
219	194	138							

A 3x3 neighborhood. Values in ascending order. Median surrounded in red.

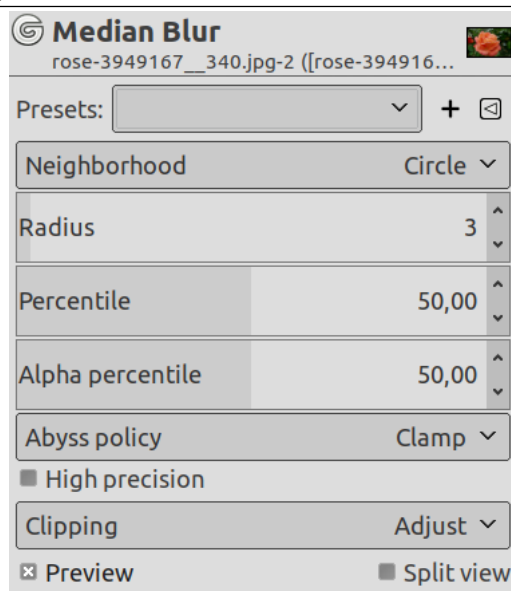
This calculation does not create a new value, and an unrepresentative pixel in the neighborhood will not affect the result. So, the filter preserves edges and rounds corners. It is used to reduce noise, especially salt and pepper noise, and delete scratches on photographs.

17.3.4.2 Activate the filter

You can find this filter in the image menu under Filters → Blur → Median Blur...

17.3.4.3 Options

Figure 17.15 “Median” filter parameters



Presets, Preview, Split view These options are common to GEGL-based filters. Please refer to Section 17.2.

Neighborhood The shape of the neighborhood. Three options: Square, Circle(default), Diamond. Differences are subtle and not predictable: experiment, on-canvas editing makes this easy.

Figure 17.16 “Median” Neighborhood



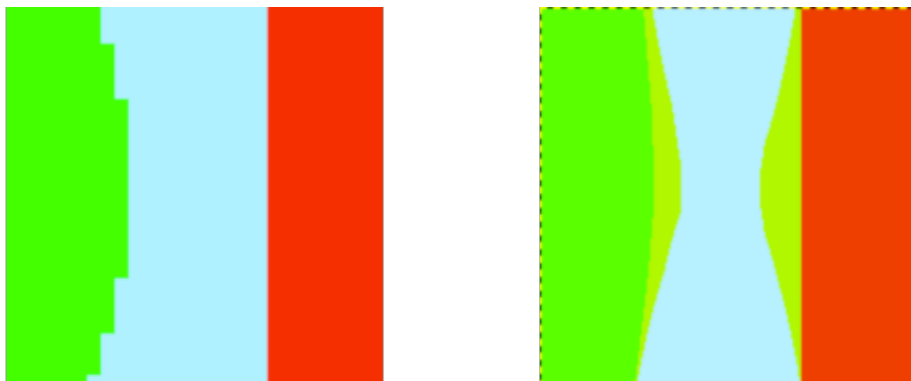
Radius=3.....Left: Square
Middle: Circle.....Right: Diamond

Radius The radius of the neighborhood. Increasing radius increases blur. Contrary to the “Gaussian” filter, edges are not blurred. Corners are rounded and convex surfaces are eroded.

Figure 17.17 “Median” blur vs “Gaussian” blur

Left: Origin
Middle: Median
Right: Gaussian

Increasing radius too much can create unwanted effects:



Left: Origin
Right: Radius=100

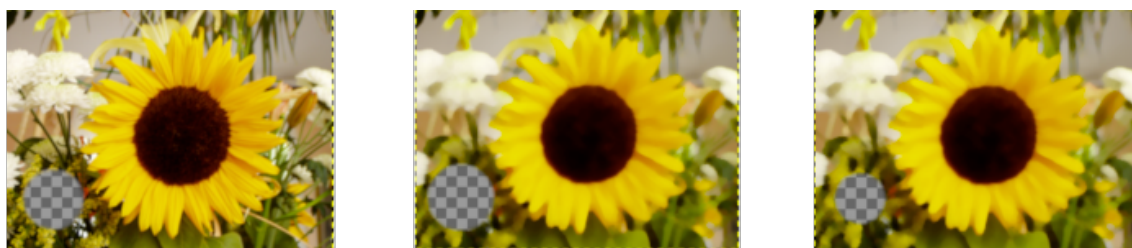
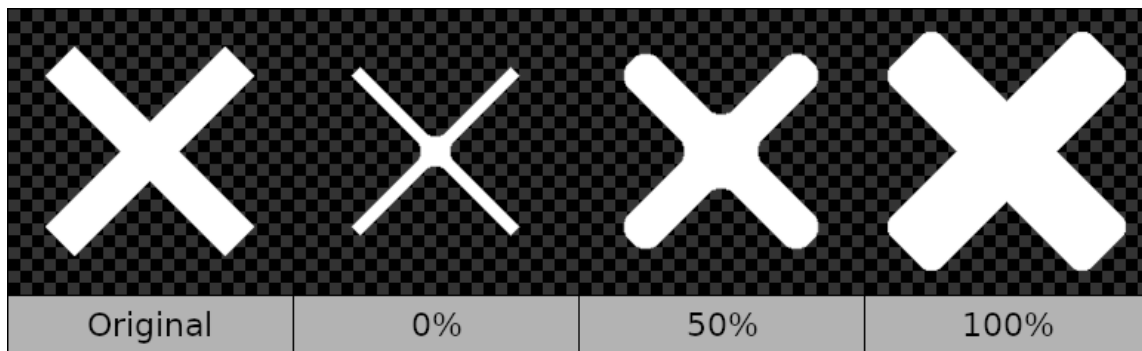
Percentile By default, the Median Blur filter finds the median value at the neighborhood of each pixel. In spite of its name, the filter can actually find *any* arbitrary percentile, not just the median (i.e., the 50th percentile). The “Percentile” parameter controls the percentile used for the color components. Lower values shift the image toward darker tones and higher values toward brighter ones.



Left: Origin
Middle: Percentile=0. Image is darker. Stems are enlarged but sharp.
Right: Percentile=100. Image is brighter and much blurred.

Alpha Percentile To see the effect of this parameter, you need an image with transparency. If the alpha channel is opaque everywhere, the result will also be fully opaque, regardless of the percentile.

Lower values for the “Alpha percentile” parameter shift the image toward more transparency, and higher values shift the image toward more opacity, where a value of 50% is balanced. Roughly speaking, values less than 50% make the opaque regions of the image smaller, while values greater than 50% make the opaque regions of the image larger.



Left: Origin. The image has an alpha channel. A circle is transparent.
 Middle: Percentile=0%. Transparent circle is enlarged.
 Right: Alpha percentile=100%. Transparent circle is reduced.

Abyss policy Abyss policy (border management) is treated with **Abyss policy**.

High precision This option avoids clipping and quantization but is slower.

17.3.4.4 Using Median Blur

Reducing salt and pepper noise



Left: origin (from Wikipedia)
 Middle: radius = 1 applied twice
 Right: radius = 1 applied three times

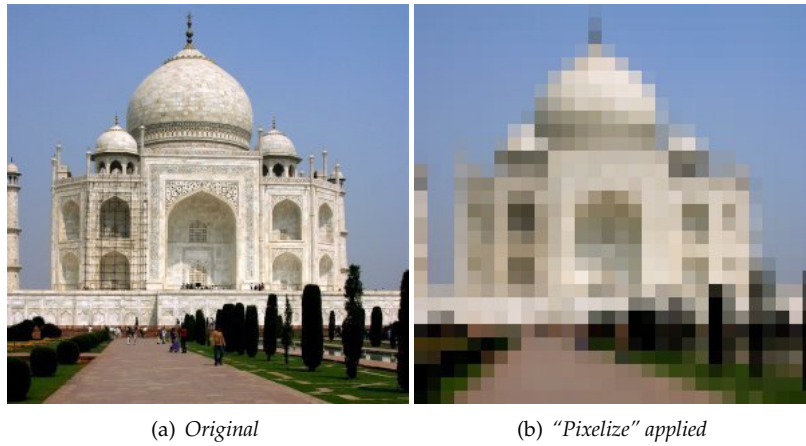
Reducing scratches

Left: origin
 Middle: radius = 2
 Right: radius = 1 applied twice. The image is less blurred.

17.3.5 Pixelize

17.3.5.1 Overview

Figure 17.18 Example for the “Pixelize” filter



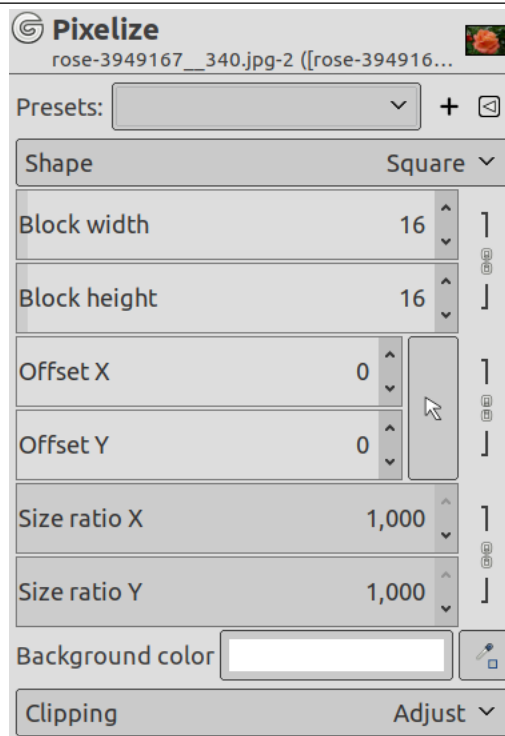
The Pixelize filter renders the image using large color blocks. It is very similar to the effect seen on television when obscuring a criminal during trial. It is used for the “Abraham Lincoln effect”: see [BACH04].

17.3.5.2 Activate the filter

You can find this filter in the image menu through Filters → Blur → Pixelize...

17.3.5.3 Options

Figure 17.19 “Pixelize” filter options



Presets This option is common to GEGl-based filters. Please refer to Section 17.2.

Shape TODO. Not working

Block width, Block height Here you can set the desired width and height of the blocks, in pixels.

By default, width and height are linked, indicated by the chain symbol next to the input boxes. If you want to set width and height separately, click on that chain symbol to unlink them.

Size ratio X, Size ratio Y Horizontal/Vertical size ratio (0.000-1.000) of a pixel inside a block. Default value is 1.000. The number of blocks remains the same; so, if you change ratio, block size changes, and missing pixels are replaced with the background color.

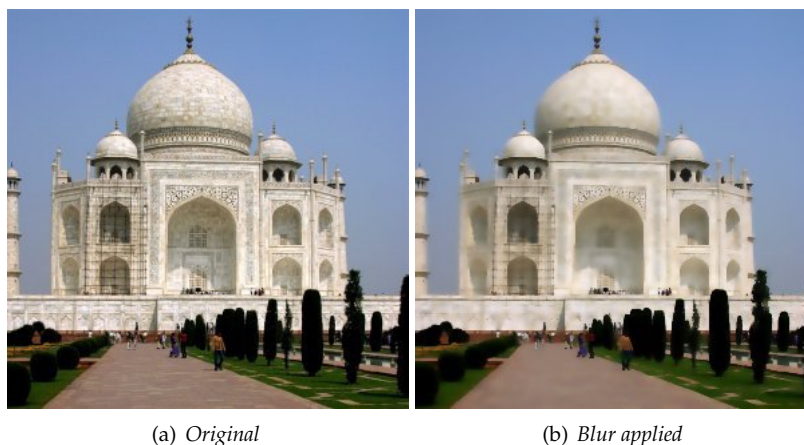
Background color Default background is that of toolbox. You can change it by clicking on color source or picking a color using the color picker on the right.

Clipping The result of this filter can be larger than the original image. With the default Adjust option, the layer will be automatically resized as necessary when the filter is applied. With the Clip option the result will be clipped to the layer boundary.

17.3.6 Selective Gaussian Blur

17.3.6.1 Overview

Figure 17.20 The Selective Gaussian Blur filter



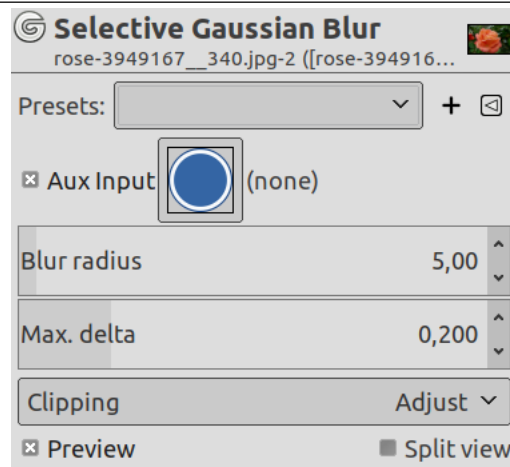
Contrary to the other blur plug-ins, the Selective Gaussian Blur plug-in doesn't act on all pixels: blur is applied only if the difference between its value and the value of the surrounding pixels is less than a defined Delta value. So, contrasts are preserved because difference is high on contrast limits. It is used to blur a background so that the foreground subject will stand out better. This adds a sense of depth to the image with only a single operation.

17.3.6.2 Activate the filter

You can find this filter in the image menu under Filters → Blur → Selective Gaussian Blur...

17.3.6.3 Options

Figure 17.21 “Selective Gaussian” filter parameters settings



Presets, Preview, Split view These options are common to GEGL-based filters. Please refer to Section 17.2.

Aux. input If there is another image on screen, you can select it as auxiliary input.

Blur radius Here you can set the blur intensity, in pixels.

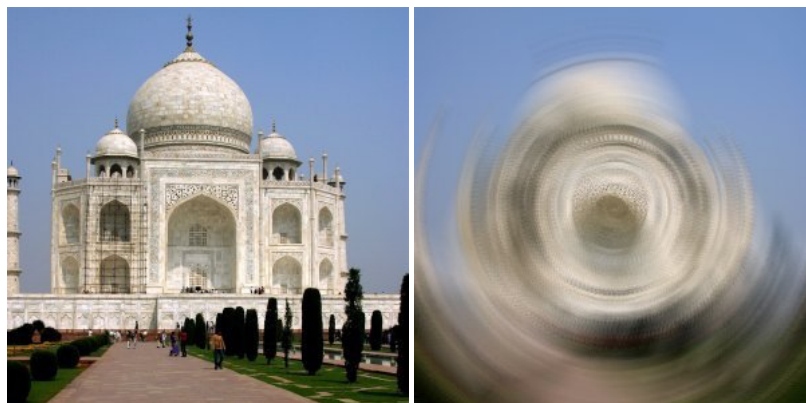
Max. delta Here you can set the maximum difference (0-255) between the pixel value and the surrounding pixel values. Above this Delta, blur will not be applied to that pixel.

Clipping The result of this filter can be larger than the original image. With the default Adjust option, the layer will be automatically resized as necessary when the filter is applied. With the Clip option the result will be clipped to the layer boundary.

17.3.7 Circular Motion Blur

17.3.7.1 Overview

Figure 17.22 The Circular Motion Blur filter



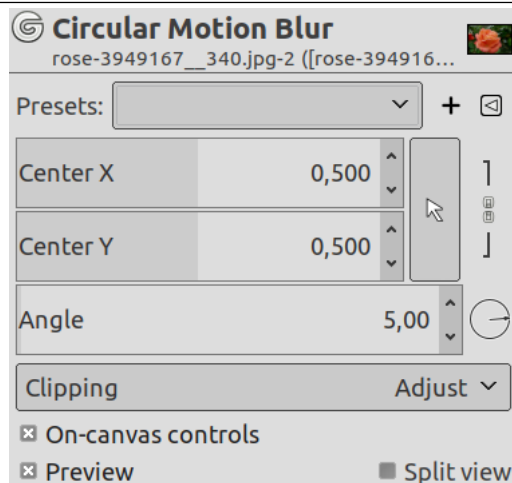
(a) Original

(b) Blur applied

This filter creates a circular blur around a center. The default center is the center of the layer or selection. You can set center somewhere in the layer and this center is applied to the layer or to a selection if it exists.

17.3.7.2 Options

Figure 17.23 “Circular Motion Blur” filter options



Presets, Preview, Split view These options are common to GEGL-based filters. Please refer to Section 17.2.

Center X, Center Y Here, you can set the rotation center. Sliders and spin buttons control the position of rotation center on horizontal and vertical axis. You can also click on the rectangle button with an arrow on the right and then click on the image to pick coordinates.

Angle More Angle will result in more blurring in a circular direction.

Clipping The result of this filter can be larger than the original image. With the default Adjust option, the layer will be automatically resized as necessary when the filter is applied. With the Clip option the result will be clipped to the layer boundary.

On-canvas controls This option (default) allows you to modify blur settings directly on canvas, for easier visual tweaking of blur settings. It displays a line with handle on both ends to move rotation center and transform.

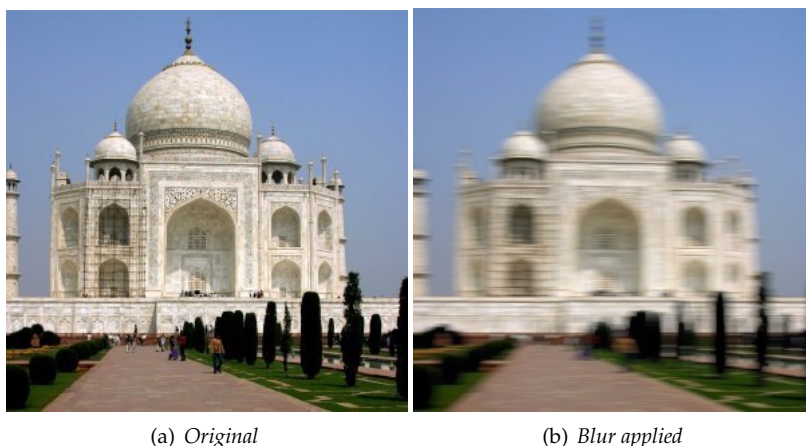
Press **Alt** key to only move rotation center without transforming.

Press **Ctrl** key to rotate by 15° steps.

17.3.8 Linear Motion Blur

17.3.8.1 Overview

Figure 17.24 The Linear Motion Blur filter



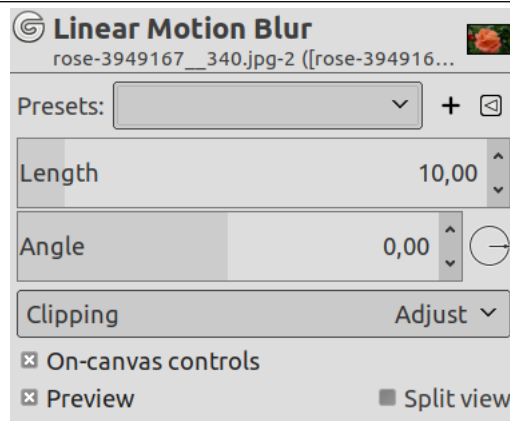
(a) Original

(b) Blur applied

This filter creates a linear blur in a direction determined by the “Angle” option. The default direction is horizontal to the right (0.000 degree).

17.3.8.2 Options

Figure 17.25 “Linear Motion Blur” filter options



Presets, Preview, Split view These options are common to GEGL-based filters. Please refer to Section 17.2.

Length In this case, “Length” represents the blur intensity. More Length will result in more blurring.

Angle “Angle” describes the direction of the movement. Thus, a setting of 90 will produce a vertical blur, and a setting of 0 will produce a horizontal blur.

Clipping The result of this filter can be larger than the original image. With the default Adjust option, the layer will be automatically resized as necessary when the filter is applied. With the Clip option the result will be clipped to the layer boundary.

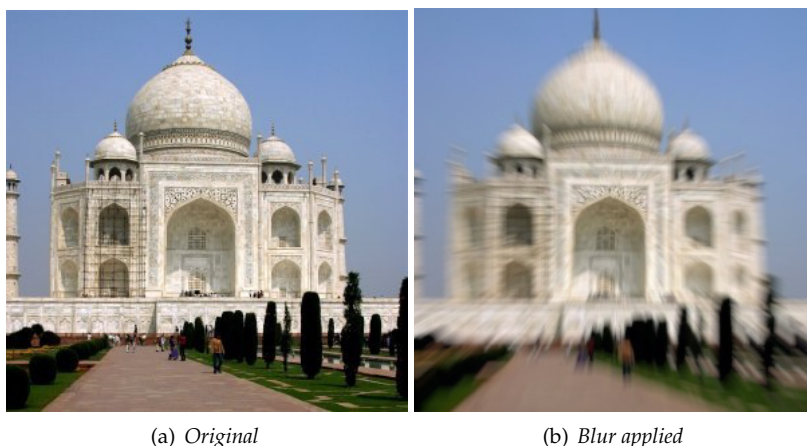
On-canvas controls This option (default) allows you to modify blur settings directly on canvas, for easier visual tweaking of blur settings. It displays a line with handle on both ends to vary direction and transform.

Press **Ctrl** key to change direction by 15° steps.

17.3.9 Zoom Motion Blur

17.3.9.1 Overview

Figure 17.26 The Zoom Motion Blur filter



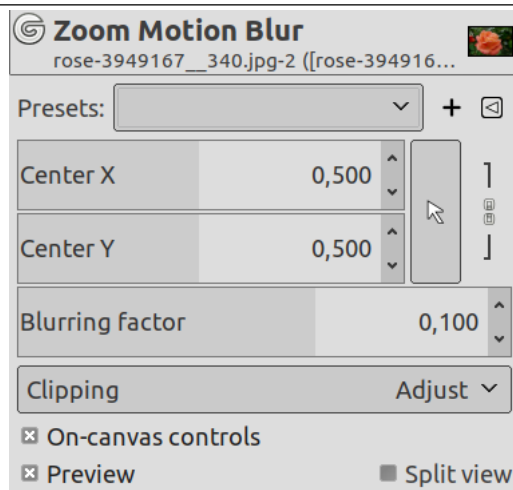
(a) Original

(b) Blur applied

The name of this filter should be “Radial”. It creates a blur in all directions around a center. The default center is the center of the layer or selection. You can set center somewhere in the layer and this center is applied to the layer or to a selection if it exists.

17.3.9.2 Options

Figure 17.27 “Zoom Motion Blur” filter options



Presets, Preview, Split view These options are common to GEGL-based filters. Please refer to Section 17.2.

Center X, Center Y Here, you can set the zoom center. Sliders and spin buttons control the position of zoom center on horizontal and vertical axis. You can also click on the rectangle button with an arrow on the right and then click on the image to pick coordinates.

Blurring factor Increasing factor will result in more blurring in a all directions of zoom.

Clipping The result of this filter can be larger than the original image. With the default Adjust option, the layer will be automatically resized as necessary when the filter is applied. With the Clip option the result will be clipped to the layer boundary.

On-canvas controls This option (default) allows you to modify blur settings directly on canvas, for easier visual tweaking of blur settings. It displays a line with handle on both ends to vary center and blurring factor.

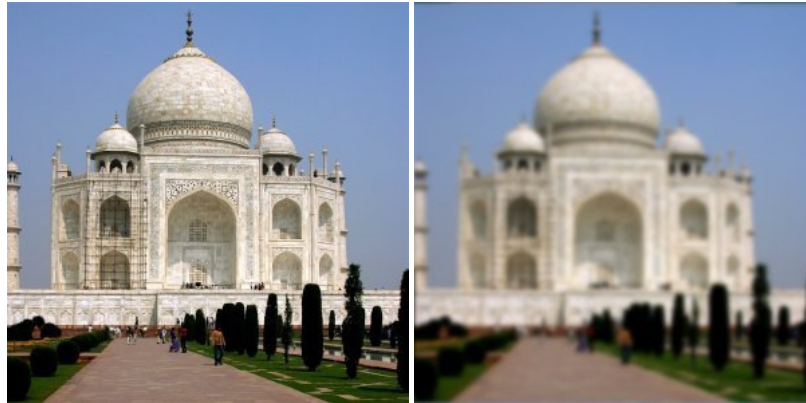
Press **Alt** key to vary center only.

Press **Ctrl** key to vary blurring factor only.

17.3.10 Tileable Blur

17.3.10.1 Overview

Figure 17.28 Example for the “Tileable” filter



(a) Original

(b) Filter “Tileable Blur” applied

This filter is a script-fu and not GEGL-based.

This filter is used to soften tile seams in images used in tiled backgrounds. It does this by blending and blurring the boundary between images that will be next to each other after tiling.

Tip

If you want to treat only images borders, you can't apply filter to the whole image. The solution to get the wanted effect is as follows:

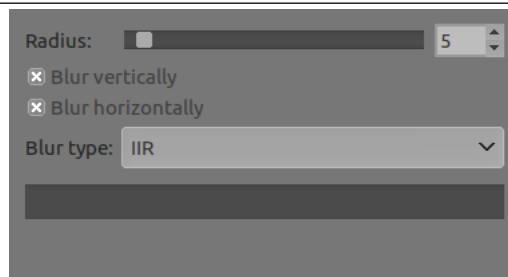
1. Duplicate layer (Layer → Duplicate Layer) and select it to work on it.
2. Apply “Tileable Blur” filter with a 20 pixels radius to this layer.
3. Select all (Ctrl-A) and reduce selection (Selection → Shrink) to create a border with the wanted width.
4. Give a feathered border to the selection by using Selection → Feather.
5. Delete selection with Ctrl-K.
6. Merge layers with Layer → Merge down.

17.3.10.2 Activate the filter

You can find this filter in the image menu under Filters → Blur → Tileable Blur...

17.3.10.3 Options

Figure 17.29 “Tileable Blur” filter options



Radius The bigger the radius, the more marked is the blur. By selecting Horizontal and Vertical, you can make the horizontal and vertical borders tileable.

Blur vertically, Blur horizontally These options are self-explanatory.

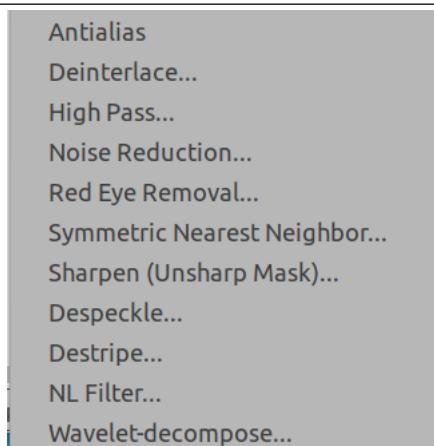
Blur type Choose the algorithm to be applied:

IIR for photographic or scanned images.

RLE for computer-generated images.

17.4 Enhance Filters

Figure 17.30 The Enhance filters menu



17.4.1 Introduction

Enhance filters are used to compensate for image imperfections. Such imperfections include dust particles, noise, interlaced frames (coming usually from a TV frame-grabber) and insufficient sharpness.

17.4.2 Antialias

17.4.2.1 Overview

This filter reduces alias effects (see [Antialiasing](#)) using the Scale3X edge-extrapolation algorithm.

Scale3X is derived from Scale2X, which is a graphics effect to increase the size of small bitmaps guessing the missing pixels without interpolating pixels and blurring the images.¹ Scale2X was originally de-

¹[[SCALE2X](#)].

veloped to improve the quality of old Arcade and PC games with a low video resolution played with video hardware like TVs, Arcade monitors, PC monitors and LCD screens.²

The Antialias filter works as follows:

For every pixel,

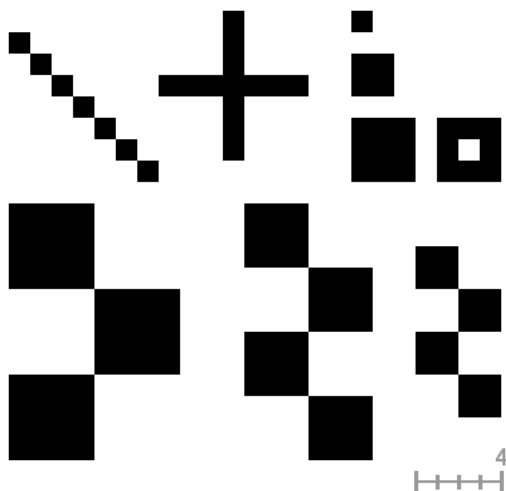
1. the filter expands the original pixel in 9 (3x3) new pixels according to the Scale3X algorithm, using the colors of the pixel and its 8 adjacent pixels (extrapolation);
2. then the filter subsamples the new pixels to a weighted average pixel.

17.4.2.2 Activating the filter

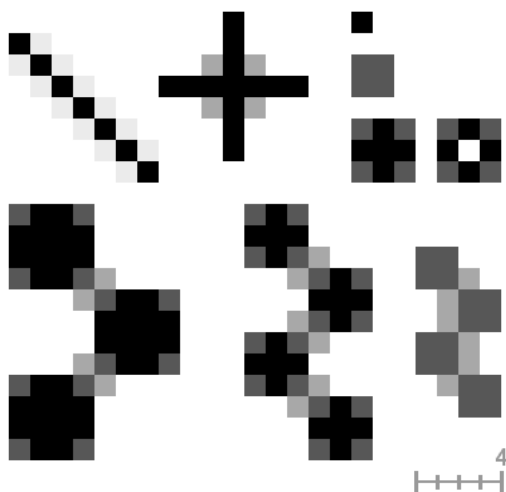
You can find this filter through Filters → Enhance → Antialias.

17.4.2.3 Examples

The following examples illustrate the effect on some patterns. The small squares are one pixel in size (zoom 16:1).



Original image (zoom 16:1)



"Antialias" applied (zoom 16:1)

²[[AdvanceMAME](#)].

17.4.3 Deinterlace

17.4.3.1 Overview

Images captured by videocards, especially when fast movement is recorded, may look blurred and stripped, with split objects. This is due to how cameras work. They don't record 25 images per second, but 50, with half vertical resolution. There are two interlaced images in one frame. First line of first image is followed by first line of second image followed by second line of first image... etc. So, if there have been an important move between the two images, objects will appear split, shifted, stripped.

The Deinterlace filter keeps only one of both images and replaces missing lines by a gradient between previous and following lines. The resulting image, or selection, will be somewhat blurred, but can be improved by enhance filters

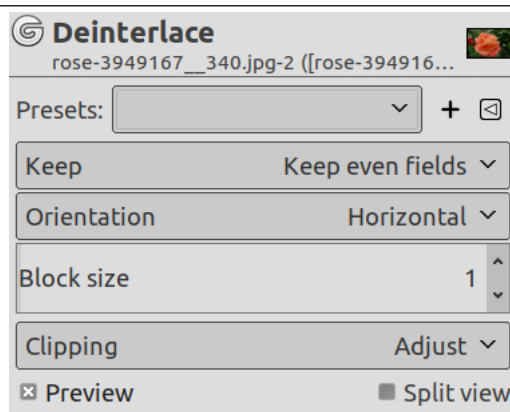
You can find interlaced images at [\[WKPD-DEINTERLACE\]](#).

17.4.3.2 Activating the filter

You can find this filter through Filters → Enhance → Deinterlace....

17.4.3.3 Options

Figure 17.31 Deinterlace filter options



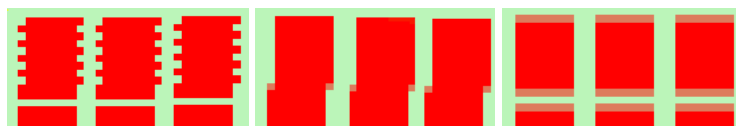
Preview If checked, parameter setting results are interactively displayed in preview.

Keep odd fields, Keep even fields One of them may render a better result. You must try both.

Clipping The result of this filter can be larger than the original image. With the default Adjust option, the layer will be automatically resized as necessary when the filter is applied. With the Clip option the result will be clipped to the layer boundary.

17.4.3.4 Example

Figure 17.32 Simple applying example for the Deinterlace filter



(a) Top: even lines pixels are shifted by one pixel to the right. Bottom: one line is being shifted to the right, have been shifted to the left, missing. These images are to align themselves with the even lines.

(b) "Keep even fields" Top: odd lines have checked. Bottom: the empty line has been filled with red.

(c) "Keep odd fields" Top: even lines right. Bottom: the empty line persists, but joins up and down through a gradient.

17.4.4 High Pass

17.4.4.1 Overview

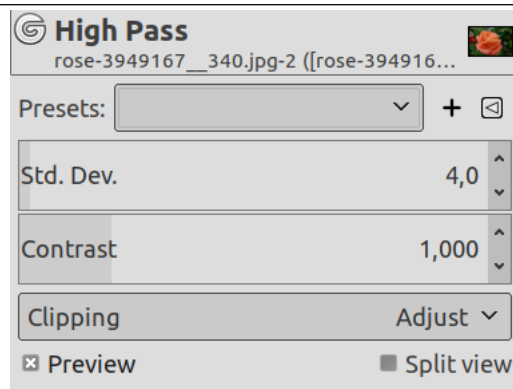
In sound processing, a high-pass filter filters high frequencies above a threshold. In digital images, frequency refers to sudden changes in brightness or color in neighboring pixels. The High Pass filter filters high essential details, and larger scale gradients are removed. This result, combined with the original image and "Soft Light" or "Hard Light" merge mode, is used to sharpen images. It enhances fine details.

17.4.4.2 Activating the filter

You can find this filter through Filters → Enhance → High Pass....

17.4.4.3 Options

Figure 17.33 "High Pass" filter options



Presets, Preview, Split view These options are common to GEGL-based filters. Please refer to Section 17.2.

Std. Dev. Increasing this Standard Deviation lowers the filter threshold and more image details are taken in account for treatment.

Contrast Increase/Decrease contrast of treated details.

Clipping The result of this filter can be larger than the original image. With the default Adjust option, the layer will be automatically resized as necessary when the filter is applied. With the Clip option the result will be clipped to the layer boundary.

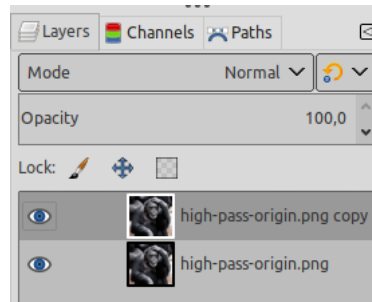
17.4.4.4 Using High Pass Filter

Sharpening

1. Open your image:



2. Duplicate layer:

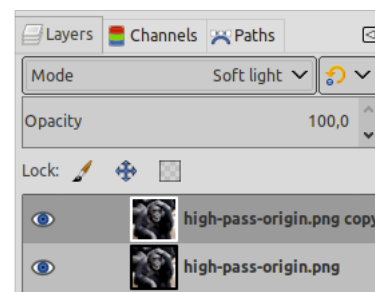


This duplicate layer becomes the active layer.

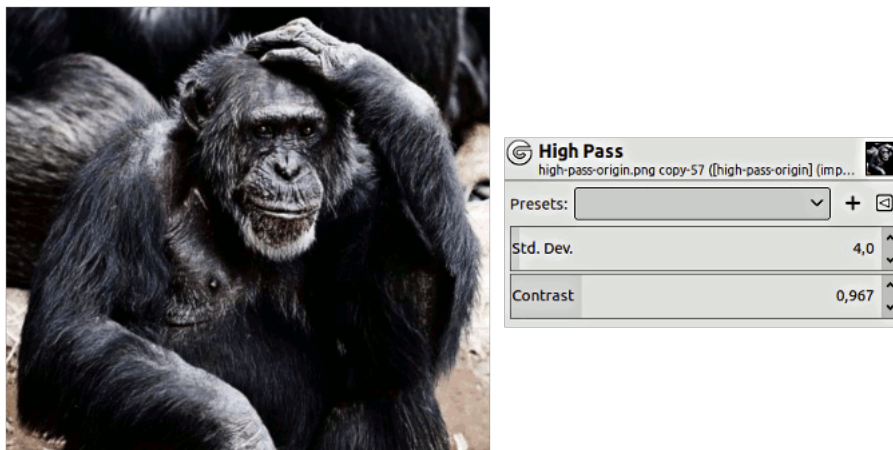
3. Open High Pass filter.



4. Change mode to soft-light (try Hard-light also).



5. Settings and on-canvas view



17.4.5 Noise Reduction

17.4.5.1 Overview

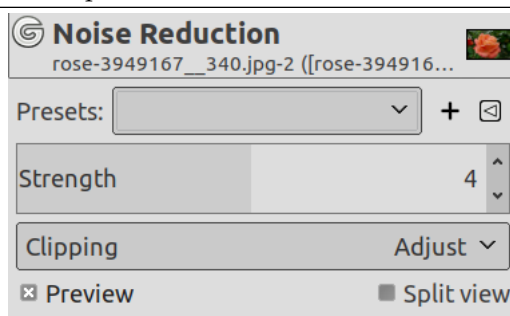
A simple GEGL filter to reduce noise.

17.4.5.2 Activating the filter

You can find this filter through Filters → Enhance → Noise Reduction....

17.4.5.3 Options

Figure 17.34 Noise Reduction filter options



Presets, Preview, Split view These options are common to GEGL-based filters. Please refer to Section [17.2](#).

Strength Increasing Strength lessens noise, and increases blur: find compromise using the on-canvas preview.

Clipping The result of this filter can be larger than the original image. With the default Adjust option, the layer will be automatically resized as necessary when the filter is applied. With the Clip option the result will be clipped to the layer boundary.

17.4.5.4 Example



Original

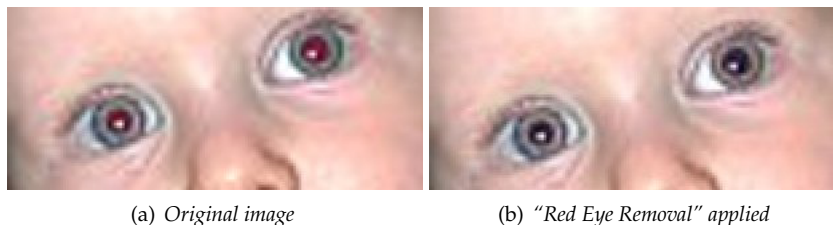


Filter applied. Strength = 5

17.4.6 Red Eye Removal

17.4.6.1 Overview

Figure 17.35 Example for the “Red Eye Removal” filter



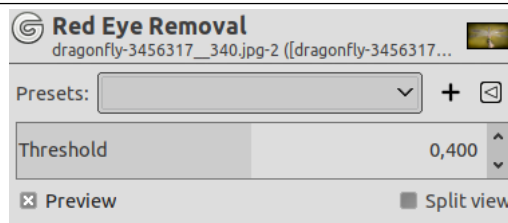
The aim of this filter is - guess what - to remove red eyes from an image. Before applying the “Red Eye Removal” you must do a selection (lasso or elliptical) of the boundary of the iris of the eye(s) having a red pupil. After only you can apply the filter on this selection. If you don’t make this selection, the filter inform you that : “Manually selecting the eyes may improve the results”.

17.4.6.2 Activating the filter

This filter is found in the image window menu under Filters → Enhance → Red Eye Removal....

17.4.6.3 Options

Figure 17.36 “Red Eye Removal” options



Preview If you check “Preview” you can see the modifications in real-time in the preview window. And you can choose the good value of threshold compared with what you see, and then validate it.

Threshold If you move the cursor of threshold the amount of red color to eliminate will vary.

17.4.7 Symmetric Nearest Neighbor

17.4.7.1 Overview

This filter blurs the image preserving edges. It is very effective in noise reduction maintaining sharp edges.

It works comparing each pixel to its neighboring pixels and to 1 or 2 *pairs* of symmetric pixels around the center.



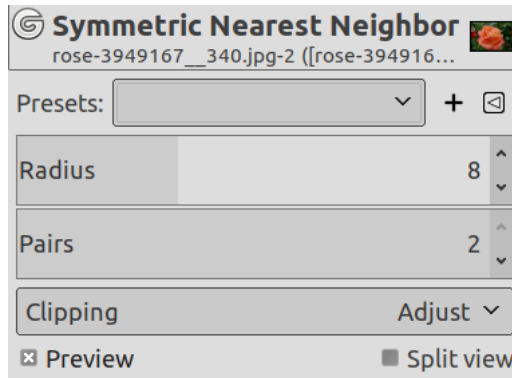
4 symmetric pairs

17.4.7.2 Activating the filter

You can find this filter through Filters → Enhance → Symmetric Nearest Neighbor....

17.4.7.3 Options

Figure 17.37 “Symmetric Nearest neighbor” filter options



Presets, Preview, Split view These options are common to GEGL-based filters. Please refer to Section 17.2.

Radius Radius, in pixels, of square pixel region. Width and height of this region are $radius*2+1$:



Pairs You can select 1 or 2 pairs : higher number preserves more acute features.

Clipping The result of this filter can be larger than the original image. With the default Adjust option, the layer will be automatically resized as necessary when the filter is applied. With the Clip option the result will be clipped to the layer boundary.

17.4.7.4 Example



Left: original.....Right: filter applied

17.4.8 Sharpen (Unsharp Mask)

17.4.8.1 Overview

Figure 17.38 Applying example for the Sharpen filter



(a) Original image

(b) Filter “Sharpen” applied

Out-of-focus photographs and most digitized images often need a sharpness correction. This is due to the digitizing process that must chop a color continuum up in points with slightly different colors: elements thinner than sampling frequency will be averaged into an uniform color. So sharp borders are rendered a little blurred. The same phenomenon appears when printing color dots on paper.

The Sharpen filter (old name was Unsharp Mask) sharpens edges of the elements without increasing noise or blemish. It is the king of the sharpen filters.

Tip



Some imaging devices like digital cameras or scanners offer to sharpen the created images for you. We strongly recommend you disable the sharpening in this devices and use the GIMP filters instead. This way you regain the full control over the sharpening of your images.

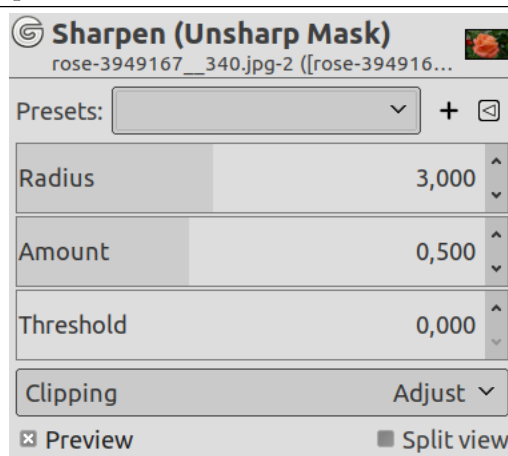
To prevent color distortion while sharpening, Decompose your image to HSV and work only on Value. Then Compose the image to HSV. Go to Colors → Components → Decompose.... Make sure the Decompose to Layers box is checked. Choose HSV and click OK. You will get a new grey-level image with three layers, one for Hue, one for Saturation, and one for Value. (Close the original image so you won't get confused). Select the Value layer and apply your sharpening to it. When you are done, with that same layer selected, reverse the process. Go to Colors → Components → Compose.... Again choose HSV and click OK. You will get back your original image except that it will have been sharpened in the Value component.

17.4.8.2 Activating the filter

You can find this filter through Filters → Enhance → Sharpen (Unsharp Mask)....

17.4.8.3 Options

Figure 17.39 “Sharpen” filter options



Preview If checked, parameter setting results are interactively displayed in preview. Scroll bars allow you to move around the image.

Radius The slider and input boxes (0.1-120) allow you to set how many pixels on either side of an edge will be affected by sharpening. High resolution images allow higher radius. It is better to always sharpen an image at its final resolution.

Amount This slider and input boxes (0.00-5.00) allow you to set strength of sharpening.

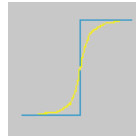
Threshold This slider and input boxes (0-255) allow you to set the minimum difference in pixel values that indicates an edge where sharpen must be applied. So you can protect areas of smooth tonal transition from sharpening, and avoid creation of blemishes in face, sky or water surface.

Clipping The result of this filter can be larger than the original image. With the default Adjust option, the layer will be automatically resized as necessary when the filter is applied. With the Clip option the result will be clipped to the layer boundary.

17.4.8.4 How does an unsharp mask work?

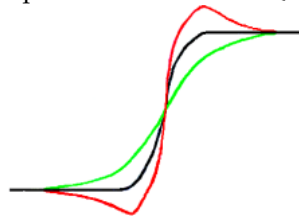
Using an unsharp mask to sharpen an image can seem rather weird. Here is the explanation:

Think of an image with a contrast in some place. The intensity curve of the pixels on a line going through this contrast will show an abrupt increase of intensity: like a stair if contrast is perfectly sharp (blue), like an S if there is some blur (yellow).



Now, we have an original image with some blur (black curve) we want to sharpen. We apply some more blur: the intensity variation will be more gradual (green curve).

Let us subtract the difference between blurredness intensity (green curve) and the intensity of the original image (black curve) to the intensity of the original image (black curve). We get the red curve, which is more abrupt: contrast and sharpness are increased. QED.



Unsharp mask has first been used in silver photography. The photograph first creates a copy of the original negative by contact, on a film, placing a thin glass plate between both; that will produce a blurred copy because of light diffusion. Then he places both films, exactly corresponding, in a photo enlarger, to reproduce them on paper. The dark areas of the positive blurred film, opposed to the clear areas of the original negative will prevent light to go through and so will be subtracted from the light going through the original film.

In digital photography, with GIMP, you will go through the following steps:

1. Open your image and duplicate it Image → Duplicate
2. In the copy, duplicate the layer Layer → Duplicate layer, then drop the Filters menu down and apply Blur → Gaussian Blur to the duplicated layer with the default IIR option and radius 5.
3. In the layer dialog of the duplicated image, change Mode to “Subtract”, and in the right-click menu, select “Merge down”.
4. Click and drag the only layer you got into the original image, where it appears as a new layer.
5. Change the Mode in this layer dialog to “Addition”.

Voilà. The “Unsharp Mask” plug-in does the same for you.

At the beginning of the curve, you can see a dip. If blurring is important, this dip is very deep; the result of the subtraction can be negative, and a complementary color stripe will appear along the contrast, or a black halo around a star on the light background of a nebula (black eye effect).

Figure 17.40 Black eye effect



17.4.9 Despeckle

17.4.9.1 Overview

This filter is used to remove small defects due to dust, or scratches, on a scanned image, and also moiré effects on image scanned from a magazine. You should select isolated defects before applying this filter, in order to avoid unwanted changes in other areas of your image. The filter replaces each pixel with the median value of the pixels within the specified radius.

17.4.9.2 Activating the filter

You can find this filter through Filters → Enhance → Despeckle....

17.4.9.3 Options

Figure 17.41 “Despeckle” filter options



Preview If checked, parameter setting results are interactively displayed in preview.

Median

Adaptive Adapts the radius to image or selection content by analyzing the histogram of the region around the target pixel. The adapted radius will always be equal to or smaller than the specified radius.

Recursive Repeats filter action which gets stronger.

Radius Sets size of action window from 1 (3x3 pixels) to 20 (41x41). This window moves over the image, and the color in it is smoothed, so imperfections are removed.

Black level Only include pixels brighter than the set value in the histogram (-1-255).

White level Only include pixels darker than the set value in the histogram (0-256).

17.4.10 Destripe

17.4.10.1 Overview

It is used to remove vertical stripes caused by poor quality scanners. It works by adding a pattern that will interfere with the image, removing stripes if setting is good. This “negative” pattern is calculated from vertical elements of the image, so don’t be surprised if you see stripes on the preview of an image that has none. And if pattern “strength”; is too high, your image will be striped.

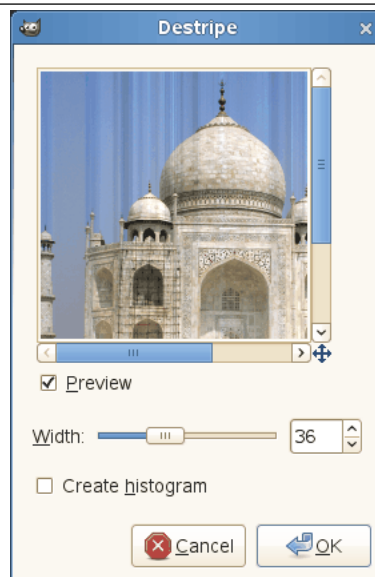
If, after a first pass, a stripe persists, rectangular-select it and apply filter again (all other selection type may worsen the result).

17.4.10.2 Activating the filter

You can find this filter through Filters → Enhance → Destripe....

17.4.10.3 Options

Figure 17.42 “Destripe” filter options



Preview If checked, parameter setting results are interactively displayed in preview. Scroll bars allow you to move around the image.

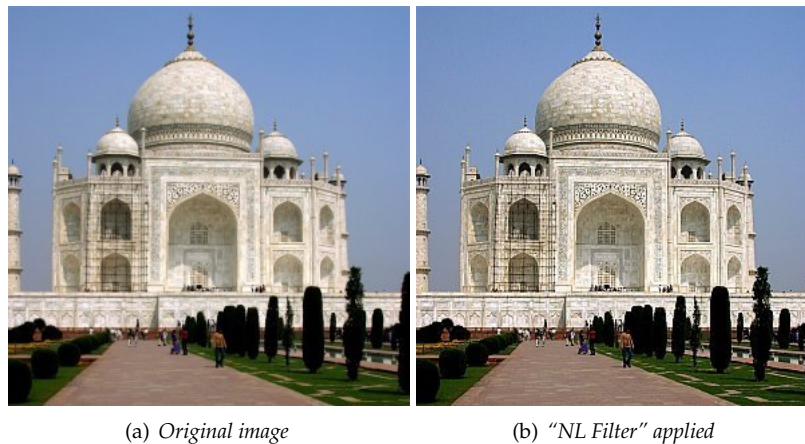
Create histogram This “histogram ” is a black and white image showing the interference pattern more legibly.

Width Slider and input box allow to set “strength” of filter (2-100): more than 60 is rarely necessary and may create artifacts.

17.4.11 NL Filter

17.4.11.1 Overview

Figure 17.43 Example for the NL-Filter



NL means “Non Linear”. Derived from the Unix `pnmnlfilt` program, it joins smoothing, despeckle and sharpen enhancement functions. It works on the whole layer, not on the selection.

This is something of a swiss army knife filter. It has 3 distinct operating modes. In all of the modes each pixel in the image is examined and processed according to it and its surrounding pixels values. Rather than using 9 pixels in a 3x3 block, it uses an hexagonal block whose size can be set with the Radius option.

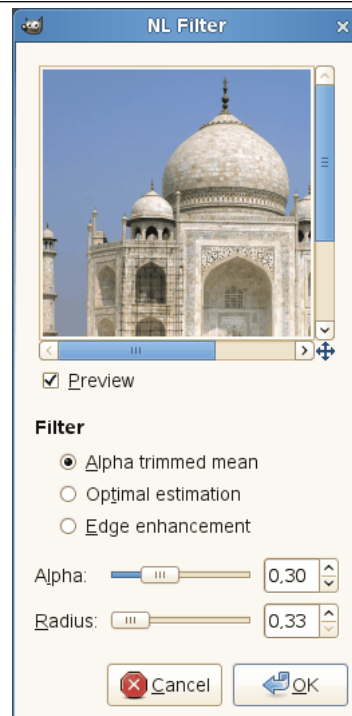
17.4.11.2 Activating the filter

You can find this filter through Filters → Enhance → NL Filter...

The filter does not work if the active layer has an alpha channel. Then the menu entry is insensitive and grayed out.

17.4.11.3 Options

Figure 17.44 “NL Filter” options



Preview When checked, parameter setting results are interactively displayed in preview.

Filter The **Operating Mode** is described below.

Alpha Controls the amount of the filter to apply. Valid range is 0.00-1.00. The exact meaning of this value depends on the selected operating mode. Note that this parameter is related to but not the same as the *alpha* parameter used in the `pnmnlfilt` program.

Radius Controls the size of the effective sampling region around each pixel. The range of this value is 0.33-1.00, where 0.33 means just the pixel itself (and thus the filter will have no effect), and 1.00 means all pixels in the 3x3 grid are sampled.

17.4.11.4 Operating Modes

This filter can perform several distinct functions:

Alpha trimmed mean The value of the center pixel will be replaced by the mean of the 7 hexagon values, but the 7 values are sorted by size and the top and bottom *Alpha* portion of the 7 are excluded from the mean. This implies that an *Alpha* value of 0.0 gives the same sort of output as a normal convolution (i.e. averaging or smoothing filter), where *Radius* will determine the “strength” of the filter. A good value to start from for subtle filtering is *Alpha* = 0.0, *Radius* = 0.55. For a more blatant effect, try *Alpha* = 0.0 and *Radius* = 1.0.

An *Alpha* value of 1.0 will cause the median value of the 7 hexagons to be used to replace the center pixel value. This sort of filter is good for eliminating “pop” or single pixel noise from an image without spreading the noise out or smudging features on the image. Judicious use of the *Radius* parameter will fine tune the filtering.

Intermediate values of *Alpha* give effects somewhere between smoothing and “pop” noise reduction. For subtle filtering try starting with values of *Alpha* = 0.8, *Radius* = 0.6. For a more blatant effect try *Alpha* = 1.0, *Radius* = 1.0.

Optimal estimation This type of filter applies a smoothing filter adaptively over the image. For each pixel the variance of the surrounding hexagon values is calculated, and the amount of smoothing is made inversely proportional to it. The idea is that if the variance is small then it is due to noise in the image, while if the variance is large, it is because of “wanted” image features. As usual the *Radius* parameter controls the effective radius, but it probably advisable to leave the radius between 0.8 and 1.0 for the variance calculation to be meaningful. The *Alpha* parameter sets the noise threshold, over which less smoothing will be done. This means that small values of *Alpha* will give the most subtle filtering effect, while large values will tend to smooth all parts of the image. You could start with values like *Alpha* = 0.2, *Radius* = 1.0, and try increasing or decreasing the *Alpha* parameter to get the desired effect. This type of filter is best for filtering out dithering noise in both bitmap and color images.

Edge enhancement This is the opposite type of filter to the smoothing filter. It enhances edges. The *Alpha* parameter controls the amount of edge enhancement, from subtle (0.1) to blatant (0.9). The *Radius* parameter controls the effective radius as usual, but useful values are between 0.5 and 0.9. Try starting with values of *Alpha* = 0.3, *Radius* = 0.8.

17.4.11.4.1 Combination use

The various operating modes can be used one after the other to get the desired result. For instance to turn a monochrome dithered image into grayscale image you could try one or two passes of the smoothing filter, followed by a pass of the optimal estimation filter, then some subtle edge enhancement. Note that using edge enhancement is only likely to be useful after one of the non-linear filters (alpha trimmed mean or optimal estimation filter), as edge enhancement is the direct opposite of smoothing.

For reducing color quantization noise in images (i.e. turning .gif files back into 24 bit files) you could try a pass of the optimal estimation filter (*Alpha* = 0.2, *Radius* = 1.0), a pass of the median filter (*Alpha* = 1.0, *Radius* = 0.55), and possibly a pass of the edge enhancement filter. Several passes of the optimal estimation filter with declining *Alpha* values are more effective than a single pass with a large *Alpha* value. As usual, there is a trade-off between filtering effectiveness and losing detail. Experimentation is encouraged.

17.4.12 Wavelet Decompose

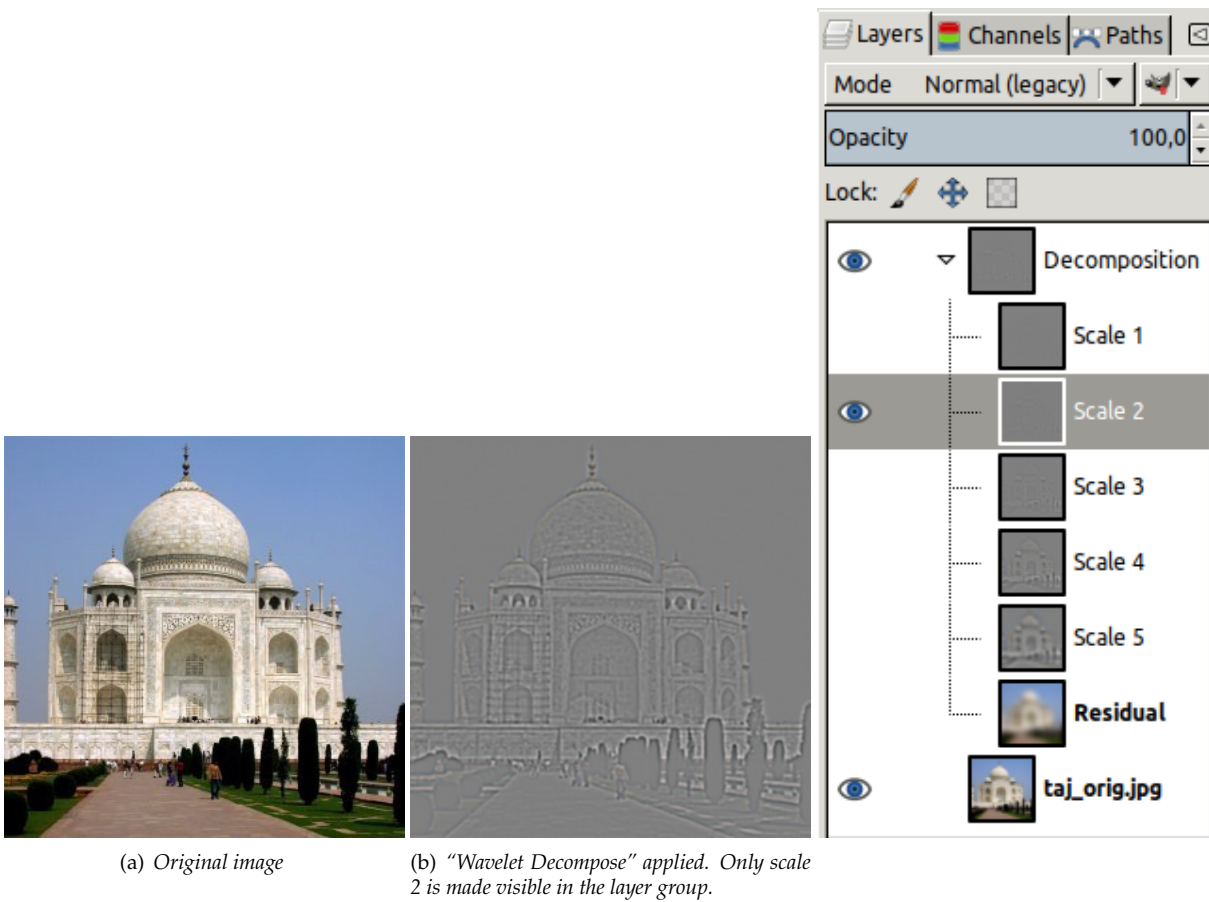
17.4.12.1 Overview

Note



Explanations are mostly inspired from the Pat David's tutorials <https://patdavid.net/2011/12/getting-around-in-gimp-skin-retouching.html> and <https://patdavid.net/2014/07/wavelet-decompose-again.html>.

Figure 17.45 Example for “Wavelet decompose” filter



This filter decomposes the active layer or selection into several layers, named “scales”, each of them containing a particular set of details. Finest details are in first layers and they become larger until you get to the last one, at bottom. This last layer is called “residual” and holds what is left after all detail layers have been removed; it represents the global contrast and colors of the image.

Each of scale layers are set to combine using the Grain Merge layer mode. This means that pixels that have a 50% value will not affect the final result. So, painting a wavelet scale with neutral gray (R:50% G:50% B:50%) will erase details.

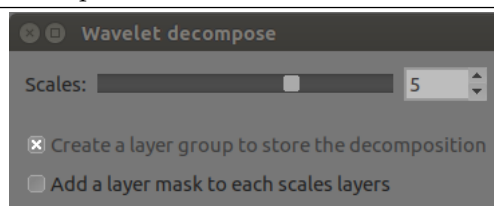
Wavelet-decompose is a wonderful filter for skin smoothing and retouching, removing blemishes, wrinkles, spots from your photos. It can be used also for sharpening and local contrast enhancement and for removing stains, colors, tones. All this is well explained in tutorials mentioned above.

17.4.12.2 Activating the filter

This filter is found in the image window menu under Filters → Enhance → Wavelet decompose.

17.4.12.3 Options

Figure 17.46 “Wavelet decompose” options



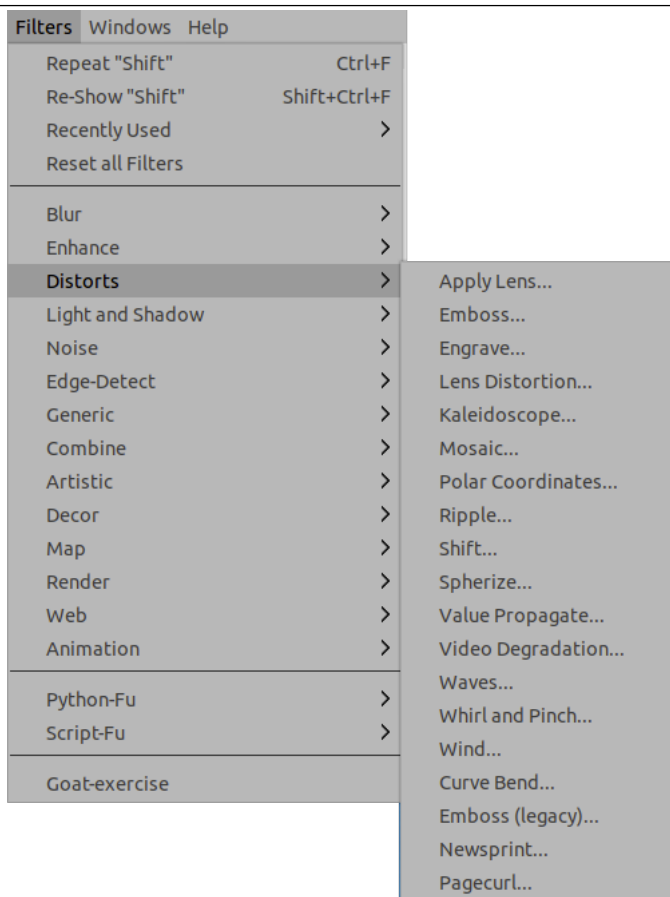
Scales: Default scales number is 5. You can increase it to increase scale fineness.

Create a layer group to store the decomposition: layer groups are treated in Section 8.4.

Add a layer mask to each scale layer: layer masks are treated in Section 15.2.1.3.

17.5 Distort Filters

Figure 17.47 The Distort filters menu



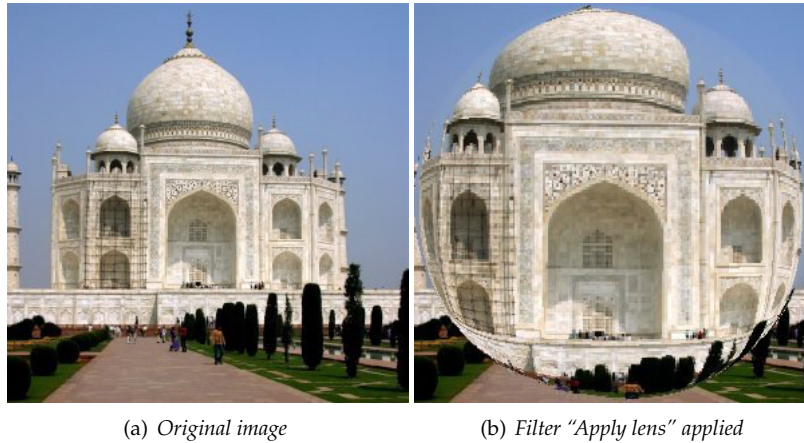
17.5.1 Introduction

The distort filters transform your image in many different ways.

17.5.2 Apply Lens

17.5.2.1 Overview

Figure 17.48 The same image, before and after applying lens effect.



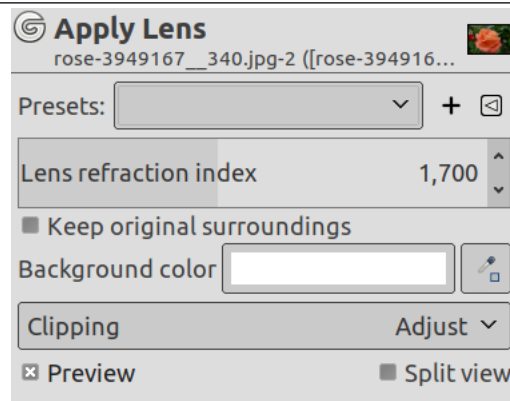
After applying this filter, a part of the active layer is rendered as through a spherical lens.

17.5.2.2 Activate the filter

You can find this filter in the image window menu through Filters → Distorts → Apply Lens...

17.5.2.3 Options

Figure 17.49 "Apply Lens" filter options



Presets, Preview, Split view

Note



These options are described in Section [17.2](#).

Lens refraction index Lens will be more or less convergent (1-100).

Keep original surroundings The lens seems to be put on the active layer.

Background color The part of the active layer outside the lens will have the background color selected in the toolbox.

You can select the color:

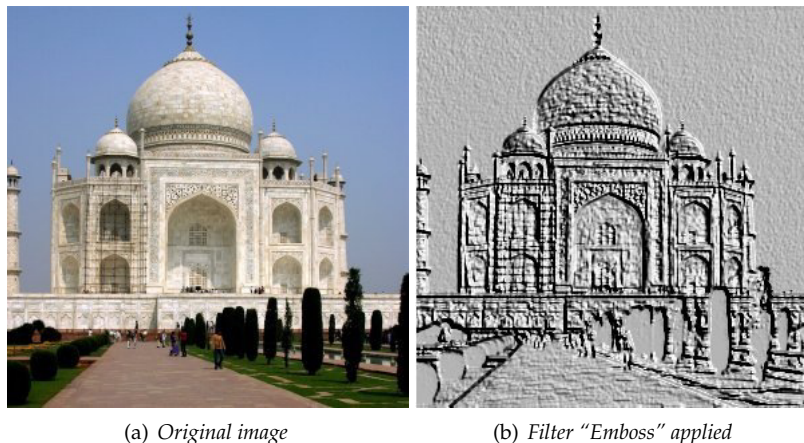
- Click on color dwell to open the color selector dialog.
- Click on the eye-drop button on the right to pick color from the image.

Clipping The result of this filter can be larger than the original image. With the default Adjust option, the layer will be automatically resized as necessary when the filter is applied. With the Clip option the result will be clipped to the layer boundary.

17.5.3 Emboss

17.5.3.1 Overview

Figure 17.50 Applying example for the Emboss filter



This filter stamps and carves the active layer or selection, giving it relief with bumps and hollows. Bright areas are raised and dark ones are carved. You can vary the lighting.

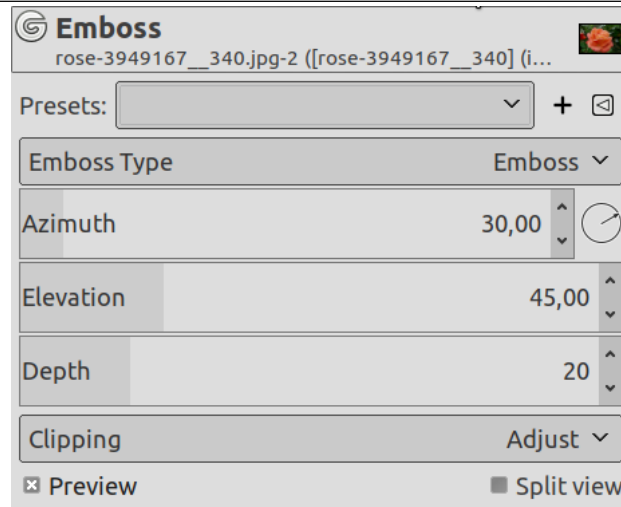
You can use the filter only with RGB images. If your image is grayscale, it will be grayed out in the menu.

17.5.3.2 Starting filter

You can find this filter through Filters → Distorts → Emboss....

17.5.3.3 Options

Figure 17.51 “Emboss” filter options



Presets, Preview, Split view

Note



These options are described in Section [17.2](#).

Function

Bumpmap Relief is smooth and colors are preserved.

Emboss It turns your image to grayscale and relief is more marked, looking like metal.

Emboss Type

Emboss Default: it turns your image to grayscale and relief is more marked, looking like metal. Although the image looks grayscale, it remains a RGB image.

Bumpmap Relief is smooth and colors are preserved.

Azimuth This is about lighting according to the points of the compass (0 - 360). If you suppose South is at the top of your image, then East (0°) is on the left. Increasing value goes counter-clockwise.

Elevation That's height from horizon (0°), in principle up to zenith (90°), but here up to the opposite horizon (180°).

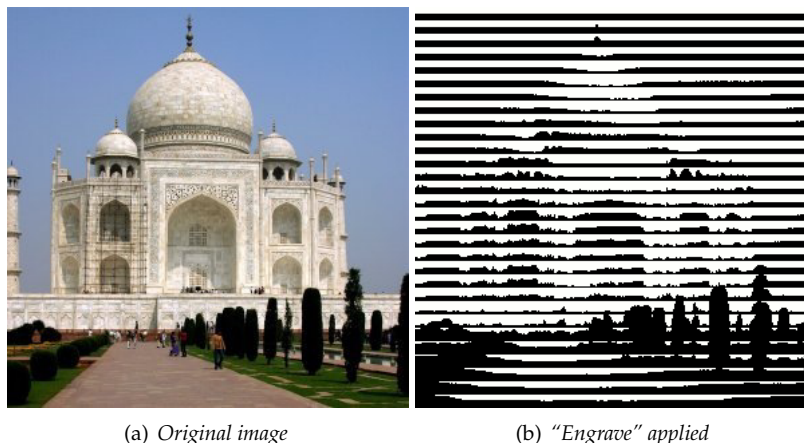
Depth Bumps are higher and hollows deeper when Depth increases.

Clipping The result of this filter can be larger than the original image. With the default Adjust option, the layer will be automatically resized as necessary when the filter is applied. With the Clip option the result will be clipped to the layer boundary.

17.5.4 Engrave

17.5.4.1 Overview

Figure 17.52 Example for the “Engrave” filter



(a) Original image

(b) “Engrave” applied

This filter produces an engraving effect: the image is turned black and white and some horizontal lines of varying height are drawn depending on the value of underlying pixels. The resulting effect reminds of engravings found in coins and old book illustrations.

Note



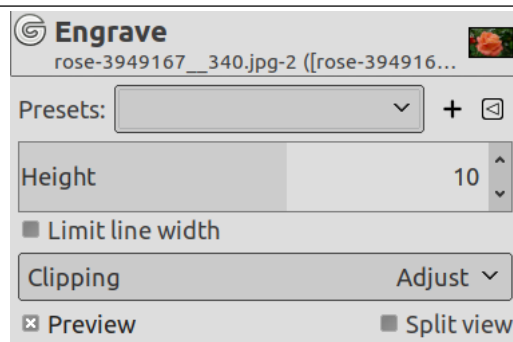
The “Engrave” filter operates only on floating selections and layers with an alpha channel. If the active layer does not have an alpha channel please **add it** first.

17.5.4.2 Activating the filter

This filter is found in the image window menu under Filters → Distorts → Engrave....

17.5.4.3 Options

Figure 17.53 “Engrave” options



Presets, Preview, Split view

Note

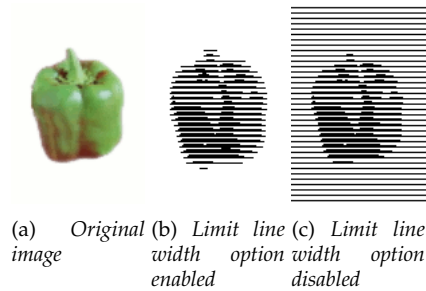


These options are described in Section 17.2.

Height This option specifies the height of the engraving lines. The value goes from 2 to 16.

Limit line width If this option is enabled thin lines are not drawn on contiguous color areas. See the figure below for an example of this option result.

Figure 17.54 Example result of Limit line width option

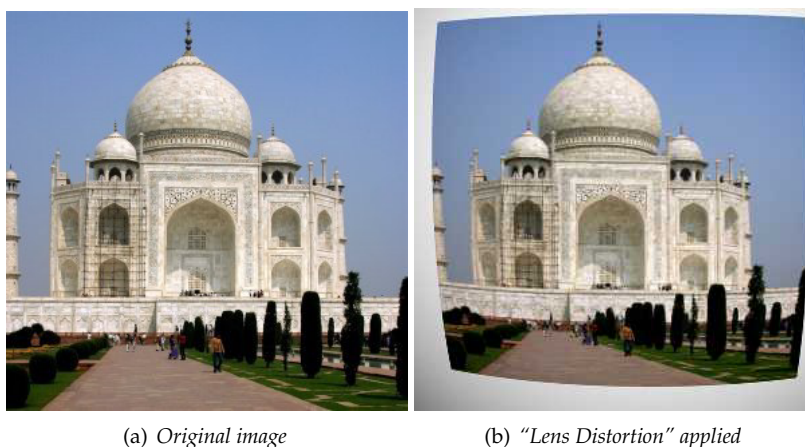


Clipping The result of this filter can be larger than the original image. With the default Adjust option, the layer will be automatically resized as necessary when the filter is applied. With the Clip option the result will be clipped to the layer boundary.

17.5.5 Lens Distortion

17.5.5.1 Overview

Figure 17.55 Example for the “Lens Distortion” filter



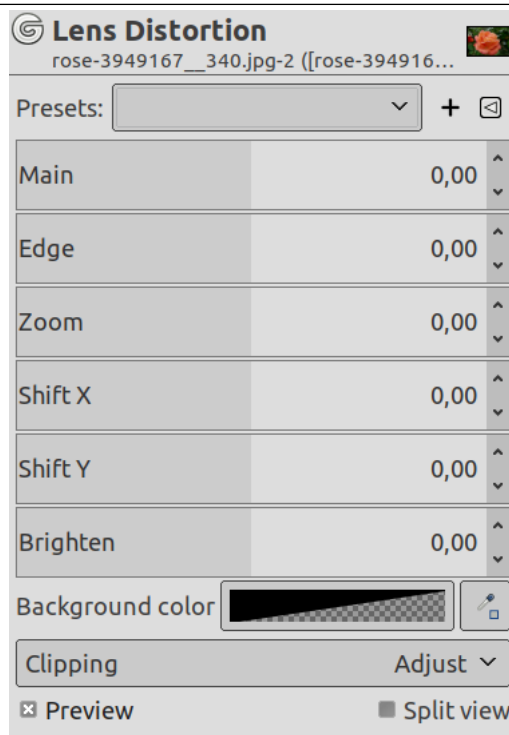
This filter lets you simulate but also correct the typical distortion effect introduced in photo images by the glasses contained in the camera lenses.

17.5.5.2 Activating the filter

This filter is found in the image window menu under Filters → Distorts → Lens Distortion....

17.5.5.3 Options


Figure 17.56 “Lens Distortion” options



The allowed range of all options is from -100.0 to 100.0.

Presets, Preview, Split view

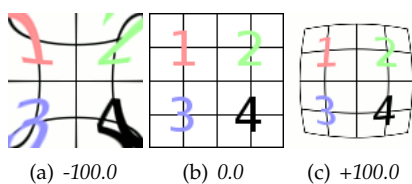
Note



These options are described in Section 17.2.

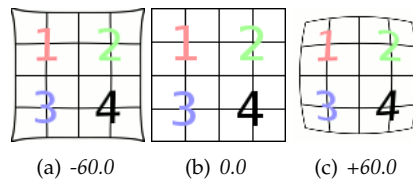
Main The amount of spherical correction to introduce. Positive values make the image convex while negative ones make it concave. The whole effect is similar to wrapping the image inside or outside a sphere.

Figure 17.57 Example result of Main option



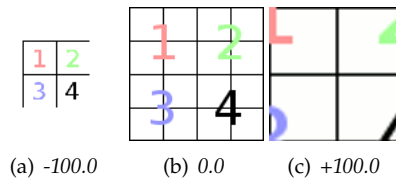
Edge Specifies the amount of additional spherical correction at image edges.

Figure 17.58 Example result of Edge option (Main set to 50.0)



Zoom Specifies the amount of the image enlargement or reduction caused by the hypothetical lens.

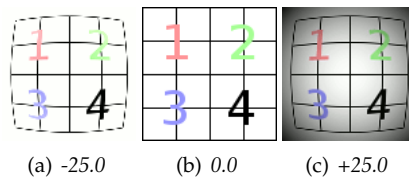
Figure 17.59 Example result of Zoom option



Brighten The amount of the “vignetting” effect: the brightness decrease/increase due to the lens curvature that produces a different light absorption.

The Main or Edge options must be non zero for this option to produce noticeable results.

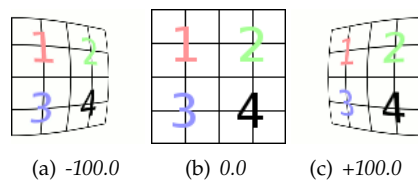
Figure 17.60 Example result of the Brighten option (Main set to 75.0)



Shift X, Shift Y These two options specify the shift of the image produced by not perfectly centered pairs of lenses.

As above this option produces visible results only if the Main or Edge options are non zero.

Figure 17.61 Example result of Shift X option (Main set to 70.0)

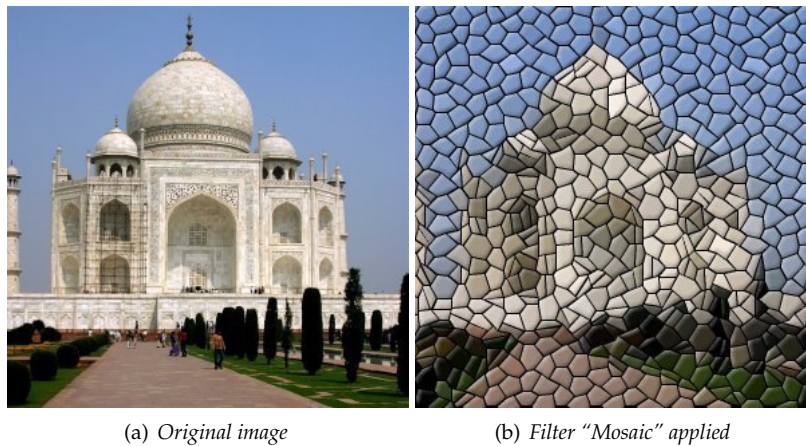


Clipping The result of this filter can be larger than the original image. With the default Adjust option, the layer will be automatically resized as necessary when the filter is applied. With the Clip option the result will be clipped to the layer boundary.

17.5.6 Mosaic

17.5.6.1 Overview

Figure 17.62 Applying example for the “Mosaic” filter



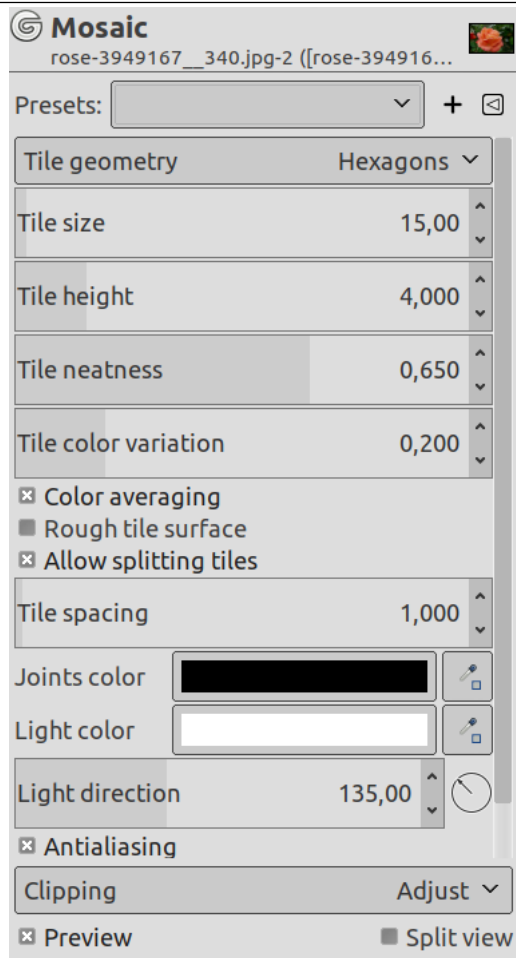
It cuts the active layer or selection into many squares or polygons which are slightly raised and separated by joins, giving so an aspect of mosaic.

17.5.6.2 Activating the filter

You can find this filter through Filters → Distorts → Mosaic...

17.5.6.3 Options

Figure 17.63 “Mosaic” filter options



Presets, Preview, Split view

Note



These options are described in Section [17.2](#).

Tile geometry This option is self-understanding:

Squares Not exactly squares, but 4 edges

Hexagons 6 edges (hexa = 6)

Octagons 8 edges (octa = 8)

Triangles 3 edges (tri = 3)

Tile size Average diameter of each tile (in pixels). Slider and input box allow you to set the size of tile surface (2-1000).

Tile height That's ledge, relief of tiles. Value is width of the lit border in pixels.

Tile neatness When set to 1, most of tiles have the same size. With 0 value, size is determined at random and this may lead to shape variation.

Tile color variation Each tile has only one color. So the number of colors is reduced, compared to the original image. Here you can increase the number of colors a little.

Color averaging When this option is unchecked, the image drawing can be recognized inside tiles. When checked, the colors inside tiles are averaged into a single color.

Rough tile surface With this option tile surface looks pitted.

Allow splitting tiles This option splits tiles in areas with many colors, and so allows a better color gradation and more details in these areas.

Tile spacing That's width of the join between tiles.

Joints/Light color Tiles are lit with the foreground color of the toolbox, and shadow is colored with the background color. Joints have the background color. You can change these colors using the color dwells or the color pickers on the right.

Light direction By default light comes from the upper left corner (135°). You can change this direction from 0 to 360.

Antialiasing This option reduces the stepped aspect that may have borders.

Random seed Filter effect is done at random. You can change seed.

Clipping The result of this filter can be larger than the original image. With the default Adjust option, the layer will be automatically resized as necessary when the filter is applied. With the Clip option the result will be clipped to the layer boundary.

17.5.7 Polar Coordinates

17.5.7.1 Overview

Figure 17.64 Example for Polar Coordinates filter



(a) Original image



(b) "Polar Coordinates" filter applied

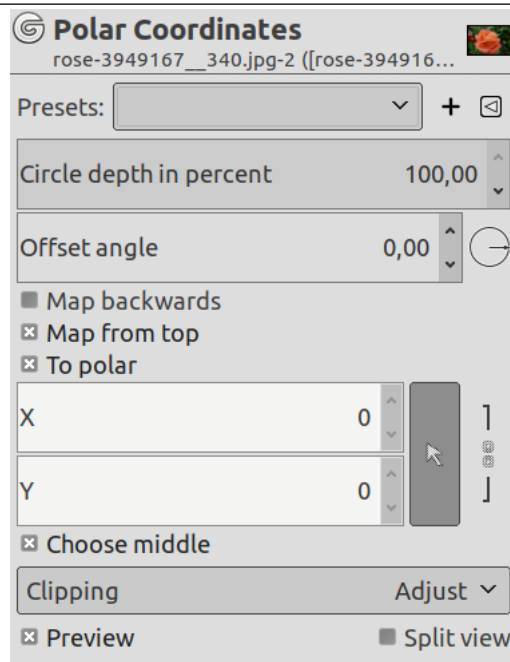
It gives a circular or a rectangular representation of your image with all the possible intermediates between both.

17.5.7.2 Activating the filter

You can find this filter through Filters → Distorts → Polar Coordinates....

17.5.7.3 Options

Figure 17.65 “Polar Coordinates” filter options



Presets, Preview, Split view

Note



These options are described in Section 17.2.

Circle depth in percent Slider and input box allow you to set the “circularity” of the transformation, from rectangle (0%) to circle (100%).

Offset angle This option controls the angle the drawing will start from (0 - 359°), and so turns it around the circle center.

Map backwards When this option is checked, the drawing will start from the right instead of the left.

Map from top If unchecked, the mapping will put the bottom row in the middle and the top row on the outside. If checked, it will be the opposite.

To polar If unchecked, the image will be circularly mapped into a rectangle (odd effect). If checked, the image will be mapped into a circle.

X, Y These polar coordinates are active only if the “Choose middle” option is unchecked.

Choose middle Checked by default: origin center is at the middle of the layer. If unchecked, you can modify X and Y parameters to position the origin center.

Clipping The result of this filter can be larger than the original image. With the default Adjust option, the layer will be automatically resized as necessary when the filter is applied. With the Clip option the result will be clipped to the layer boundary.

17.5.7.4 Examples

Figure 17.66 With text

THE GIMP



If you have just written the text, you must Flatten the image before using the filter.

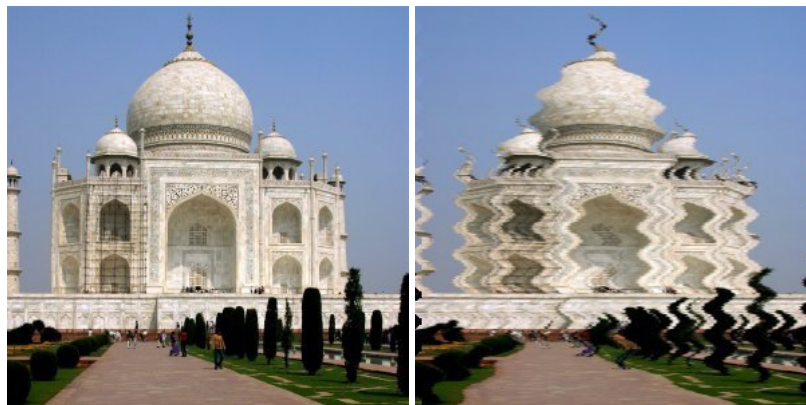
Figure 17.67 With two horizontal bars



17.5.8 Ripple

17.5.8.1 Overview

Figure 17.68 “Ripple” filter example



(a) Original image

(b) Filter “Ripple” applied

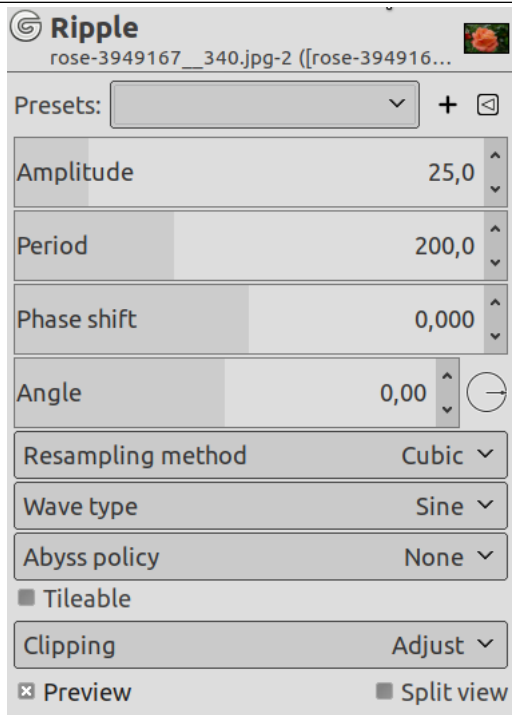
It displaces the pixels of the active layer or selection to waves or ripples reminding a reflection on disturbed water.

17.5.8.2 Activating the filter

You can find this filter through Filters → Distorts → Ripple....


17.5.8.3 Options

Figure 17.69 "Ripple" filter options



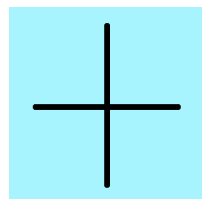
Presets, Preview, Split view

Note

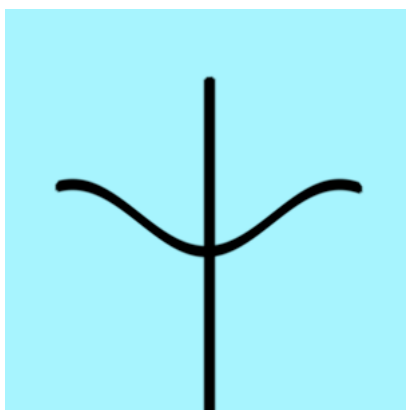


These options are described in Section 17.2.

Original images for examples

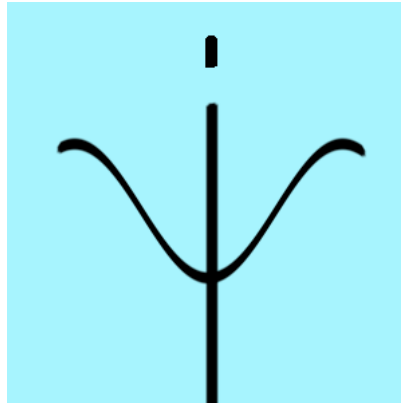


Origin



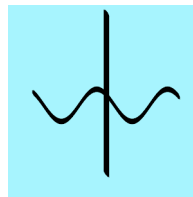
Ripple applied with default options

Amplitude It is related to wave height (0-200 pixels).



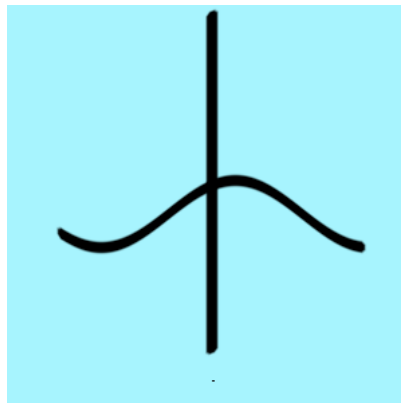
Amplitude = 25

Period It is related to wavelength (0-200 pixels)



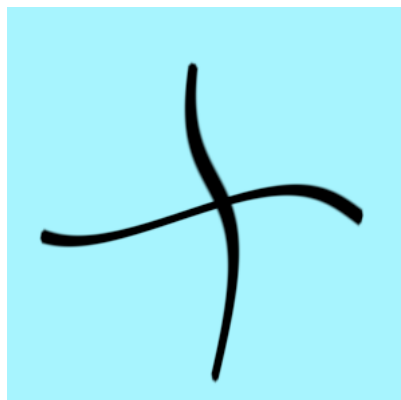
Period = 110

Phase shift Wave is moved



Phase shift = 0.400

Angle Warps wave



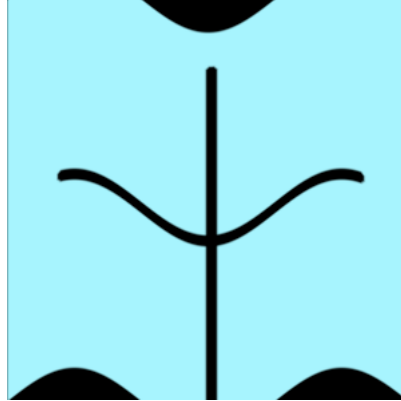
Angle = -40°

Resampling methods These interpolation methods are described in [Interpolation](#).

Wave type Choose how the wave should look like:

- Sawtooth
- Triangle
- Sine

Abyss policy Because ripples cause pixel displacement, some pixels may be missing on the image sides:



Abyss policy = Black

Abyss policy (border management) is treated with **Abyss policy**.

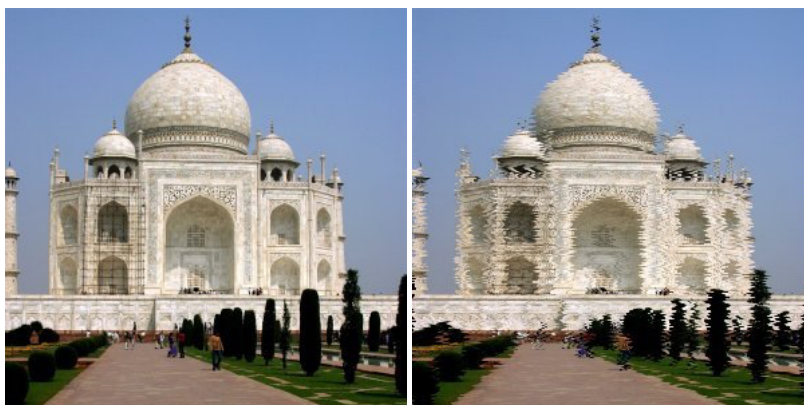
Tileable This preserves the seamless properties if your image is a tile pattern.

Clipping The result of this filter can be larger than the original image. With the default Adjust option, the layer will be automatically resized as necessary when the filter is applied. With the Clip option the result will be clipped to the layer boundary.

17.5.9 Shift

17.5.9.1 Overview

Figure 17.70 Example for the Shift filter



(a) Original image

(b) Filter "Shift" applied

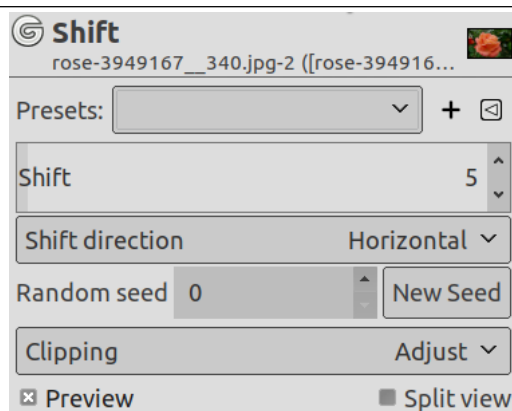
It shifts all pixel rows, horizontally or vertically, in the current layer or selection, on a random distance and within determined limits.

17.5.9.2 Activating the filter

You can find this filter through Filters → Distorts → Shift...

17.5.9.3 Options

Figure 17.71 “Shift” filter options



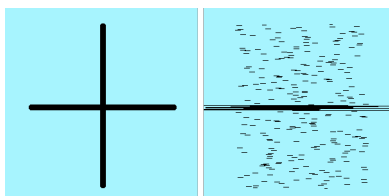
Presets, Preview, Split view

Note



These options are described in Section [17.2](#).

Shift With this option, you can set the maximum shift, between 1 and 200 pixels.



Left: original.....Right: shift = 100 horizontally

Shift direction This option sets the direction horizontally or vertically.

Random seed Shift is done at random. You can change the seed.

Clipping The result of this filter can be larger than the original image. With the default Adjust option, the layer will be automatically resized as necessary when the filter is applied. With the Clip option the result will be clipped to the layer boundary.

17.5.10 Spherize

17.5.10.1 Overview

This filter creates a kind of bubble whose size is that of the image or selection, as if the content was wrapped around a sphere.

Figure 17.72 Spherize filter example, with default values

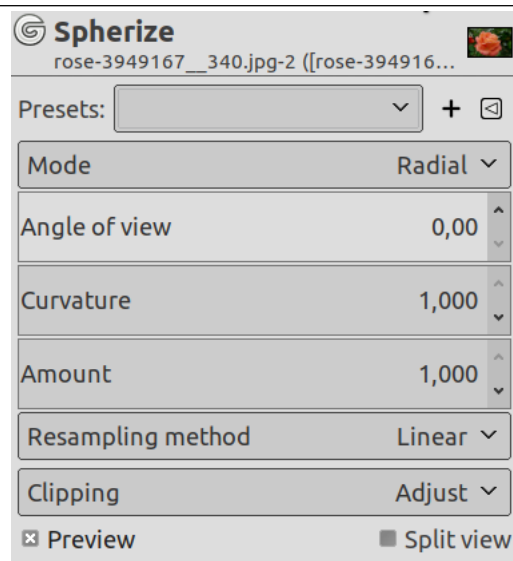
(a) Original image

(b) "Spherize" filter applied

17.5.10.2 Starting filter

You can find this filter through Filters → Distorts → Spherize...

17.5.10.3 Options

Figure 17.73 "Spherize" filter options

Presets, Preview, Split view

Note



These options are described in Section [17.2](#).

Mode

- **Radial** is the default mode. See example above.
- **Horizontal**: as if image was mapped on a vertical cylinder.



- **Vertical:** as if image was mapped on a horizontal cylinder.

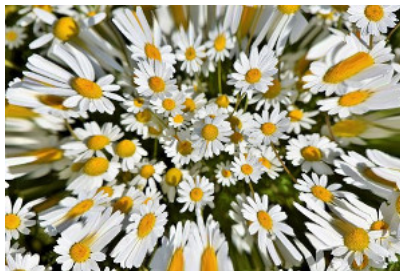
Angle of view Camera angle of view (0 - 180°)



Curvature Spherical cap angle, as a fraction of the co-angle (complement angle) of view. Result is less domed as curvature decreases (100% - 0).



Amount Interesting for negative values, which result in a hollow instead of a bump (from 1.000 to -1.000).

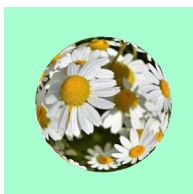


Resampling methods These interpolation methods are described in [Interpolation](#).

Clipping The result of this filter can be larger than the original image. With the default Adjust option, the layer will be automatically resized as necessary when the filter is applied. With the Clip option the result will be clipped to the layer boundary.

17.5.10.4 Using Spherize filter

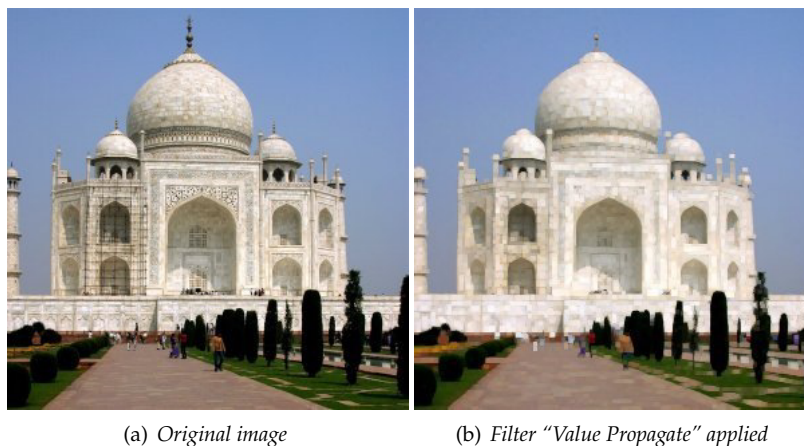
Drawing a selection before applying filter allows you to create another shape, such as a sphere: select Ellipse tool with the Fixed option checked; draw a circle; apply Spherize filter with the Use the selection as input selected. Invert selection and fill it with wanted background.



17.5.11 Value Propagate

17.5.11.1 Overview

Figure 17.74 Example for the Value Propagate filter



(a) Original image

(b) Filter "Value Propagate" applied

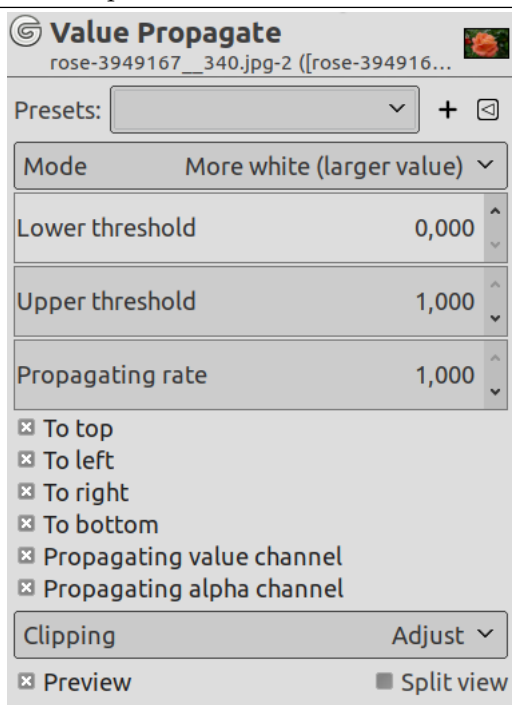
This filter works on color borders. It spreads pixels that differ in a specified way from their neighboring pixels.

17.5.11.2 Activating the filter

This filter is found in the image window menu under Filters → Distorts → Value Propagate...

17.5.11.3 Options

Figure 17.75 "Value propagate" filter options



Presets, Preview, Split view**Note**

These options are described in Section 17.2.

Mode The examples will be about the following image:



More white (larger value) Pixels will be propagated from upper value pixels towards lower value pixels. So bright areas will enlarge.

Figure 17.76 More white



Bright pixels have been propagated to dark pixels in the four directions : top, bottom, right and left. Filter applied several times to increase effect.

More black (smaller value) Pixels will be propagated from lower value pixels towards upper value pixels. So dark areas will enlarge.

Figure 17.77 More black



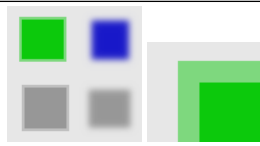
Figure 17.78 To bottom only



The same as above with To bottom direction only checked.

Middle value to peaks On a border between the selected thresholds, the average of both values is propagated.

Figure 17.79 Middle value to peaks



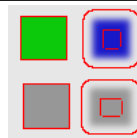
(a) A thin border with a transitional color has been added (one pixel to objects. It is not visible around objects with smoothed borders.

(b) Green area zoomed x800. A thin border has been added. Its value is the average between grey (90%) and green (78%): $(90 + 78) / 2 = 84$.

Color to peaks The propagated areas will be filled with the foreground color of the toolbox.

A color selector opens, with a color picker.

Figure 17.80 Color to peaks



In this example, the selected color is Red. A thin border, one pixel wide, red, is added around objects. With smoothed objects, this border is located at the furthest limit of smoothing. Here, another border appears inside. This is an artifact due to the small size of the object which makes the smoothing area of opposite sides to overlap.

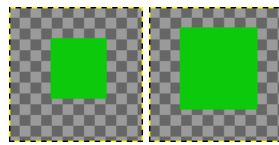
Only color Only areas with the selected color will propagate. With this option, soft and fuzzy edges don't propagate well.

Figure 17.81 Only color



In this example, the selected color is that of the green object. After applying filter several times, the green area is clearly enlarged.

More opaque, More transparent These commands work like "More white" and "More black". Opaque (transparent) areas will be propagated over less opaque (transparent) areas. These commands need an image with an alpha channel.

Figure 17.82 More opaque

(a) Original layer, with a transparent background. (b) Filter applied several times: the green, opaque, area got increased.

Lower threshold, Upper threshold A pixel will be propagated (spread) if the difference in value between the pixel and its neighbour is no smaller than the lower threshold and no larger than the upper threshold.

Propagating rate That's the propagating amount. The higher it will be the more colored the propagation will be.

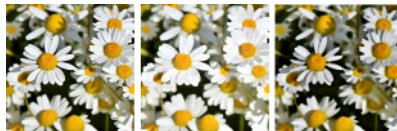
To top, To left, To right, To bottom You can select one or more directions.

Propagating value channel If checked, the pixel's color channels (gray channel on grayscale images) will be propagated. The option is checked by default, of course.

Propagating alpha channel If checked, the pixel alpha value will be propagated, otherwise the pixel will get the alpha of the neighboring pixels.

Clipping The result of this filter can be larger than the original image. With the default Adjust option, the layer will be automatically resized as necessary when the filter is applied. With the Clip option the result will be clipped to the layer boundary.

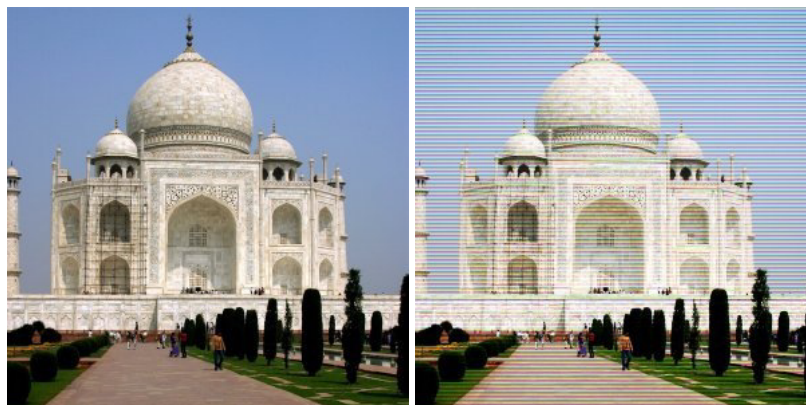
17.5.11.4 Using Value Propagate



Left: Original.....Middle: More white.....Right: More black

17.5.12 Video

17.5.12.1 Overview

Figure 17.83 Applying example for the "Video Degradation" filter

(a) Original image

(b) Filter "Video Degradation" applied

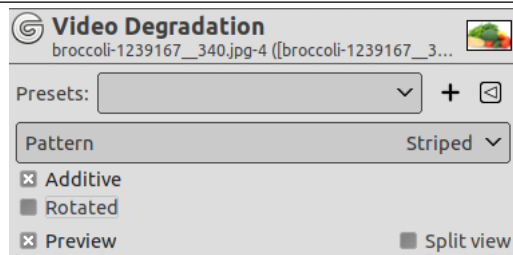
Apply low dot-pitch RGB simulation to the specified drawable.

17.5.12.2 Activating the filter

You can find this filter through Filters → Distorts → Video Degradation....

17.5.12.3 Options

Figure 17.84 “Video” filter options



Presets, Preview, Split view

Note



These options are described in Section 17.2.

Pattern It would be rather difficult to describe what each pattern will render. It’s best to see what they render in the Preview.

Additive Set whether the function adds the result to the original image.

Rotated Rotate the result by 90°.

17.5.13 Waves

17.5.13.1 Overview

Figure 17.85 Example for the Waves filter



(a) Original image

(b) Filter “Waves” applied with default options and period = 20.0

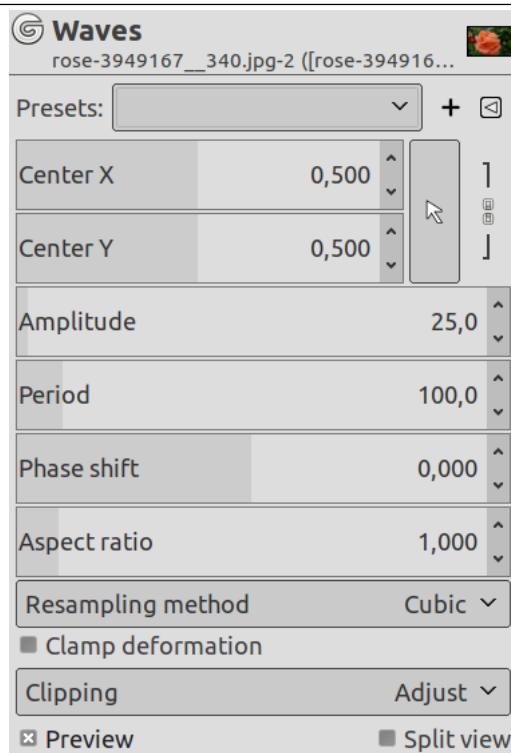
With this filter you get the same effect as a stone thrown in a quiet pond, giving concentric waves.

17.5.13.2 Activating the filter

You can find this filter through Filters → Distorts → Waves....

17.5.13.3 Options

Figure 17.86 “Waves” filter options



Presets, Preview, Split view

Note



These options are described in Section 17.2.

Center X, Center Y Move the center of the waves

Amplitude Varies the height of the waves.

Period That is wavelength. Varies the distance between the top of waves.

The high default value suits large images. For images of some hundreds pixels wide and high, a lower value, such as 20 in our example, fits better.

Phase shift This command shifts the top of the ripple.

Aspect ratio Values less than 1.00 render waves oval, with major axis vertical. Values higher than 1.00 give a major axis horizontal.

Resampling method These interpolation methods are described in [Interpolation](#).

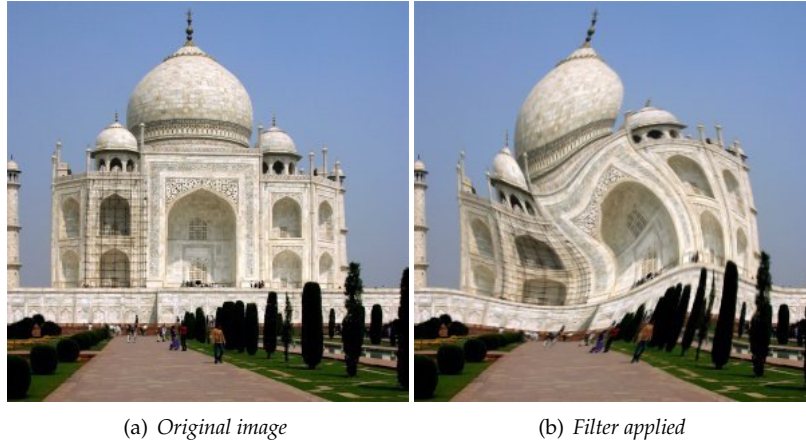
Clamp deformation TODO.

Clipping The result of this filter can be larger than the original image. With the default Adjust option, the layer will be automatically resized as necessary when the filter is applied. With the Clip option the result will be clipped to the layer boundary.

17.5.14 Whirl and Pinch

17.5.14.1 Overview

Figure 17.87 Example for the Whirl and Pinch filter



“Whirl and Pinch” distorts your image in a concentric way.

“Whirl” (applying a non-zero Whirl angle) distorts the image much like the little whirlpool that appears when you empty your bath.

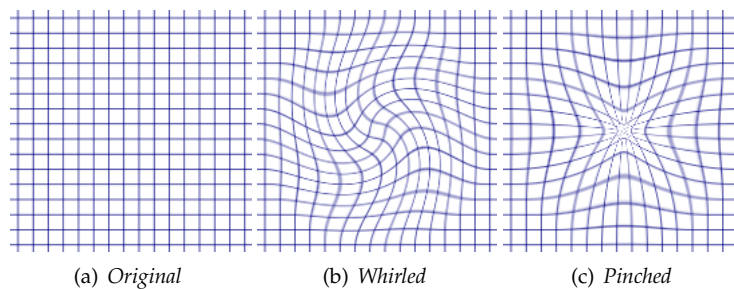
“Pinch”, with a nil rotation, can be compared to applying your image to a soft rubber surface and squeezing the edges or corners. If the Pinch amount slider is set to a negative value, it will look as if someone tried to push a round object up toward you from behind the rubber skin. If the Pinch amount is set to a positive value, it looks like someone is dragging or sucking on the surface from behind, and away from you.

Tip



The “pinch” effect can sometimes be used to compensate for image distortion produced by telephoto or fish-eye lenses (“barrel distortion”).

Figure 17.88 Illustration

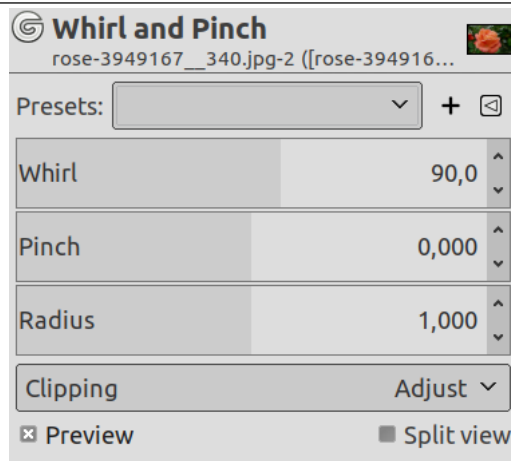


17.5.14.2 Activating the filter

You can find this filter through Filters → Distorts → Whirl and Pinch...

17.5.14.3 Parameter Settings

Figure 17.89 “Whirl and Pinch” filter options



Presets, Preview, Split view

Note



These options are described in Section 17.2.

Whirl angle Clockwise or counter clockwise (-360 to +360). Controls how many degrees the affected part of the image is rotated.

Pinch amount Whirlpool depth(-1 to +1). Determines how strongly the affected part of the image is pinched.

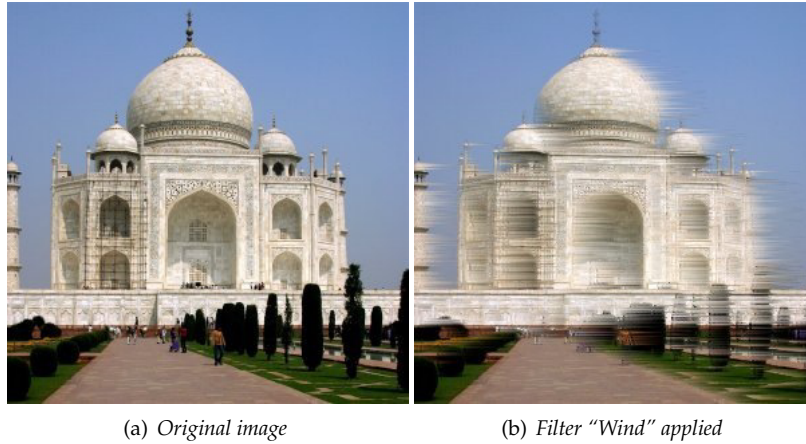
Radius Whirlpool width (0.0-2.0). Determines how much of the image is affected by the distortion. If you set *Radius* to 2, the entire image will be affected. If you set *Radius* to 1, half the image will be affected. If *Radius* is set to 0, nothing will be affected (think of it as the radius in a circle with 0 in the center and 1 halfway out).

Clipping The result of this filter can be larger than the original image. With the default Adjust option, the layer will be automatically resized as necessary when the filter is applied. With the Clip option the result will be clipped to the layer boundary.

17.5.15 Wind

17.5.15.1 Overview

Figure 17.90 “Wind” filter example



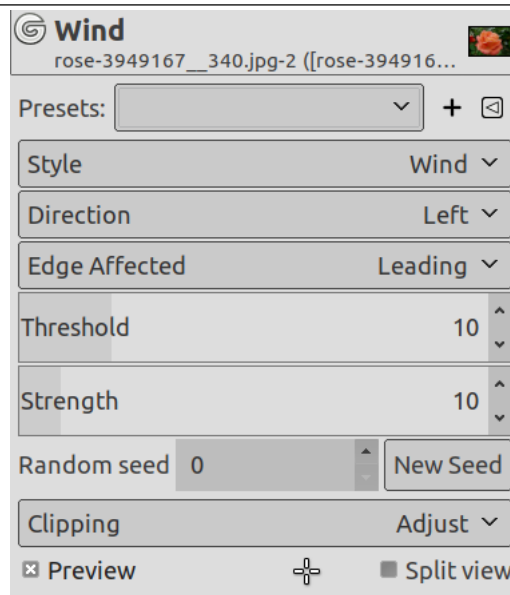
The Wind filter can be used to create motion blur, but it can also be used as a general distort filter. What is characteristic about this filter is that it will render thin black or white lines. Wind will detect the edges in the image, and stretch out thin white or black lines from that edge. This is why you can create the illusion of motion, because the edges are what will be blurred in a photograph of a moving object.

17.5.15.2 Activating the filter

You can find this filter through Filters → Distorts → Wind....

17.5.15.3 Options

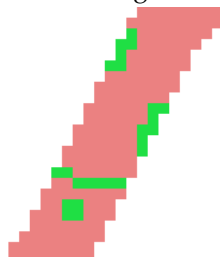
Figure 17.91 “Wind” filter options



The interface is quite simple. You can set the *Strength* of the wind and a *Threshold* value. *Threshold* will restrict the effect to fewer areas of the image. *Strength* controls the amount of wind, so a high value will render a storm. You can also increase the effect by setting the *Style* to Blast, which will produce thicker lines than Wind.

You can only set the wind in two directions, either Left or Right. However, you can control which edge the wind will come from using the values Leading, Trailing or Both. Because Trailing will produce a black wind, it creates a less convincing motion blur than Leading, which will produce white wind.

The following illustrations are based on this image:



Presets, Preview, Split view

Note

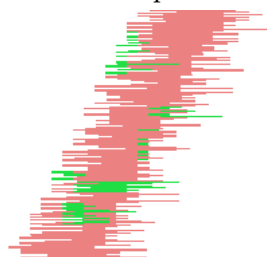


These options are described in Section [17.2](#).

Style

Wind This option is the most suggestive of a moving effect. Trails are thin.

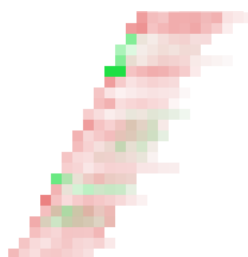
Blast This option tries to suggest a blast due to an explosion. Trails are thick.



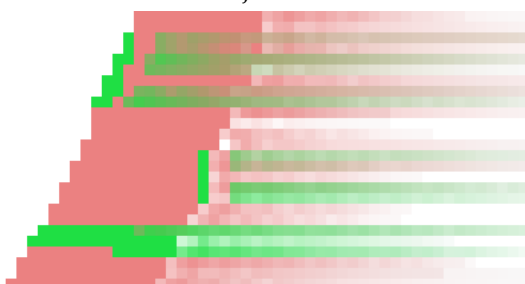
Direction You can select the direction, Left or Right, from which the wind comes.

Edge Affected

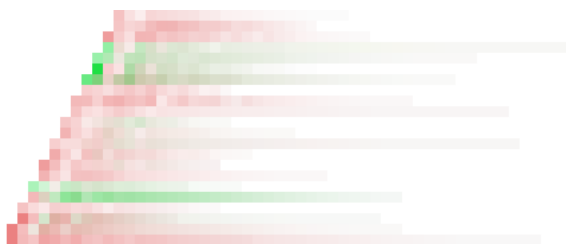
Leading Trails will start from the front border, falling on the object itself. It suggests that a violent wind is pulling color out.



Trailing Trails start from the back border of the object.



Both Combines both effects.



Threshold The threshold to detect borders. The higher it is, the fewer borders will be detected.

Strength Higher values increase the strength of the effect.

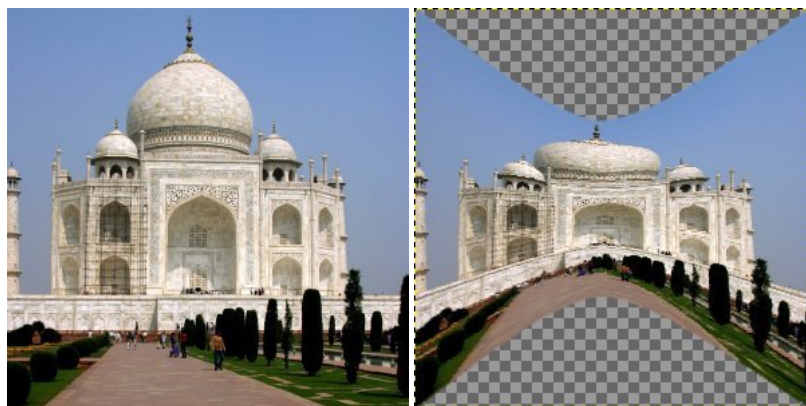
Random seed The Wind effect is done at random. You can use another seed.

Clipping The result of this filter can be larger than the original image. With the default Adjust option, the layer will be automatically resized as necessary when the filter is applied. With the Clip option the result will be clipped to the layer boundary.

17.5.16 Curve Bend

17.5.16.1 Overview

Figure 17.92 Applying example for the Curve Bend filter



(a) Original image

(b) Filter "Curve Bend" applied

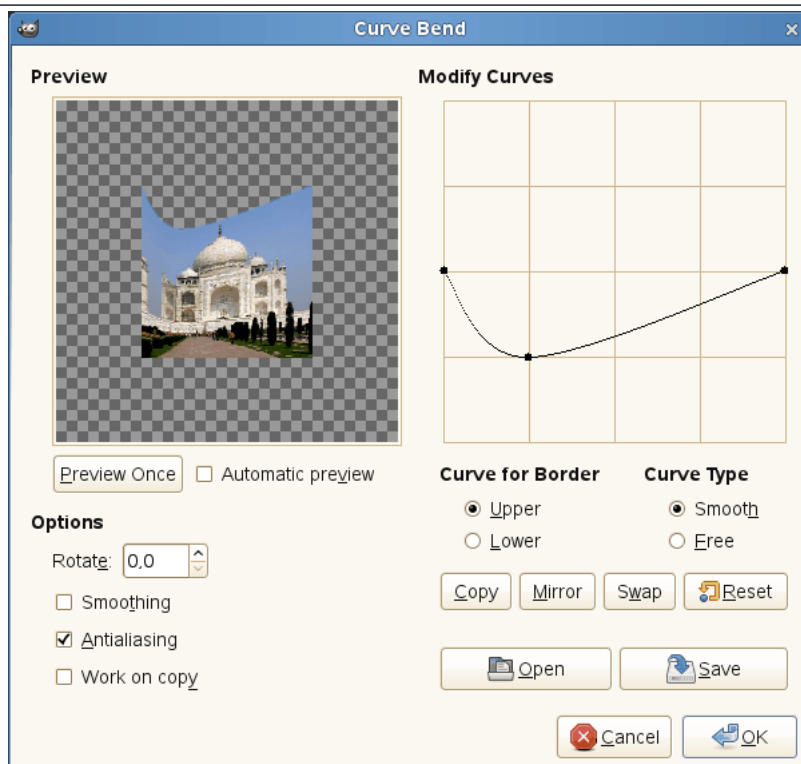
This filter allows you to create a curve that will be used to distort the active layer or selection. The distortion is applied gradually from an image or selection border to the other.

17.5.16.2 Activating the filter

You can find this filter through Filters → Distorts → Curve Bend....

17.5.16.3 Options

Figure 17.93 “Curve bend” filter options



Preview The preview displays changes to image or selection without modifying the image until you press *OK*.

Preview once This button allows you to update the preview each time you need it.

Automatic Preview With this option, preview is changed in real time. This needs much calculation and may lengthen work. It is particularly evident when using “Rotation”.

Options

Rotate There, you can set the application angle of filter (0-360 counter-clockwise). 0 is default setting: The curve will be applied from the upper border and/or from the lower. Set to 90, it will be applied from left border and/or from the right one.

Smoothing, Antialiasing The distort process may create hard and stepped borders. These two options improve this aspect.

Work on copy This option creates a new layer called “Curve_bend_dummy_layer_b” which becomes the active layer, allowing you to see changes to your image in normal size without modifying the original image until you press the *OK* button.

Modify Curves In this grid, you have a marked horizontal line, with a node at both ends, which represents by default the upper border of image. If you click on this curve, a new node appears, that you can drag to modify the curve as you want. You can create several nodes on the curve.

You can have only two curves on the grid, one for the so named “upper” border and the other for the so named “lower” border. You can activate one of them by checking the *Upper* or *Lower* radio button.

If you use the *Free Curve Type* option, the curve you draw will replace the active curve.

Curve for Border There you can select whether the active curve must be applied to the *Upper* or the *Lower* border, according to the rotation.

Caution

Remember that the curve border depends on the rotation. For example, with Rotate = 90° the upper curve will actually be applied to the left border.

Curve Type With the Smooth, you get automatically a well rounded curve when you drag a node.

The Free option allows you to draw a curve freely. It will replace the active curve.

Buttons

Copy Copy the active curve to the other border.

Mirror Mirror the active curve to the other border.

Swap Swap the Upper and Lower curves.

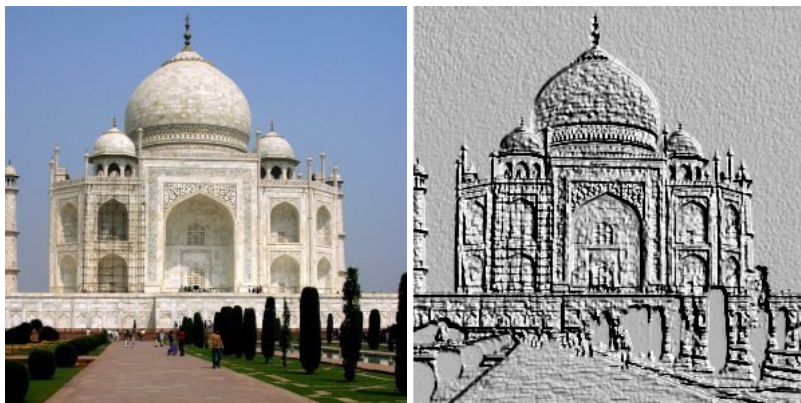
Reset Reset the active curve.

Open Load the curve from a file.

Save Save the curve to a file.

17.5.17 Emboss (legacy)**17.5.17.1 Overview**

Figure 17.94 Applying example for the Emboss (legacy) filter



(a) Original image

(b) Filter "Emboss (legacy)" applied

This filter stamps and carves the active layer or selection, giving it relief with bumps and hollows. Bright areas are raised and dark ones are carved. You can vary the lighting.

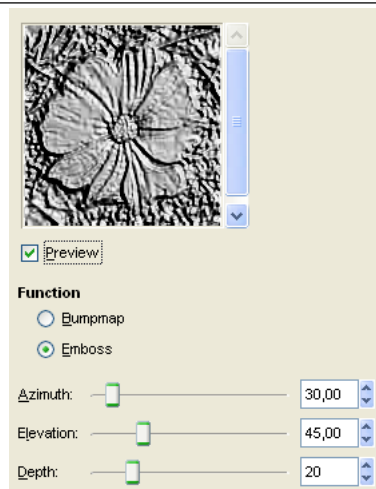
You can use the filter only with RGB images. If your image is grayscale, it will be grayed out in the menu.

17.5.17.2 Starting filter

You can find this filter through Filters → Distorts → Emboss (legacy)...

17.5.17.3 Options

Figure 17.95 “Emboss (legacy)” filter options



Preview All your setting changes will appear in the Preview without affecting the image until you click on OK. Don't keep Preview checked if your computer is too slow.

Function

Bumpmap Relief is smooth and colors are preserved.

Emboss It turns your image to grayscale and relief is more marked, looking like metal.

Azimuth This is about lighting according to the points of the compass (0 - 360). If you suppose South is at the top of your image, then East (0°) is on the left. Increasing value goes counter-clockwise.

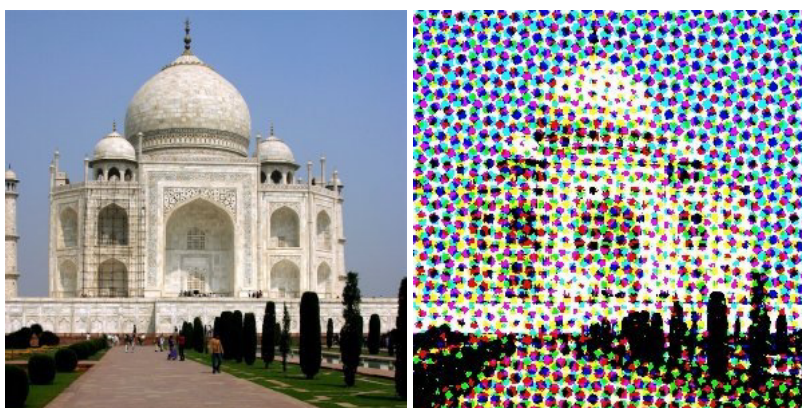
Elevation That's height from horizon (0°), in principle up to zenith (90°), but here up to the opposite horizon (180°).

Depth Bumps are higher and hollows deeper when Depth increases.

17.5.18 Newsprint

17.5.18.1 Overview

Figure 17.96 Applying example for the Newsprint filter



(a) Original image

(b) Filter “Newsprint” applied

This filter halftones the image using a clustered-dot dither. Halftoning is the process of rendering an image with multiple levels of grey or color (i.e. a continuous tone image) on a device with fewer tones; often a bi-level device such as a printer or typesetter.

The basic premise is to trade off resolution for greater apparent tone depth (this is known as spatial dithering).

There are many approaches to this, the simplest of which is to throw away the low-order bits of tone information; this is what the posterize filter does. Unfortunately, the results don't look too good. However, no spatial resolution is lost.

This filter uses a clustered-dot ordered dither, which reduces the resolution of the image by converting cells into spots which grow or shrink according to the intensity that cell needs to represent.

Imagine a grid super-imposed on the original image. The image is divided into cells by the grid - each cell will ultimately hold a single spot made up of multiple output pixels in order to approximate the darkness of the original image in that cell.

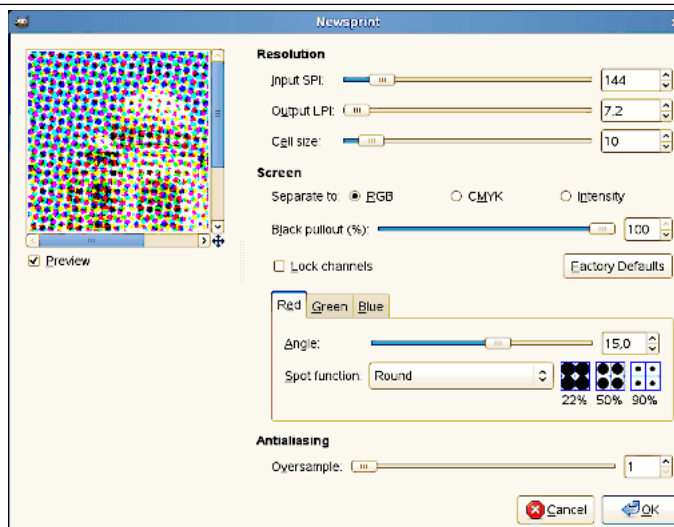
Obviously, a large cell size results in a heavy loss in resolution! The spots in the cells typically start off as circles, and grow to be diamond shaped. This change in shape is controlled by a Spot function. By using different spot functions, the evolution in the shape of the spots as the cell goes from fully black to fully white may be controlled.

17.5.18.2 Starting filter

You can find this filter through Filters → Distorts → Newspaper....

17.5.18.3 Options

Figure 17.97 "Newsprint" filter options



Preview All your setting changes will appear in the Preview without affecting the image until you click on OK. Note that the preview displays only a part of the whole image if the filter is applied to an selection. Don't keep Preview checked if your computer is too slow.

Resolution This group controls the cell size, either by setting the input and output resolutions, or directly.

Input SPI Resolution of the original input image, in Samples Per Inch (SPI). This is automatically initialised to the input image's resolution.

Output LPI Desired output resolution, in Lines Per Inch (LPI).

Cell size Resulting cell size, in pixels. Most often you will want to set this directly.

Screen

Separate To RGB, CMYK, Intensity Select which colorspace you wish to operate in. In *RGB* mode, no colorspace conversion is performed. In *CMYK*, the image is first internally converted to *CMYK*, then each color channel is separately halftoned, before finally being recombined back to an *RGB* image. In *Intensity* mode, the image is internally converted to grayscale, halftoned, then the result used as the alpha channel for the input image. This is good for special effects, but requires a little experimentation to achieve best results. Hint: try *CMYK* if you don't know which to go for initially.

Black pullout (%) When doing *RGB*->*CMYK* conversion, how much *K* (black) should be used?

Lock channels Make channel modifications apply to all channels.

Factory Defaults Restore the default settings which should give pleasing results.

Angle Cell grid angle for this channel.

Spot function Spot function to be used for this channel (see preview in blue cell-boxes).

Antialiasing Proper halftoning does not need antialiasing: the aim is to reduce the color depth after all! However, since this plugin is mainly for special effects, the results are displayed on screen rather than by a black/white printer. So it is often useful to apply a little anti-aliasing to simulate ink smearing on paper. If you do want to print the resulting image then set the antialiasing to 1 (i.e., off).

Oversample Number of subpixels to sample to produce each output pixel. Set to 1 to disable this feature. Warning: large numbers here will lead to very long filter runtimes!

17.5.18.4 Example

Figure 17.98 Example for Newsprint

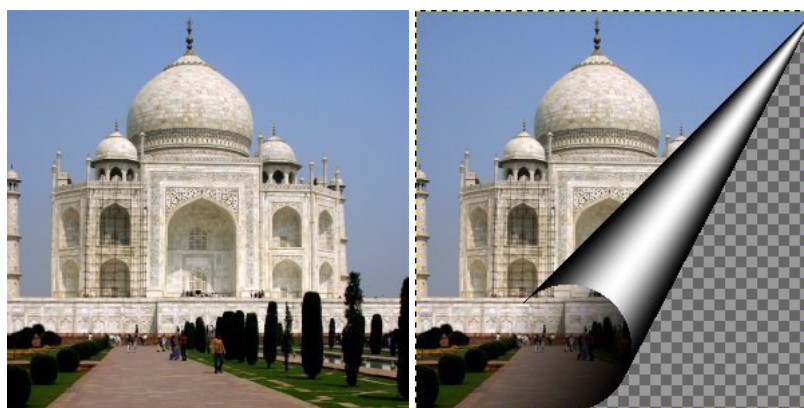


An example from plug-in author

17.5.19 Page Curl

17.5.19.1 Overview

Figure 17.99 Example for the Page Curl filter



(a) Original image

(b) Filter "Page Curl" applied

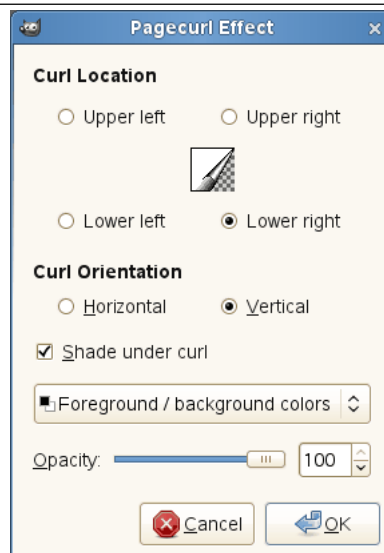
This filter curls a corner of the current layer or selection into a kind of cornet showing the underlying layer in the cleared area. A new “Curl Layer” and a new Alpha channel are created. The part of the initial layer corresponding to this cleared area is also transparent.

17.5.19.2 Activating the filter

This filter is found in the image window menu under Filters → Distorts → Page Curl....

17.5.19.3 Options

Figure 17.100 Options



Curl Location You have there four radio buttons to select the corner you want raise. The Preview is redundant and doesn't respond to other options.

Curl Orientation *Horizontal* and *Vertical* refer to the border you want raise.

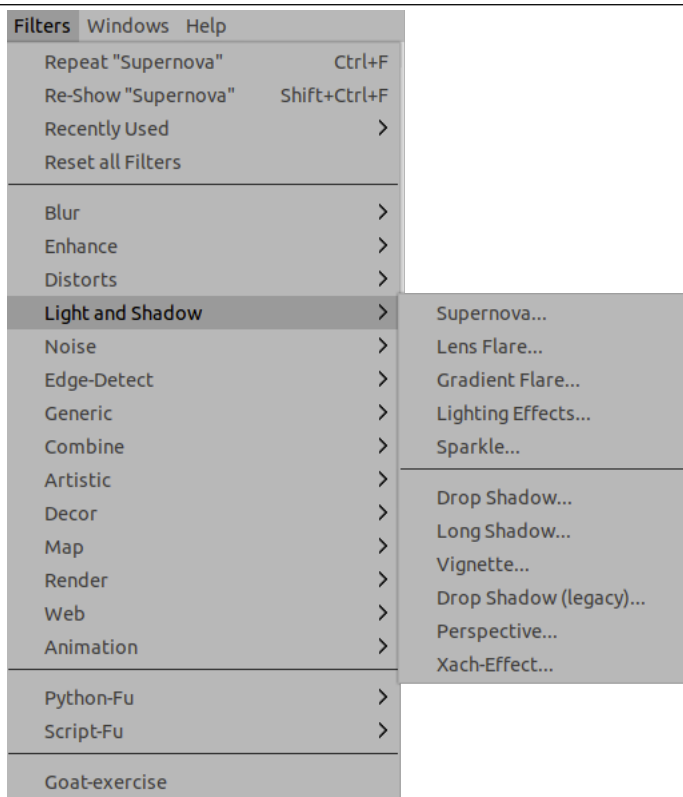
Shade under curl This is the shadow inside the cornet.

Foreground / background colors, Current gradient, Current gradient (reversed) This option refers to the outer face of the cornet.

Opacity Refers to the visibility of the layer part underlying the cornet. It may be set also in the Layer Dialog.

17.6 Light and Shadow Filters

Figure 17.101 The Light and Shadow filters menu



17.6.1 Introduction

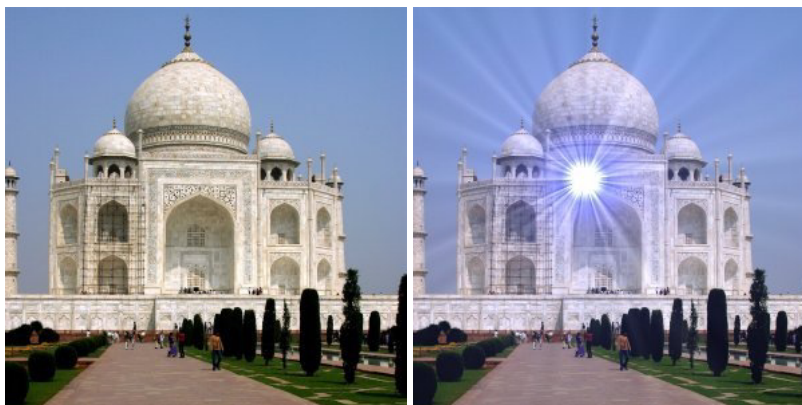
Here you will find two groups of filters:

- for light effects filters, which render several illumination effects of the image.
- for shadow effect filters, which create various kinds of shadows.

17.6.2 Supernova

17.6.2.1 Overview

Figure 17.102 Applying example for the Supernova filter



(a) Original image

(b) Filter "Supernova" applied

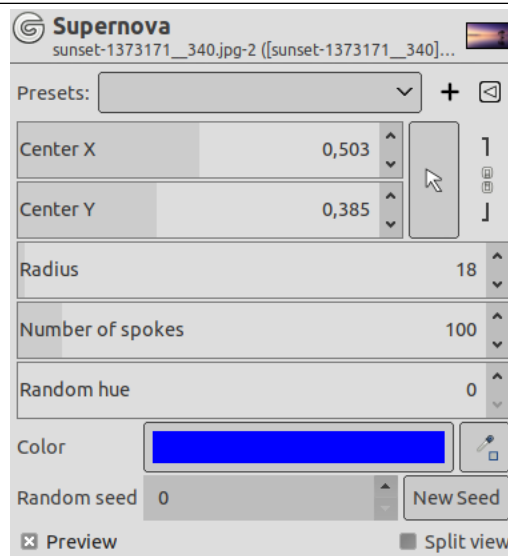
This filter creates a big star reminding a super-nova. It works with RGB and GRAY images. Light effect decreases according to $1/r$ where r is the distance from star center.

17.6.2.2 Activate the filter

This filter is found in the image window menu under Filters → Light and Shadow → Supernova....

17.6.2.3 Options

Figure 17.103 “Supernova” filter options



Presets, Preview, Split view

Note



These options are described in Section [17.2](#).

Center X, Center Y You can use input boxes to set horizontal (X) and vertical (Y) coordinates of Supernova center. You can also click and drag the supernova center in preview.

Radius This is radius of the Supernova center: the upper limit seems to be unlimited. When you increase the value, you increase the number of central white pixels according to $r*r$ (1, 4, 9...).

Radius is represented by a horizontal line in preview, with a cross at end. You can click and drag this cross to set radius.

Number of spokes This is number of rays (1-1024). Each pixel in the nova center emit one pixel wide rays. All these rays are more or less superimposed resulting in this glittering effect you get when you move this slider.

Random hue Color rays at random. (0-360) value seems to be a range in HSV color circle.

Color When you click on the color swatch, you bring up the usual color selector.

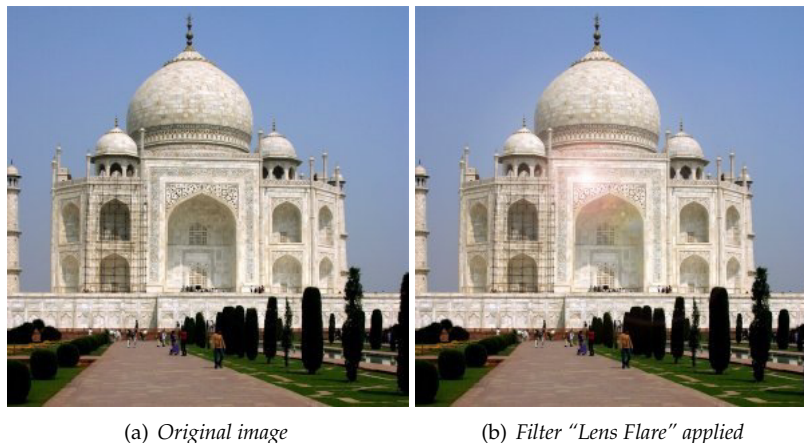
You also have a color picker. When it is selected, the mouse pointer goes with a square on image: it's the color sample whose size you can modify in the GEGL operation window under Toolbox.

Random seed Filter effect is made at random. You can change seed.

17.6.3 Lens Flare

17.6.3.1 Overview

Figure 17.104 Example for the Lens Flare filter



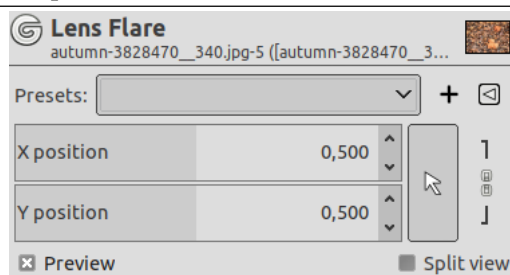
This filter gives the impression that sun hit the objective when taking a shot. You have not the possibilities that the **Gradient Flare** filter offers.

17.6.3.2 Activate the filter

You can find this filter in the image menu menu through Filters → Light and Shadow → Lens Flare.

17.6.3.3 Options

Figure 17.105 "Lens Flare" filter options



Presets, Preview, Split view

Note



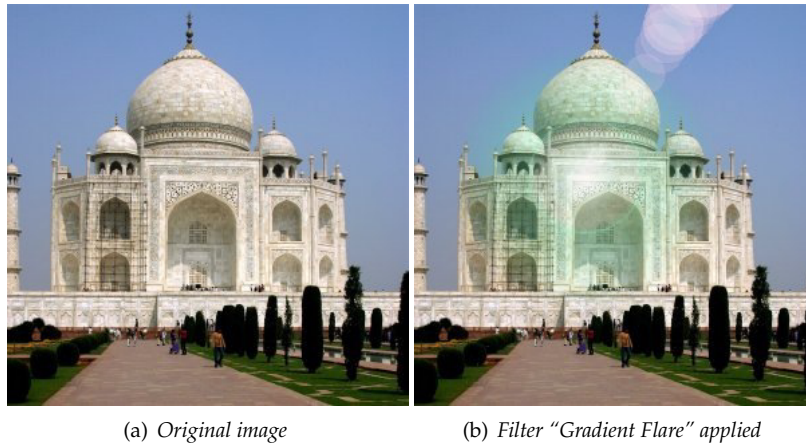
These options are described in Section 17.2.

X position, Y position You can set X and Y coordinates of glint using the input box. The coordinate origin is at the upper left corner. Position is ratio of the image dimension (0.500 is the middle, 1.000 the right or bottom border; it can be set outside of the canvas).

17.6.4 Gradient Flare

17.6.4.1 Overview

Figure 17.106 Example for the Gradient Flare filter



Gradient Flare effect reminds the effect you get when you take a photograph of a blinding light source, with a halo and radiations around the source. The Gradient Flare image has three components: *Glow* which is the big central fireball, *Rays* and *Second Flares*

17.6.4.2 Activating the filter

This filter is found in the image window menu under Filters → Light and Shadow → Gradient Flare...

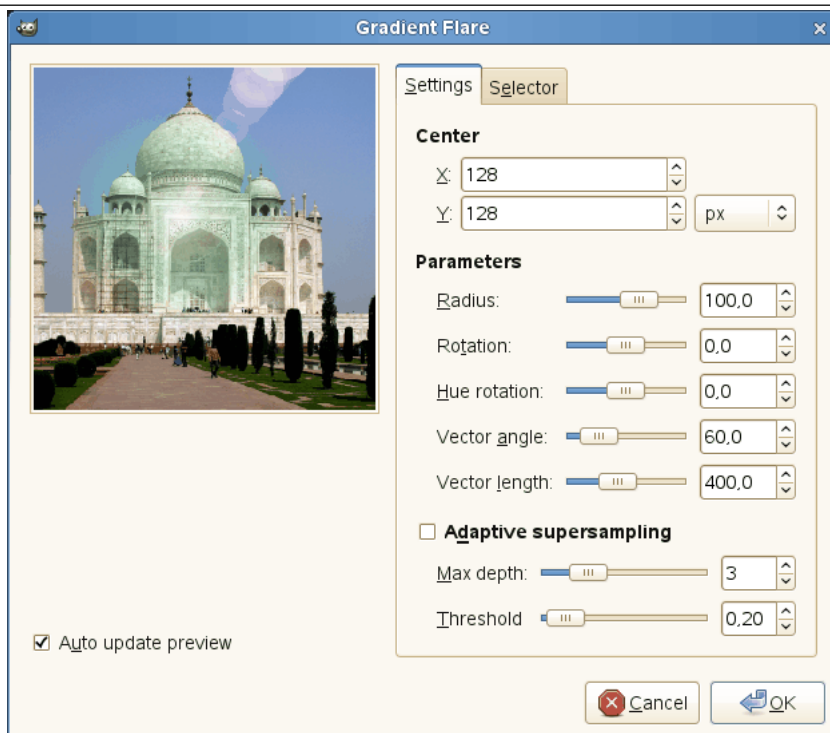
17.6.4.3 Options

The *Settings* tab allows you to set manually the parameters while the *Selector* tab let you choose presets in a list.

Preview When Auto update preview is checked, parameter setting results are interactively displayed in preview without modifying the image until you click on OK button.

17.6.4.3.1 Settings

Figure 17.107 “Gradient Flare” filter options (Settings)



Center You can set X and Y (pixels) coordinates of glint using the input box or by clicking into the preview. The coordinate origin is at the upper left corner.

Parameters

Radius The radius of the effect. The slider limits the range of possible values, but using the input box you can enter greater values.

Rotation Turn the effect.

Hue rotation Change the tint (color) of the effect.

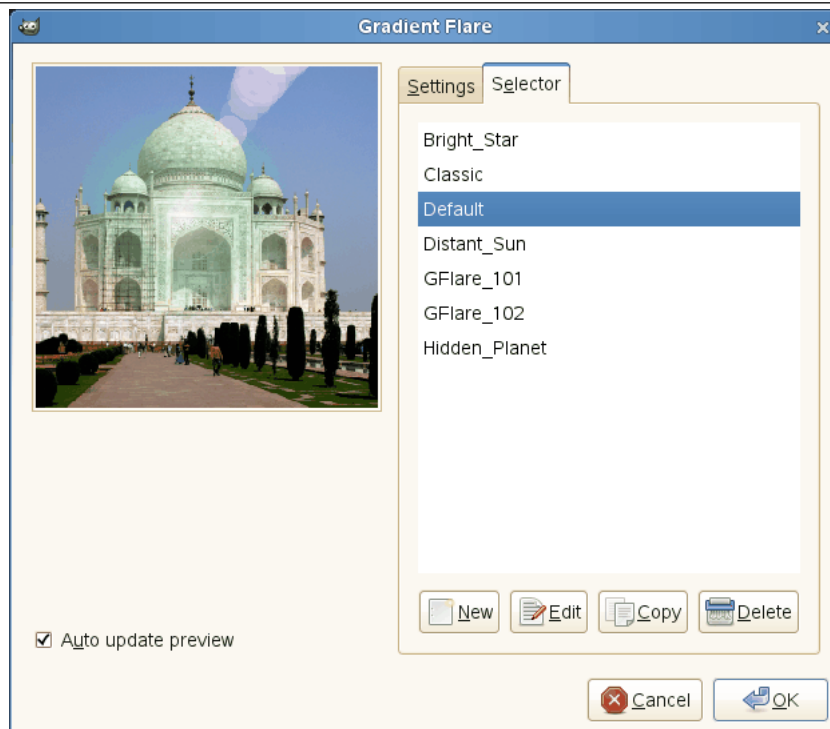
Vector angle Turn the Second flares.

Vector length Vary the distance applied for the Second flares.

Adaptive supersampling Settings of the anti-aliasing following parameters like Depth and Threshold. (See also *Supersampling* .)

17.6.4.3.2 Selector

Figure 17.108 “Gradient Flare” filter options (Selector)



The Selector tab allows you to select a Gradient Flare pattern, to change it and save it.

New When you click on this button, you create a new Gradient Flare pattern. Give it a name of your choice.

Edit This button brings up the **Gradient Flare Editor** (see below).

Copy This button allows you to duplicate selected Gradient Flare pattern. You can edit the copy without altering the original.

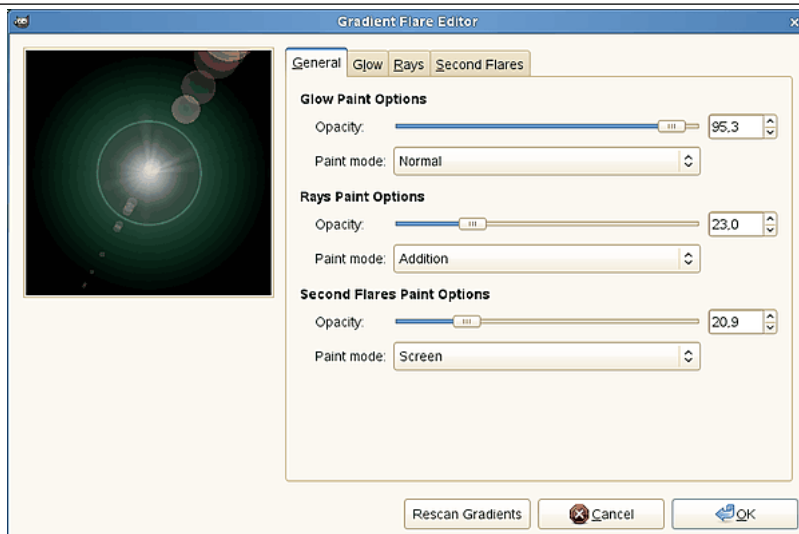
Delete This button deletes the selected Gradient Flare pattern.

17.6.4.4 Gradient Flare Editor

The Gradient Flare Editor is also organized in tabs:

17.6.4.4.1 General

Figure 17.109 “Gradient Flare Editor” options (General)



Glow Paint Options

Opacity Slider and input box allows you to reduce glow opacity (0-100).

Paint mode You can choose between four modes:

Normal In this mode, the glow covers the image without taking into account what is beneath.

Addition Pixel RGB values of glow are added to RGB values of the corresponding pixels in the image. Colors get lighter and white areas may appear.

Overlay Light/Dark areas of glow enhance corresponding light/dark areas of image.

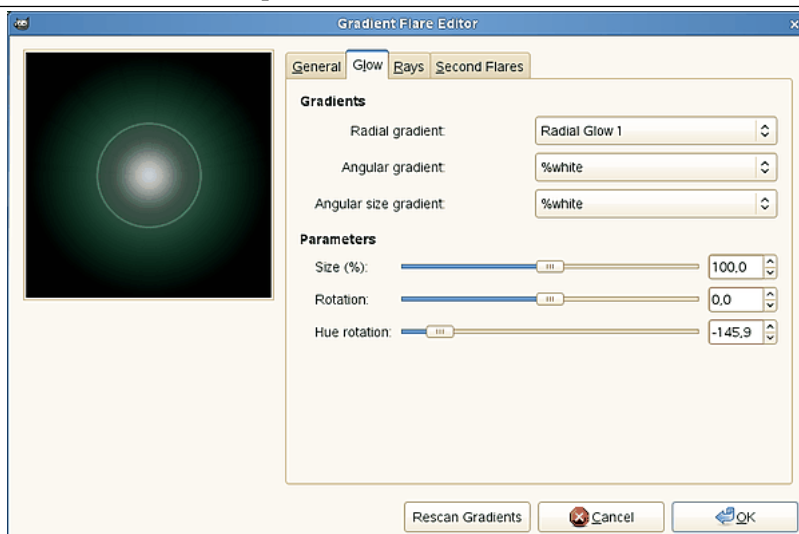
Screen Dark areas of image are enlightened by corresponding light areas of glow. Imagine two slides projected onto the same screen.

Rays Paint Options Options are the same as for Glow Paint Options.

Second Flare Paint Options Options are the same as for Glow Paint Options.

17.6.4.4.2 Glow

Figure 17.110 “Gradient Flare Editor” options (Glow)



Gradients By clicking on the rectangular buttons, you can develop a long list of gradients. “%” gradients belong to the Editor.

Radial gradient The selected gradient is drawn radially, from center to edge.

Angular gradient The selected gradient develops around center, counter-clockwise, starting from three o’clock if the Rotation parameter is set to 0. Radial and angular gradients are combined according to the Multiply mode: light areas are enhanced and colors are mixed according to CMYK color system (that of your printer).

Angular size gradient This is a gradient of radius size which develops angularly. Radius is controlled according to gradient Luminosity: if luminosity is zero (black), the radius is 0%. If luminosity is 100% (white), the radius is also 100%.

Parameters

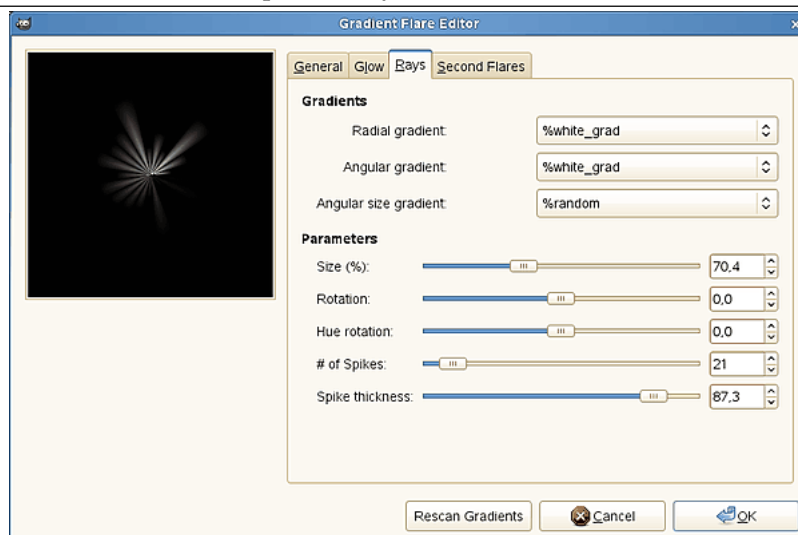
Size (%) Sets size of glow in percent (0-200).

Rotation Sets the origin of the angular gradient (-180 +180).

Hue rotation Sets glow color, according to the HSV color circle (-180 +180). (Cf. [The triangle color selector](#).)

17.6.4.4.3 Rays

Figure 17.111 “Gradient Flare Editor” options (Rays)



Gradients The options are the same as for [Glow](#).

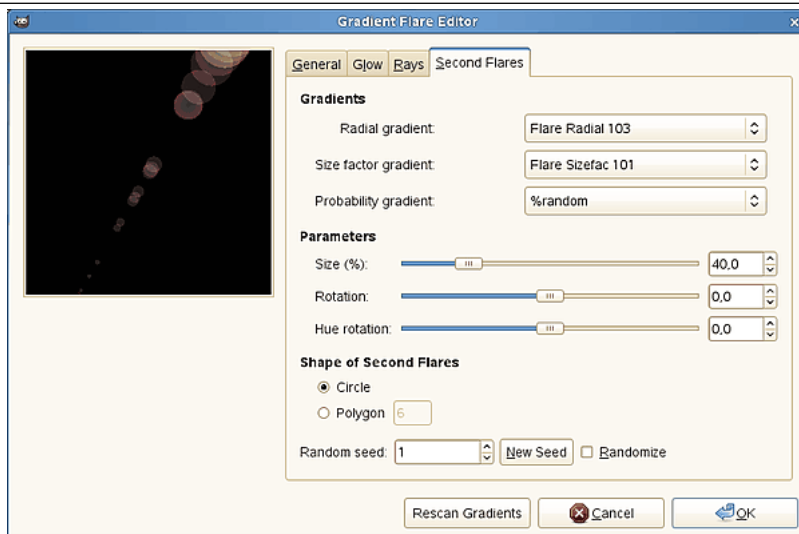
Parameters The first three options are the same as in [Glow](#). Two are new:

of Spikes This option determines the number of spikes (1-300) but also their texture.

Spike thickness When spikes get wider (1-100), they look like flower petals.

17.6.4.4.4 Second Flares

Figure 17.112 “Gradient Flare Editor” options (Second Flares)



Gradients The options are the same as for **Glow**.

Parameters Options are the same as in **Glow**.

Shape of Second Flares Second flares, these satellites of the main flare, may have two shapes: Circle and Polygon. You can set the *Number* polygon sides. The option accepts 1 side (!), not 2.

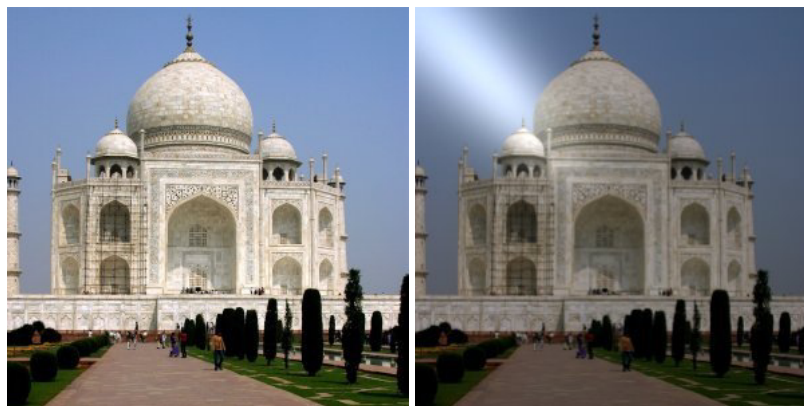
Random seed The random generator will use this value as a seed to generate random numbers. You can use the same value to repeat the same “random” sequence several times.

Randomize When you click on this button, you produce a random seed that will be used by the random generator. It is each time different.

17.6.5 Lighting Effects

17.6.5.1 Overview

Figure 17.113 The same image, before and after applying Lighting filter



(a) Original image

(b) Filter “Lighting Effects” applied

This filter simulates the effect you get when you light up a wall with a spot. It doesn’t produce any drop shadows and, of course, doesn’t reveal any new details in dark zones.

17.6.5.2 Activate the filter

This filter is found in the image window menu under Filters → Light and Shadow → Lighting Effects....

17.6.5.3 Options

Figure 17.114 “Lighting” filter options



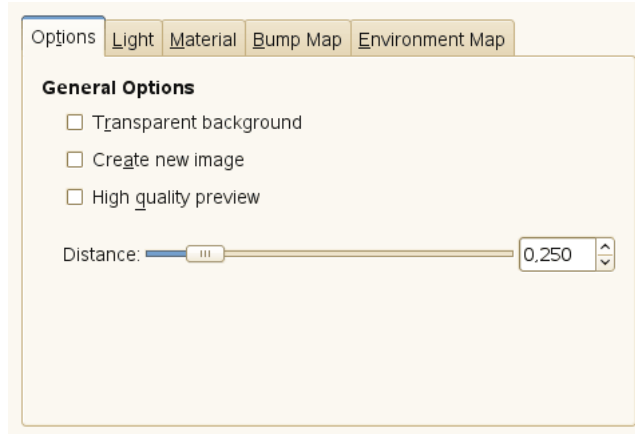
Preview When Interactive is checked, parameter setting results are interactively displayed in preview without modifying the image until you click on OK button.

If Interactive is not checked, changes are displayed in preview only when you click on the Update button. This option is useful with a slow computer.

Any other options are organized in tabs:

17.6.5.3.1 General Options

Figure 17.115 “Lighting” filter options (General Options)



Transparent background Makes destination image transparent when bumpmap height is zero (height is zero in black areas of the bumpmapped image).

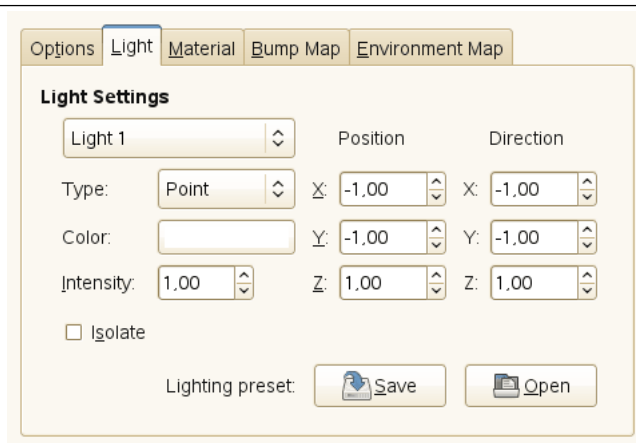
Create new image Creates a new image when applying filter.

High quality preview For quick CPU...

Distance You can specify the distance of the light source from the center of the image with this slider. The range of values is from 0.0 to 2.0.

17.6.5.3.2 Light Settings

Figure 17.116 “Lighting” filter options (Light Settings)



In this tab, you can set light parameters. With Light 1 ... Light 6 you can create six light sources and work on each of them separately.

Type The filter provides several *light types* in a drop-down list:

Point Displays a blue point at center of preview. You can click and drag it to move light all over the preview.

Directional The blue point is linked to preview center by a line which indicates the direction of light.

None This deletes the light source (light may persist...).

Color When you click on the color swatch, you bring a dialog up where you can select the light source color.

Intensity With this option, you can set light intensity.

Position Determines the light point position according to three coordinates: X coordinate for horizontal position, Y for vertical position, Z for source distance (the light darkens when distance increases). Values are from -1 to +1.

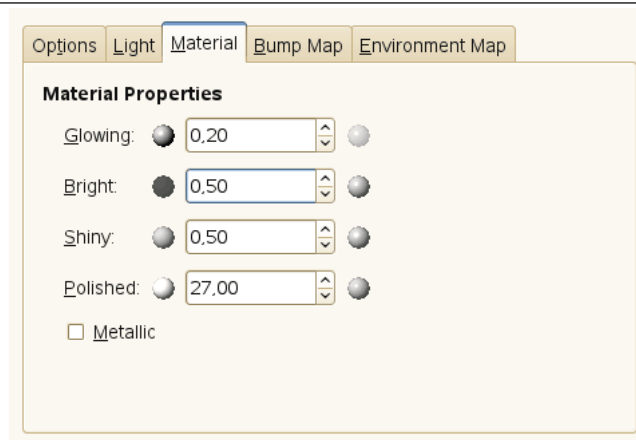
Direction This option should allow you to fix the light direction in its three X, Y and Z coordinates.

Isolate With this option, you can decide whether all light sources must appear in the Preview, or only the source you are working on.

Lighting preset You can save your settings with the Save and get them back later with the Open.

17.6.5.3.3 Material Properties

Figure 17.117 “Lighting” filter options (Material Properties)



These options don't concern light itself, but light reflected by objects.

Small spheres, on both ends of the input boxes, represent the action of every option, from its minimum (on the left) to its maximum (on the right). Help pop ups are more useful.

Glowing With these option, you can set the amount of original color to show where no direct light falls.

Bright With this option, you can set the intensity of original color when hit directly by a light source.

Shiny This option controls how intense the highlight will be.

Polished With this option, higher values make the highlight more focused.

Metallic When this option is checked, surfaces look metallic.

17.6.5.3.4 Bump Map

Figure 17.118 “Lighting” filter options (Bump Map)



In this tab, you can set filter options that give relief to the image. See *Bump mapping* .

Enable bump mapping With this option, bright parts of the image will appear raised and dark parts will appear depressed. The aspect depends on the light source position.

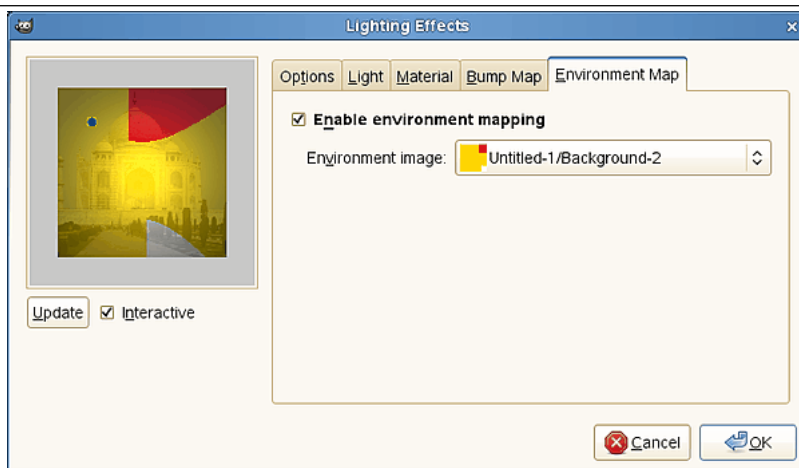
Bumpmap image You have to select there the grey-scale image that will act as a bump map. See **Bump Map** plug-in for additional explanations.

Curve This option defines the method that will be used when applying the bump map; that is, the bump height is a function of the specified curve. Four curve types are available: *Linear*, *Logarithmic*, *Sinusoidal* and *Spherical*.

Maximum height This is the maximum height of bumps.

17.6.5.3.5 Environment Map

Figure 17.119 “Lighting” filter options (Environment Map)



Enable environment mapping When you check this box, the following option is enabled:

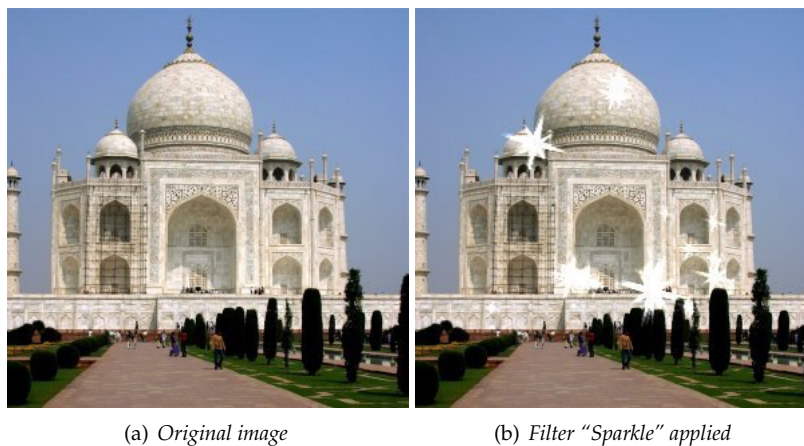
Environment image You have to select there a RGB image, present on your screen. Please note that for this option to work you should load another image with GIMP *before* using it.

An example can be found at [[BUDIG01](#)].

17.6.6 Sparkle

17.6.6.1 Overview

Figure 17.120 Applying example for the Sparkle filter



(a) Original image

(b) Filter “Sparkle” applied

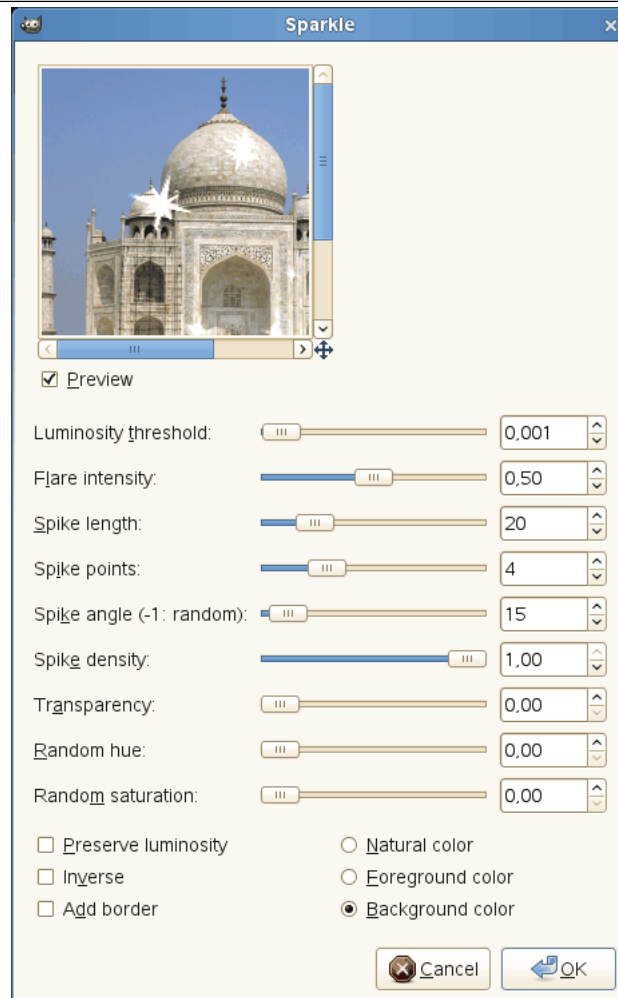
This filter adds sparkles to your image. It uses the lightest points according to a threshold you have determined. It is difficult to foresee where sparkles will appear. But you can put white points on your image where you want sparkles to be.

17.6.6.2 Activate the filter

This filter is found in the image window menu under Filters → Light and Shadow → Sparkle....

17.6.6.3 Parameter Settings

Figure 17.121 “Sparkle” filter options



Sliders and input boxes allow you to set values.

Preview If checked, parameter setting results are interactively displayed in preview. Scroll bars allow you to move around the image.

Luminosity threshold The higher the threshold, the more areas are concerned by sparkling (0.0-0.1).

Flare intensity When this value increases, the central spot and rays widen (0.0-1.0).

Spike length This is ray length (1-100). When you reduce it, small spikes decrease first.

Spike points Number of starting points for spikes (0-16). It's the number of big spikes. There is the same number of small spikes. When number is odd, small spikes are opposite the big ones. When number is even, big spikes are opposite another big spike.

Spike angle This is angle of first big spike with horizontal (-1 +360). -1 determines this value at random. If a spot has several pixels within required threshold, each of them will generate a sparkle. If angle is positive, they will all be superimposed. With -1, each sparkle will have a random rotation resulting in numerous thin spikes.

Spike density This option determines the number of sparkles on your image. It indicates the percentage (0.0-1.0) of all possible sparkles that will be preserved.

Transparency When you increase transparency (0.0-1.0), sparkles become more transparent and the layer beneath becomes visible. If there is no other layer, sparkle saturation decreases.

Random hue This option should change sparkle hue at random... (0.0-1.0).

Random saturation This option should change sparkle saturation at random... (0.0-1.0).

Preserve luminosity Gives to all central pixels the luminosity of the brightest pixel, resulting in increasing the whole sparkle luminosity.

Inverse Instead of selecting brightest pixels in image, Sparkle will select the darkest ones, resulting in dark sparkles.

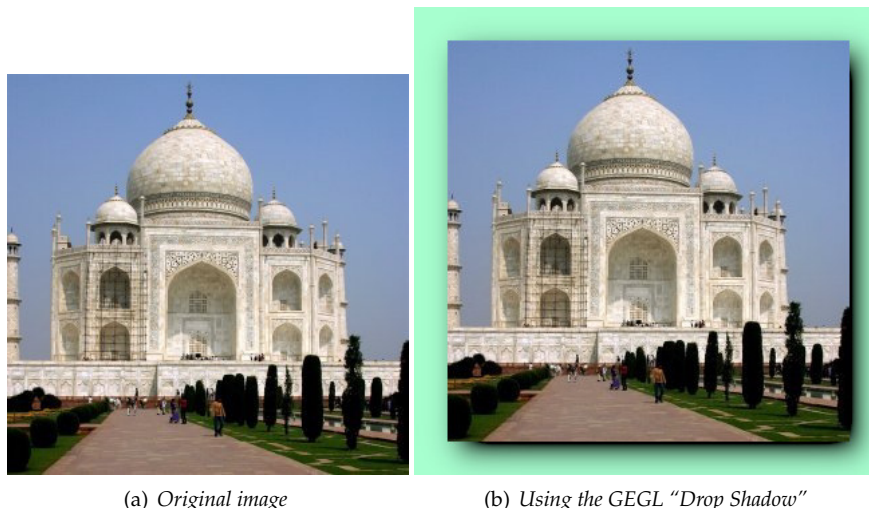
Add border Instead of creating sparkles on brightest pixels, this option creates an image border made up of numerous sparkles.

Natural color, Foreground color, Background color You can change there the color of central pixels. This color will be added in Screen mode (Multiply if Inverse is checked). “Natural color” is the color of the pixel in the image.

17.6.7 Drop Shadow

17.6.7.1 Overview

Figure 17.122 Example for the “Drop Shadow” filter



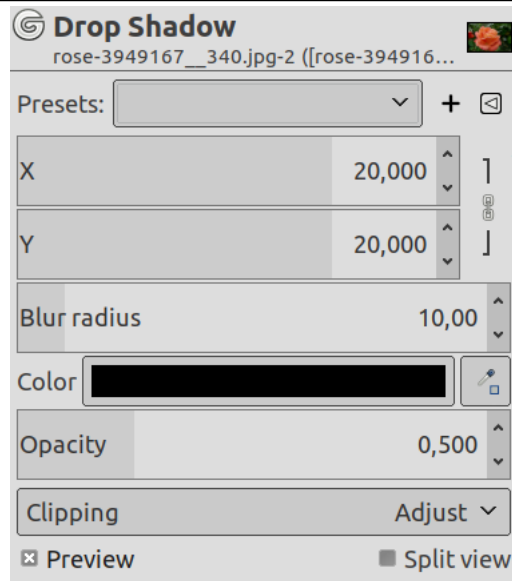
With this GEGL filter you can add a drop-shadow to an image, a selection or a text. You may choose the color, position, and size of the shadow.

17.6.7.2 Activate the filter

You can find this filter in the image menu menu through Filters → Light and Shadow → Drop Shadow.... This filter is normally disabled. You must add an Alpha channel to your image to use it.

17.6.7.3 Options

Figure 17.123 “Drop Shadow” filter options



Presets, Preview, Split view

Note



These options are described in Section [17.2](#).

X, Y The layer containing the drop shadow will be moved horizontally by X pixels, vertically by Y pixels. So, X and Y offset determine where the shadow will be placed in relation to the image. High values make the imaginary source of light look like it's far away in horizontal or vertical direction, and low values will make it look closer to the image.

The offsets may be negative, leading to a shadow on the left of the selection if offset $X < 0$, or above the selection if offset $Y < 0$.

Out of sheer curiosity, you can see the drop shadow layer clearly by setting blur radius to 0 and moving the drop shadow with X and Y.

Blur radius After creating the shadow, a **Gaussian blur** with the specified radius is applied to the shadow layer, resulting in the realistic appearance of the drop shadow.

Color The shadow may have any color. Just click on the color swatch, and select a color when the color selector pops up or use the eye-dropper.

Opacity Shadow opacity. It defaults to 0.500, but you may select any other value from 0 (full transparency) to 2.00 (full opacity) here.

Clipping The result of this filter can be larger than the original image. With the default Adjust option, the layer will be automatically resized as necessary when the filter is applied. With the Clip option the result will be clipped to the layer boundary.

17.6.7.4 Using Drop Shadow Filter

This GEGL Drop Shadow filter is surprising: if you apply the filter directly to the image as you do with the legacy filter, you get nothing!

To get the same result as the legacy filter:

1. Open your original image.
2. Open a new image, a little bigger than your original image, filled with *transparency*.
3. Copy your original image and paste it into the new image. A floating selection is created in the layer dialog.
4. Anchor the floating selection.
5. Menus/Layer/Crop to content.
6. Menus/Layer/Layer boundary size: set layer size to the same size than your image and filled with transparency; click on the Center button. Then click on the Resize button.
7. Open the Drop Shadow dialog: the drop shadow is displayed in the on-canvas preview. You can change the default options values.
8. Eventually, add a new layer, with the same size as the image and filled with the color you want to give to the background. Move this layer to the bottom of the layer stack.
9. Click on the OK to apply filter.

Applying filter to a selection:

1. Open your original image.
2. Open a new image, the same size as your original image, filled with *transparency*.
3. Create the selection
4. Copy the selection and paste it into the new image. A floating selection is created in the layer dialog.
5. Anchor the floating selection.
6. Menus/Layer/Crop to content.
7. Menus/Layer/Layer to image size (with transparency).
8. Open the Drop Shadow dialog: the drop shadow is displayed in the on-canvas preview. You can change the default options values.
9. Eventually, add a new layer, with the same size as the image and filled with the color you want to give to the background. Move this layer to the bottom of the layer stack.
You can also use your original image as background: undo the selection, copy the image and paste it as new layer in the new image. Move the new layer to the bottom of the layer stack.
10. Click on the OK to apply filter.

Applying filter to a text:

The procedure is more simple to create a drop shadow for a text: create the text and apply the Drop Shadow filter directly.

17.6.8 Long Shadow

17.6.8.1 Overview

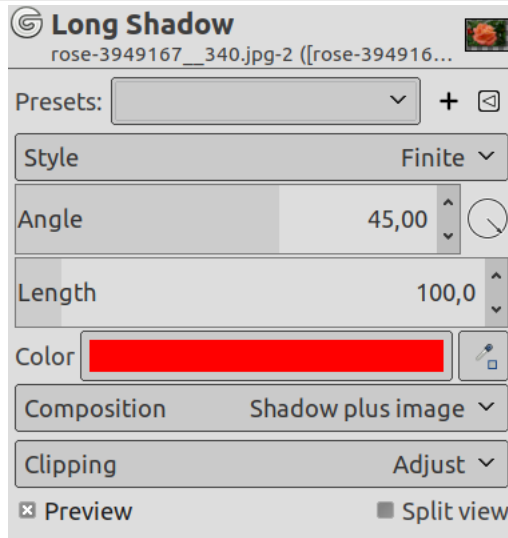
This GEGL-based filter appeared with GIMP-2.10.6. It simplifies creating long shadows in several visual styles.

17.6.8.2 Activate the filter

You can find this filter in the image menu menu through Filters → Light and Shadow → Long Shadow.... This filter is normally disabled. You must add an Alpha channel to your image to use it.


17.6.8.3 Options

Figure 17.124 "Long Shadow" filter options



Presets, Preview, Split view

Note



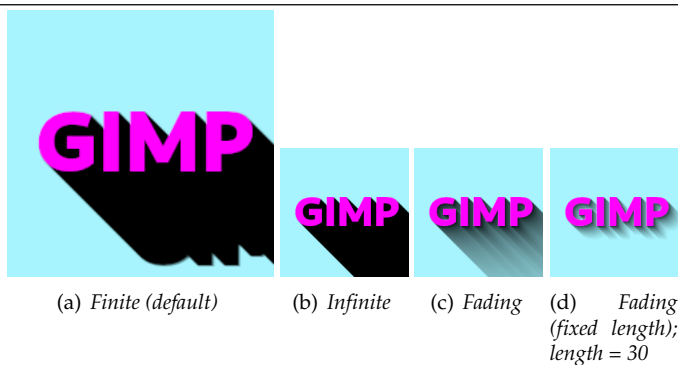
These options are described in Section 17.2.

Style

Original: the text layer is Menu/layer/Layer to Image Size

You can use different styles Finite that is default, Infinite, Fading, and Fading (fixed length).

Figure 17.125 "Style" option examples



Angle Shadow angle, in degrees.



Angle = 110°

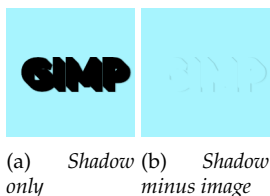
Length Shadow length, in pixels



Length = 30

Composition Shadow plus image is default.

Figure 17.126 “Composition” option examples



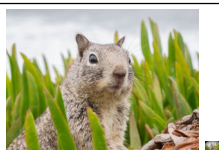
Clipping The result of this filter can be larger than the original image. With the default Adjust option, the layer will be automatically resized as necessary when the filter is applied. With the Clip option the result will be clipped to the layer boundary.

17.6.9 Vignette

17.6.9.1 Overview

In photography, *vignetting* is a reduction of the image brightness toward periphery. It is often an undesired effect due to camera settings or lens limitations. But it is also deliberately used to draw attention to the center of the image. “Vignette” can produce this effect.

Figure 17.127 Original images used for examples



(a) Original (b) Filter applied with default options

GIMP-2.10.20 comes with on-canvas controls (default): two limits with white handles that turn to orange, and become active, when mouse pointer hovers over them. The black (default) area is the *vignette*. The *outer limit* is the limit of the vignette. The *inner limit* is the limit of the *soft area*, the unchanged area. Between the outer and the inner limits is the *fade area*, where the vignette is fading progressively, with a dotted line that is the *midpoint line*.



Vignette with default options and on-canvas controls

Click-and-drag action is different on lines and on handles:

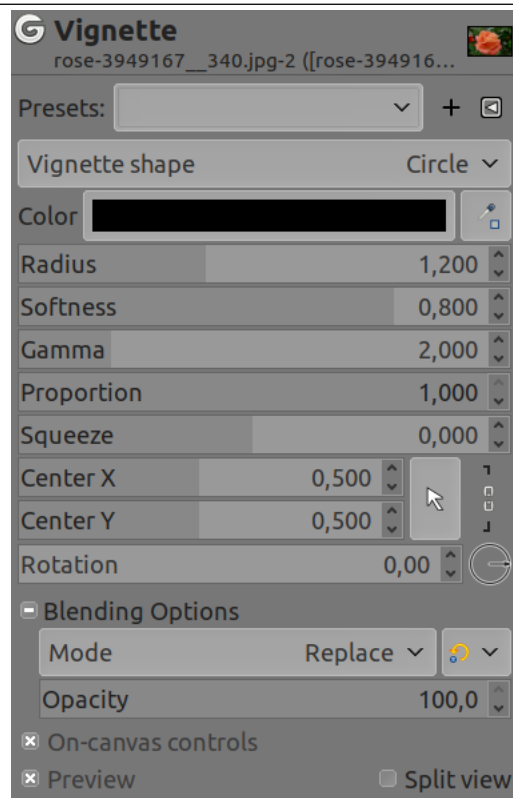
- Click-and-drag a limit line to move the limit and the midpoint (Radius and Softness).
- Click-and-drag a handle to move both limits (Radius and Squeeze).
- Click-and-drag the midpoint line to move it.
- In the three cases, pressing **Shift** only changes Radius.

17.6.9.2 Activate the filter

You can find this filter in the image menu menu through Filters → Light and Shadow → Vignette....

17.6.9.3 Options

Figure 17.128 “Vignette” filter options



Presets, Preview, Split view, Blending options**Note**

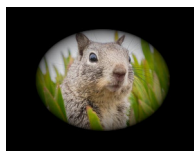
These options are described in Section 17.2.

Vignette shape

- Circle
- Square
- Diamond
- Horizontal, Vertical: limits and line are horizontal or vertical.

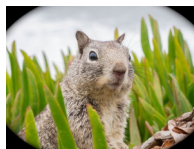
The shape of the vignette (ellipse or circle for example) depends on Proportion setting.

Radius Vignette size: how far out vignetting goes as part of half image diagonal.



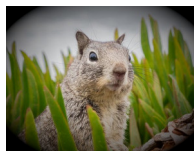
Radius = 0.700

Softness Soft (unchanged) area size.



Softness = 0.100

Gamma Falloff linearity controls the curve of the falloff from the center to periphery: set how fast is brightness reduced towards edges of the vignette(fading area size).

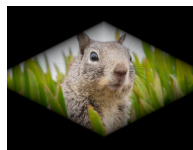


Gamma = 1.00

Proportion Proportion is particular: with the default value (maxi) 1.00, the vignette is a circle in a square image and an ellipse in a rectangular image. Reducing Proportion, this ellipse tends to a circle.

Squeeze Aspect ratio to use:

- 0.0 = 1:1
- 0.5 = 2:1



Diamond shape, proportion = 0.0 and squeeze = 0.5

- 1.0 = completely squeezed vertically
- -0.5 = 1:2
- -1.0 = completely squeezed horizontally

Note

To directly use squeeze factor as proportion, set Proportion to 0.0.

Center X, Center Y Coordinates of vignette center. Origin is the upper left corner of the image. 1.00 is the right border of the image. The center can be placed outside of the image.

Rotation Rotation of the vignette. The vignette keeps its shape.

You can also click-and-drag outside the outer limit to rotate the vignette.

On-canvas controls Uncheck this option to remove on-canvas controls.

17.6.10 Drop Shadow (legacy)

17.6.10.1 Overview

Figure 17.129 Example for the “Drop Shadow (legacy)” filter



(a) Original image

(b) “Drop Shadow (legacy)” applied (white background layer added manually)

This filter adds a drop-shadow to the current selection or to the image if there’s no active selection. Optional the filter resizes the image if that’s necessary for displaying the shadow.

You may choose the color, position, and size of the shadow.

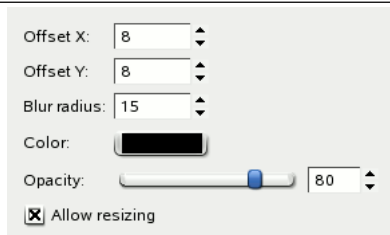
Please note that the filter does not add a background layer to make the shadow visible. The shadow’s background is transparent. The white background in the above example has not been created by the filter, instead it has been added later to let you see the shadow.

17.6.10.2 Activate the filter

You can find this filter in the image menu menu through Filters → Light and Shadow → Drop Shadow (legacy)....

17.6.10.3 Options

Figure 17.130 “Drop Shadow (legacy)” filter options



Offset X, Offset Y The layer containing the drop shadow will be moved horizontally by X pixels, vertically by Y pixels. So, X and Y offset determine where the shadow will be placed in relation to the image. High values make the imaginary source of light look like it’s far away in horizontal or vertical direction, and low values will make it look closer to the image.

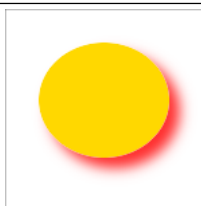
The offsets may be negative, leading to a shadow on the left of the selection if offset $X < 0$, or above the selection if offset $Y < 0$.

If there’s no active selection, you must have Allow resizing enabled to see any effect.

Blur radius After creating the shadow, a **Gaussian blur** with the specified radius is applied to the shadow layer, resulting in the realistic appearance of the drop shadow. It may be necessary to enable Allow resizing, since blurring extends the shadow.

Color The shadow may have any color. Just click on the button, and select a color when the color selector pops up.

Figure 17.131 “Drop Shadow” color example



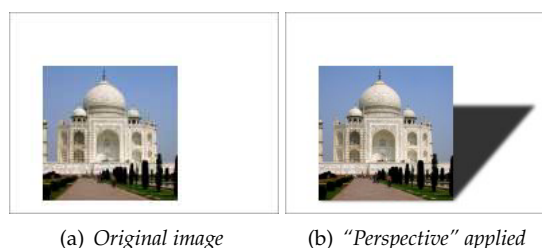
Opacity The shadow’s opacity is just the opacity of the new layer containing the shadow (see Section 8.1.1). It defaults to 80%, but you may select any other value from 0 (full transparency) to 100 (full opacity) here. After applying the filter to an image you can change the opacity in the **layers dialog**.

Allow resizing If enabled, the filter will resize the image if that is needed to make place for the shadow. The new size depends on the size of the selection, the blur radius, and the shadow offsets.

17.6.11 Perspective

17.6.11.1 Overview

Figure 17.132 Example for the “Perspective” filter



This filter adds a perspective shadow to the selected region or alpha-channel as a layer below the active layer. You may select color, length and direction of the shadow as well as the distance of the horizon.

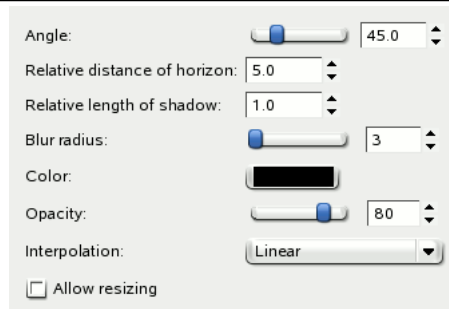
If necessary, the filter may resize the image. But it will not add a background to make the shadow visible.

17.6.11.2 Activate the filter

You can access this filter in the image window menu through Filters → Light and Shadow → Perspective...

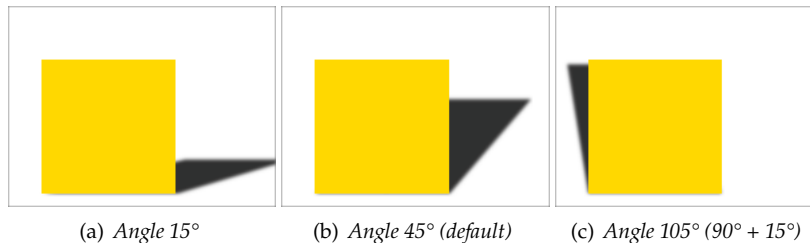
17.6.11.3 Options

Figure 17.133 “Perspective” options



Angle The angle determines the direction of the shadow or the imaginary source of light, respectively. Values range from 0° to 180° , where 90° represents a light source just in front of the selection or layer. For angles less than 90° , the shadow is at the right side, so the light source is on the left. For angles greater than 90° , it's the other way round. Tip: think of the slider's handle as source of light.

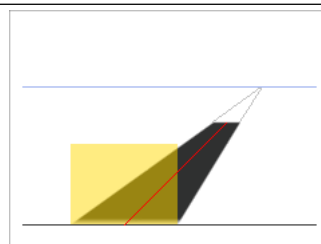
Figure 17.134 “Angle” example



Relative distance of horizon This option determines how far away the imaginary horizon is. The relative distance is the distance from the ground-line of the selection or layer, the “unit” of measurement is the height of the selection or layer.

Value range is from 0.1 to 24.1, where 24.1 means (nearly) “infinite”. Note that the relative length of shadow must not exceed the distance of horizon.

Figure 17.135 “Distance of horizon” example



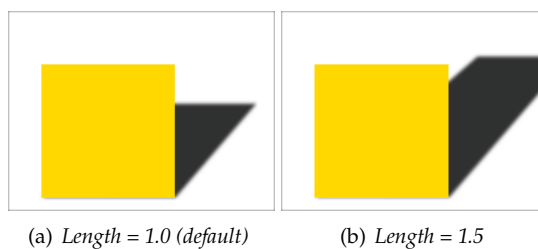
Angle = 45° . Distance = 2.4. Length = 1.8.

In the example above, the yellow area is the selection the filter is applied to. The blue line at the top represents the imaginary horizon. The angle between the selection's ground-line and the red line is 45° . The length of the red line is 1.8 times the height of the yellow selection. Extended to the horizon, the length is 2.4 times the selection's height.

Relative length of shadow With this option you can set the length of shadow with respect to the height of the selection or layer. In the above example, the red line represents the length of shadow, its length is 1.8 relative to the height of the yellow selection.

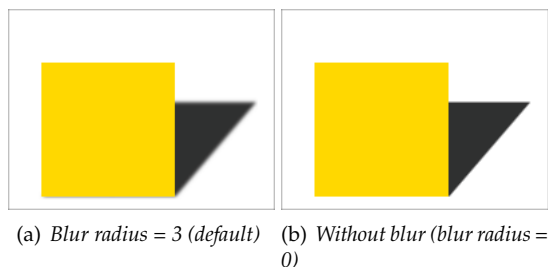
Value range is from 0.1 to 24.1, although the length of shadow must not exceed the relative distance of horizon - you can't go beyond the horizon.

Figure 17.136 "Length of Shadow" example



Blur radius After creating the shadow, a **Gaussian blur** with the specified radius is applied to the shadow layer, resulting in the realistic appearance of the shadow.

Figure 17.137 Blur example



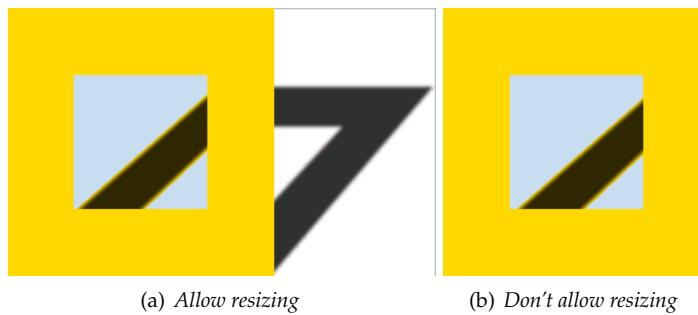
Color Of course, the default color of the shadow is black. But a click on the button opens the color selector, where you may select any other color.

Opacity The shadow's opacity is the opacity of the new layer containing the shadow (see Section 8.1.1). It defaults to 80%, but you may select any other value from 0 (full transparency) to 100 (full opacity) here. After applying the filter to an image you can change the opacity in the **layers dialog**.

Interpolation This drop-down list lets you choose the method of **interpolation** used when the shadow layer is transformed, for example rotated by the specified angle. Using None will usually result in aliasing, using any interpolation method may change the color of the shadow in some areas. Linear is a good choice.

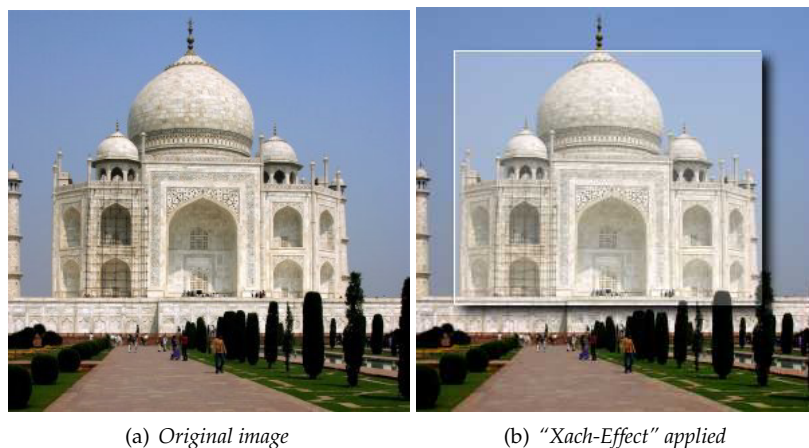
Allow resizing If enabled, the filter will resize the image if that is needed to make place for the shadow.

In the example below, the yellow area is the active selection, background is light blue. The white area has been added after resizing to make the shadow visible.

Figure 17.138 “Allow resizing” example

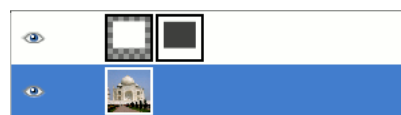
17.6.12 Xach-Effect

17.6.12.1 Overview

Figure 17.139 Example for the “Xach-Effect” filter

This filter adds a subtle translucent 3D effect to the selected region or alpha channel. This 3D effect is achieved by

1. Highlighting the selection: a new layer (“Highlight”) will be created above the active layer, filled with the highlight color. Then a **layer mask** will be added to that layer making the unmasked pixel partially transparent.



Highlight layer with layer mask

2. Painting the selection’s left and top edges with the highlight color: for that the “Highlight” layer will be extended by one pixel left and up. These small areas will be opaque.
3. Creating a **drop shadow** at the bottom right side of the selection.

You may vary these default settings, for example select different colors for highlight or shadow and change amount and directions of offsets.

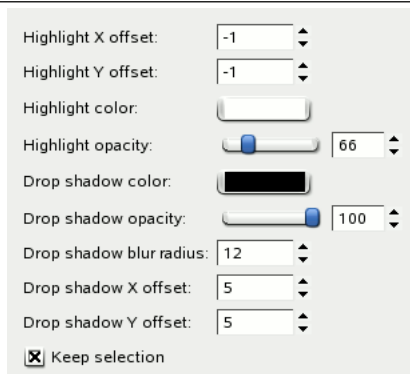
17.6.12.2 Activate the filter

The filter is found in the image window menu under Filters → Light and Shadow → Xach-Effect....

17.6.12.3 Options

There are two groups of options, each controlling the highlight or the shadow, and a checkbox for the selection behaviour.

Figure 17.140 “Xach-Effect” options



Highlight X offset, Highlight Y offset The selection’s left and top edge are painted with the highlight color. The highlight offset is the size (width or height) of the respective area. If offset is less than 0 (this is the default), the left (X offset < 0) or top (Y offset < 0) area will be colored. If offset is greater than 0, the right (X offset > 0) or bottom (Y offset > 0) area will be painted.

Highlight color This is the color used to highlight the selected area. It defaults to white, but clicking on the swatch button brings up a color selector and you may select any other color.

Highlight opacity The selection will be covered by a partially transparent area filled with the highlight color. This option lets you set the level of transparency. Since a **layer mask** will be used, the value ranges from 0 (full transparency) to 255 (full opacity).

The highlight opacity defaults to 66, which is equivalent to 26%.

Drop shadow options These options work like the respective **Drop Shadow** options (without resizing). Briefly:

Drop shadow color Click on the button to open a color selector.

Drop shadow opacity The opacity (0% - 100%) of the layer containing the shadow.

Drop shadow blur radius The radius used by the **Gaussian blur** filter, which will be applied to the shadow.

Drop shadow X offset, Drop shadow Y offset Direction and amount, by which the shadow will be moved from the selection.

Keep selection If checked, the active selection will remain active when the filter has been applied.

17.7 Noise Filters

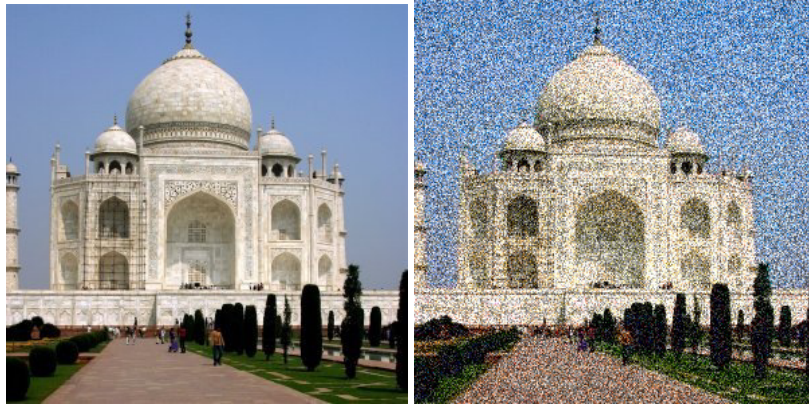
17.7.1 Introduction

Noise filters *add* noise to the active layer or to the selection. To *remove* small defects from an image, see the **Despeckle** and **Selective Gaussian Blur** filters.

17.7.2 CIE lch Noise

17.7.2.1 Overview

Figure 17.141 Example of applying the “CIE lch Noise” filter



(a) Original image

(b) Filter “CIE lch Noise” applied

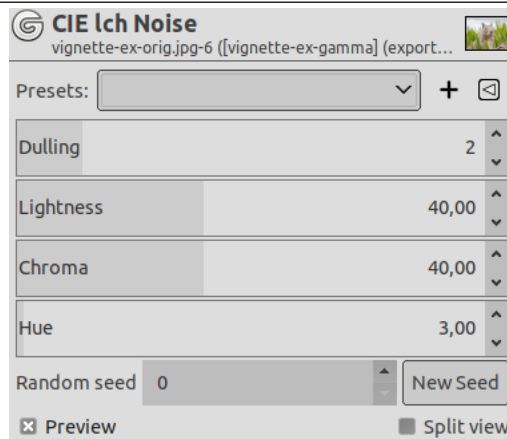
The CIE lch Noise filter creates noise in the active layer or selection by using the Lightness, Chroma, Hue color model, according to the CIE (“Compagnie Internationale de l’Éclairage”) specifications.

17.7.2.2 Activate the filter

You can find this filter through Filters → Noise → CIE lch Noise....

17.7.2.3 Options

Figure 17.142 “CIE lch Noise” filter options



Presets, Preview, Split view

Note



These options are described in Section 17.2.

Dulling This slider (1 -8) controls the randomness of the noise: a high value lowers the randomness.

Chroma This slider changes the chroma of the pixels in a random pattern (percentage of a white of the same lightness).

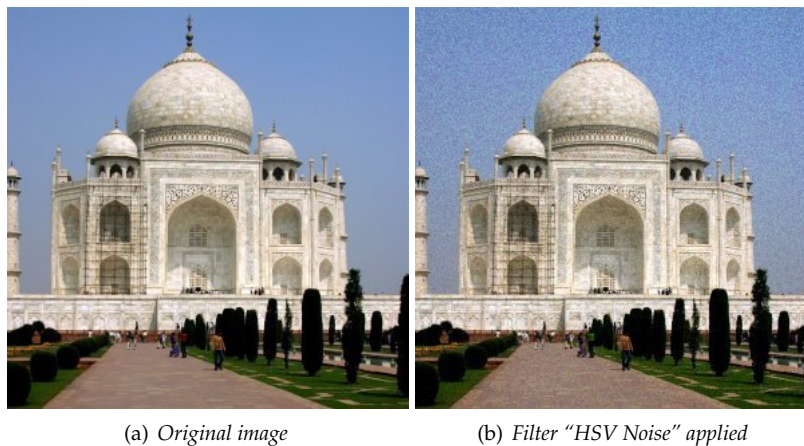
Hue This slider changes hue of the pixels in a random pattern. It selects an increasing available color range in the HSV color circle starting from the original pixel color.

Random seed You can change the seed for randomness.

17.7.3 HSV Noise

17.7.3.1 Overview

Figure 17.143 Example of applying the “HSV Noise” filter



(a) Original image

(b) Filter “HSV Noise” applied

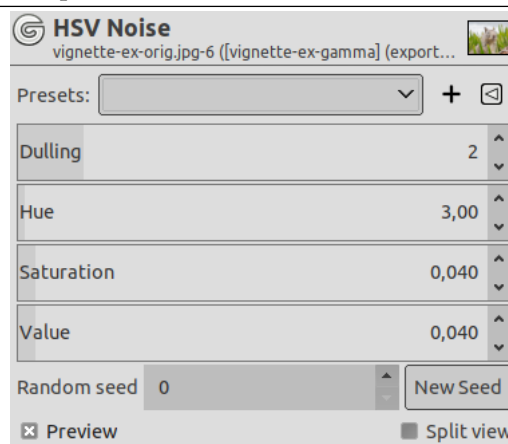
The HSV Noise filter creates noise in the active layer or selection by using the Hue, Saturation, Value (luminosity) color model.

17.7.3.2 Activate the filter

You can find this filter through Filters → Noise → HSV Noise....

17.7.3.3 Options

Figure 17.144 “HSV Noise” filter options



Presets, Preview, Split view**Note**

These options are described in Section 17.2.

Dulling This slider (1 -8) controls how much the new pixel color value is allowed to be applied compared to the existing color. A low dulling will give an important hue variation. A high dulling will give a weak variation.

Hue This slider changes the color of the pixels in a random pattern. It selects an increasing available color range in the HSV color circle starting from the original pixel color.

Saturation This slider increases saturation of scattered pixels.

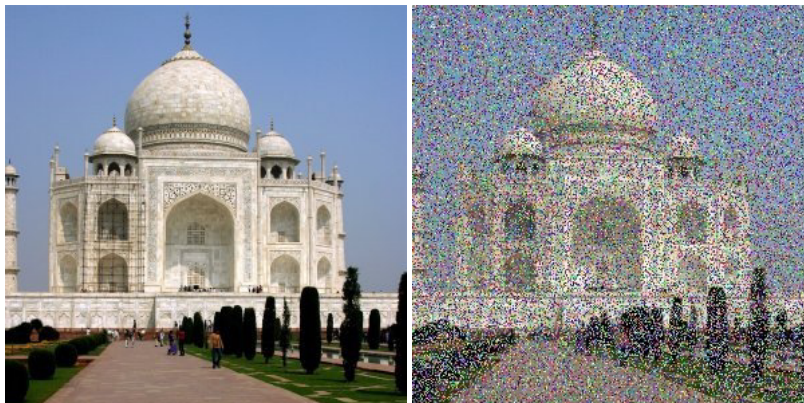
Value This slider increases brightness of scattered pixels.

Random seed You can change the seed for randomness.

17.7.4 Hurl

17.7.4.1 Overview

Figure 17.145 Example for the “Hurl” filter



(a) Original image

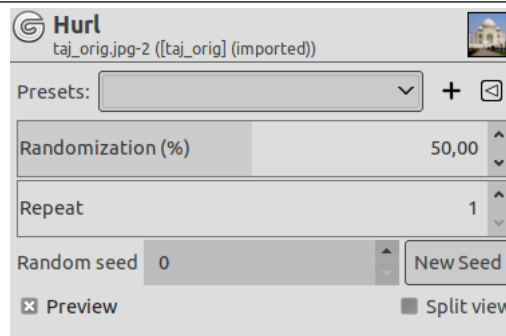
(b) Filter “Hurl” applied

You can find this filter through Filters → Noise → Hurl....

The Hurl filter changes each affected pixel to a random color, so it produces real *random noise*. All color channels, including an alpha channel (if it is present) are randomized. All possible values are assigned with the same probability. The original values are not taken into account. All or only some pixels in an active layer or selection are affected, the percentage of affected pixels is determined by the Randomization (%) option.

17.7.4.2 Options

Figure 17.146 “Hurl” options



Presets, Preview, Split view

Note



These options are described in Section 17.2.

Randomization (%) This slider represents the percentage of pixels of the active layer or selection which will be hurled. The higher value, the more pixels are hurled.

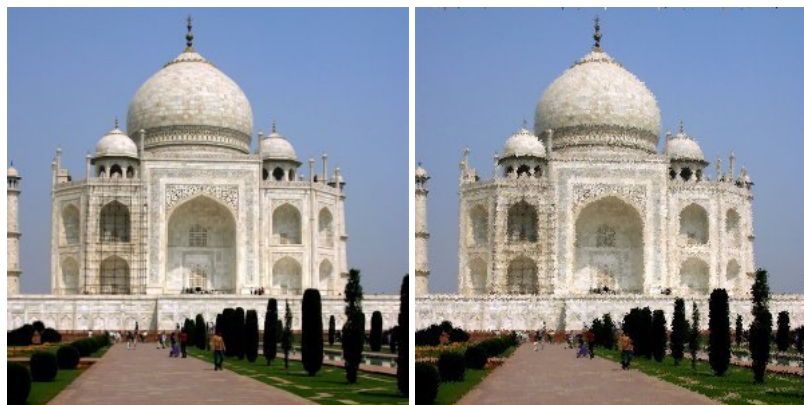
Repeat It represents the number of times the filter will be applied. In the case of the Hurl filter it is not very useful, because the same results can be obtained faster just by using a higher Randomization (%) value.

Random seed Controls randomness of hurl. If the same random seed in the same situation is used, the filter produces exactly the same results. A different random seed produces different results. Random seed can be entered manually or generated randomly by pressing New Seed button.

17.7.5 Pick

17.7.5.1 Overview

Figure 17.147 Example of applying the “Pick” filter



(a) Original image

(b) Filter “Pick” applied

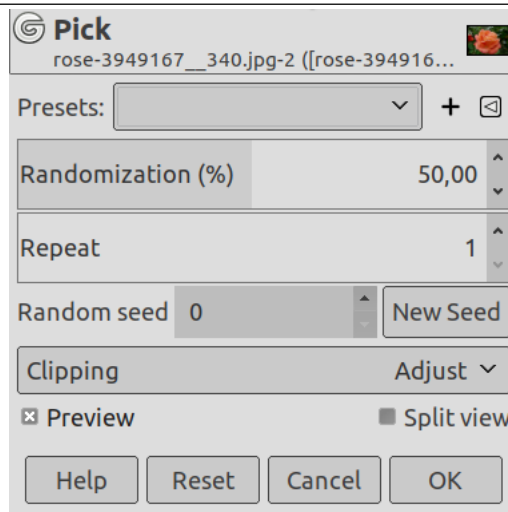
The Pick filter replaces each affected pixel by a pixel value randomly chosen from its eight neighbours and itself (from a 3×3 square the pixel is center of). All or only some pixels in an active layer or selection are affected, the percentage of affected pixels is determined by the Randomization (%) option.

17.7.5.2 Activate the filter

You can find this filter through Filters → Noise → Pick....

17.7.5.3 Options

Figure 17.148 “Pick” filter options



Presets, Preview, Split view

Note



These options are described in Section [17.2](#).

Randomization (%) This slider represents the percentage of pixels of the active layer or selection which will be picked. The higher value, the more pixels are picked.

Repeat This slider represents the number of times the filter will be applied. Higher values result in more picking, pixel values being transferred farther away.

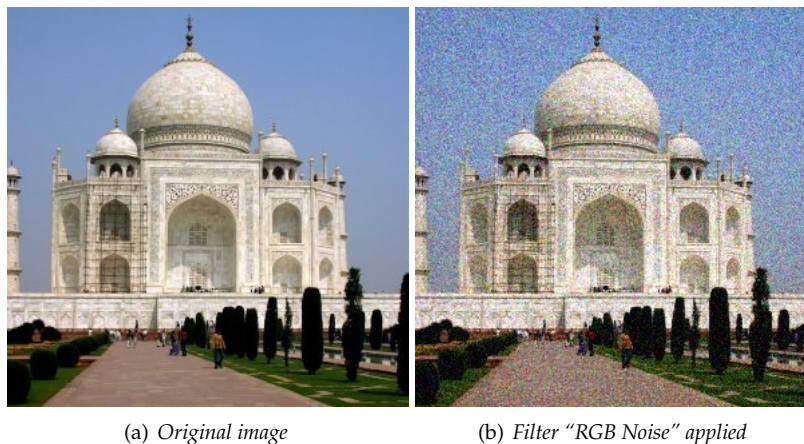
Random seed Controls randomness of picking. If the same random seed in the same situation is used, the filter produces exactly the same results. A different random seed produces different results. Random seed can be entered manually or generated randomly by pressing New Seed button.

Clipping The result of this filter can be larger than the original image. With the default Adjust option, the layer will be automatically resized as necessary when the filter is applied. With the Clip option the result will be clipped to the layer boundary.

17.7.6 RGB Noise

17.7.6.1 Overview

Figure 17.149 Example of applying the “RGB Noise” filter



The RGB Noise filter adds a normally distributed noise to a layer or a selection. It uses the RGB color model to produce the noise (noise is added to red, green and blue values of each pixel). A normal distribution means, that only slight noise is added to the most pixels in the affected area, while less pixels are affected by more extreme values. (If you apply this filter to an image filled with a solid grey color and then look at its histogram, you will see a classic bell-shaped Gaussian curve.)

The result is very naturally looking noise.

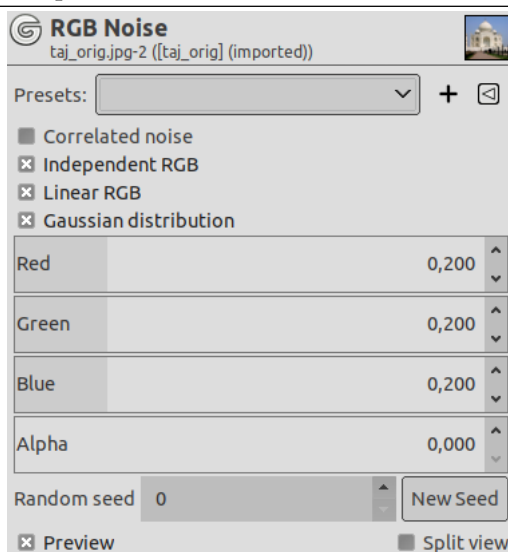
This filter does not work with indexed images.

17.7.6.2 Activate the filter

You can find this filter through Filters → Noise → RGB Noise....

17.7.6.3 Options

Figure 17.150 “RGB Noise” filter options



Presets, Preview, Split view**Note**

These options are described in Section 17.2.

Correlated noise Noise may be additive (uncorrelated) or multiplicative (correlated - also known as speckle noise). When checked, every channel value is multiplied by a normally distributed value. So the noise depends on the channel values: a greater channel value leads to more noise, while dark colors (small values) tend to remain dark.

Independent RGB When this radio button is checked, you can move each RGB slider separately. Otherwise, sliders R, G and B will be moved all together. The same relative noise will then be added to all channels in each pixel, so the hue of pixels does not change much.

Linear RGB Operate on linearized RGB color data.

Gaussian distribution Use a gaussian noise distribution. When unchecked, a linear noise distribution is used instead.

Red, Green, Blue, Alpha These slidebars and adjacent input boxes allow to set noise level (0.00 - 1.00) in each channel. Alpha channel is only present if your layer holds such a channel. In case of a grayscale image, a Grey is shown instead of color sliders.

The value set by these sliders actually determine the standard deviation of the normal distribution of applied noise. The used standard deviation is a half of the set value (where 1 is the distance between the lowest and highest possible value in a channel).

17.7.7 Slur**17.7.7.1 Overview**

Figure 17.151 Example of applying the Slur filter



(a) Original image

(b) Filter "Slur" applied

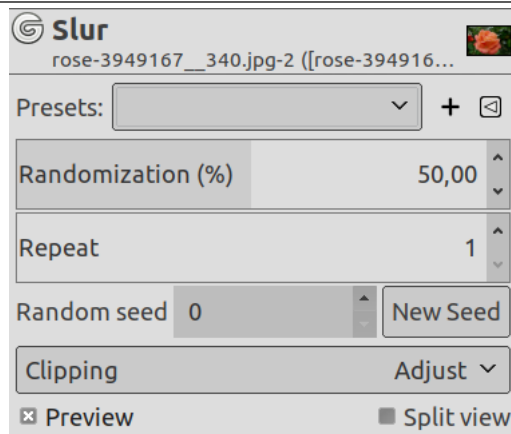
Slurring produces an effect resembling melting the image downwards; if a pixel is to be slurred, there is an 80% chance that it is replaced by the value of a pixel directly above it; otherwise, one of the two pixels to the left or right of the one above is used. All or only some pixels in an active layer or selection are affected, the percentage of affected pixels is determined by the Randomization (%) option.

17.7.7.2 Activate the filter

You can find this filter through Filters → Noise → Slur....

17.7.7.3 Options

Figure 17.152 Slur filter options



Presets, Preview, Split view

Note



These options are described in Section [17.2](#).

Randomization (%) This slider represents the percentage of pixels of the active layer or selection which will be slurred. The higher value, the more pixels are slurred, but because of the way the filter works, its effect is most noticeable if this slider is set to a medium value, somewhere around 50. Experiment with it and try for yourself!

Repeat This slider represents the number of times the filter will be applied. Higher values result in more slurring, moving the color over a longer distance.

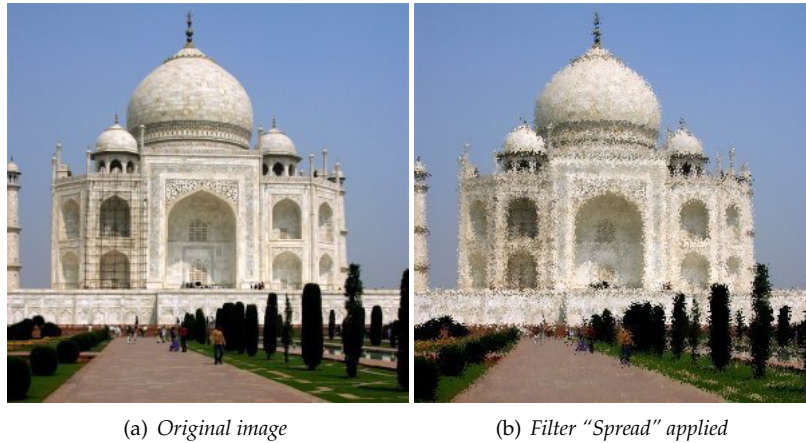
Random seed Controls randomness of slurring. If the same random seed in the same situation is used, the filter produces exactly the same results. A different random seed produces different results. Random seed can be entered manually or generated randomly by pressing New Seed button.

Clipping The result of this filter can be larger than the original image. With the default Adjust option, the layer will be automatically resized as necessary when the filter is applied. With the Clip option the result will be clipped to the layer boundary.

17.7.8 Spread

17.7.8.1 Overview

Figure 17.153 Example of applying the Spread filter



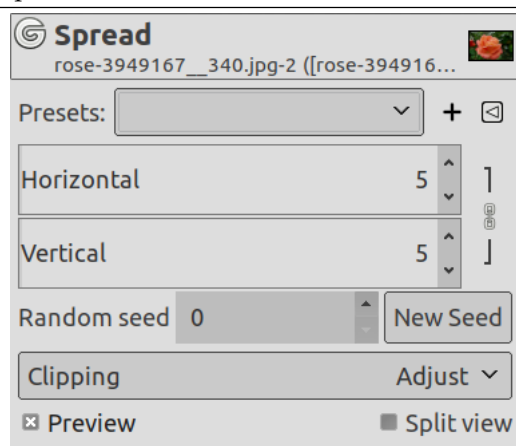
The Spread filter swaps each pixel in the active layer or selection with another randomly chosen pixel by a user specified amount. It works on color transitions, not on plain color areas. No new color is introduced.

17.7.8.2 Activate the filter

You can find this filter through Filters → Noise → Spread....

17.7.8.3 Options

Figure 17.154 "Spread" filter options



Presets, Preview, Split view

Note



These options are described in Section [17.2](#).

Horizontal, Vertical You can set the distance that pixels will be moved along Horizontal and Vertical axis. The axis can be locked by clicking the Chain icon.

Random seed Controls randomness of spreading. If the same random seed in the same situation is used, the filter produces exactly the same results. A different random seed produces different results. Random seed can be entered manually or generated randomly by pressing New Seed button.

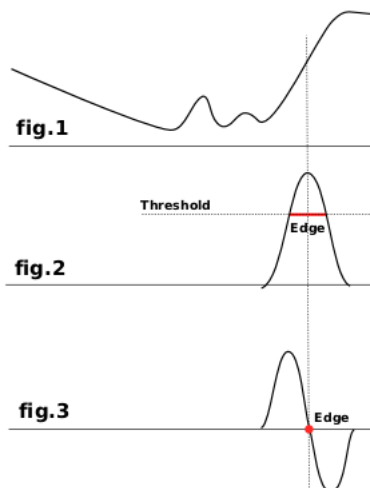
Clipping The result of this filter can be larger than the original image. With the default Adjust option, the layer will be automatically resized as necessary when the filter is applied. With the Clip option the result will be clipped to the layer boundary.

17.8 Edge-Detect Filters

17.8.1 Introduction

Edge detect filters search for borders between different colors and so can detect contours of objects.

They are used to make selections and for many artistic purposes.



Most of them are based on gradient calculation methods and give thick border lines. Look at fig.1 which represents color intensity variations. On the left is a slow color gradient which is not a border. On the right is a quick variation which is an edge. Now, let us calculate the gradient, the variation speed, of this edge, i.e. the first derivative (fig.2). We have to decide that a border is detected when gradient is more than a threshold value (the exact border is at top of the curve, but this top varies according to borders). In most cases, threshold is under top and border is thick.

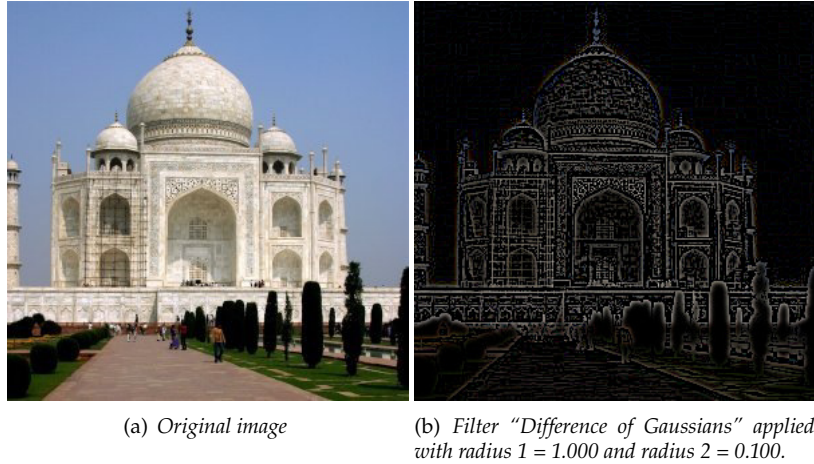
The Laplacian edge detection uses the second derivative (fig.3). The top of the curve is now at zero and clearly identified. That's why Laplace filter renders a thin border, only a pixel wide. But this derivative gives several zeros corresponding to small ripples, resulting in false edges.

Some blurring before applying edge filters is often necessary: it flattens small ripples in signal and so prevents false edges.

17.8.2 Difference of Gaussians

17.8.2.1 Overview

Figure 17.155 Applying example for the “Difference of Gaussians” filter



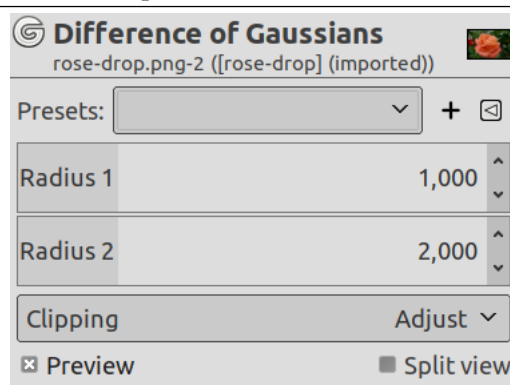
This filter does edge detection using the so-called “Difference of Gaussians” algorithm, which works by performing two different Gaussian blurs on the image, with a different blurring radius for each, and subtracting them to yield the result. This algorithm is very widely used in artificial vision (maybe in biological vision as well!), and is pretty fast because there are very efficient methods for doing Gaussian blurs. The most important parameters are the blurring radii for the two Gaussian blurs. It is probably easiest to set them using the preview, but it may help to know that increasing the smaller radius tends to give thicker-appearing edges, and decreasing the larger radius tends to increase the “threshold” for recognizing something as an edge. In most cases you will get nicer results if Radius 2 is smaller than Radius 1, but nothing prevents you from reversing them, and in situations where you have a light figure on the dark background, reversing them may actually improve the result.

17.8.2.2 Activating the filter

You can find this filter through Filters → Edge-Detect → Difference of Gaussians....

17.8.2.3 Options

Figure 17.156 Gaussian Difference filter options



Presets, Preview, Split view

Note



These options are described in Section 17.2.

Radius 1, Radius 2 Radius 1 and Radius 2 are the blurring radii for the two Gaussian blurs. If you want to produce something that looks like a sketch, in most cases setting “Radius 2” smaller than “Radius 1” will give better results.

Clipping The result of this filter can be larger than the original image. With the default Adjust option, the layer will be automatically resized as necessary when the filter is applied. With the Clip option the result will be clipped to the layer boundary.

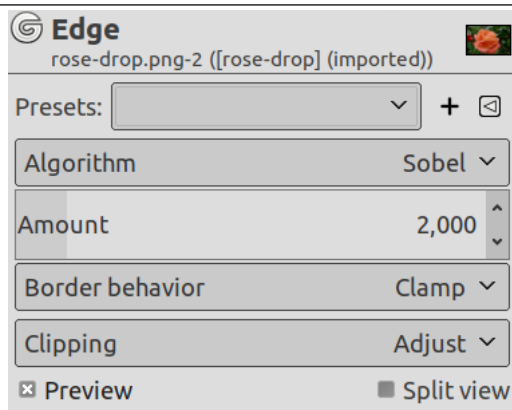
17.8.3 Edge

17.8.3.1 Activating the filter

You can find this filter through Filters → Edge-Detect → Edge....

17.8.3.2 Options

Figure 17.157 Edge filter options



Presets, Preview, Split view

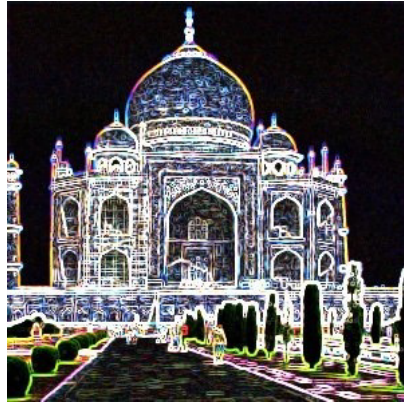
Note



These options are described in Section 17.2.

Algorithm Edge detector offers several detection methods:

Sobel Here, this method has no options and so is less interesting than the specific Sobel.



After applying the filter (Sobel option)

Prewitt compass Result doesn't look different from Sobel.



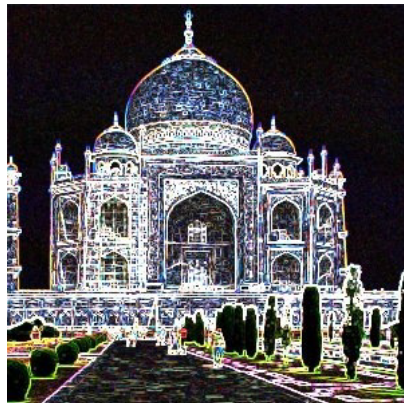
After applying the filter (Prewitt compass option)

Gradient Edges are thinner, less contrasted and more blurred than Sobel.



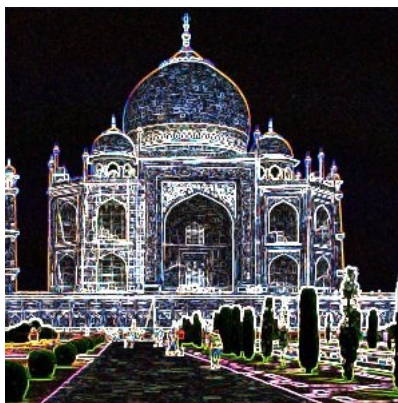
After applying the filter (Gradient option)

Roberts No evident difference from Sobel.



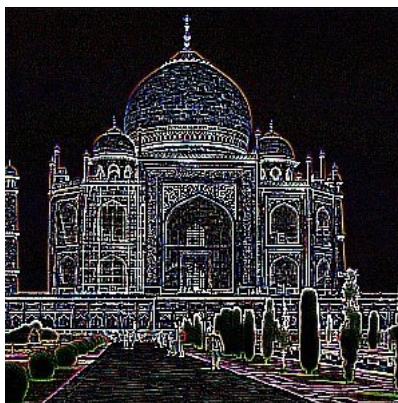
After applying the filter (Roberts option)

Differential Edges less bright.



After applying the filter (Differential option)

Laplace Less interesting than the specific one.



After applying the filter (Laplace option)

Amount A low value results in black, high-contrasted image with thin edges. A high value results in thick edges with low contrast and many colors in dark areas.

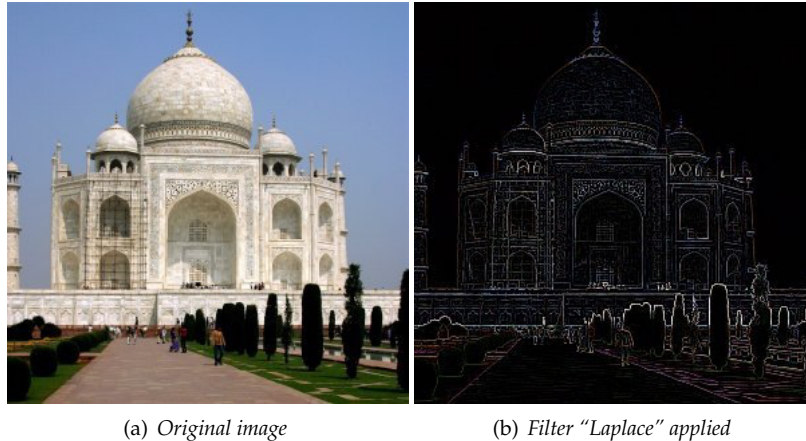
Border behavior Where the edge detector will get adjoining pixels for its calculations when it is working on the image boundaries. This option will only have an effect on the boundaries of the result (if any). Clamp is the default and the best choice.

Clipping The result of this filter can be larger than the original image. With the default Adjust option, the layer will be automatically resized as necessary when the filter is applied. With the Clip option the result will be clipped to the layer boundary.

17.8.4 Laplace

17.8.4.1 Overview

Figure 17.158 Applying example for the Laplace filter



This filter detects edges in the image using Laplacian method, which produces thin, pixel wide borders.

17.8.4.2 Activating the filter

You can find this filter through **Filtres** → **Edge-Detect** → **Laplace**.

17.8.4.3 Options

Presets, Preview, Split view

Note



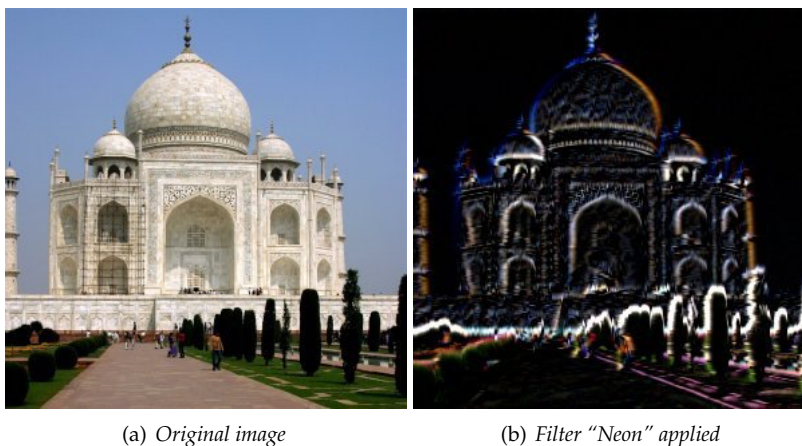
These options are described in Section [17.2](#).

Clipping The result of this filter can be larger than the original image. With the default **Adjust** option, the layer will be automatically resized as necessary when the filter is applied. With the **Clip** option the result will be clipped to the layer boundary.

17.8.5 Neon

17.8.5.1 Overview

Figure 17.159 Applying example for the Neon filter



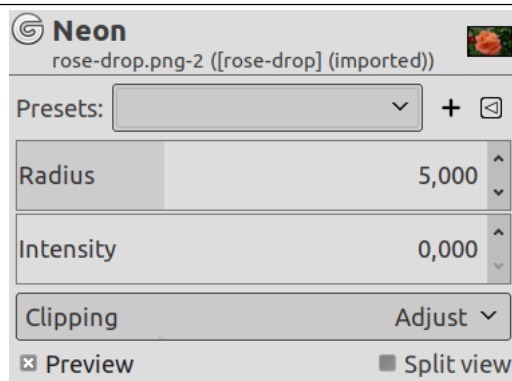
This filter detects edges in the active layer or selection and gives them a bright neon effect.

17.8.5.2 Activating the filter

You can find this filter through Filters → Edge-Detect → Neon....

17.8.5.3 Options

Figure 17.160 Neon filter options



Presets, Preview, Split view

Note



These options are described in Section 17.2.

Radius This option lets you determine how wide the detected edge will be.

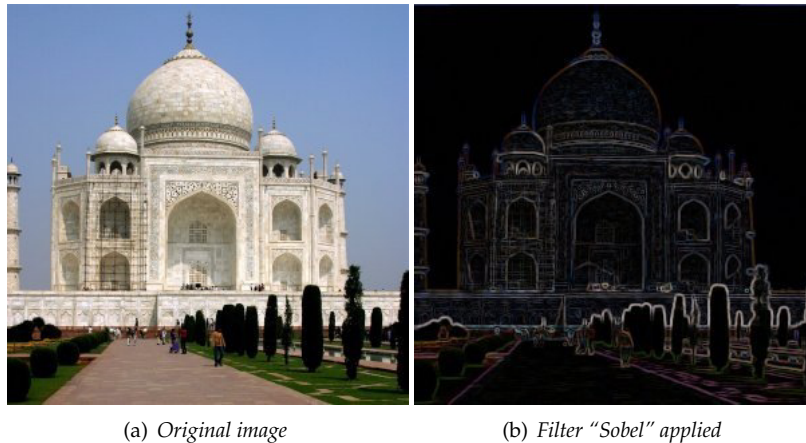
Intensity This option lets you determine how strong the filter effect will be.

Clipping The result of this filter can be larger than the original image. With the default Adjust option, the layer will be automatically resized as necessary when the filter is applied. With the Clip option the result will be clipped to the layer boundary.

17.8.6 Sobel

17.8.6.1 Overview

Figure 17.161 Applying example of the Sobel filter



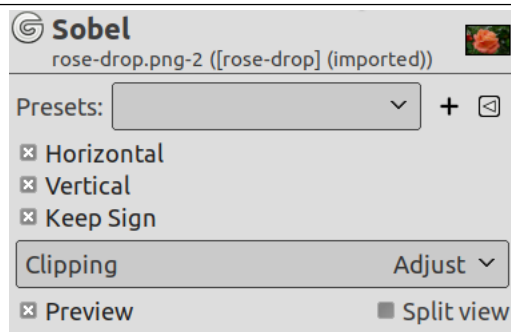
Sobel's filter detects horizontal and vertical edges separately on a scaled image. Color images are turned into RGB scaled images. As with the Laplace filter, the result is a transparent image with black lines and some rest of colors.

17.8.6.2 Activating the filter

You can find this filter through Filters → Edge-Detect → Sobel...

17.8.6.3 Options

Figure 17.162 Sobel filter options



Presets, Preview, Split view

Note



These options are described in Section [17.2](#).

Horizontal Renders near horizontal edges.

Vertical Renders near vertical edges.

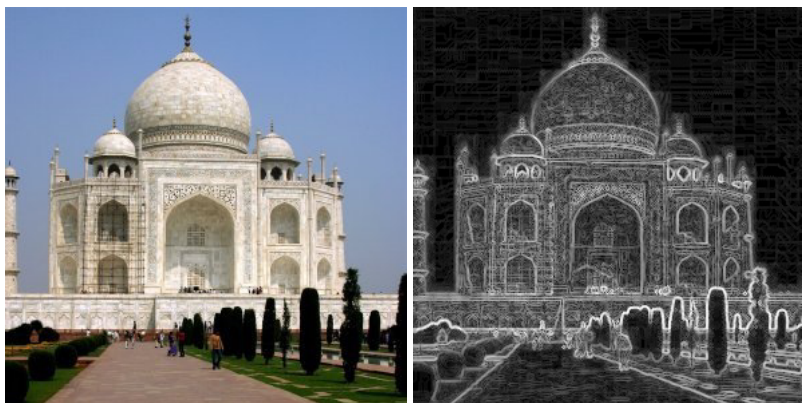
Keep sign This option allows you to set how the filter will work if you have selected one direction for use only: a flat relief with bumps and hollows will be created.

Clipping The result of this filter can be larger than the original image. With the default Adjust option, the layer will be automatically resized as necessary when the filter is applied. With the Clip option the result will be clipped to the layer boundary.

17.8.7 Image Gradient

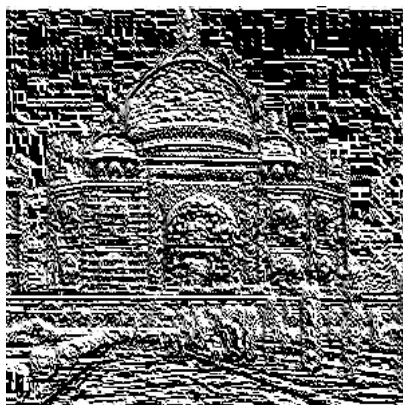
17.8.7.1 Overview

Figure 17.163 Applying example for the Image Gradient filter



(a) Original image

(b) Filter "Image Gradient" applied with default options.



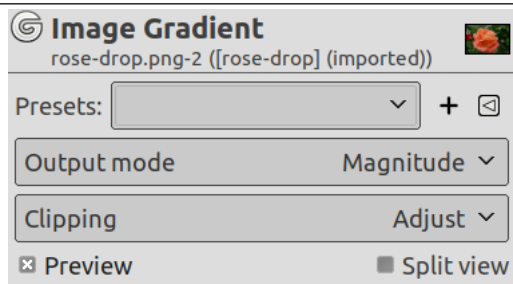
Filter "Image Gradient" applied with Direction option.

This filter detects edges in one or two gradient directions.

17.8.7.2 Activating the filter

You can find this filter through Filters → Edge-Detect → Image Gradient...

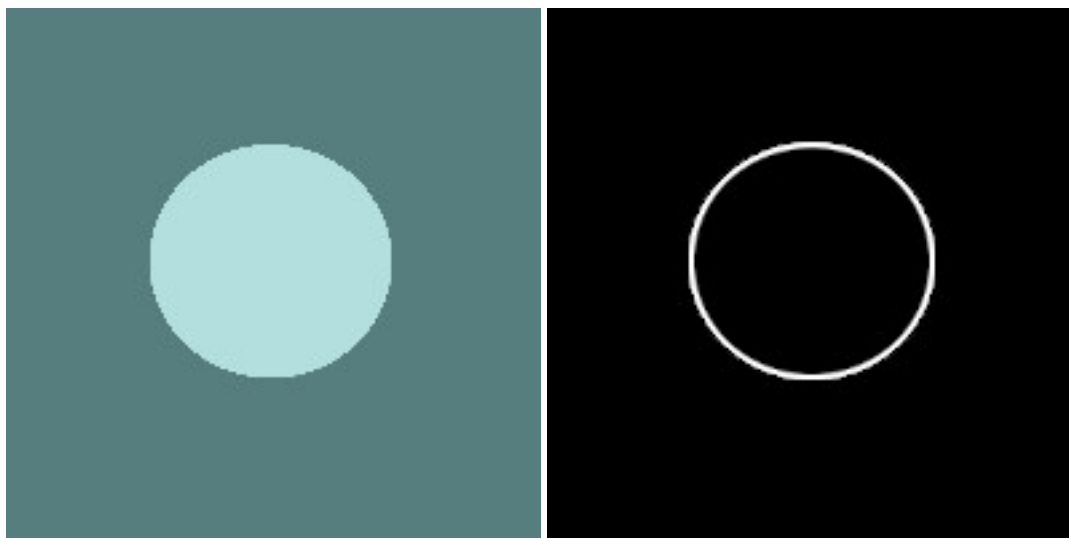
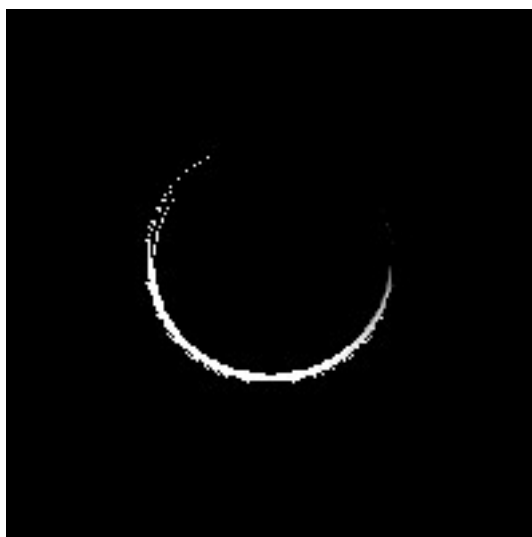
17.8.7.3 Options

Figure 17.164 Image Gradient filter options**Presets, Preview, Split view****Note**

These options are described in Section [17.2](#).

Output mode Magnitude is default: it combines both directions. Direction: only one direction is used. Both is like Magnitude.

Figure 17.165 Output mode examples

(a) *Original image, with abrupt luminosity change*(b) *Option Magnitude is selected*(c) *Option Direction is selected. In result, black is no edge detected, white is edge detected.*

Clipping The result of this filter can be larger than the original image. With the default Adjust option, the layer will be automatically resized as necessary when the filter is applied. With the Clip option the result will be clipped to the layer boundary.

17.9 Generic Filters

17.9.1 Introduction

Generic filters are a catch-all for filters which can't be placed elsewhere. You can find:

- The **Convolution Matrix** filter which lets you build custom filters.
- The **Distance Map** filter.
- The **GEGl graph** filter.
- The **Dilate** filter.
- The **Erode** filter.

17.9.2 Convolution Matrix

17.9.2.1 Overview

Here is a mathematician's domain. Most of filters are using convolution matrix. With the Convolution Matrix filter, if the fancy takes you, you can build a custom filter.

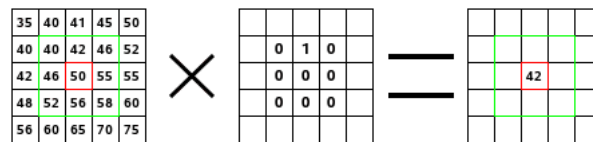
What is a convolution matrix? It's possible to get a rough idea of it without using mathematical tools that only a few ones know. Convolution is the treatment of a matrix by another one which is called "kernel".

The Convolution Matrix filter uses a first matrix which is the Image to be treated. The image is a bi-dimensional collection of pixels in rectangular coordinates. The used kernel depends on the effect you want.

GIMP uses 5x5 or 3x3 matrices. We will consider only 3x3 matrices, they are the most used and they are enough for all effects you want. If all border values of a kernel are set to zero, then system will consider it as a 3x3 matrix.

The filter studies successively every pixel of the image. For each of them, which we will call the "initial pixel", it multiplies the value of this pixel and values of the 8 surrounding pixels by the kernel corresponding value. Then it adds the results, and the initial pixel is set to this final result value.

A simple example:



On the left is the image matrix: each pixel is marked with its value. The initial pixel has a red border. The kernel action area has a green border. In the middle is the kernel and, on the right is the convolution result.

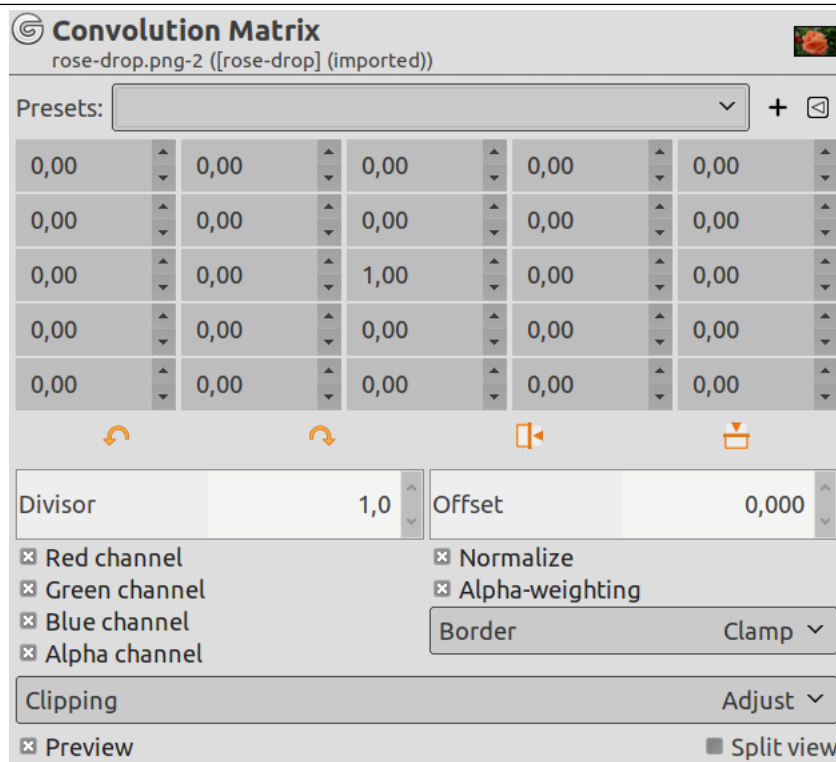
Here is what happened: the filter read successively, from left to right and from top to bottom, all the pixels of the kernel action area. It multiplied the value of each of them by the kernel corresponding value and added results. The initial pixel has become 42: $(40*0)+(42*1)+(46*0) + (46*0)+(50*0)+(55*0) + (52*0)+(56*0)+(58*0) = 42$. (the filter doesn't work on the image but on a copy). As a graphical result, the initial pixel moved a pixel downwards.

17.9.2.2 Activating the filter

This filter is found in the image window menu under Filters → Generic → Convolution Matrix...

17.9.2.3 Options

Figure 17.166 “Convolution matrix” options

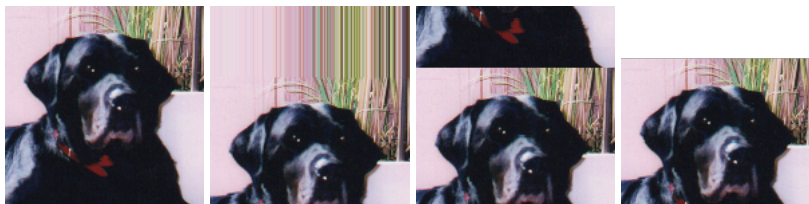


Matrix This is the 5x5 kernel matrix: you enter wanted values directly into boxes.

Divisor The result of previous calculation will be divided by this divisor. You will hardly use 1, which lets result unchanged, and 9 or 25 according to matrix size, which gives the average of pixel values.

Offset This value is added to the division result. This is useful if result may be negative. This offset may be negative.

Border When the initial pixel is on a border, a part of kernel is out of image. You have to decide what filter must do:



From left: source image, Extend border, Wrap border, Crop border

Extend This part of kernel is not taken into account.

Wrap This part of kernel will study pixels of the opposite border, so pixels disappearing from one side reappear on the other side.

Crop Pixels on borders are not modified, but they are cropped.

Channels You can select there one or several channels the filter will work with.

Normalise If this option is checked, The Divisor takes the result value of convolution. If this result is equal to zero (it's not possible to divide by zero), then a 128 offset is applied. If it is negative (a negative color is not possible), a 255 offset is applied (inverts result).

Alpha-weighting If this option is not checked, the filter doesn't take in account transparency and this may be cause of some artefacts when blurring.

17.9.2.4 Examples

Design of kernels is based on high levels mathematics. You can find ready-made kernels on the Web. Here are a few examples:

Figure 17.167 Sharpen

0	0	0	0	0
0	0	-1	0	0
0	-1	5	-1	0
0	0	-1	0	0
0	0	0	0	0



Figure 17.168 Blur

0	0	0	0	0
0	1	1	1	0
0	1	1	1	0
0	1	1	1	0
0	0	0	0	0



Figure 17.169 Edge enhance

	0	0	0	
	-1	1	0	
	0	0	0	

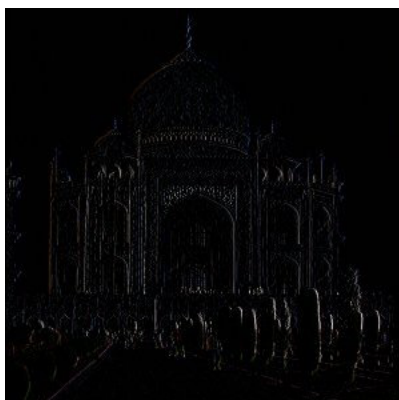
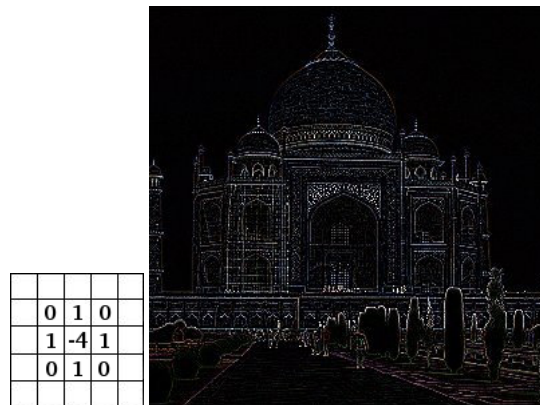
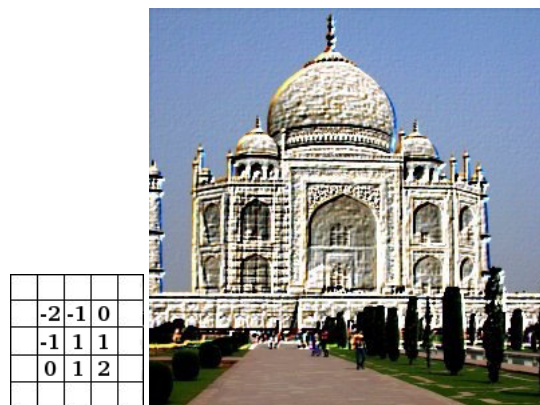


Figure 17.170 Edge detect**Figure 17.171** Emboss

17.9.3 Distance Map

17.9.3.1 Overview

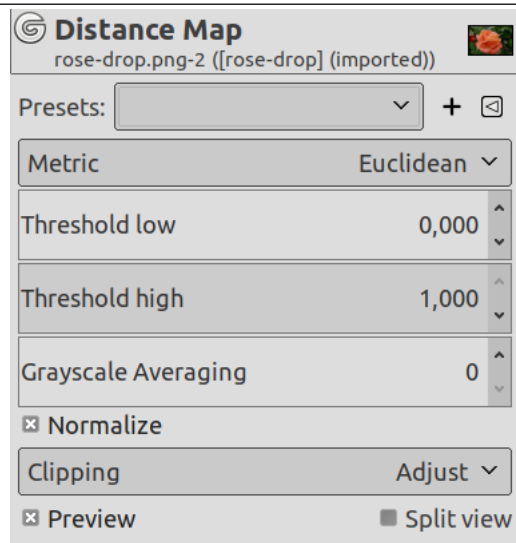
Each pixel in the image is replaced with a gray value dependent on the distance to the nearest obstacle pixel, generally a boundary pixel. Different methods can be used to calculate the distance.

17.9.3.2 Activating the filter

This filter is found in the image window menu under Filters → Generic → Distance Map....

17.9.3.3 Options

Figure 17.172 “Distance Map” options



Presets, Preview, Split view

Note

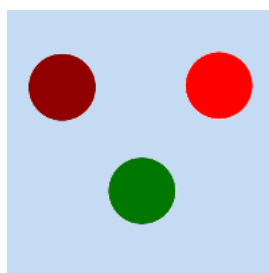


These options are described in Section [17.2](#).

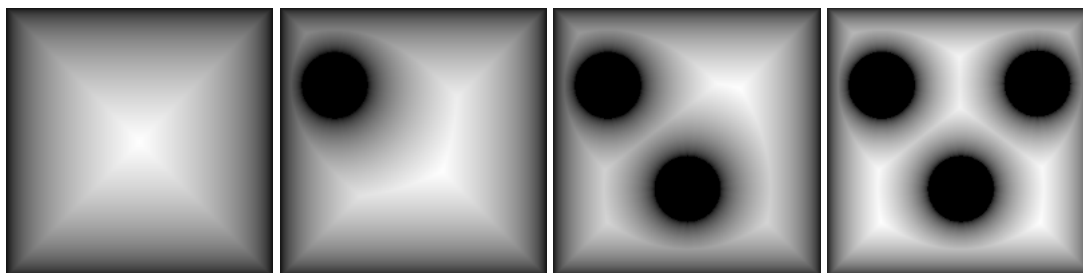
Metric “Metric” is a topology term. Three methods are available:

- Euclidean default: the distance is a line.
- Manhattan
- Chebyshev

Threshold low Default is 0. Increasing this value selects higher lightness pixels



Original image for examples. Threshold low will be progressively increased. Lightness: dark red = 0.070; bright red = 0.223; green = 0.133

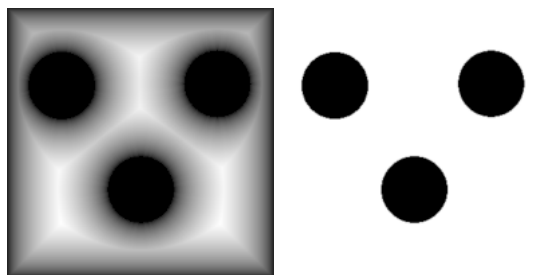
Figure 17.173 “Threshold low” example

(a) *Threshold low = 0: only border distances are visible.* (b) *Threshold low = 0.070: “dark red” circle appears.* (c) *Threshold low = 0.133: “green” circle appears.* (d) *Threshold low = 0.223: “bright red” circle appears.*

Threshold high Default is 100. Decreasing this value makes result lighter.

Grayscale Averaging Number of computations for grayscale averaging.

Normalize This option is checked by default. If you uncheck it, no blur is created.

Figure 17.174 “Normalize” example

(a) *Normalize option checked.* (b) *Normalize option unchecked.*

Clipping The result of this filter can be larger than the original image. With the default Adjust option, the layer will be automatically resized as necessary when the filter is applied. With the Clip option the result will be clipped to the layer boundary.

17.9.3.4 Using Distance Map filter

Searching for an example using Distance map filter in image processing...

17.9.4 GEGL graph

17.9.4.1 Overview

Not working.

17.9.4.2 Activating the filter

This filter is found in the image window menu under Filters → Generic → GEGL graph....

17.9.4.3 Options

Figure 17.175 “Distance Map” options



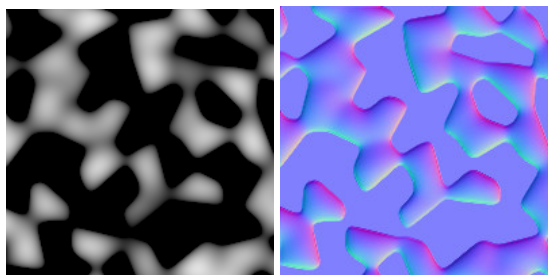
17.9.5 Normal Map

17.9.5.1 Overview

This filter generates a *normal map* from a *height map*. It's early initial work and a lot more is expected to be done.

We will use an height map created with Section [17.14.8](#):

Figure 17.176 Normal Map Example



(a) The height map

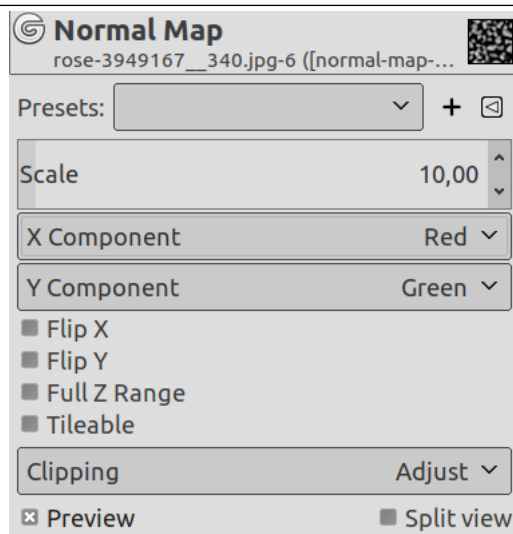
(b) Filter applied with default options, giving the Normal Map

17.9.5.2 Activating the filter

This filter is found in the image window menu under Filters → Generic → Normal Map...

17.9.5.3 Options

Figure 17.177 “Normal Map” options



Presets, Preview, Split view

Note



These options are described in Section [17.2](#).

Scale The amount by which to scale the heights values: increase or decrease bumps.

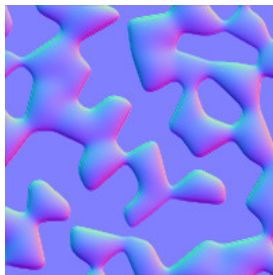


Scale = 2

X, Y Component The component used for X, Y coordinates: you can choose between the three RGB colors for the bumps.

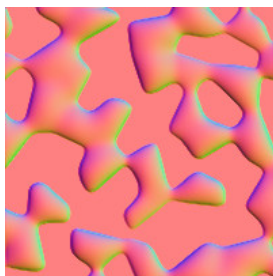
Note that if you change these values, new colors are added to the existing colors, giving the complementary colors.

Flip X, Y Flip the X, Y coordinates: flip bumps colors, horizontally and vertically. Bumps have a clear border and an opposite dark border, giving a feeling that light comes from a certain direction. To see bumps instead of hollows, light must come from the upper left corner; play with Flip X and Flip Y to get this lighting.



After playing with Flip X and Flip Y

Full Z Range Use the full [0, 1] range to encode the Z coordinates: You can get a more abrupt color gradient.



TQDO

Tileable Generate a tileable map:

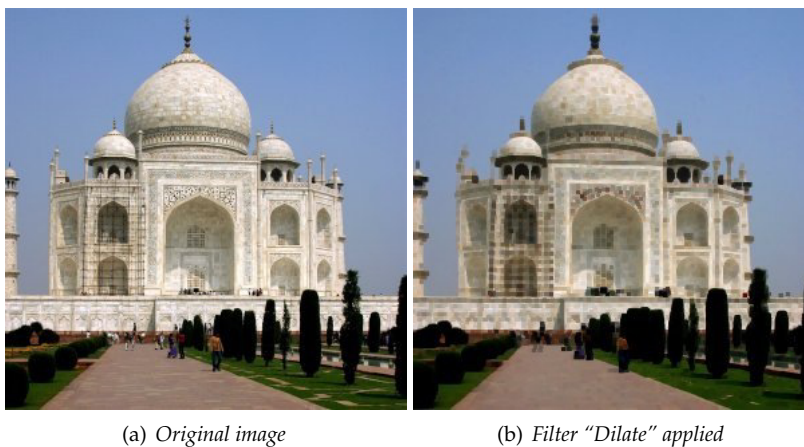
TODO

Clipping The result of this filter can be larger than the original image. With the default Adjust option, the layer will be automatically resized as necessary when the filter is applied. With the Clip option the result will be clipped to the layer boundary.

17.9.6 Dilate

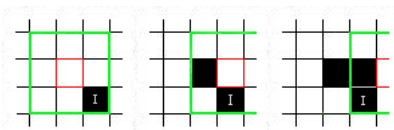
17.9.6.1 Overview

Figure 17.178 Applying example for the Dilate filter



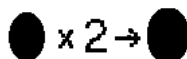
This filter widens and enhances dark areas of the active layer or selection.

For every image pixel, it brings the pixel Value (luminosity) into line with the lowest Value (the darkest) of the 8 neighbouring pixels (3x3 matrix). So, a dark pixel is added around dark areas. An isolated pixel on a brighter background will be changed to a big “pixel”, composed of 9 pixels, and that will create some noise in the image.



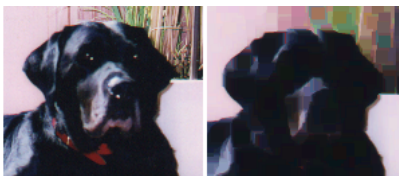
In this image, the studied pixel has a red border and the studied matrix has a green border. I hope you have understood how to go on with the process and get a 3x3 pixel block: when the “I” pixel is inside the green border, the studied pixel turns to black.

A larger dark area will dilate by one pixel in all directions:



The filter was applied 3 times.

On more complex images, dark areas are widened and enhanced the same, and somewhat pixellated. Here, the filter was applied 3 times:



Of course, if background is darker than foreground, it will cover the whole image.

17.9.6.2 Activating the filter

This filter is found in the image window menu under Filters → Generic → Dilate.

17.9.6.3 Examples

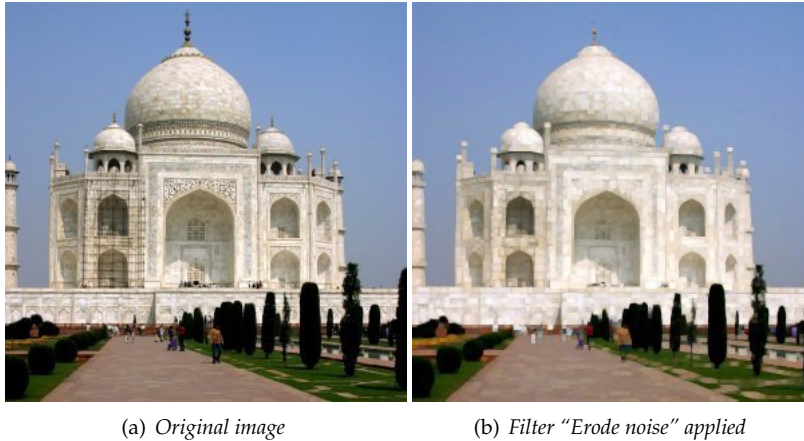
Figure 17.179 Dilate text



Figure 17.180 Dilate neon effect

17.9.7 Erode

17.9.7.1 Overview

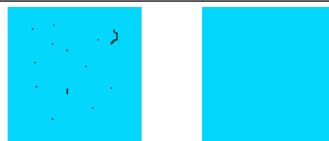
Figure 17.181 Erode noise

This filter widens and enhances bright areas of the active layer or selection.

For every image pixel, it brings the pixel Value (luminosity) into line with the upper value (the brightest) of the 8 neighbouring pixels (3x3 matrix). So, a bright pixel is added around bright areas. An isolated pixel on a brighter background will be deleted. A larger bright area will dilate by one pixel in all directions.

On complex images, bright areas are widened and enhanced the same, and somewhat pixellated.

On a solid background, this filter can delete noise:

Figure 17.182 "Erode noise" example

17.9.7.2 Activating the filter

This filter is found in the image window menu under Filters → Generic → Erode.

17.10 Combine Filters

17.10.1 Introduction

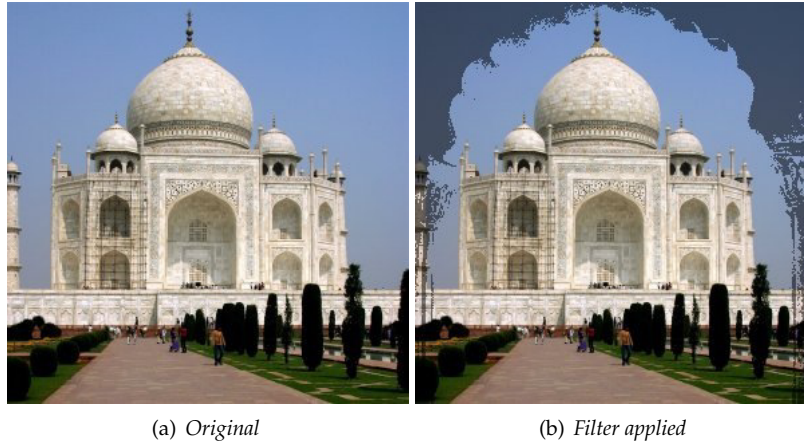
The combine filters associate two or more images into a single image.

17.10.2 Depth Merge

Depth Merge is a Combine Filter which is useful to combine two different pictures or layers. You can decide which part of every image or layer will stay visible.

17.10.2.1 Overview

Figure 17.183 Filter example



Every image is associated with a map which works as a mask. Simply create this map as a grayscale gradient: when applied onto the image, dark areas of the mask will show the underlying image and bright areas will mask the image.

Note



To work with this filter, images and maps must have the same size. All images to be selected must be present on screen.

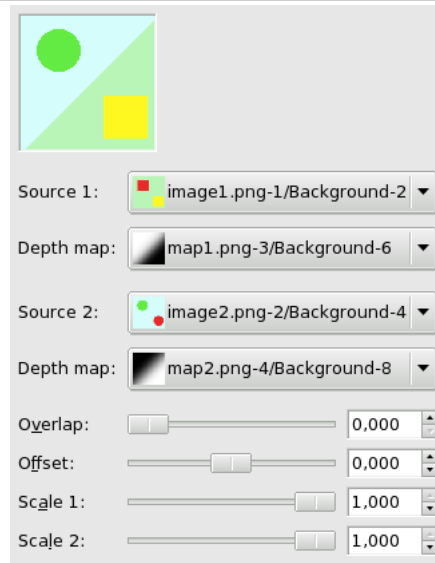
You can also use this filter on an image with several layers. All layers will appear in the drop-down lists used to select images. These layers must have the same size.

17.10.2.2 Accessing this Filter

You can find this filter through Filters → Combine → Depth Merge...

17.10.2.3 Options

Figure 17.184 “Depth Merge” filter options



Source 1, Source 2 Defines the source images to use for the blending.

Depth map Define the picture to use as transformation maps for the sources.

Overlap Creates soft transitions between images.

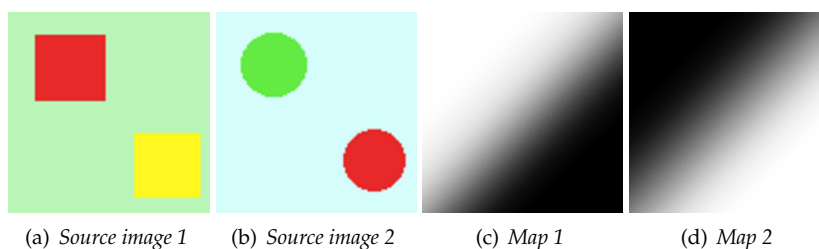
Offset This option shifts the merging limit, giving more or less importance to an image against the other.

Scale 1, Scale 2 Same as above for Offset, but more sensitive and applied to each map separately. When you scale to a lower value, it will affect the map image's value, making it darker. So, black is more dominant in the merge and you will see more of the image.

17.10.2.4 Using example

Maps are grayscale gradients created with the **Gradient tool** and modified with the **Curve tool**.

Figure 17.185 Source images and their maps



(a) Source image 1

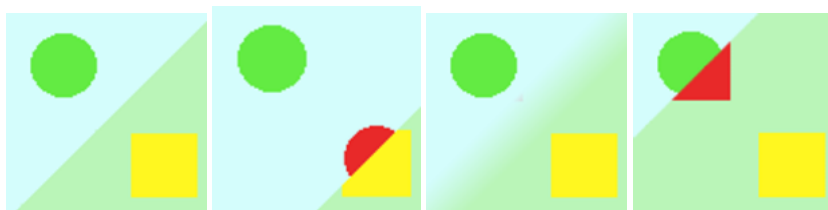
(b) Source image 2

(c) Map 1

(d) Map 2

You can understand what's going on. Image-1 is treated by map-1: the red square is masked and the yellow square remains visible. Image-2 is treated by map-2: the red circle is masked and the green circle remains visible. In total, the green circle and the yellow square stay visible.

Figure 17.186 Results

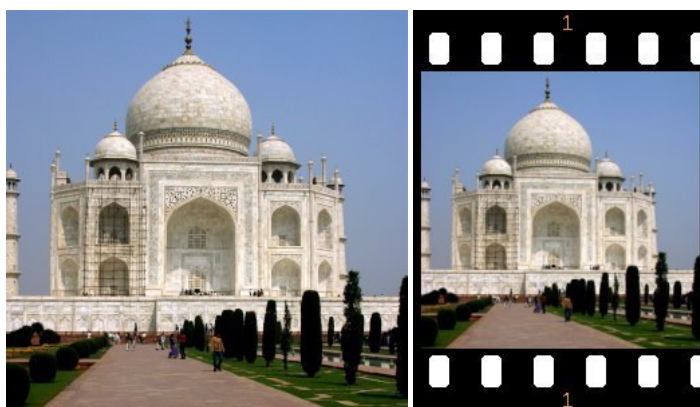


(a) No offset and no overlap. The limit between both images is sharp and is situated in the middle of the mask gradient.
 (b) Offset = 0.980 : the limit, sharp, is shifted so blurred.
 (c) Overlap: the limit is blurred.
 (d) Scale 1 reduced to 0.056 : as with Offset, the limit is shifted. Image-1 area is increased.

17.10.3 Filmstrip

17.10.3.1 Overview

Figure 17.187 Applying example for the Filmstrip filter



(a) Original image

(b) Filter "Filmstrip" applied

Filmstrip filter lets you merge several pictures into a photographic film drawing.

Note



This filter does not invert colors, so it does not imitate negative film like the ones used to produce prints. Instead you should think of the result as an imitation of slide film or cinema film.

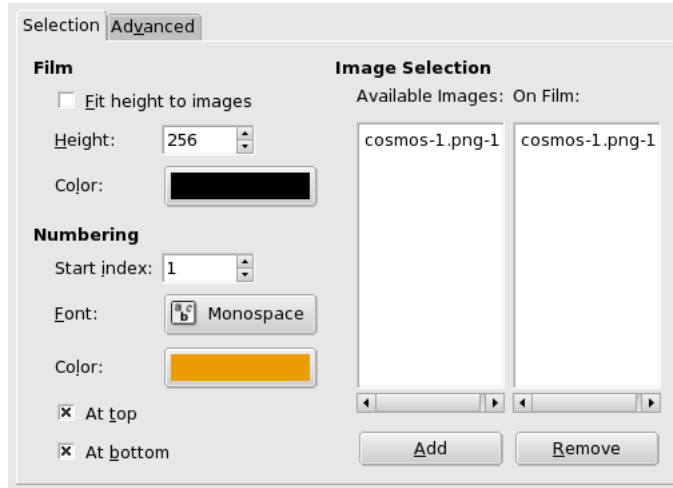
17.10.3.2 Accessing this Filter

You can find this filter through Filters → Combine → Filmstrip....

17.10.3.3 Options

17.10.3.3.1 Selection

Figure 17.188 “Filmstrip” filter options (Selection)



Filmstrip

Fit height to images Applies the height of original pictures to the resulting one.

Height This option lets you define the height of the resulting picture. If originals have different sizes, they will be scaled to this size.

Color By clicking on the color dwell you can define the color of the film (around and between pictures).

Numbering

Start index Defines the beginning number which will be used for the images.

Font Defines the font of digits.

Color By clicking on the color dwell, you can define the font color of digits.

At top, At bottom Defines the position of the number.

Image Selection

Available images Shows the pictures which can be used for merging. The pictures are the ones already opened in GIMP.

On film Shows the pictures chosen to be merged.

Add This button allows the user to put an available image in the “On film” section.

Remove This button allows to bring a picture from “On film ” to “Available images”. After that, the picture will not be used anymore in the resulting document.

17.10.3.3.2 Advanced

Figure 17.189 “Filmstrip” filter options (Advanced)

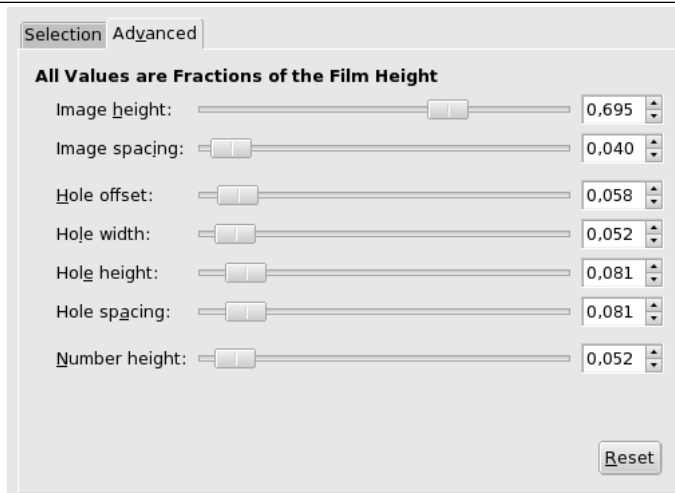


Image height Defines the height of each pictures in the resulting image.

Image spacing Defines the space between the pictures as they will be inserted in the future image.

Hole offset Defines the hole position from image border.

Hole width Defines the width of the holes in the resulting image.

Hole height Defines the height of the holes in the resulting image.

Hole spacing Defines the space between holes

Number height Defines the height of the index number, proportionally to the height of the picture.

17.11 Artistic Filters

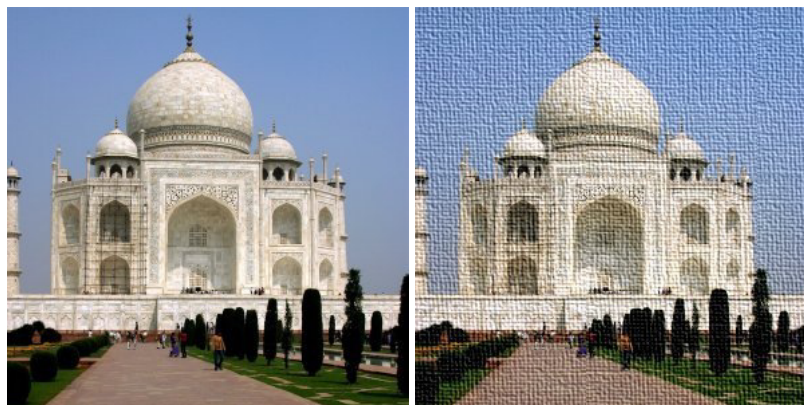
17.11.1 Introduction

Artistic filters create artistic effects like cubism, oil painting, canvas...

17.11.2 Apply Canvas

17.11.2.1 Overview

Figure 17.190 Example for the “Apply Canvas” filter



(a) Original image

(b) Filter “Apply Canvas” applied

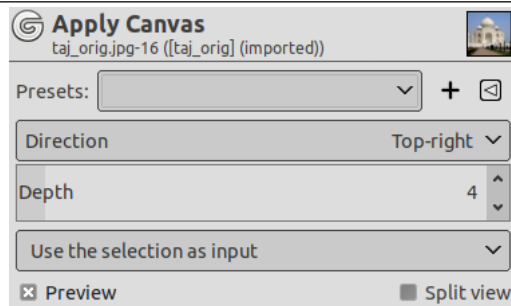
This filter applies a canvas-like effect to the current layer or selection. It textures the image as if it were an artist's canvas.

17.11.2.2 Activate the filter

You can find this filter through Filters → Artistic → Apply Canvas....

17.11.2.3 Options

Figure 17.191 “Apply Canvas” options



Presets, Preview, Split view

Note



These options are described in Section [17.2](#).

Direction Direction sets the starting direction of the canvas render. You can also consider that this option gives you the position of the light source which lightens the canvas.

Depth The Depth slider controls the apparent depth of the rendered canvas effect from 1 (very flat) to 50 (very deep).

Use the selection as input, Use the entire layer as input

Note

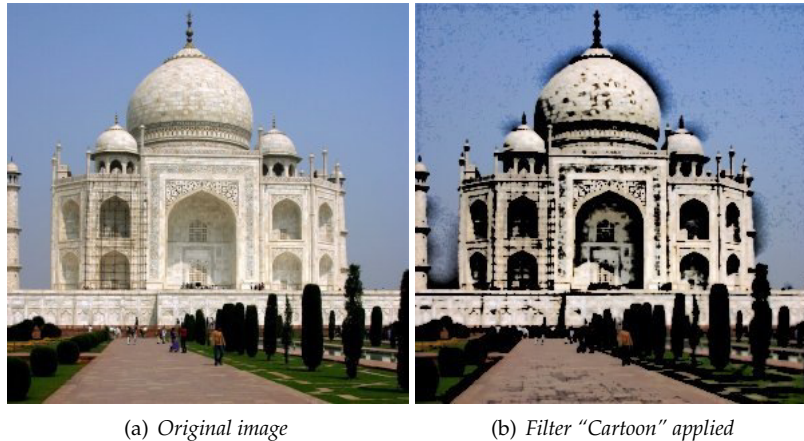


These options are described in Section [17.2](#).

17.11.3 Cartoon

17.11.3.1 Overview

Figure 17.192 Example for the “Cartoon” filter



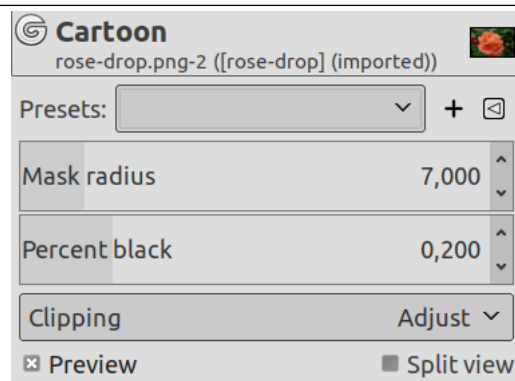
The Cartoon filter modifies the active layer or selection so that it looks like a cartoon drawing. Its result is similar to a black felt pen drawing subsequently shaded with color. This is achieved by darkening areas that are already distinctly darker than their neighborhood.

17.11.3.2 Activate the filter

You can find this filter in Filters → Artistic → Cartoon....

17.11.3.3 Options

Figure 17.193 “Cartoon” filter options



Presets, Preview, Split view

Note



These options are described in Section 17.2.

Mask radius This parameter controls the size of areas the filter works with. Large values result in very thick black areas and much less detail in the resulting image. Small values result in more subtle pen strokes and more details preserved.

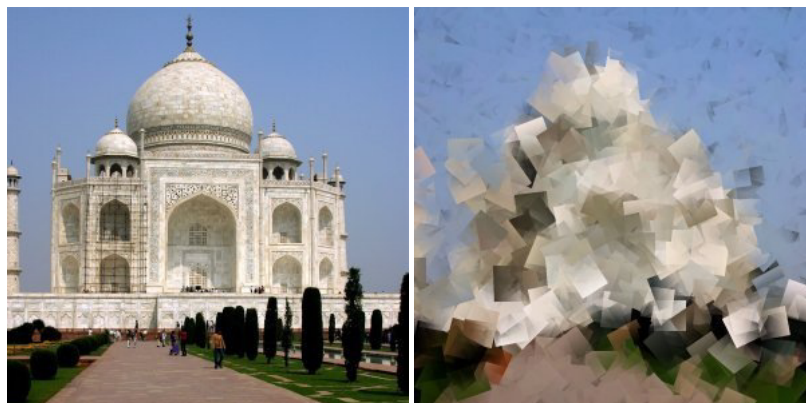
Percent black This parameter controls the amount of black color added to the image. Small values make the blend from color regions to blackened areas smoother and dark lines themselves thinner and less noticeable. Larger values make the lines thicker, darker and sharper. The maximum value makes the lines aliased. The best, most natural results are usually achieved with an intermediate value.

Clipping The result of this filter can be larger than the original image. With the default Adjust option, the layer will be automatically resized as necessary when the filter is applied. With the Clip option the result will be clipped to the layer boundary.

17.11.4 Cubism

17.11.4.1 Overview

Figure 17.194 Example for the “Cubism”



(a) Original image

(b) Filter “Cubism” applied

The Cubism plug-in modifies the image so that it appears to be constructed of small squares of semi-transparent tissue paper.

Tip



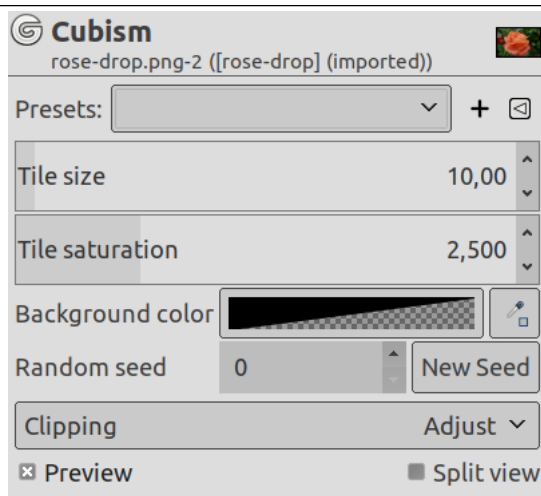
If setting possibilities of this filter are not enough for you, see [GIMPpressionist](#) filter which offers more options.

17.11.4.2 Activate the filter

You can find this filter through Filters → Artistic → Cubism...

17.11.4.3 Options

Figure 17.195 “Cubism” filter options



Presets, Preview, Split view

Note



These options are described in Section 17.2.

Tile size This variable determines the size, in pixels, of the squares to be used. This is, in effect, the size of the little squares of tissue paper used in generating the new image. The slider can be used, the exact pixel size can be entered into the text box, or the arrow buttons can be used.

Tile saturation This variable specifies how intense the color of the squares should be. This affects the opacity of the squares. A high value will render the squares very intensely and does not allow lower squares to show through. A lower value allows the lower squares to be more visible through the higher ones and causes more blending in the colors. If this is set to 0 and Use Background Color is not checked, the entire layer will be rendered black. If it is checked and the value here is zero, the background color will fill the entire layer.

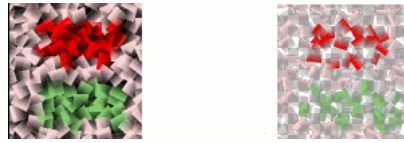
Use background color This filter creates its tiles from all the colors of the image and paint them with a color scale which depends on the Tile Saturation. With a low Tile Saturation, this color scale lets the background color appear: default is black as you can see by setting Tile Saturation to 0. When this option is checked, the background color of the Toolbox is used. If your image has an Alpha channel, this color scale will also be transparent.

Figure 17.196 Example illustrating the action of the “Use BackGround color” option



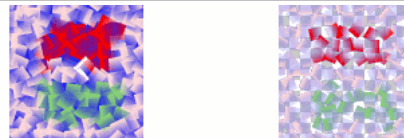
The original image and the color area of Toolbox. BG color is blue.

Figure 17.197 The option is not checked



The option is not checked. On the left is no Alpha: background is black. On the right is Alpha: background is transparent black.

Figure 17.198 The option is checked



The option is checked. On the left, no Alpha: background is blue. On the right, with an Alpha channel, background is transparent blue.

Clipping The result of this filter can be larger than the original image. With the default Adjust option, the layer will be automatically resized as necessary when the filter is applied. With the Clip option the result will be clipped to the layer boundary.

Tip

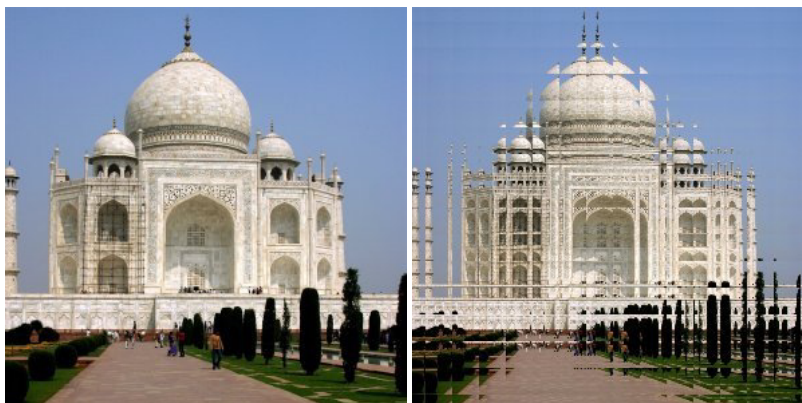


If you are using this to generate background images for web pages and the like, work with a small range of colors painted randomly on a small square. Then apply the Cubism filter with the desired settings. As a last step, try **Tile Seamless** to adjust the image so it will tile seamlessly in your background.

17.11.5 Glass Tile

17.11.5.1 Overview

Figure 17.199 The same image, before and after applying glass tile effect.



(a) Original image

(b) Filter "Glass Tile" applied

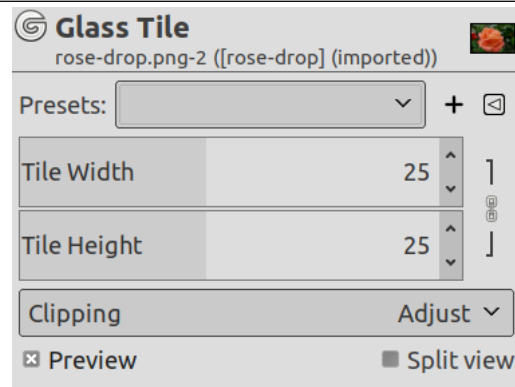
After applying this filter, the active layer or selection is rendered as through a glass brick wall.

17.11.5.2 Activate the filter

You can find this filter through Filters → Artistic → Glass Tile...

17.11.5.3 Options

Figure 17.200 “Glass Tile” filter options



Presets, Preview, Split view

Note



These options are described in Section 17.2.

Tile width, Tile height Sets tile width and length (10-50 pixels).

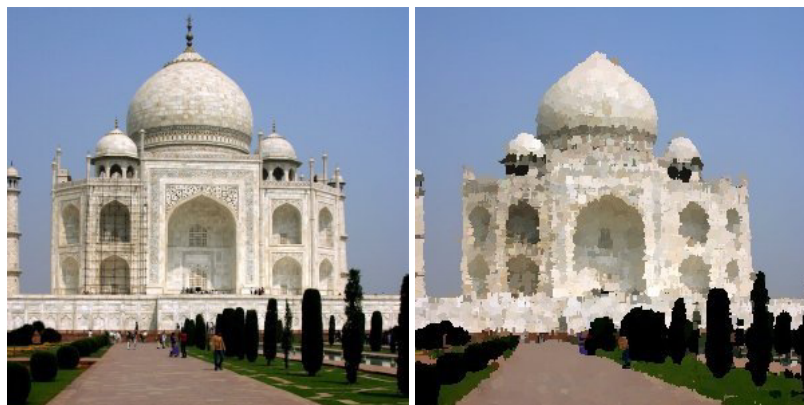
By default, width and height are linked, indicated by the chain symbol next to the input boxes. If you want to set width and height separately, click on that chain symbol to unlink them.

Clipping The result of this filter can be larger than the original image. With the default Adjust option, the layer will be automatically resized as necessary when the filter is applied. With the Clip option the result will be clipped to the layer boundary.

17.11.6 Oilify

17.11.6.1 Overview

Figure 17.201 Example for the “Oilify” filter



(a) Original image

(b) Filter “Oilify” applied

This filter makes the image look like an oil painting. The Mask size controls the outcome: a high value gives the image less detail, as if you had used a larger brush.

Tip



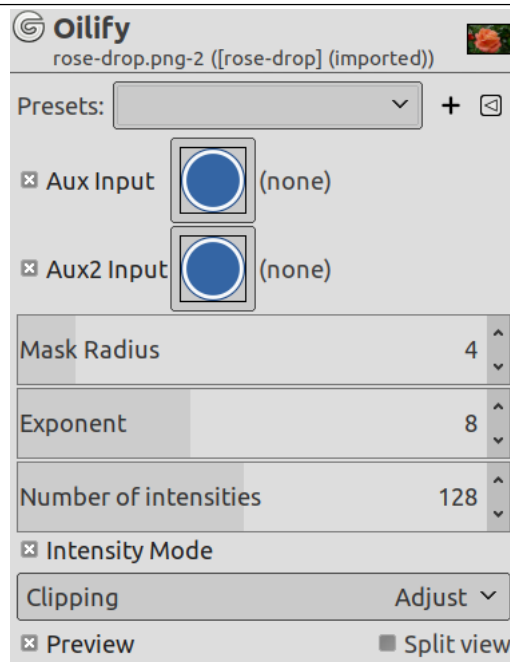
The GIMPpressionist filter can produce similar effects, but allows a much wider variety of options.

17.11.6.2 Activate the filter

This filter is found in the image menu through Filters → Artistic → Oilify....

17.11.6.3 Options

Figure 17.202 “Oilify” filter options



Presets, Preview, Split view

Note



These options are described in Section [17.2](#).

Mask radius Mask radius selects the size of the brush mask used to paint the oily render. Larger values here produce an oilier render.

Exponent Exponent selects density of the brush mask used to paint the oily render.

Number of intensities Size of the histogram: default is 128. Reducing the number of intensities results in a loss of details.

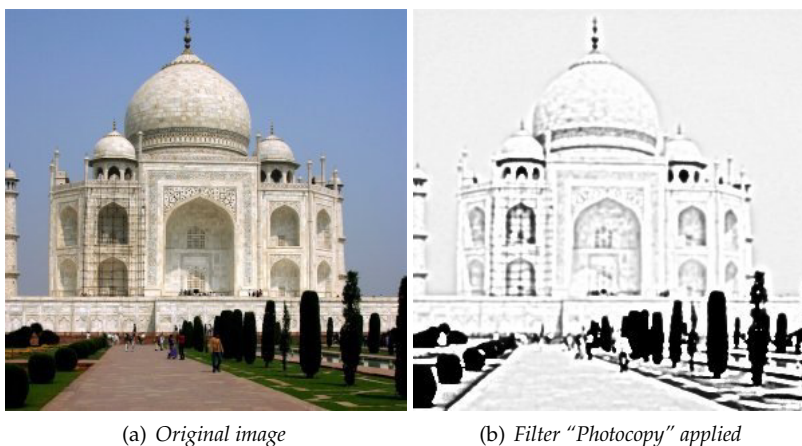
Intensity mode Use pixel luminance values: to test.

Clipping The result of this filter can be larger than the original image. With the default Adjust option, the layer will be automatically resized as necessary when the filter is applied. With the Clip option the result will be clipped to the layer boundary.

17.11.7 Photocopy

17.11.7.1 Overview

Figure 17.203 Example for the “Photocopy” filter



The Photocopy filter modifies the active layer or selection so that it looks like a black and white photocopy, as if toner transferred was based on the relative darkness of a particular region. This is achieved by darkening areas of the image which are measured to be darker than a neighborhood average, and setting other pixels to white.

Tip



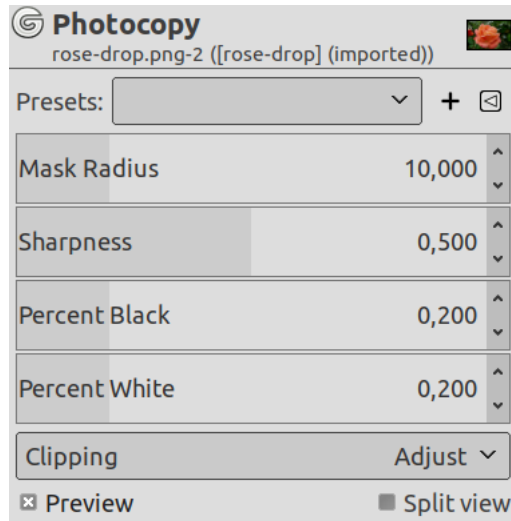
You may use this filter to sharpen your image. Create a copy of the active layer and use the filter on the copy. Set the **Layer Mode** to Multiply and adjust the opacity slider to get the best result.

17.11.7.2 Starting filter

You can find this filter from the image menu through Filters → Artistic → Photocopy....

17.11.7.3 Options

Figure 17.204 “Photocopy” filter options



Presets, Preview, Split view

Note



These options are described in Section [17.2](#).

Mask radius This parameter controls the size of the pixel neighbourhood over which the average intensity is computed and then compared to each pixel in the neighborhood to decide whether or not to darken it. Large values result in very thick black areas bordering the regions of white and much less detail for black areas. Small values result in less toner overall and more details everywhere.

Sharpness With this option, you can set photocopy sharpness, from 0.0 to 1.0.

Percent black This parameter controls the amount of black color added to the image. Small values make the blend from color regions to blackened areas smoother and dark lines themselves thinner and less noticeable. Larger values make the lines thicker, darker and sharper. The maximum value makes the lines aliased. The best, most natural results are usually achieved with an intermediate value. Values vary from 0.0 to 1.0.

Percent white This parameter increases white pixels percentage.

Clipping The result of this filter can be larger than the original image. With the default Adjust option, the layer will be automatically resized as necessary when the filter is applied. With the Clip option the result will be clipped to the layer boundary.

17.11.8 Simple Linear Iterative Clustering (SLIC)

17.11.8.1 Overview

This filter creates superpixels based on k-means clustering.

Superpixels are small cluster of pixels that share similar properties. Superpixels simplifies images with a great number of pixels making them more easy to be treated in many domains (computer vision, pattern recognition and machine intelligence). GIMP’s aim is more humble: create a posterization effect.

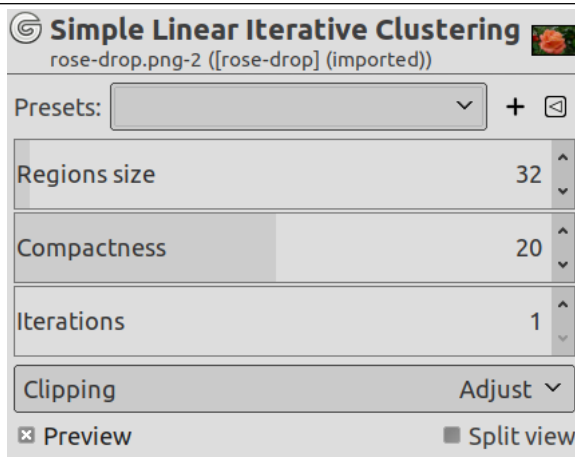
k-means clustering is one of the most used algorithms to create superpixels. Superpixel color is the mean of pixels color in the corresponding region.

17.11.8.2 Activating the filter

This filter is found in the image window menu under Filters → Artistic → Simple Linear Iterative Clustering....

17.11.8.3 Options

Figure 17.205 “Simple Linear Iterative Clustering” options



Presets, Preview, Split view

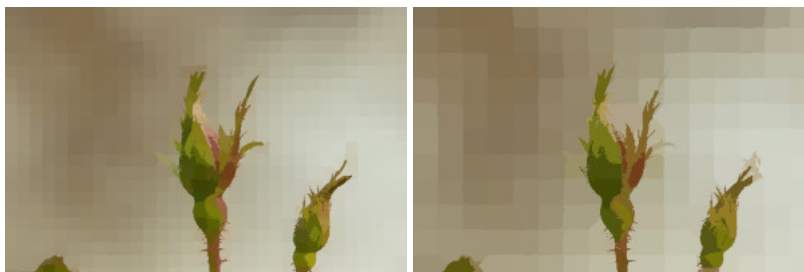
Note



These options are described in Section 17.2.

Regions size Increasing regions size collects more pixels, and so superpixels size increases also.

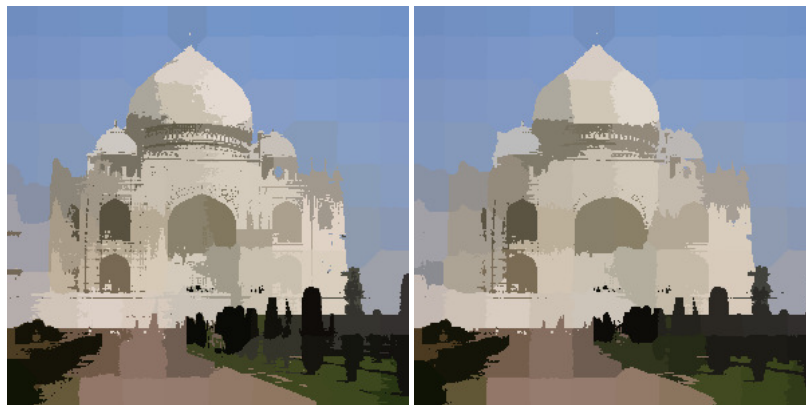
Figure 17.206 “Regions size” example



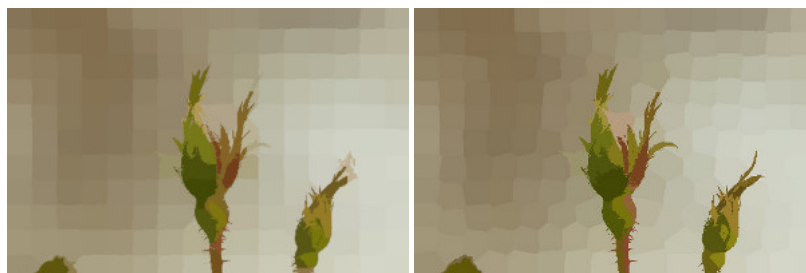
(a) *Regions size* = 16

(b) *Regions size* = 32

Compactness Superpixels borders may be irregular. Increasing this option gives superpixels more regular border.

Figure 17.207 “Compactness” example(a) *Compactness = 20*(b) *Compactness = 40: look at the dome.*

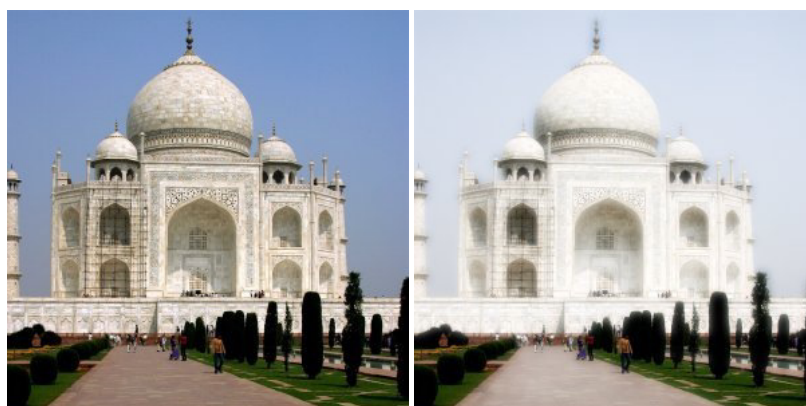
Iterations How many times filter is repeated. Increasing this value gives more details.

Figure 17.208 “Regions size” example(a) *Iterations = 1 (default)*(b) *Iterations = 15*

Clipping The result of this filter can be larger than the original image. With the default Adjust option, the layer will be automatically resized as necessary when the filter is applied. With the Clip option the result will be clipped to the layer boundary.

17.11.9 Softglow

17.11.9.1 Overview

Figure 17.209 Example for the “SoftGlow” filter(a) *Original image*(b) *Filter “Softglow” applied*

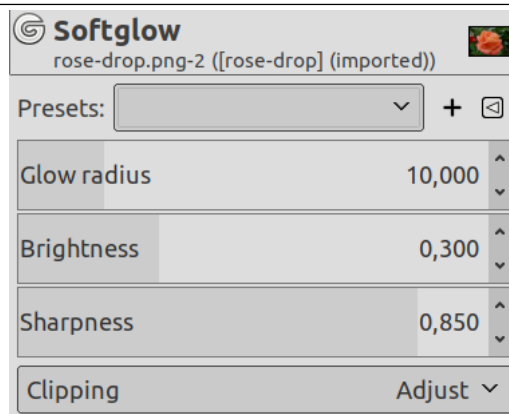
This filter lights the image with a soft glow, like the old trick smearing vaseline on the lens. Softglow produces this effect by making bright areas of the image brighter.

17.11.9.2 Starting filter

You can find this file in the Image menu through: Filters → Artistic → Softglow....

17.11.9.3 Options

Figure 17.210 “Softglow” filter options



Presets, Preview, Split view

Note



These options are described in Section 17.2.

Glow radius The glow radius parameter controls the sharpness of the effect, giving a “vaseline-on-the-lens” effect.

Brightness The brightness parameter controls the degree of intensification applied to image highlights.

Sharpness The sharpness parameter controls how defined or alternatively diffuse the glow effect should be.

Clipping The result of this filter can be larger than the original image. With the default Adjust option, the layer will be automatically resized as necessary when the filter is applied. With the Clip option the result will be clipped to the layer boundary.

17.11.10 Waterpixels

17.11.10.1 Overview

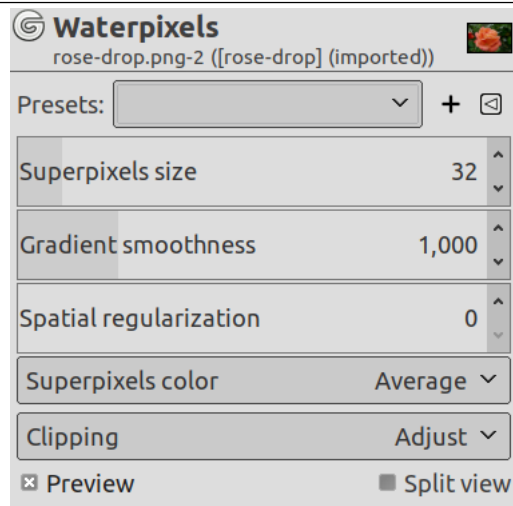
Superpixels based on the watershed transformation.

17.11.10.2 Activating the filter

This filter is found in the image window menu under Filters → Artistic → Waterpixels....

17.11.10.3 Options

Figure 17.211 “Waterpixels” options



Presets, Preview, Split view

Note



These options are described in Section [17.2](#).

Superpixels size TODO

Gradient smoothness TODO

Spatial regularization TODO

Superpixels color TODO

Clipping The result of this filter can be larger than the original image. With the default Adjust option, the layer will be automatically resized as necessary when the filter is applied. With the Clip option the result will be clipped to the layer boundary.

17.11.11 Cartoon (legacy)

17.11.11.1 Overview

Figure 17.212 Example for the “Cartoon (legacy)” filter



(a) Original image

(b) Filter “Cartoon(legacy)” applied

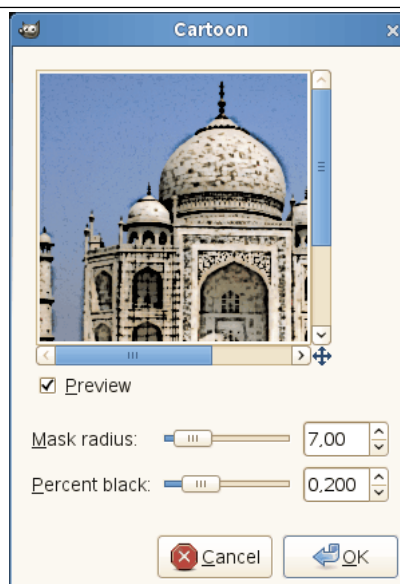
The Cartoon filter modifies the active layer or selection so that it looks like a cartoon drawing. Its result is similar to a black felt pen drawing subsequently shaded with color. This is achieved by darkening areas that are already distinctly darker than their neighborhood.

17.11.11.2 Activate the filter

You can find this filter in Filters → Artistic → Cartoon (legacy)....

17.11.11.3 Options

Figure 17.213 “Cartoon” filter options



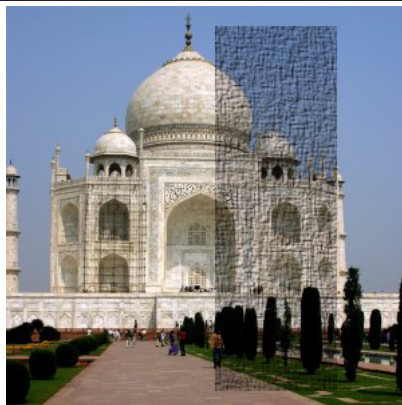
Mask radius This parameter controls the size of areas the filter works with. Large values result in very thick black areas and much less detail in the resulting image. Small values result in more subtle pen strokes and more details preserved.

Percent black This parameter controls the amount of black color added to the image. Small values make the blend from color regions to blackened areas smoother and dark lines themselves thinner and less noticeable. Larger values make the lines thicker, darker and sharper. The maximum value makes the lines aliased. The best, most natural results are usually achieved with an intermediate value.

17.11.12 Clothify

17.11.12.1 Overview

Figure 17.214 Example of Clothify



Filter "Clothify" applied (in selection)

Clothify command is a script which adds a cloth-like texture to the selected region or alpha.

If the image is in indexed colors, this menu entry is grayed out and unavailable.

This effect is achieved through the following steps:

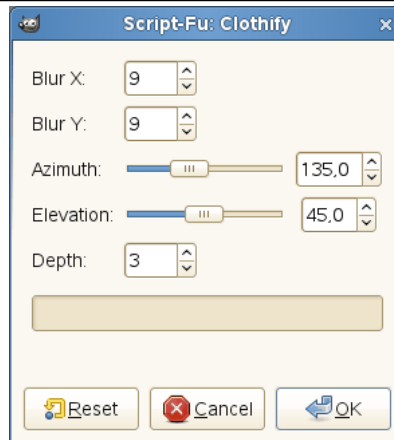
1. Create an image in the same size as the original image, or selection or region in alpha if it is given, then add a layer to this image filled with white and **noisified** strongly.
2. Reproduce a layer from the recently added layer and set the mode of the upper layer to **Multiply**.
3. Apply **Gaussian blur** in different directions, horizontally on the lower layer by the given parameter Blur X as the radius, and vertically on the upper layer with Blur Y.
4. Merge these two layers into an image and make its contrast **expanded as possibly**, then slightly noisify again on this working image.
5. Finally do **bump map** on the original image by the working image with parameters Azimuth, Elevation, and Depth.

17.11.12.2 Activate the filter

This filter is found in the image window menu under Filters → Artistic → Clothify....

17.11.12.3 Options

Figure 17.215 “Clothify” filter options



Azimuth, Elevation, and Depth come from **Bump Map** filter.

Blur X, Blur Y These parameters lengthen fibers of the texture, horizontally by Blur X, and vertically by Blur Y. The range of value is between 3 to 100.

Azimuth Azimuth slider controls the bearings where light comes from according to the point of the compass. Both the minimum value (0.00) and the maximum value (360.00) are the direction of three o’clock on the dial panel of an analogue clock. Increasing value goes counter-clockwise.

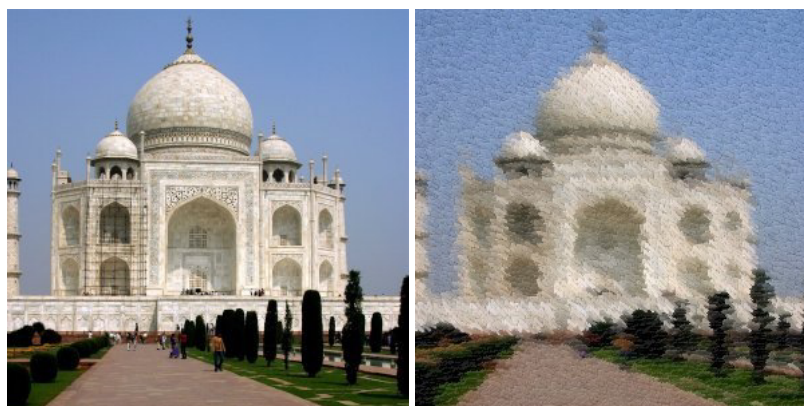
Elevation Elevation slider controls the height where light comes from. For the minimal value (0.50) the light comes from horizon, and for the maximum value (90.0) the light comes from zenith.

Depth Depth slider controls distance between bump height and hollow depth. Increasing value causes more rugged features. Values vary from 1 to 65.

17.11.13 GIMPressionist

17.11.13.1 Overview

Figure 17.216 Example for the “GIMPressionist” filter



(a) Original image

(b) Filter “GIMPressionist” applied

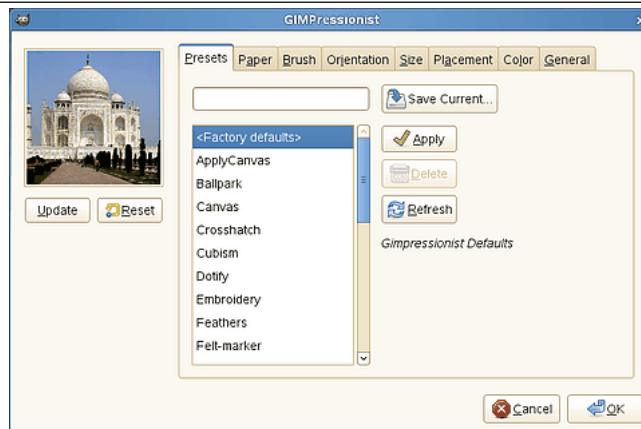
The GIMPressionist filter is the king of Artistic filters. It can do what **Cubism** and **Apply Canvas** do and much more. It gives your image the look of a painting. All is going as if your image was painted again on a paper and with a brush you’d have chosen. It works on the active layer or selection.

17.11.13.2 Activating the filter

You can find this filter via the image menu through Filters → Artistic → GIMPpressionist....

17.11.13.3 Options

Figure 17.217 GIMPpressionist options



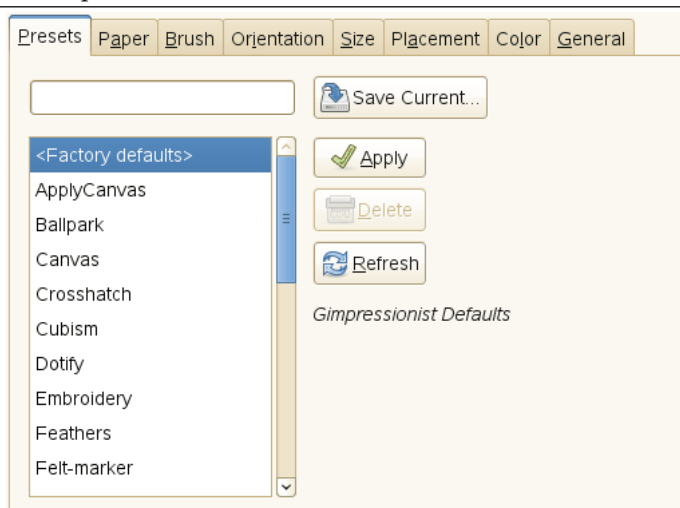
The dialog window consists of a small Preview area on the left, which is always visible, and a huge amount of GIMPpressionist options organized in tabs.

17.11.13.3.1 Preview

All your setting changes will appear in the Preview without affecting the image until you click on OK. The Update button refreshes the preview window (it is not automatic, GIMPpressionist has so much work to do!), and the Reset button reverts to the original image.

17.11.13.3.2 Presets tab

Figure 17.218 "Presets" tab options



GIMPpressionist has a lot of parameters. When combined, they give an astronomical number of possibilities. So, it is important, when an interesting preset has been found, to save it and also to send it to the plugin author if exceptional. Per contra, the intricacy of all these parameters makes difficult understanding and foreseeing how each one works.

Presets options

Save Current Save current parameters. You can give a name in the input box on the left and a short description in the dialog that appear.

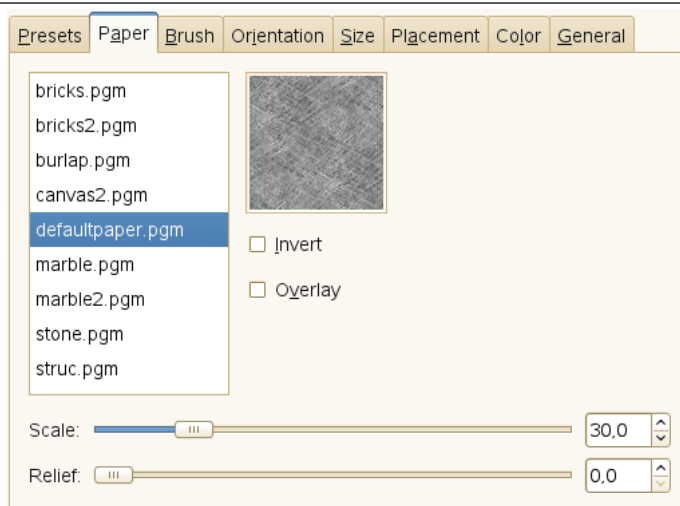
Apply Load the parameters of the selected preset in the list.

Delete Delete the selected preset. You can delete only the presets you have created.

Refresh Update the preset list.

17.11.13.3.3 Paper tab

Figure 17.219 “Paper” tab options



This tab concerns the texture of the canvas your image will be painted on. You have a list of textures and a Preview for the selected texture. A description is displayed on the right for every texture when selected.

Paper options

Invert Inverts the paper texture: what was a hollow turns to a bump and vice-versa.

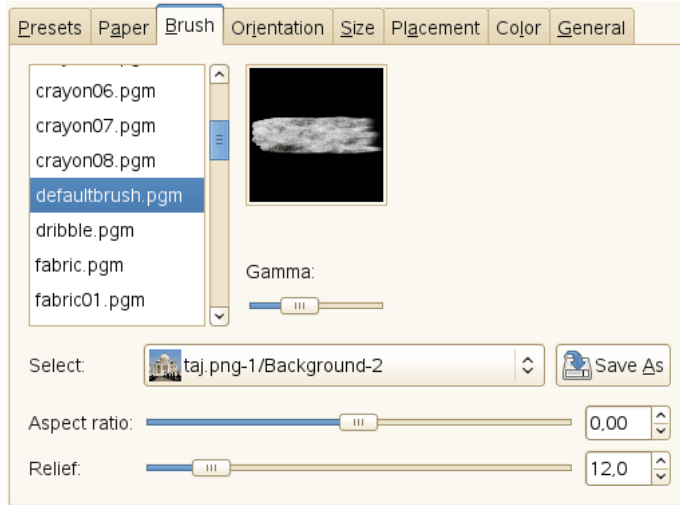
Overlay Apply the paper as it, without embossing it. It looks like if a transparent paper has been overlaid on the image.

Scale Specifies the scale of the texture (in % of the original file): controls the graininess of the texture.

Relief Specifies the amount of embossing to apply (3-150).

17.11.13.3.4 Brush tab

Figure 17.220 “Brush” tab options



“Brush” is a general term for any material used to paint. A list of brushes is available with a Preview for the selected one.

Brush options

Gamma Changes the gamma (luminosity) of the selected brush. The gamma correction brightens or darkens midtones.

Select You can also use a brush pattern you have created by selecting its image (arrow button on the Select line). This image must be on your screen before you launch the filter to be taken in account. Of course, don’t use big images.

If your image has several layers, they also will be displayed in the Select list and can be used as a brush. When selected, the layer appears in the brush preview and the normal brush is deselected.

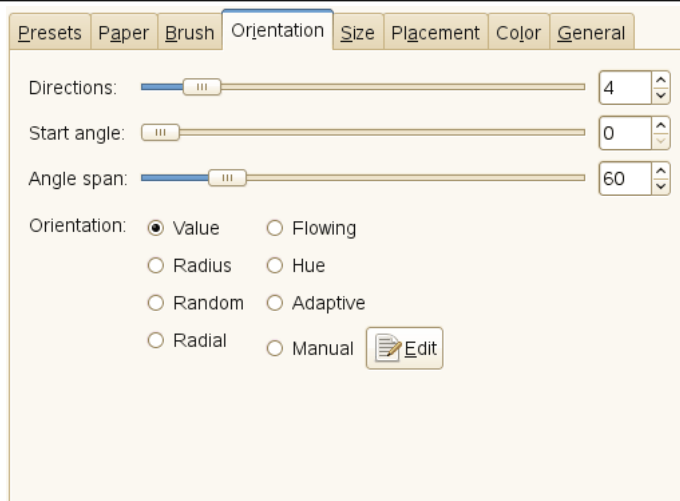
The Save as button allows you to save the selected brush.

Aspect ratio Specifies the brush proportions, height (0 -1) and width (0 +1).

Relief Specifies the amount of paint used for each stroke. This may evoke painting with a palette knife.

17.11.13.3.5 Orientation tab

Figure 17.221 “Orientation” tab options



This tab allows to set the orientation of the brush strokes. A painter is not obliged to go over with the same paintbrush angle. To perform some effects, he can vary their orientation.

Orientation options

Directions With this option, you can set how many times the brush will pass through a same place, with each time a different direction, resulting in a more and more thick paint.

Start angle Specifies the general direction of the strokes, the angle that the angle range will start from. Directions are often chosen to give some movement to the image.

Angle span Specifies the angle, the sector, of the stroke “fan”.

Orientation Specifies the direction of the brush strokes.

Value Let the value (luminosity) of the region determine the direction of the stroke.

Radius The distance from the center of the image determines the direction of the stroke.

Random Select a random direction for each stroke.

Radial Let the direction from the center determine the direction of the stroke.

Flowing Not a direction question here: the strokes follow a “flowing” pattern.

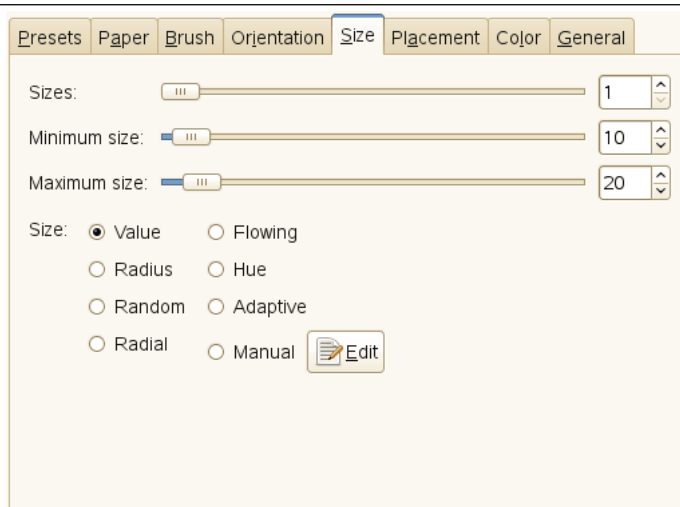
Hue Let the hue of the region determine the direction of the stroke.

Adaptive The brush direction that matches the original image the closest is selected.

Manual The Edit button opens the **Edit orientation Map dialog** that allows you to set the directions manually.

17.11.13.3.6 Size tab

Figure 17.222 “Size” tab options



This tab allows you to set the number of brush sizes that will be used to paint, the limits of variation of these sizes and the criterion used to determine them.

Size options

You can specify how many brush sizes are to be used and their sizes.

Sizes The number of brush sizes to use.

Minimum size, Maximum size The brush sizes are between these two values. The greater the size, the greater the length and width of strokes.

Size You have three options to specify how the size of strokes will be determined.

Value Let the value (luminosity) of the region determine the size of the stroke.

Radius The distance from the center of the image determines the size of the stroke.

Random Select a random size for each stroke.

Radial Let the direction from the center determine the size of the stroke.

Flowing Not a length question here: the strokes follow a “flowing” pattern.

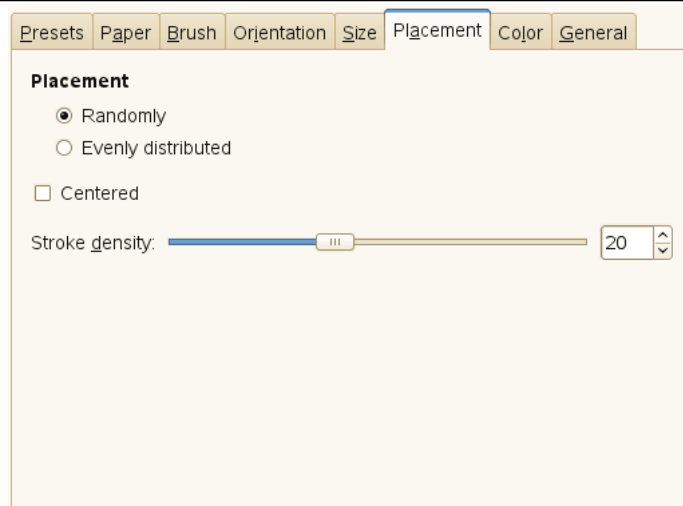
Hue Let the hue of the region determine the size of the stroke.

Adaptive The brush size that matches the original image the closest is selected.

Manual The Edit button opens the **Size Map Editor**. That allows you to specify the size of strokes by yourself.

17.11.13.3.7 Placement tab

Figure 17.223 “Placement” tab options



In this tab you can set how strokes will be distributed.

Placement options

Placement In the preview of the Orientation Map Editor, all small arrows look like a flow around objects. Inside this flow, strokes may be placed in two different ways:

Randomly Places strokes randomly. This produces a more realistic paint.

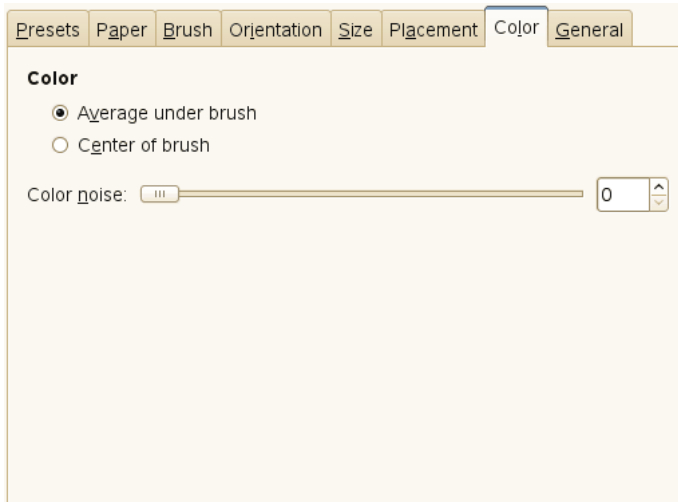
Evenly distributed Strokes are evenly distributed across the image.

Stroke density The greater the density the closer the strokes. With a low density, the paper or background may be visible in unstroke areas.

Centered Focus brush strokes around center.

17.11.13.3.8 Color tab

Figure 17.224 “Color” tab options



In this tab, you can set what the stroke color will be.
Color options

Color You can set the stroke color in two ways:

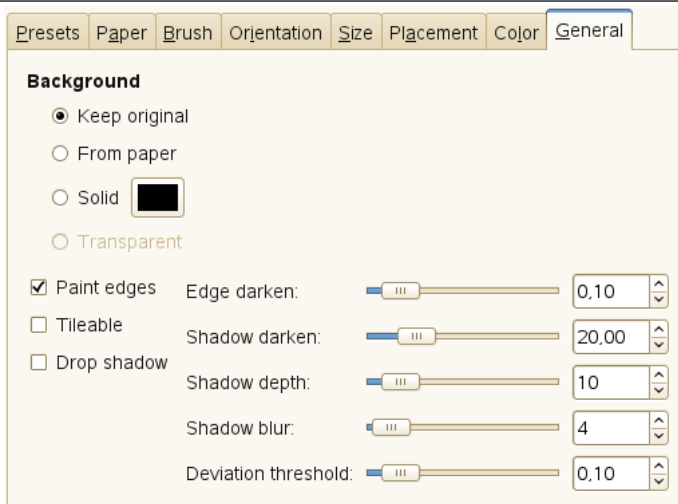
Average under brush Stroke color is computed from the average of all pixels under the brush.

Center of brush Samples the color from the pixel in the center of the brush.

Color noise This slider, and its input box, allow you to introduce noise in the stroke color, that will look less homogeneous.

17.11.13.3.9 General tab

Figure 17.225 “General” tab options



In this tab you can set what will be the background and the relief of brush strokes.
General options

Background

Keep original The original image will be used as a background.

From paper Copy the texture of the selected paper as a background.

Solid By clicking on the color dwell you can select a solid colored background.

Transparent Use a transparent background. Only the painted strokes will be visible. This option is available only if your image has an alpha channel.

Paint edges If it is disabled, a thin border will not be painted around the outside border of the image.

Tileable If checked, the resulting image will be seamlessly tileable. The right side will match the left side and the top will match the bottom. This is interesting if your image will be repeatedly used in a Web background.

Drop shadow Add a shadow effect to each brush stroke.

Edge darken How much to darken the edges of each brush stroke. This increases paint relief or thickness.

Shadow darken How much to darken the brush shadow.

Shadow depth How far apart from the object the drop shadow should be.

Shadow blur How much to blur the drop shadow.

Deviation threshold A bail-out value for adaptive selections of brush size.

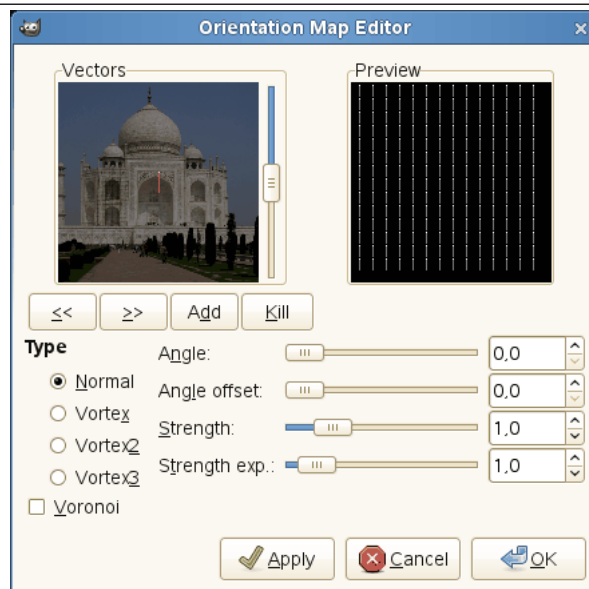
17.11.13.4 Orientation Map Editor

17.11.13.4.1 Overview

The Orientation-map editor is an annexe of the **GIMPpressionist** filter. You can get to it by clicking on the Edit button in the **Orientation** tab. With this editor, you can set the direction that brush strokes given by filter will have.

17.11.13.4.2 Options

Figure 17.226 Options of the “Orientation-map Editor” dialog



You can place one or several vectors. You can set their direction and their strength. They will act on the corresponding area of the image.

Vectors In the left windows (Vectors) you can manage your vectors. By default, a vector is at center. Vectors are red when they are active, and grey when they are not with a white point at tip.

- By clicking on the Add button, you add a vector at center of the window, whereas clicking with the mouse Middle Button puts it where you click.

- Clicking with the mouse Left Button displaces the selected vector to the clicked point.
- When clicking with the mouse Right Button, the selected vector points to where you have clicked.
- Clicking on << and >> buttons displaces focus from a vector to another.
- The Delete button allows you to delete the selected vector.

Tip

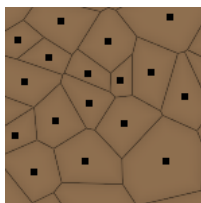


With the scroll bar on the right of the Vectors panel, you can set the image brightness. This can be very useful if the image is very dark/bright and you can't see vectors well.

Preview This Preview gives you an idea of the action of the various vectors. The slider on the right border lets you change the luminosity of this preview.

Type You have there some types to arrange the brush strokes within the selected vector domain. Describing them is difficult, but you can see the result in the Preview.

Voronoi A Voronoi's diagram consists in partitioning a plane with n master points into n polygons where each polygon has only one of these n master points and where any given other point of the polygon is closer to the master point than to any other. So each polygon limit is midway between two master point. Here is an example of a Voronoi's diagram:



Here, when this option is checked, only the vector closest to a given point of the image influences this point.

Angle Direction of the selected vector. This slider has the same action as right-clicking (see above).

Angle offset This slider allows you to change the angle of *all* vectors.

Strength This slider acts on the influence domain of the selected vector. This influence lowers with distance. Strength is showed with the vector length.

Strength exp. This slider acts on the length of *all* vectors, and so changes the strength of all brush strokes.

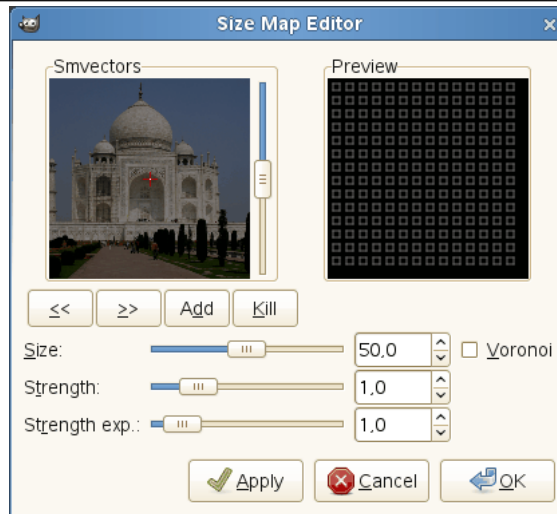
17.11.13.5 Size Map Editor

17.11.13.5.1 Overview

The Size-map editor is an annexe of the **GIMPressionist** filter. You can get to it by clicking on the Edit button in the **Size** tab. With this editor, you can set the size that brush strokes given by filter will have.

17.11.13.5.2 Options

Figure 17.227 Size-map editor options



You can place one or several vectors. You can set their strength. They will act on the corresponding area of the image.

Smvectors In this window you can place your vectors. By clicking on the Add button, you add a vector at the center of the window, whereas clicking with the mouse Middle Button puts it where you click. Vectors are red when selected, and gray when they are not, with a white point at tip.

Clicking with the mouse Left Button displaces the selected vector to the clicked point.

Clicking on the mouse Right Button, has no evident action.

Clicking on << and >> buttons displaces focus from a vector to another.

The Kill button allows you to delete the selected vector.

Tip



With the scroll bar on the right of the Vectors panel, you can set the image brightness. This can be very useful if the image is very dark/bright and you can't see vectors well.

Preview This Preview gives you an idea of the action of the different vectors. The size of squares represent the size of the brushes and their strength.

Size Change the size of the brush strokes in the selected vector domain.

Strength This slider acts on the influence domain of the selected vector. This influence lowers with distance.

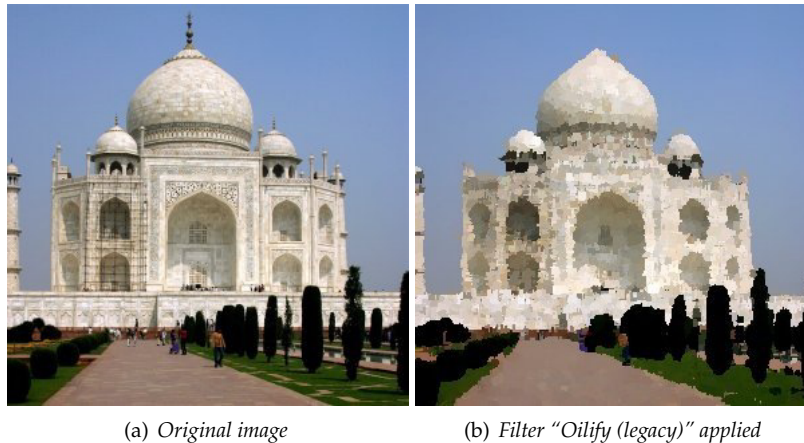
Strength exp. Change the exponent of the stroke.

Voronoi See [Orientation Map Editor](#) for an explanation.

17.11.14 Oilify (legacy)

17.11.14.1 Overview

Figure 17.228 Example for the “Oilify (legacy)” filter



This filter makes the image look like an oil painting. The Mask size controls the outcome: a high value gives the image less detail, as if you had used a larger brush.

Tip



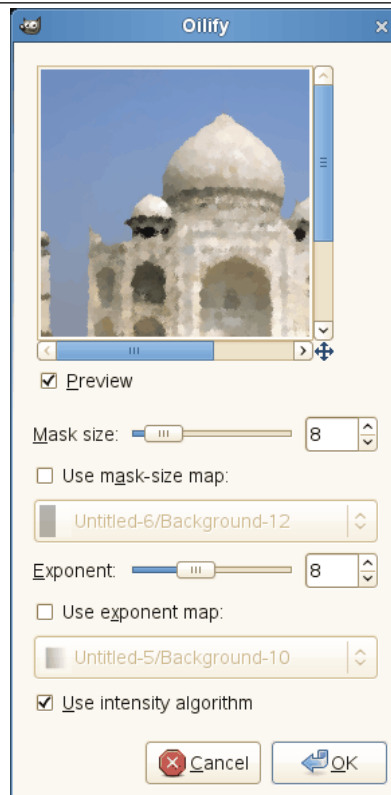
The GIMPpressionist filter can produce similar effects, but allows a much wider variety of options.

17.11.14.2 Activate the filter

This filter is found in the image menu through Filters → Artistic → Oilify (legacy)....

17.11.14.3 Options

Figure 17.229 “Oilify (legacy)” filter options



Mask size Mask size selects the size of the brush mask used to paint the oily render. Larger values here produce an oilier render.

Use mask-size map You may use a mask-size map to control Mask size partially. Mask size is reduced according to darkness in each pixel of the map image. You can select a map image among the current opened images of the same size as the source image.

Exponent Exponent selects density of the brush mask used to paint the oily render.

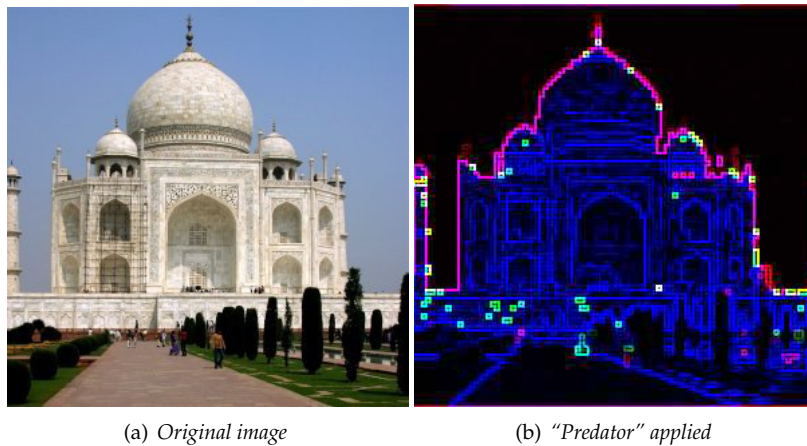
Use exponent map You may use an exponent map to control density of brush touch partially. Density is reduced according to darkness in each pixel of the map image. You can select a map image among the current opened images of the same size as the source image.

Use intensity algorithm “Use intensity algorithm” changes the mode of operation to help preserve detail and coloring.

17.11.15 Predator

17.11.15.1 Overview

Figure 17.230 Example for the “Predator” filter



This filter adds a “Predator” effect to the image. The predator effect makes the image/selection look something like the view the predator has in movies (kind of a thermogram and that type of thing). This will reduce the image to edges in a few basic colors on a dark background.

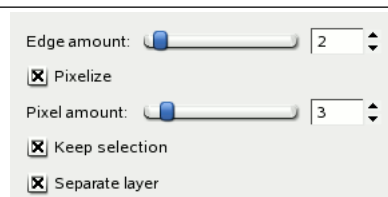
If there is an active selection, the filter effect will be applied to the selected region, otherwise to the alpha channel (the filter will add an alpha channel, if necessary). The filter works best on colorful RGB images.

17.11.15.2 Activate the filter

This filter is found in the image window menu under Filters → Artistic → Predator....

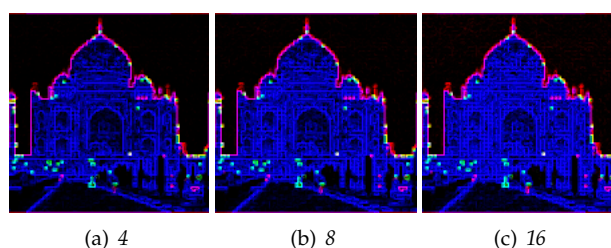
17.11.15.3 Options

Figure 17.231 “Predator” options



Edge amount The “predator” filter will detect edges using the Sobel [edge detector](#). The specified “Edge amount” will be passed to the Sobel filter. A high value will result in detecting more edges.

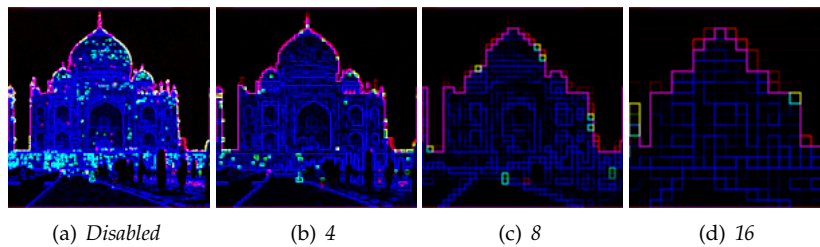
Figure 17.232 “Edge amount” examples



Pixelize If checked, the filter will simplify the image into solid-colored squares using the **Pixelize** filter before the real predator effect will be applied. You can select the size of these squares with the option Pixel amount, which will heavily affect the result (see examples below).

Pixel amount “Pixel amount” is the size of the color blocks the image will be simplified to if Pixelize is checked. Actually you are decreasing the resolution with this option. In the examples below, you can see directly how increasing the pixel block size leads to something like “macro pixels”:

Figure 17.233 “Pixelize” examples



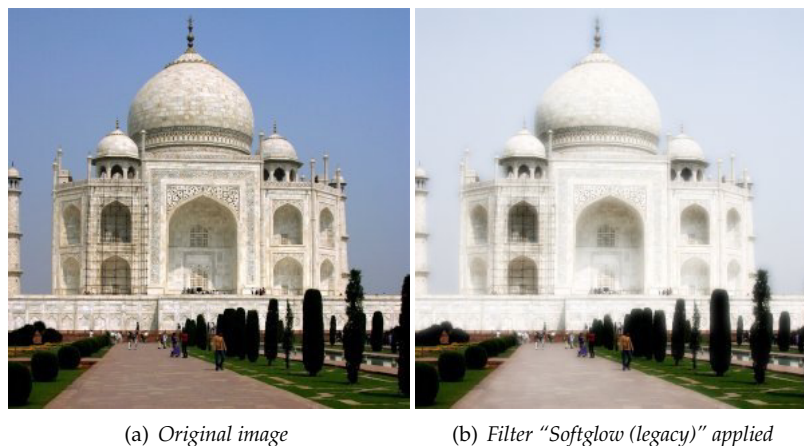
Keep selection If checked, the filter will be applied to the active selection. Else, it will be applied to the active layer.

Separate layer When this option is checked, a copy of the active layer will be created above the active layer and the filter will be applied to this copy, leaving the original layer untouched. If not checked, the filter will be applied to the active layer.

17.11.16 Softglow (legacy)

17.11.16.1 Overview

Figure 17.234 Example for the “SoftGlow (legacy)” filter



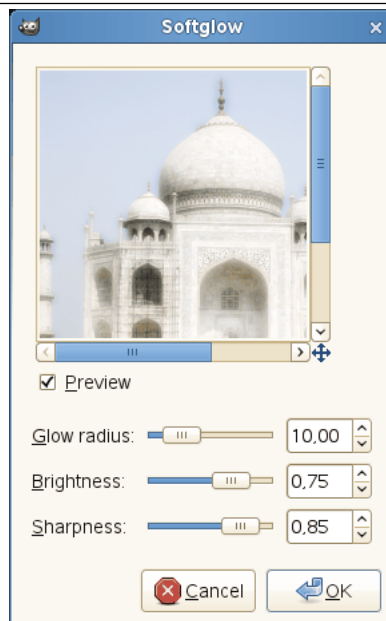
This filter lights the image with a soft glow, like the old trick smearing vaseline on the lens. Softglow (legacy) produces this effect by making bright areas of the image brighter.

17.11.16.2 Starting filter

You can find this file in the Image menu through: Filters → Artistic → Softglow....

17.11.16.3 Options

Figure 17.235 “Softglow” filter options



Preview Your changes are displayed in this preview before being applied to your image.

Glow radius The glow radius parameter controls the sharpness of the effect, giving a “vaseline-on-the-lens” effect.

Brightness The brightness parameter controls the degree of intensification applied to image highlights.

Sharpness The sharpness parameter controls how defined or alternatively diffuse the glow effect should be.

17.11.17 Van Gogh (LIC)

17.11.17.1 Overview

Figure 17.236 From left to right: original image, map, resulting image



Map has three stripes: a solid black area, a vertical gradient area, a solid white area. One can see, on the resulting image, that image zones corresponding to solid areas of the map, are not blurred. Only the image zone corresponding to the gradient area of the map is blurred.

“LIC” stands for Line Integral Convolution, a mathematical method. The plug-in author uses mathematical terms to name his options... This filter is used to apply a directional blur to an image, or to create textures. It could be called “Astigmatism” as it blurs certain directions in the image.

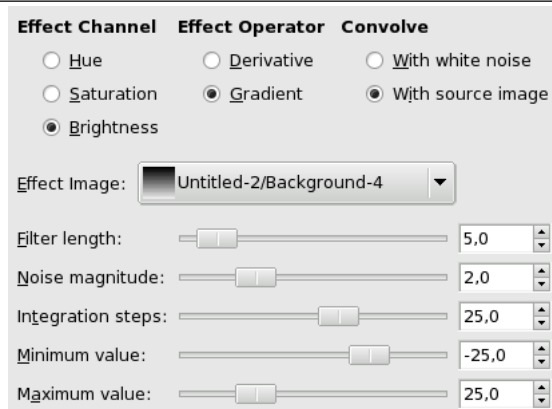
It uses a blur map. Unlike other maps, this filter doesn’t use grey levels of this blur map. *Filter takes in account only gradient direction(s)*. Image pixels corresponding to solid areas of the map are ignored.

17.11.17.2 Activate the filter

You can find this filter through Filters → Artistic → Van Gogh (LIC)....

17.11.17.3 Options

Figure 17.237 “Van Gogh (LIC)” filter options



Tip

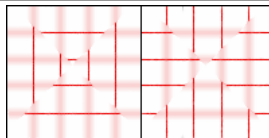


- To create a blur, check With Source Image. Only Filter Length slider and perhaps Integration Steps slider, are useful.
- To create a texture, check With White Noise. All sliders can be useful.

Effect Channel By selecting Hue, Saturation or Brightness (=Value), filter will use this channel to treat image.

Effect Operator The “Derivative” option reverses “Gradient” direction:

Figure 17.238 Derivative option example



Using a square gradient map, Effect operator is on “Gradient” on the left, on “Derivative” on the right: what was sharp is blurred and conversely.

Convolve You can use two types of convolution. That’s the first parameter you have to set:

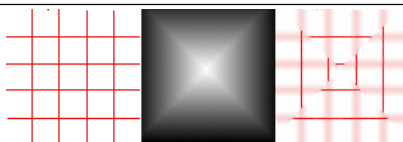
With white noise White noise is an acoustics name. It’s a noise where all frequencies have the same amplitude. Here, this option is used to create patterns.

With source image The source image will be blurred.

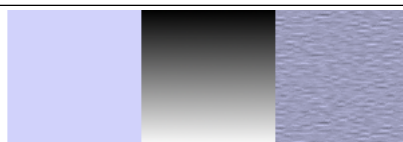
Effect image That’s the map for blur or pattern direction. This map must have the same dimensions as the original image. It must be preferably a grayscale image. It must be present on your screen when you call filter so that you can choose it in the drop-list.

Figure 17.239 Blurring with vertical gradient map

With a vertical gradient map, vertical lines are blurred.

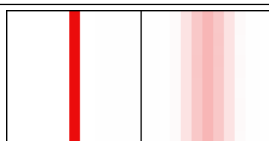
Figure 17.240 Blurring with a square gradient map

The gradient map is divided into four gradient triangles: each of them has its own gradient direction. In every area of the image corresponding to gradient triangles, only lines with the same direction as gradient are blurred.

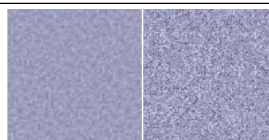
Figure 17.241 Texture example

The "With white noise" option is checked. Others are default. With a vertical gradient map, texture "fibres" are going horizontally.

Filter length When applying blur, this option controls how important blur is. When creating a texture, it controls how rough texture is: low values result in smooth surface; high values in rough surface.

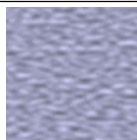
Figure 17.242 Action example of Filter Length on blur

On the left: a vertical line, one pixel wide (zoom 800%). On the right: the same line, after applying a vertical blur with a Filter Length to 3. You can see that blur width is 6 pixels, 3 pixels on both sides.

Figure 17.243 Filter Length example on texture

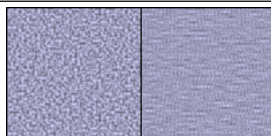
On the left: a texture with Filter Length=3. On the right, the same texture with Filter Length=24.

Noise magnitude This options controls the amount and size of White Noise. Low values produce finely grained surfaces. High values produce coarse-grained textures.

Figure 17.244 Action example of Noise Magnitude on texture

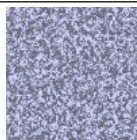
Noise magnitude = 4

Integration steps This options controls the influence of gradient map on texture.

Figure 17.245 Action example of Integration Steps on texture

On the left: Integration Steps = 2. On the right: Integration Steps = 4.

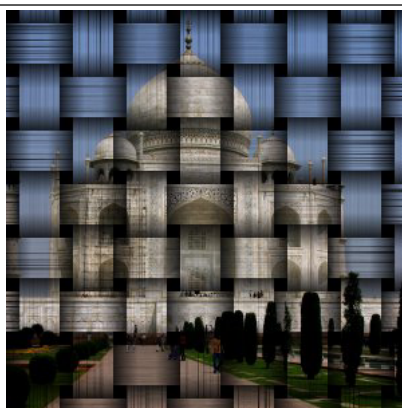
Minimum value, Maximum value Both values determine a range controlling texture contrast: shrunk range results in high contrast and enlarged range results in low contrast.

Figure 17.246 Action example of min/max values on texture

Minimum value = -4.0. Maximum value = 5.0.

17.11.18 Weave

17.11.18.1 Overview

Figure 17.247 Example of Weave

Filter "Weave" applied

The Weave command is a Script-Fu script which creates a new layer filled with a weave effect and adds it to the image as an overlay or bump map. The result of the image looks as if it were printed over woven ribbons of paper, thin wooden sheet, or stripped bamboo.

If the image is in indexed colors, this menu entry is grayed out and unavailable.

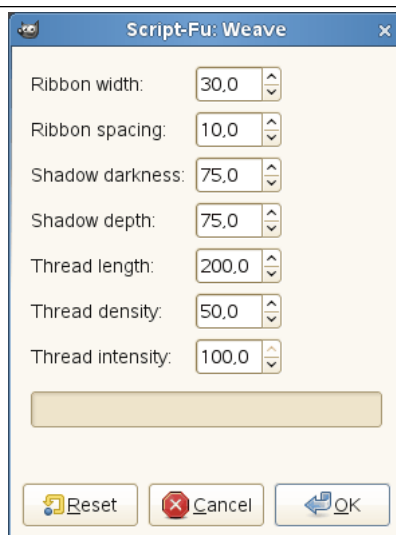
This filter adds a "Multiply" mode layer upon the layer where you activate this command. The weave texture is rendered in gray levels.

17.11.18.2 Activate the filter

This filter is found in the image window menu under Filters → Artistic → Weave...

17.11.18.3 Options

Figure 17.248 “Weave” filter options



For to make coarse mesh texture, increase the ribbon spacing and/or decrease the ribbon width.

For to strain ribbons hard, decrease the shadow depth.

Ribbon width With this option you can set the tape width in pixel between 0.0 and 256.0. In default, 30.0 pixels is set.

Ribbon spacing With this option you can set the distance to the neighboring ribbon or the size of black square hole in pixel between 0.0 and 256.0. In default, 10.0 pixels is set.

Shadow darkness With this option you can set the darkness at crossings of lower ribbon in percentage. Lower value shows ribbons thinner. 75.0 percent is the default value.

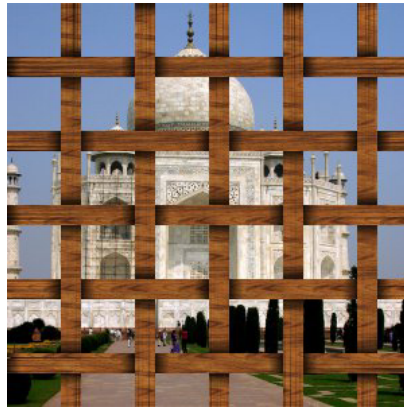
Shadow depth With this option you can set the bent strength of ribbons in percentage. Higher value shows ribbons more wavy, lower value for flat surface. The actual effect is limited by the Shadow darkness. 75.0 percent is the default value.

Thread length With this option you can set the regularity of stripe texture. If this value is shorter than the summary of the ribbon width and twice of the ribbon spacing, the surface of ribbon becomes speckled. Set this value in pixel on range between 0.0 to 256.0. The default value is 200.0.

Thread density With this option you can set the density of fiber-like parallel short stripes on the surface of ribbons. To populate stripes increase this value. 50.0 percent is the default value.

Thread intensity With this option you can set the opacity of stripe texture. Lower value shows threads vague. To clear off threads set the value to 0.0 percent. The default value is 100.0 percent.

17.11.18.4 Another usage

Figure 17.249 Adding a lattice using “Weave” texture

Narrower the ribbon width, wider the ribbon spacing, and filled with the “Wood #1” pattern.

This texture can be a lattice that you can see the original image through its mesh holes. Add a new, transparent layer over the active layer for the lattice, and apply this filter. Select a black regular square in the texture layer using the **Select By Color** tool, then delete black squares in selection on the texture layer to be chink holes. Reverse the selection, and activate the transparent layer so that you can fill the lattice surface with a pattern, then drag and drop your favorite pattern over the image window.

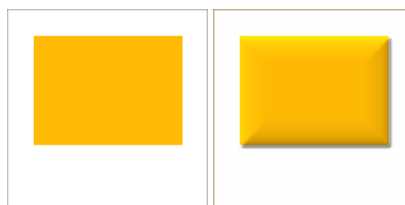
17.12 Decor Filters

17.12.1 Introduction

These filters are image-dependent Script-Fu scripts. They create decorative borders, and some of them add some nice special effects to the image.

17.12.2 Add Bevel

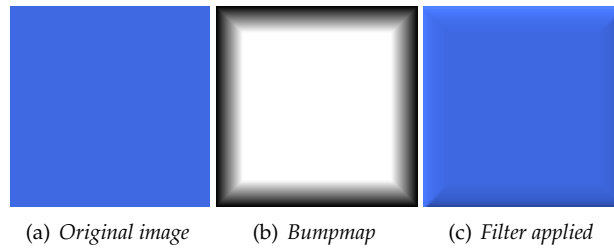
17.12.2.1 Overview

Figure 17.250 Example for the “Add Bevel” filter

(a) Original image, the (b) “Add Bevel” ap- colored rectangle is se- plied lected

This filter adds a slight bevel to an image using a **bump map** (see below). If there is a selection, it is bevelled, otherwise the filter has no effect.

Figure 17.251 Another “Add Bevel” example, with bumpmap

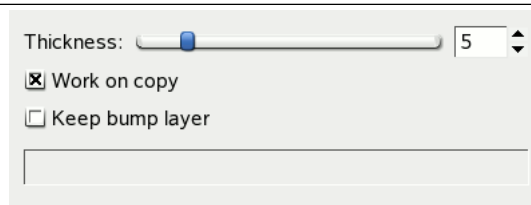


17.12.2.2 Activate the filter

You can find this filter in the image window menu under **Filters** → **Decor** → **Add Bevel...**

17.12.2.3 Options

Figure 17.252 “Add Bevel” options



Thickness You can specify the thickness of the bevel, in pixels. Maximal thickness is 30 pixels.

Work on copy If checked, the filter creates a new window containing a copy of the image with the filter applied. The original image remains unchanged.

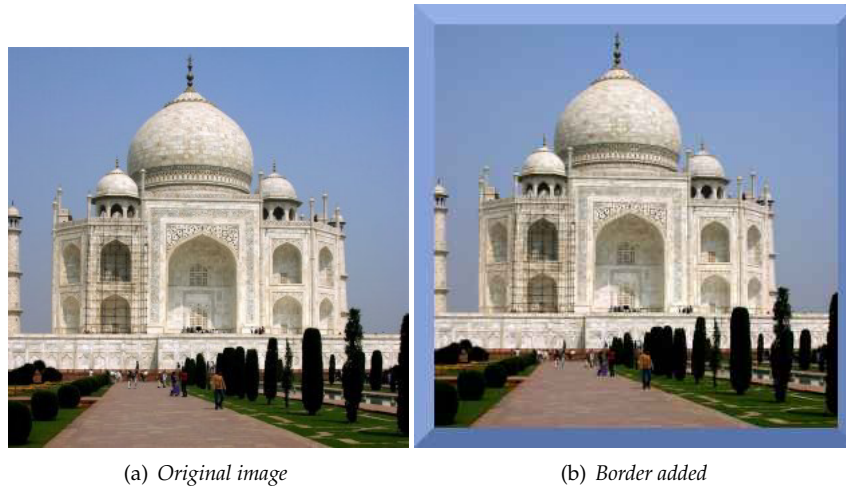
Keep bump layer When checked, you will keep the generated bumpmap as a new, not visible layer (below the layer dialog):



17.12.3 Add Border

17.12.3.1 Overview

Figure 17.253 Example for the “Add Border” filter



This filter just does what its name says: it adds a border to the image. You can specify the thickness of the border as well as the color. The four sides of the border are colored in different shades, so the image area will appear raised.

The image will be enlarged by the border size, it won't be painted over.

17.12.3.2 Activate the filter

This filter is found in the image window menu under Filters → Decor → Add Border....

17.12.3.3 Options

Figure 17.254 “Add Border” options

Border X size:	12	⬆ ⬇ ⬆
Border Y size:	12	⬆ ⬇ ⬆
Border color:	<div style="background-color: blue; width: 20px; height: 10px; margin: 0 auto;"></div>	
Delta value on color:	25	⬆ ⬇ ⬆

Border X size, Border Y size Here you can select the thickness of the added border, in pixels. X size (left and right) and Y size (top and bottom) may be different. Maximum is 250 pixels.

Border color Clicking on this button brings up the color selector dialog that allows you to choose an “average” border color (see below, Delta value on color).

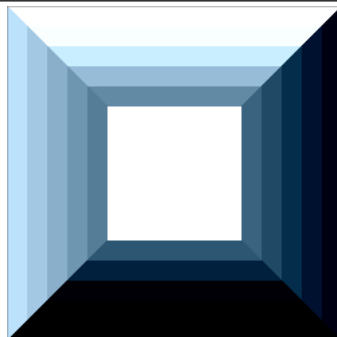
Delta value on color This option makes the border sides to be colored in different shades and thus makes the image to appear raised. The actual color of the respective border side is computed for every color component red, green, and blue³ from the “average” Border color as follows (resulting values less than 0 are set to 0, values greater than 255 are set to 255):

- Top shade = Border color + Delta
- Right shade = Border color - ½ Delta

³See [image types](#) or [RGB](#).

- Bottom shade = Border color - Delta
- Left shade = Border color + $\frac{1}{2}$ Delta

Figure 17.255 Delta examples



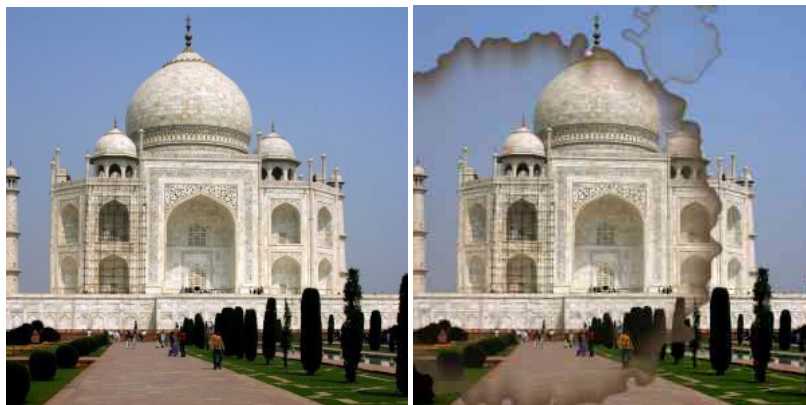
“Add Border” filter applied with Delta value 25, then with 75, 125, 175, and 225.

Example: the default color is blue (38,31,207), default delta is 25. So the shades of the borders are: top: (38,31,207) + (25,25,25) = (63,56,232), right: (38,31,207) + (-13,-13,-13) = (25,18,194), etc.

17.12.4 Coffee Stain

17.12.4.1 Overview

Figure 17.256 Example for the “Coffee Stain” filter



(a) *Original image*

(b) *“Coffee Stain” applied*

This filter adds realistic looking coffee stains to the image.

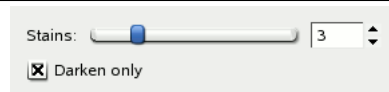
Every stain is created in a layer of its own. The stain layers are randomly moved to let the stains spread out (at the end you may see the boundary of the moved top layer). So after applying the filter you can easily edit (e.g., move, scale, remove) the coffee stains, or create additional stains using the filter again.

17.12.4.2 Activate the filter

The filter is found in the image window menu under Filters → Decor → Coffee Stain....

17.12.4.3 Options

Figure 17.257 “Coffee Stain” options



Stains The number of the coffee stains (1-10).

Darken only Since every stain is created in a layer of its own, all layers have to be merged to make the appearance of the image. If this option is checked, the relevant **layer mode** is set to “Darken only”, otherwise it is set to “Normal”.

The layer mode determines how the pixels of the layers are combined. In “Normal” mode, every coffee stain covers the pixels of the layers below. As a rule of thumb, if layer mode “Darken only” is set, coffee stains covers the corresponding pixels of the layers below them only if these pixels are lighter.

17.12.5 Fog

17.12.5.1 Overview

Figure 17.258 Example for the “Fog” filter



(a) Original image

(b) “Fog” applied

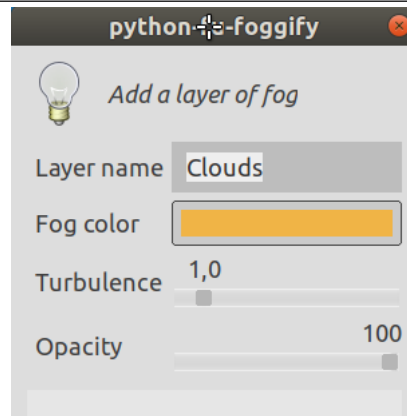
This filter adds a new layer with some clouds to the image that look like fog or smoke. The clouds are created with the **Plasma** texture.

17.12.5.2 Activating the filter

This filter is found in the image window menu under Filters → Decor → Fog....

17.12.5.3 Options

Figure 17.259 “Fog” options



Among the few filter options, only “Turbulence” is somewhat important, because you can’t change it later and have to undo and repeat the filter if the result doesn’t fit your desire.

Layer name The name of the layer. You can change it later in the [Layers Dialog](#).

Fog color Defaults to some kind of sandy brown (240, 180, 70). Click on the color button to change this if you think that is not the natural color of fog.

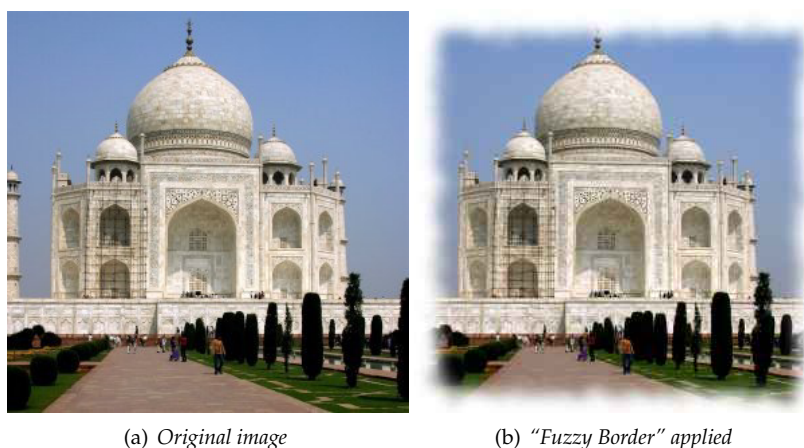
Turbulence This is actually the Turbulence option of the [Plasma](#) filter: it controls the complexity of the clouds, from soft (low values) to hard (high values).

Opacity The opacity of the layer. You can change it later in the [Layers Dialog](#).

17.12.6 Fuzzy Border

17.12.6.1 Overview

Figure 17.260 Example for the “Fuzzy Border” filter



(a) Original image

(b) “Fuzzy Border” applied

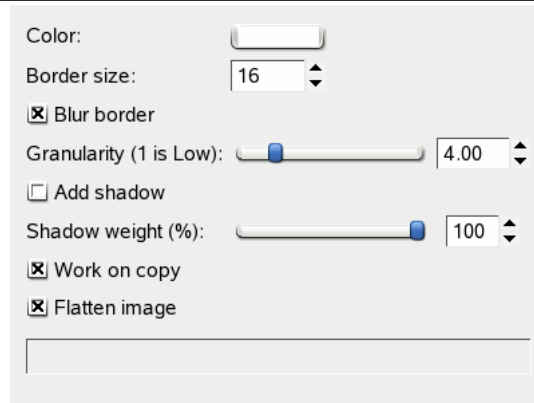
This filter adds a cool fading border to an image. The border will look jagged and fuzzy, and you can specify color and thickness of the fading border. Optionally you may add a shadow to the image.

17.12.6.2 Activate the filter

You can find this filter in the image window menu through Filters → Decor → Fuzzy Border....

17.12.6.3 Options

Figure 17.261 “Fuzzy Border” options

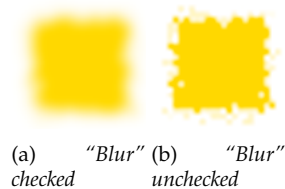


Color Clicking on this button brings up the color selector dialog that allows you to choose the border color.

Border size Here you can set the thickness of the fuzzy border, in pixels. Maximum is 300 pixels, regardless of the image width or height.

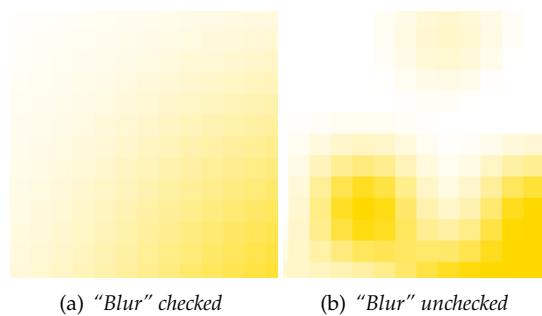
Blur border If checked, the border will be blurred. The example below shows the effect of blurring:

Figure 17.262 “Blur border” example



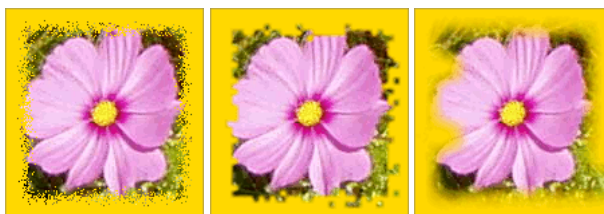
(a) “Blur” checked (b) “Blur” unchecked

Figure 17.263 “Blur border” zoomed (1600%)



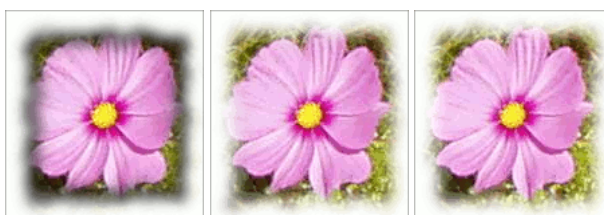
(a) “Blur” checked (b) “Blur” unchecked

Granularity The border’s granularity is almost the size of pixel blocks spread to create the effect of a jagged and fuzzy border.

Figure 17.264 Granularity example (without blurring)

(a) Granularity 1 (min) (b) Granularity 4 (default) (c) Granularity 16 (max)

Add shadow If checked, the filter will also create a shadow at the border.

Figure 17.265 “Add shadow” example

(a) “Add shadow” unchecked (default shadow weight).
 (b) “Add shadow” checked, shadow weight 100% (default shadow weight).
 (c) “Add shadow” checked, shadow weight unchecked (default shadow weight).

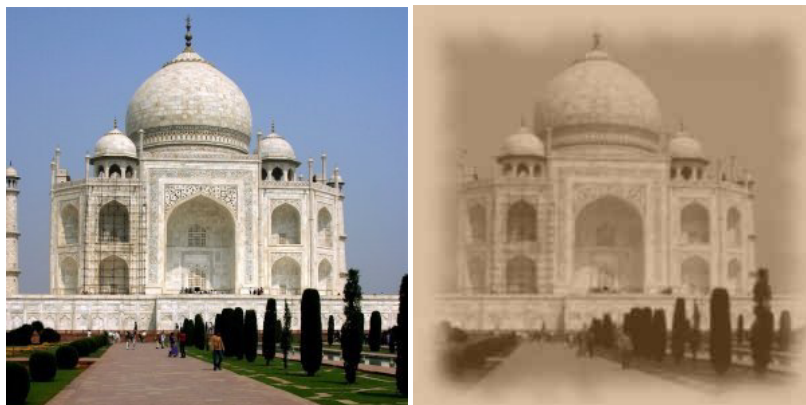
Shadow weight If Add shadow is checked, you may set the shadow opacity here. Defaults to 100% (full opacity).

Work on copy If checked, the filter creates a new window containing a copy of the image with the filter applied. The original image remains unchanged.

Flatten image If unchecked, the filter keeps the additional layers it used to create the border and the shadow (if demanded). Default is to merge down all layers.

17.12.7 Old Photo

17.12.7.1 Overview

Figure 17.266 Example for the “Old Photo” filter

(a) Original image

(b) “Old Photo” applied

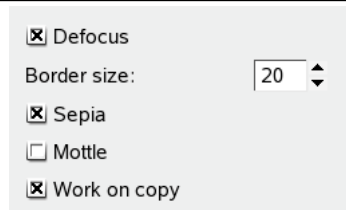
This filter makes an image look like an old photo: blurred, with a jagged border, toned with a brown shade, and marked with spots.

17.12.7.2 Activate the filter

The filter is found in the image window menu under Filters → Decor → Old Photo....

17.12.7.3 Options

Figure 17.267 “Old Photo” options



Defocus If checked, a **Gaussian blur** will be applied to the image, making it less clear.

Figure 17.268 Example for the “Defocus” option



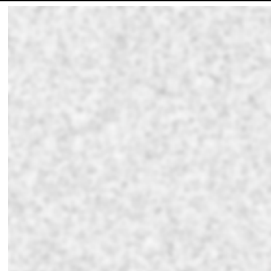
(a) *Defocus enabled* (b) *Defocus disabled*

Border size When you choose a border size > 0 , the **Fuzzy Border** filter will be applied to the image, adding a white, jagged border.

Sepia If checked, the filter reproduces the effect of aging in old, traditional black-and-white photographs, toned with sepia (shades of brown).⁴ To achieve this effect, the filter desaturates the image, reduces brightness and contrast, and modifies the color balance.⁵

Mottle When you check this option, the image will be marked with spots.

Figure 17.269 Example for the “Mottle” option



A plain white image mottled (without Defocus or Sepia)

⁴See Wikipedia [[WKPD-SEPIA](#)].

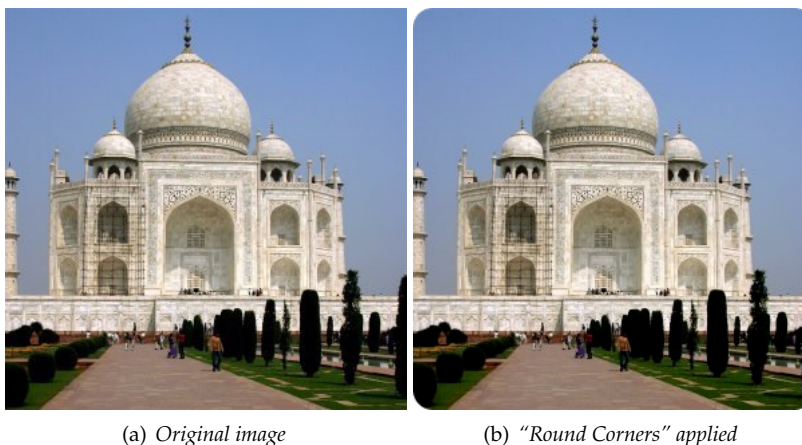
⁵Compare Section [16.8.2](#).

Work on copy If checked, the filter creates a new window containing a copy of the image with the filter applied. The original image remains unchanged.

17.12.8 Round Corners

17.12.8.1 Overview

Figure 17.270 Example for the “Round Corners” filter



This filter rounds the corners of an image, optionally adding a drop-shadow and a background layer.

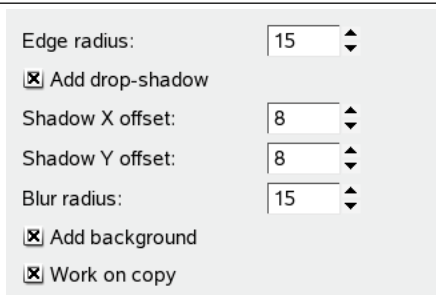
The filter works on RGB and grayscale images that contain only one layer. It creates a copy of the image or can optionally work on the original. It uses the current background color to create a background layer.

17.12.8.2 Activate the filter

This filter is found in the image window menu under Filters → Decor → Round Corners....

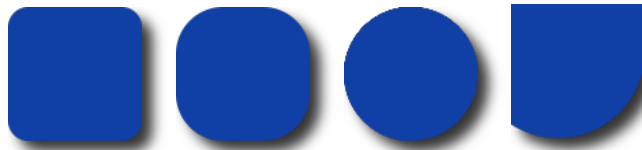
17.12.8.3 Options

Figure 17.271 “Round Corners” options



Edge radius Rounding corners is done by selecting a quarter of a circle at every corner and removing the area not covered by this selection. The “edge radius” is the radius of the constructing circle.

In the examples below, the filter was applied to a 100x100 pixels image, with varying edge radius. For radius = 50, the four quadrants just form a circle with diameter = 100, which exactly fits into the original image outline. A radius greater than 50 is possible, but look what happens...

Figure 17.272 Edge radius examples

(a) A 100x100 pixels image, edge radius: 15 (default).
 (b) Edge radius: 35.
 (c) Edge radius: 50.
 (d) Edge radius: 65. Ouch!

Add drop-shadow When this option is checked, the filter will cast a shadow behind your image after rounding the image corners.

Shadow X/Y offset X and Y offset determine where the shadow will be placed in relation to the image. Offset is measured in pixels. High values make the shadow look like it's far away, and low values will make it look closer to the image.

Figure 17.273 Shadow offset examples

(a) Shadow X offset: 8, Y offset: 8 (default).
 (b) Shadow X offset: 16, Y offset: 4.

Note that the shadow offsets as well as the blur radius are limited to background area.

Blur radius When Add drop-shadow is checked, you may select a blur radius, which will be used by the **Drop Shadow** filter. The image will be enlarged in both dimensions depending on the blur radius and the shadow offsets.

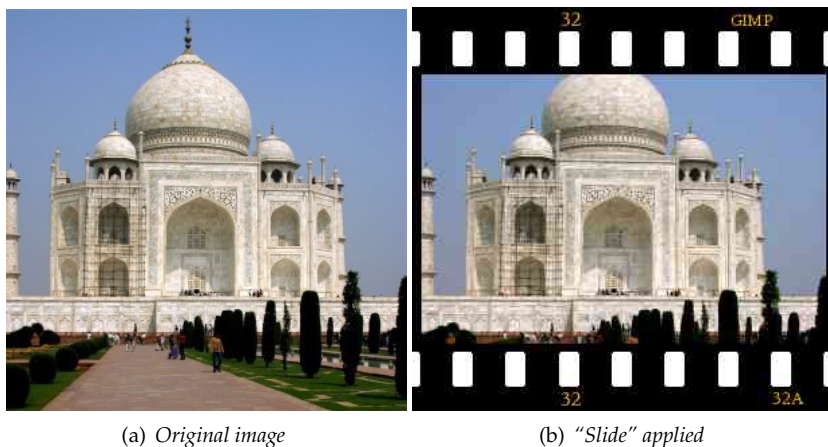
Add background When you check this option (it is checked by default), the filter will add a background layer below the existing layer, filled with the current background color. The size of this new layer depends on the blur radius and the shadow offsets.

Work on copy If checked, the filter creates a new window containing a copy of the image with the filter applied. The original image remains unchanged.

17.12.9 Slide

17.12.9.1 Overview

Figure 17.274 Example for the “Slide” filter



This filter makes your image look like a slide, by adding a slide-film like black frame, sprocket holes, and labels.

If necessary, the image will be cropped to fit into an aspect ratio of width : height = 3:2. If image width is greater than image height, black frames will be added at the top and the bottom of the image, else the frames will be added on the left and right sides. You may select the color as well as the font of the text appearing on the frames. The current background color will be used for drawing the holes.

The script only works on RGB and grayscale images that contain one layer. Otherwise the menu entry is insensitive and grayed out.

17.12.9.2 Activate the filter

The filter is found in the image window menu under Filters → Decor → Slide....

17.12.9.3 Options

Figure 17.275 “Slide” options



Text A short label that will be displayed in the top and bottom (or the left and right) of the frame. The text must be really short.

Number Here you may enter a text for simulating consecutive numbers. Two numbers will be displayed: this number and this number with the character “A” appended.

Font Clicking on this button opens the **Font dialog**, where you can choose a font for the text on the frame.

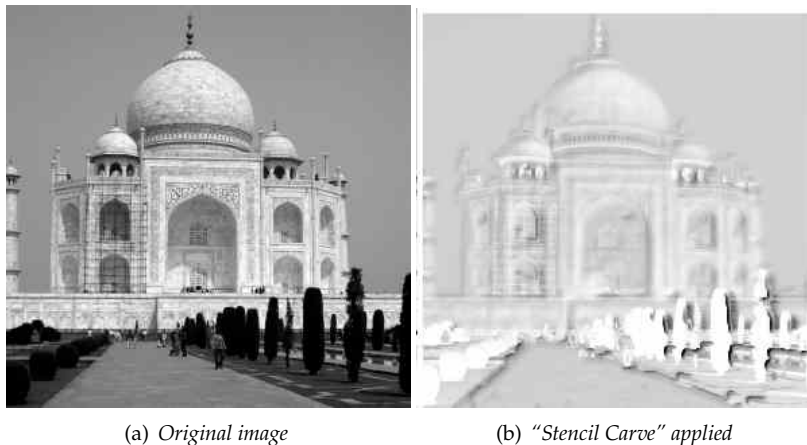
Fontcolor Clicking on this button brings up a color selection dialog that allows you to choose the color of the text.

Work on copy If checked, the filter creates a new window containing a copy of the image with the filter applied. The original image remains unchanged.

17.12.10 Stencil Carve

17.12.10.1 Overview

Figure 17.276 Example for the “Stencil Carve” filter



(a) Original image

(b) “Stencil Carve” applied

This filter works with two images, source and target. The source image must be a grayscale image containing a single layer and no Alpha channel. This layer is used as selection mask and will work as stencil for the carving effect. The image to be carved (the target image) can be an RGB color or grayscale image, also with a single layer. This target image must have the same size as the source image.

17.12.10.2 Activating the filter

This filter is found in the image window menu under Filters → Decor → Stencil Carve....

Tip



If this command remains grayed out although the image is grayscale, check for an Alpha channel and delete it.

17.12.10.3 Options

Figure 17.277 “Stencil Carve” options

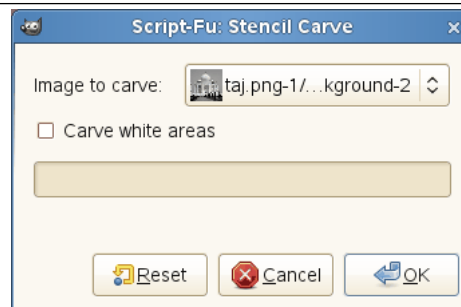
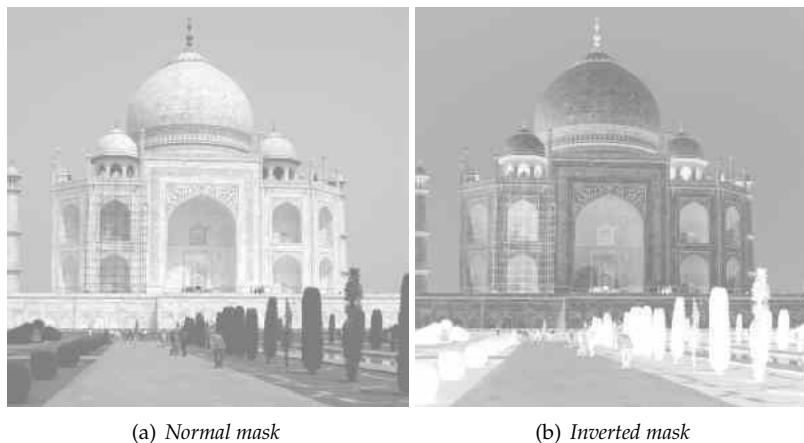


Image to carve Here you may select the target image, i.e. the image the carving effect is applied to. The drop-down list will show you a list of opened images which may be carved.

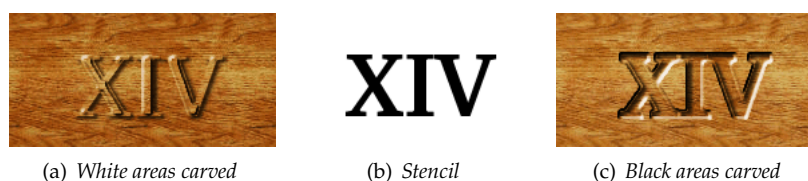
Carve white areas If checked (default), the source image is used as stencil as described above. If unchecked, the *inverted* source image is used as stencil, e.g.:

Figure 17.278 Engraving Masks



In the example below, the source is a grayscale image. The target is an image with a wood pattern. On the left, Carve white areas is enabled. The pixels of the target image corresponding to white pixels in the stencil (around the text) have been carved. The result is an embossed text. On the right, Carve white areas is disabled. The pixels of the target image corresponding to the black pixels in the stencil (the text) have been carved. The result is a hollow text.

Figure 17.279 Example for “Carve white areas”

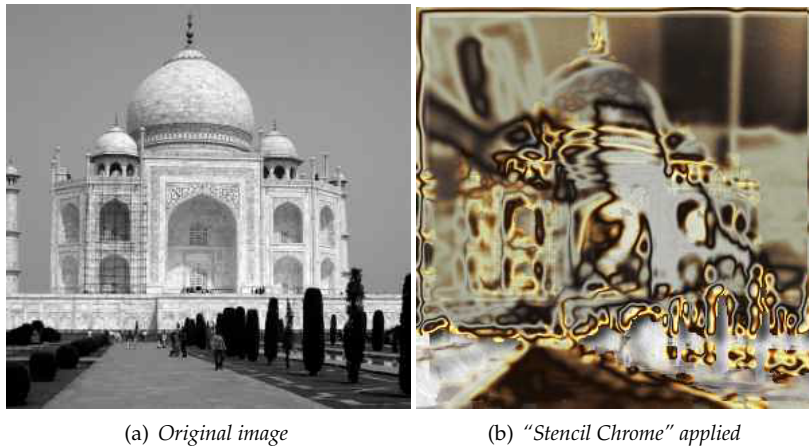


Information about the many layers created by this filter can be found in [[GROKING](#)].

17.12.11 Stencil Chrome

17.12.11.1 Overview

Figure 17.280 Example for the “Stencil Chrome” filter



This filter provides a state of the art chrome effect. The source image must be an image in grayscale mode, containing a single layer without alpha channel. This layer is used as mask (“stencil”) for the chrome effect.

The filter creates a new image with the chrome effect applied to the source image or, if a selection exists, to the selection of the source image (a nice background is added too).

17.12.11.2 Activating the filter

This filter is found in the image window menu under Filters → Decor → Stencil Chrome....

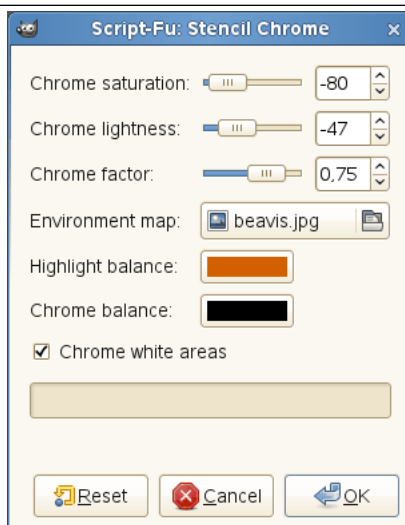
Tip



If this command remains grayed out although the image is in grayscale mode, check for an Alpha channel and delete it.

17.12.11.3 Options

Figure 17.281 “Stencil Chrome” options

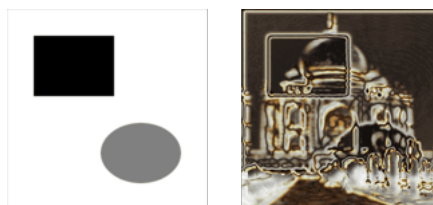


Chrome saturation, Chrome lightness Use this option to control how **saturation and lightness** of the “Chrome” layer are adjusted. Negative values decrease saturation and lightness respectively.

Chrome factor This factor lets you adjust offsets, feather radius, and brush size used to construct the “Chrome” and “Highlight” layer (and the “Drop Shadow” as well).

Change with caution, decreasing this value may make the chrome effect worse. The default factor 0.75 seems to be a good choice.

Environment map The environment map is an image that is added as some kind of “noise” to the source. The effect is best to see if you use a simple map with some obvious shapes:



Using a simple environment map

The environment map must be an image in grayscale mode too. Size doesn’t matter, the environment map is scaled to the size of the source image.

Highlight balance This color is used to modify the **color balance** of the “Highlight” layer: the amount of red, green, and blue colors is increased according to the corresponding values of the specified option.

Avoid colors with red, green or blue value > 230.

Chrome balance Same as above, but modifies the **color balance** of the “Chrome” layer.

Chrome white areas If checked (this is the default), the source image is used as mask. If unchecked, the *inverted* source image is used.

17.12.11.4 How to create the chrome effect

The following section provides a brief and simplified description of how the script (actually this filter is a Script-Fu) creates the chrome effect.

If you apply the filter to your source images and then look at the **layer dialog** of the resulting image, you will see that there are two main layers which make up the chrome effect: the “Chrome” layer and the “Highlight” layer. These layers are created as follows:

1. The script constructs a somewhat simplified and blurred layer from the source image (from the inverted source image if Chrome white areas is unchecked).



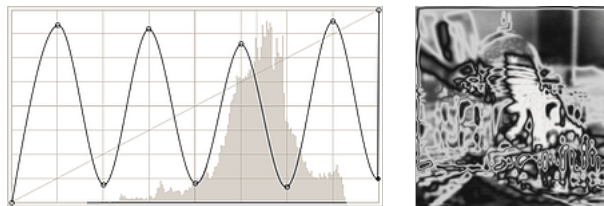
The Chrome factor controls the appearance of this layer.

2. The (scaled) environment map is blurred and merged into the above layer with 50% opacity. (Do you spot the cat in the introducing [example?](#))



Merging the environment map

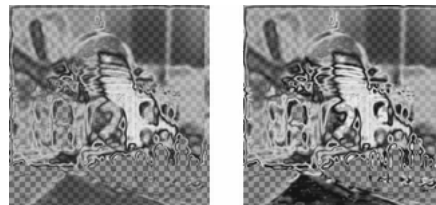
3. The brightness (value) of the layer is modified according to a spline-based intensity curve.



Modifying the intensity curve

4. A layer mask is added, initialized with the source image (the “Chrome Stencil”). This is the “Chrome” layer before the final step.

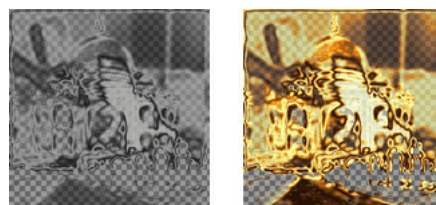
The “Highlight” layer is a copy of the “Chrome” layer where the layer mask is stroked with a white brush.



Chrome and Highlight base

5. For both layers the color balance is modified (according to Highlight balance and Chrome balance), increasing the amount of red, green, and blue, with emphasis on highlights.

Additionally, saturation and lightness of the “Chrome” layer are modified (controlled by Chrome saturation and Chrome lightness).



Chrome and Highlight layer

Now add a drop shadow and a background layer and you get the [Example image](#) for the “Stencil Chrome” filter.

17.13 Map Filters

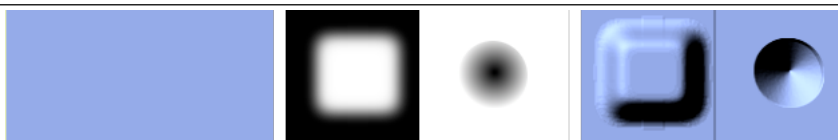
17.13.1 Introduction

Map filters use an object named *map* to modify an image: you map the image to the object. So, you can create 3D effects by mapping your image to another previously embossed image (“Bumpmap” Filter) or to a sphere (“Map Object” filter). You can also map a part of the image elsewhere into the same image (“Illusion” and “Tile Seamless” filters), bend a text along a curve (“Displace” filter)...

17.13.2 Bump Map

17.13.2.1 Overview

Figure 17.282 “bump-map” example



On the left, the original image that we want to emboss: a solid blue. In the middle, the bump map : a grayscale image, where black pixels will emboss backwards and white pixels will emboss forwards. On the right, the bump-mapped image. The filter adds a shadow effect.

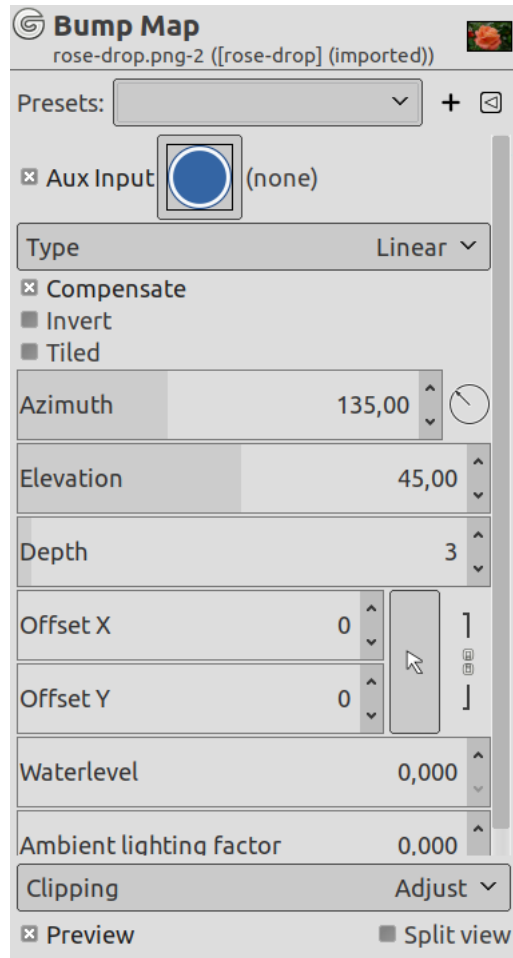
This filter creates a 3D effect by embossing an image (the card) and then mapping it to another image. Bump height depends on pixel luminosity and you can set light direction. See [Emboss](#) for more information about embossing. You can bump map any type of image, unlike the Emboss filter.

17.13.2.2 Activate the filter

This filter is found in the image window menu under Filters → Map → Bump Map....

17.13.2.3 Options

Figure 17.283 “Bump Map” filter options



Presets, Preview, Split view

Note



These options are described in Section [17.2](#).

Aux. Input Clicking on this button opens a small file browser with two panels. On the left panel, images present on your screen are listed: the active image is selected. On the right panel, you see the layers list of the active image: double click on the layer you want to use as a map for bump-mapping; the file browser is closed and a layer thumbnail appears in the Aux Input button.

The right panel has a “Channel” tab: TODO

Type This option allows you to define the method that will be used when creating the map image:

Linear Bump height is a direct function of luminosity.

Spherical Bump height is a spherical function of luminosity.

Sinusoidal Bump height is a sinusoidal function of luminosity.

Compensate Bump-mapping tends to darken image. You can compensate this darkening by checking this option.

Invert Bright pixels default to bumps and dark pixels to hollows. You can invert this effect by checking this option.

Tiled If you check this option, there will be no relief break if you use your image as a pattern for a web page: patterns will be placed side by side without any visible joins.

Azimuth This is about lighting according to the points of the compass (0 - 360). East (0°) is on the left. Increasing value goes counter-clockwise.

Elevation That's height from horizon (0.50°), up to zenith (90°).

Depth With this slider, you can vary bump height and hollow depth. The higher the value, the higher the difference between both. Values vary from 1 to 65.

Offset X, Offset Y With this slider, you can adjust the map image position compared with the image, horizontally (X) and/or vertically (Y).

Waterlevel If your image has transparent areas, they will be treated like dark areas and will appear as hollows after bump-mapping. With this slider, you can reduce hollows as if sea level was raising. This hollows will disappear when sea level value reaches 255. If the Invert bump-map option is checked, transparent areas will be treated as bright areas, and then Waterlevel slider will plane bumps down.

Ambient lighting factor This slider controls the intensity of ambient light. With high values, shadows will fade and relief lessen.

Clipping The result of this filter can be larger than the original image. With the default Adjust option, the layer will be automatically resized as necessary when the filter is applied. With the Clip option the result will be clipped to the layer boundary.

17.13.2.4 Using Bumpmap filter

We shall emboss an image with a text.

1. Open your main image.
2. Create the map: here a white text on black background.



The image and the map

3. **Edit/Copy the map.** Activate the image and **Edit/Past as/New Layer.** Right click on the new layer and apply **Layer to Image Size** to make the layer the same size as the image.
4. The map layer being active, apply a Gaussian Blur. Here, the default 1.5 pixels is used.
5. Make the map layer invisible and activate the image layer.
6. Open the "Bump Map" filter. Click on the Aux. Input button and double-click on the text layer in the right panel.

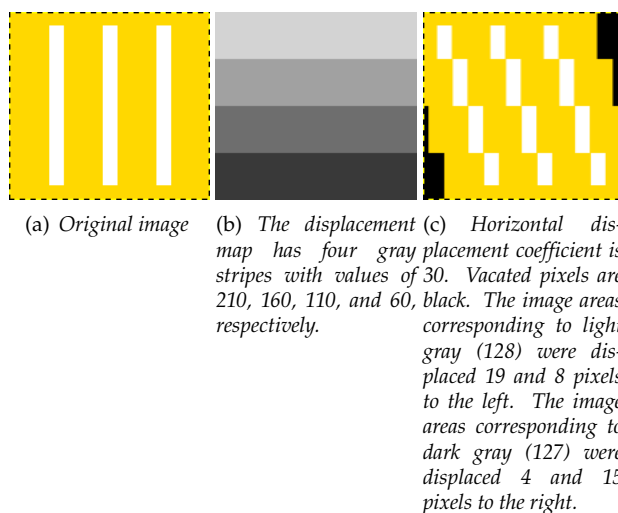


Bump Map filter applied. Depth = 3. Ambient lighting factor = 0.326.

17.13.3 Displace

17.13.3.1 Overview

Figure 17.284 Displacement examples



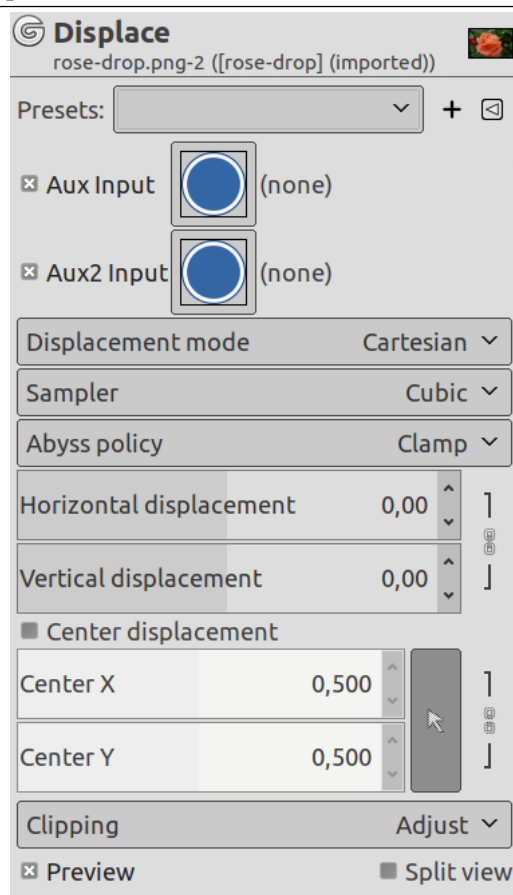
This filter uses a “displace-map” to displace corresponding pixels of the image. This filter displaces the content of the specified drawable (active layer or selection) by the amounts specified in Horizontal and vertical Displacement multiplied by the intensity of the corresponding pixel in the “displace map” drawables. *Both Horizontal and Vertical displace maps should be gray-scale images and have the same size as the drawable*. This filter allows interesting distortion effects.

17.13.3.2 Activating the filter

You can find this filter through Filters → Map → Displace...

17.13.3.3 Options

Figure 17.285 Displace filter options



Presets, Preview, Split view

Note



These options are described in Section [17.2](#).

Aux Input, Aux2 Input Clicking on a question mark button opens a small file browser with two panels. The left panel shows images present on your screen. The right panel shows the layers of the selected image. Double click on the wanted layer to select the map.

You can select different maps for Horizontal and Vertical displacements.

Displacement Mode You can choose working in **Cartesian** coordinates, where pixels are displaced in Horizontal or Vertical direction, or working in **Polar** coordinates, where the image is pinched and whirled by displacing pixels in radial or tangent direction.

Please see the next sections for details about these options.

Sampler Interpolation methods are described in [Transform tools](#)

Abyss policy These options allows you to set displacement behavior on active layer or selection edges. They are described in [Abyss policy](#)

Clipping The result of this filter can be larger than the original image. With the default Adjust option, the layer will be automatically resized as necessary when the filter is applied. With the Clip option the result will be clipped to the layer boundary.

17.13.3.3.1 Cartesian Displacement Mode

Figure 17.286 Displace filter options (Cartesian)



Horizontal and vertical displacements are 20 pixels

In both modes, direction and amount of displacement depend on the intensity of the corresponding pixel in the displacement map.

The map, that should be a grayscale image, has 256 gray levels (0-255), the (theoretical) average value is 127.5. The filter displaces image pixels corresponding to pixels with values less than 127.5 (0 to 127) in map to one direction, corresponding to pixels with values from 128 to 255 to the opposite direction.

Horizontal displacement, Vertical displacement If the respective option is activated, image pixels corresponding to pixels from 0 to 127 will be displaced to the right for Horizontal, downwards for Vertical, image pixels corresponding to pixels from 128 to 255 will be displaced to the left for Horizontal, upwards for Vertical.

What you enter in input boxes, directly or by using arrow-head buttons, is not the actual displacement. It's a coefficient used in a $displacement = (intensity \times coefficient)$ formula, which gives the pixel actual displacement according to the scaled intensity⁶ of the corresponding pixel in map, modulated by the coefficient you enter. Introducing intensity into formula is important: this allows progressive displacement by using a gradient map.

This value may be positive or negative. A negative displacement is reverse of a positive one. The value varies in limits equal to the double of image dimensions.

When you click on the drop-down list button, a list appears where you can select a displacement map. To be present in this list, an image must respect two conditions. First, this image must be present on your screen when you call filter. Then, this image must have the same dimensions as the original image. Most often, it will be a duplicate original image, which is transformed to gray scale and modified appropriately, with a gradient. It may be possible to use RGB images, but color luminosity is used making result prevision difficult. Map may be different in horizontal and vertical directions.

17.13.3.3.2 Polar Displacement Mode

Figure 17.287 Displace filter options (Polar)



Polar mode: Pinch only (chain broken)

Pinch If this option is activated, the radial coordinates (i.e. the distance to the image's midpoint, the "pole") of the pixels will be changed. Image pixels corresponding to map pixels from 0 to 127

⁶Scaled intensity = (intensity - 127.5) / 127.5; see Section 17.13.3.6.

will be displaced outwards, image pixels corresponding to pixels from 128 to 255 will be displaced towards center.

For the values and the displacement map see above (“Horizontal/Vertical displacement”).

The displacement is independent from the polar distance, all pixels are displaced by the same amount. So the image will not only be stretched or compressed, but also distorted:

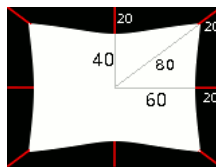


Image distortion by Pinch option

A 160x120 pixels image, plain white displacement map, and displacement coefficient 20.0: this results in a 20 pixels displacement towards center. This is a horizontal reduction in size by 25%, vertical by 33%, and diagonal by 20%, so the image will be distorted.

Whirl If this option is activated, the angular coordinates of the image pixels will be “displaced” by a map pixel dependent amount. For a plain displacement map, the image will be rotated, otherwise it will be whirled.

Image pixels corresponding to pixels from 0 to 127 in the map will be displaced counterclockwise, image pixels corresponding to pixels from 128 to 255 will be displaced clockwise.

For the values and the displacement map see above.

Note



For a plain, non neutral map, if displace mode “Polar” is enabled, this filter works like **Whirl and Pinch**.

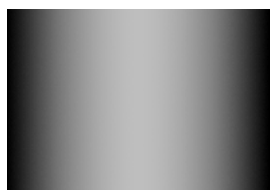
17.13.3.3 Center displacement

This option is used with Polar displacement: you can fix the displacement center.

17.13.3.4 Using gradient to bend a text

Follow following steps:

1. Start with opening your image.
2. Duplicate this image. Activate this duplicate and make it gray-scaled (Image → Mode → GrayScale). Fill it with the wanted gradient. This image will be your *Displacement map*, with the dimensions of original image.



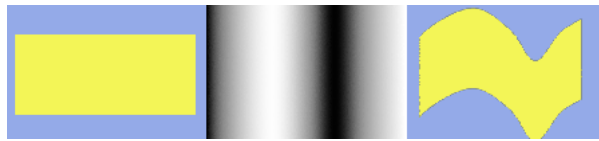
3. Activate original image. Create a *Text Layer* with your text. Set layer to image size: right-click on the layer in layer dialog and, in the pop-menu, click on “Layer to image size”. Note that letters in text layer lie on a transparent background; now this filter doesn’t displace transparent pixels. Only letters will be displaced.



4. Activate the text layer. Open the Displace filter window. Set parameters, particularly the displacement coefficient, according to the result in Preview. Click OK.



This method also applies to standard layers:



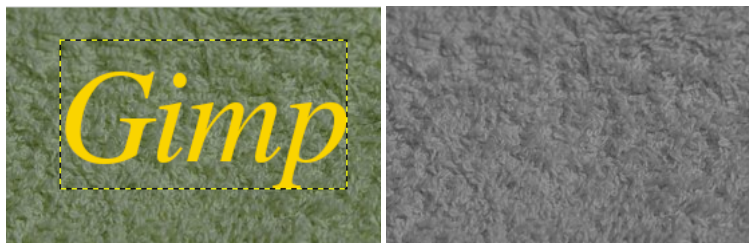
Tip



To get the wanted gradient, first draw a black to white gradient. Then use the **Curves** tool to modify the gradient curve.

17.13.3.5 Using Displace filter to fit a text to an uneven surface

Figure 17.288 Images example



(a) *Texture and Text*

(b) *Map*

Follow following steps:

1. Open the image with an uneven texture.
2. **Create the map:** Duplicate the image and desaturate (Colors/Desaturate/Desaturate) this copy.
3. **Create the text** in Texture image. Move it if necessary. Make this text layer the same size as the image using **Layer to Image Size**
4. Open "Displace" filter. Click on the Aux. Input button and double-click on the map image thumbnail in the left panel.



Displace filter applied.

17.13.3.6 Displacement Calculation

The following section will show you how to calculate the amount of displacement, if you are interested in these details. If you don't want to know it, you can safely omit this section.

The overview example showed the horizontal displacement using a coefficient of 30.0: 19, 8, 4, or 15 pixels, depending on the gray level of the displacement map's color.

Why just these amounts? That's easy:

$$30.0 * \frac{I-127.5}{127.5} = D$$

$$30.0 * \frac{210-127.5}{127.5} = 19$$

$$30.0 * \frac{(160-127.5)}{127.5} = 8$$

$$30.0 * \frac{(110-127.5)}{127.5} = -4$$

$$30.0 * \frac{(60-127.5)}{127.5} = -15$$

If you check these equations, you will notice that the values they give are not exactly the results we retained in the example (using non-integers, that's not surprising). So, were the results rounded to the nearest integer and then the pixels were displaced by a whole-numbered amount? No. Every pixel is displaced exactly by the calculated amount; a "displacement by a fractional amount" is realized by interpolation. A closer look at the example image will show it:

Figure 17.289 A closer look at the displacement example



A small area zoomed in by 800 percent.

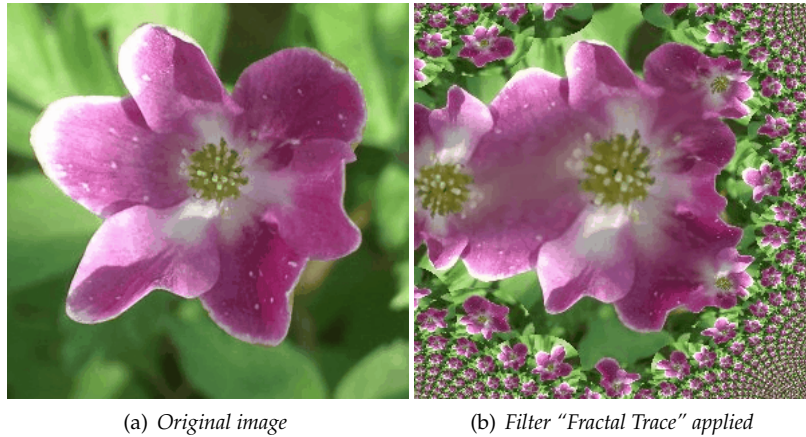
The displacement causes small (one pixel wide) areas of intermediate colors at the edges of plain color areas. E.g., the black area (zoomed in image) is caused by a displacement of -4.12, so the intermediate color is 12% black and 88% gold.

So if you select a displacement coefficient of 30.01 instead of 30.00, you will indeed get a different image, although you won't see the difference, of course.

17.13.4 Fractal Trace

17.13.4.1 Overview

Figure 17.290 Fractal Trace



(a) Original image

(b) Filter "Fractal Trace" applied

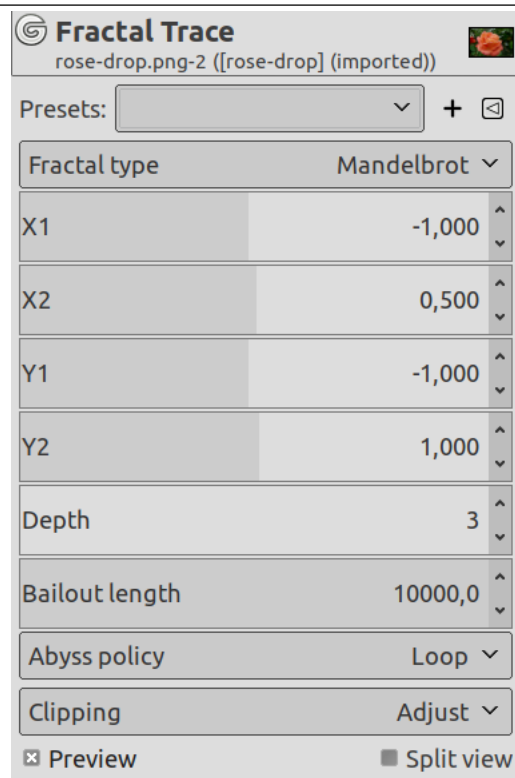
This filter transforms the image with the Mandelbrot fractal: it maps the image to the fractal.

17.13.4.2 Activate the filter

This filter is found in the image window menu under Filters → Map → Fractal trace...

17.13.4.3 Options

Figure 17.291 "Fractal trace" filter options



Options

Fractal type You choose between “Mandelbrot” and “Julia”.

X1, X2, Y1, Y2, Depth These parameters are similar to Left, Right, Top, Bottom and Iterations parameters of the **Fractal Explorer** filter. They allow you to vary fractal spreading and detail depth.

JX, JY Julia’s options: TODO

Bailout length TODO

Abyss policy Mapping image to fractal may reveal empty areas. These options allows you to set displacement behavior on active layer or selection edges. They are described in **Abyss policy**

Clipping The result of this filter can be larger than the original image. With the default Adjust option, the layer will be automatically resized as necessary when the filter is applied. With the Clip option the result will be clipped to the layer boundary.

17.13.5 Illusion

17.13.5.1 Overview

Figure 17.292 Illusion



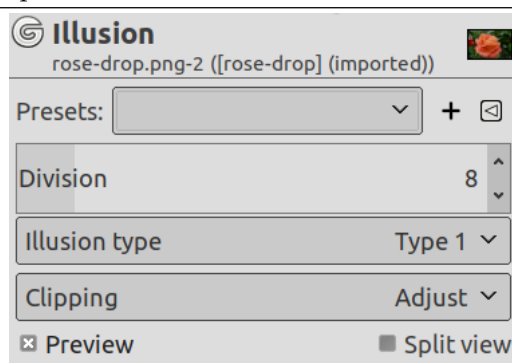
With this filter, your image (active layer or selection) looks like a kaleidoscope. This filter duplicates your image in many copies, more or less dimmed and split, and puts them around the center of the image.

17.13.5.2 Activate the filter

This filter is found in the image window menu under Filters → Map → Illusion....

17.13.5.3 Options

Figure 17.293 “Illusion” filter options



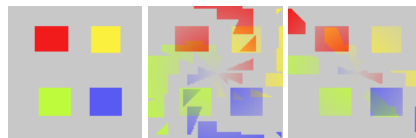
Presets, Preview, Split view**Note**

These options are described in Section 17.2.

Division That's the number of copies you want to apply to image. This value varies from -32 to 64. Negative values invert kaleidoscope rotation.

Illusion type You have two arrangement types for copies in image:

Figure 17.294 From left to right: original image, Type 1, Type 2, with Divisions=4



Clipping The result of this filter can be larger than the original image. With the default Adjust option, the layer will be automatically resized as necessary when the filter is applied. With the Clip option the result will be clipped to the layer boundary.

17.13.6 Little Planet

17.13.6.1 Overview

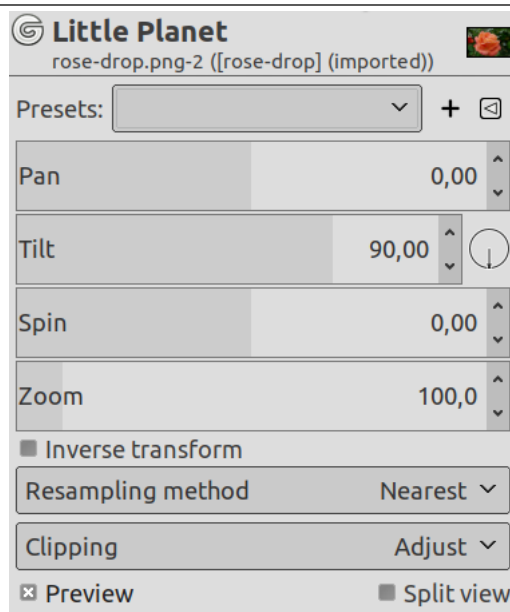
This filter converts a panorama into a small planet. All images don't fit this filter. The ideal image is a 360° x 180° image, also known as equirectangular image. We will see that it is possible to use normal images also.

17.13.6.2 Activate the filter

This filter is found in the image window menu under Filters → Map → Little Planet....

17.13.6.3 Options

Figure 17.295 “Little Planet” filter options



Options

Presets, Preview, Split view

Note



These options are described in Section 17.2.

Pan Horizontal camera panning. If “Inverse transform” option is checked, the “pan” option moves line of sight horizontally. Else, it works as “Spin” option.

Tilt Vertical camera panning. Moves line of sight upwards/downwards.

Spin Spin angle around camera axis. Rotates planet around line of sight.

Zoom Zoom level. Zooms planet in/out.

Inverse transform Do the inverse mapping; useful for touching up zenith, nadir or other parts of panorama.

Resampling method Interpolation methods are described in [Interpolation](#)

“Cubic” may give better result.

Clipping The result of this filter can be larger than the original image. With the default Adjust option, the layer will be automatically resized as necessary when the filter is applied. With the Clip option the result will be clipped to the layer boundary.

17.13.6.4 Using Little Planet filter with an equirectangular image

Tip



You can find free equirectangular images at https://commons.wikimedia.org/wiki/Category:360°_panoramas_with_equirectangular_projection.



Ettling_Isar_panorama.jpg by © Simon Waldherr under CC by-sa 4.0

GIMP opened this 16000x8000 pixels original image in a 1000x500 px frame at zoom 6.25. This is a screenshot scaled to 600x300 px. Note the empty sky, the horizon perfectly horizontal, the vanishing perspective.

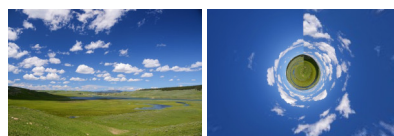


Filter applied

17.13.6.5 Using Little Planet filter with a normal image

Your panorama rarely satisfies conditions necessary for this filter, especially if you cut it off a larger image. The Little Planet filter brings left and right image sides together, and creates an unwanted sharp limit if sides are different. An uneven horizon gives an irregular circle. A blue empty sky occupying the upper half of the image and a horizontal horizon are perfect. Usually, you will have to prepare your panorama before using filter.

Figure 17.296 Original Images

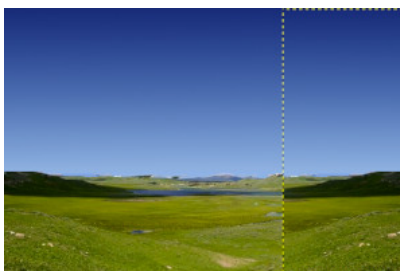


(a) panorama

Original (b) Filter applied directly with default options

1. Wipe sky: with Color Picker, darker blue to toolbox foreground and lighter blue to toolbox background. Rectangular selection of sky including a small part of horizon. In the selection, draw a Gradient from top to bottom.
2. Select the left border of the image.
3. Copy the selection and Paste it as New layer.

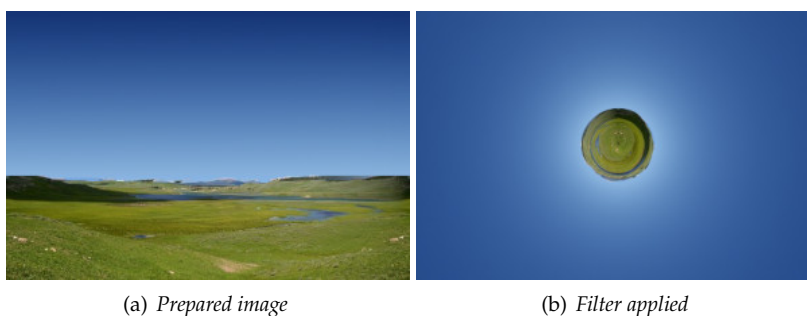
4. **Q** shortcut to open the Align tool.
5. Click on new layer (superimposed on selection area): new layer limits appear. Align new layer to image right side.
6. Select>None.
7. Flip new layer horizontally.



New layer aligned to image right side and flipped: left and right image sides are now the same. Sky wiped out. Horizon horizontalized.

8. Add a black Layer Mask to new layer.
9. Apply a black-to-white gradient to layer mask.
10. Apply Little planet filter.

Figure 17.297 Results



17.13.7 Panorama Projection

17.13.7.1 Overview

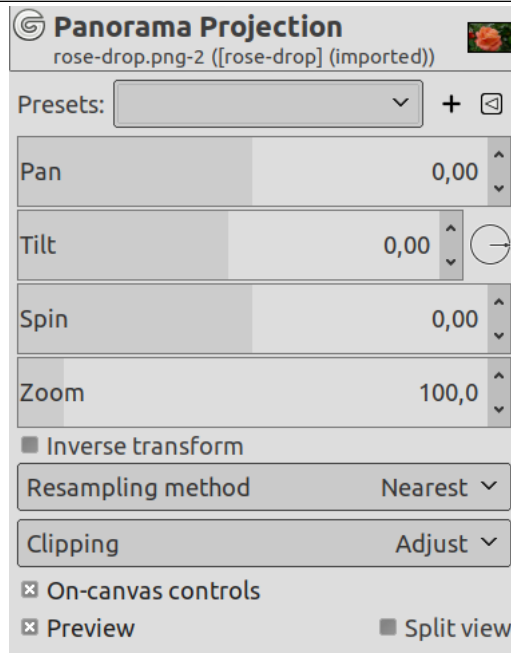
This filter converts a $360^\circ \times 180^\circ$ image, also known as equirectangular image, into a panorama.

17.13.7.2 Activate the filter

This filter is found in the image window menu under Filters → Map → Panorama Projection....

17.13.7.3 Options

Figure 17.298 “Panorama Projection” filter options



These options are the same as Section 17.13.6 options.

17.13.7.4 Key Modifiers

Click and drag to pan.

Shift + Click and drag to rotate.

Ctrl + Click and drag to pan with a constrained axis.

Alt + Click and drag to zoom.

17.13.7.5 Using Panorama Projection filter

Tip



You can find free equirectangular images at https://commons.wikimedia.org/wiki/Category:360°_panoramas_with_equirectangular_projection.

Of course, you can get only a part of the original image in your panorama. The first thing you have to do is creating a new image with the size of your future panorama. Then, open the original image.



Parc_de_Belleville,_Paris_June_2007.jpg by Alexandre Duret-Lutz under [CC by-sa 4.0](https://creativecommons.org/licenses/by-sa/4.0/)

GIMP opened this 4000x2000 pixels original image in a 1000x500 px frame at zoom 12.5. This is a screenshot scaled to 400x200 px.

Open the Panorama Projection filter. Only the central part of the image is visible. Pan across the image to find your panorama using the Pan option or click and dragging. You can zoom in to have a wider view.

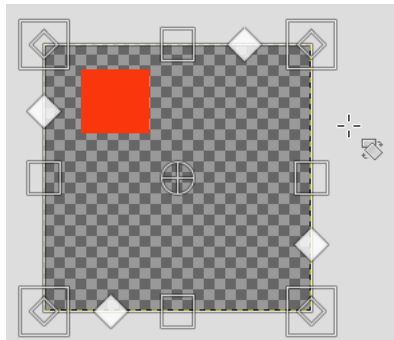
Figure 17.299 “Panorama Projection” filter applied



17.13.8 Recursive Transform

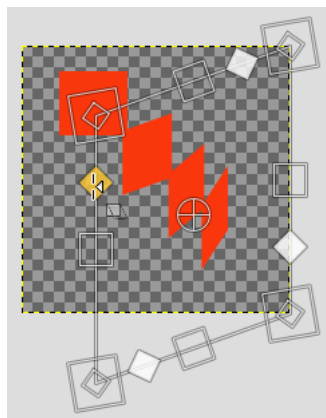
17.13.8.1 Overview

This filter applies a transformation recursively.




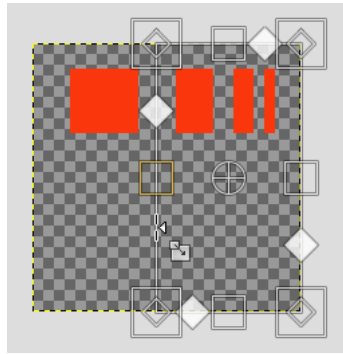
As in Unified Transform tool, this filter display a frame around the image with several kind of handles:

-  Diamonds for shearing



Shear

-  Squares for scaling horizontally or vertically.



Scale horizontally


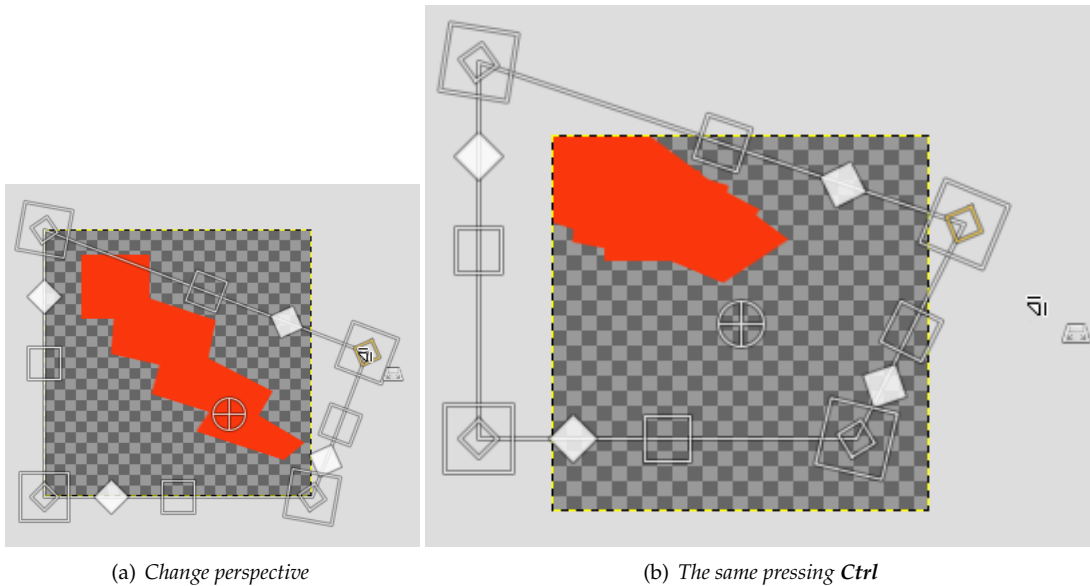
- 
 Small diamonds for changing perspective, in large squares for Scaling in all directions.

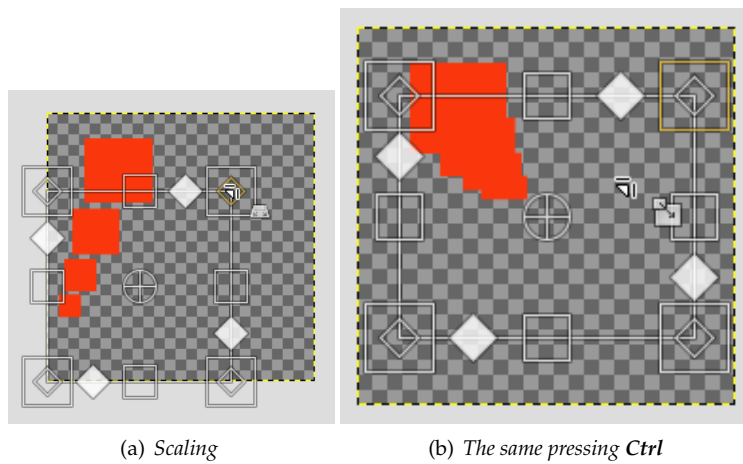
Figure 17.300 Changing perspective



(a) Change perspective

(b) The same pressing Ctrl

Figure 17.301 Scaling in all directions



(a) Scaling

(b) The same pressing Ctrl

and outside the frame, the mouse pointer comes with a rotation icon: click-and-drag to rotate around the

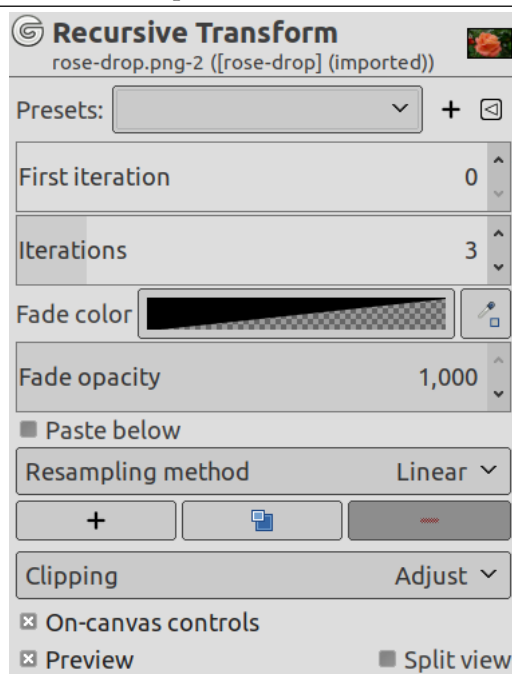
pivot. This pivot is, by default, at the center of the image: click-and-drag to move it.

17.13.8.2 Activate the filter

This filter is found in the image window menu under Filters → Map → Recursive Transform....

17.13.8.3 Options

Figure 17.302 “Recursive Transform” filter options



Presets, Preview, Split view

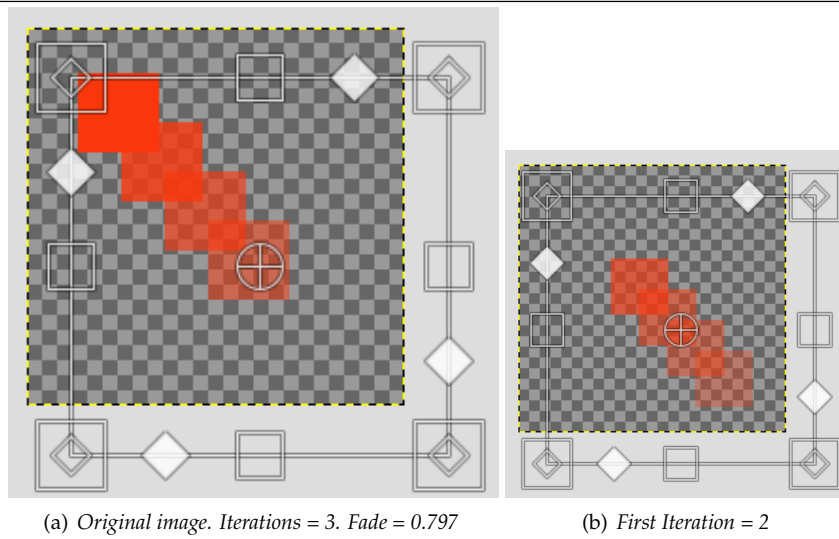
Note



These options are described in Section 17.2.

First iteration This option is used when the number of iterations has been set. Then the transformation starts at the position determined by this option.

Figure 17.303 “Recursive Transform” filter options



Iterations Number of iterations.

Fade color The color that will be used to fade. Default is transparency. You can change this color selecting a new color by clicking in the color swatch or using the color picker on the right.

Fade opacity Amount by which to scale opacity of each iterated image.

Paste below Paste iterated images below each other.

Resampling method Interpolation methods are described in [Interpolation](#)

Three buttons To add, duplicate or remove transform.

Clipping The result of this filter can be larger than the original image. With the default Adjust option, the layer will be automatically resized as necessary when the filter is applied. With the Clip option the result will be clipped to the layer boundary.

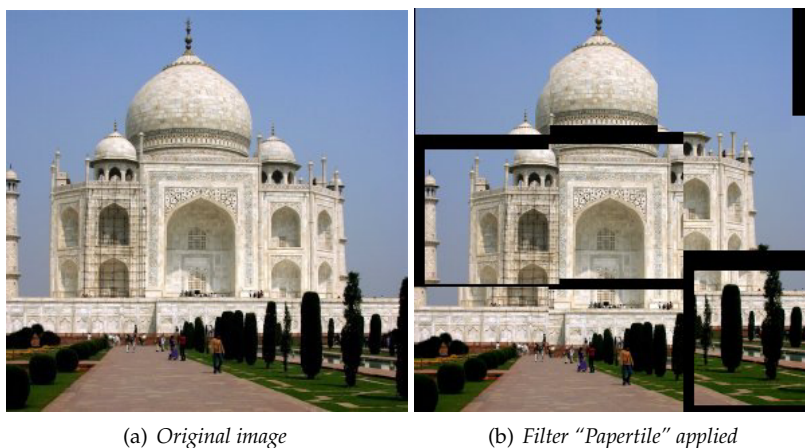
17.13.8.4 Using Recursive Transform Filter

You can use this filter to create a Droste effect, 3D effects, trees.

17.13.9 Paper Tile

17.13.9.1 Overview

Figure 17.304 “Papertile” filter example.



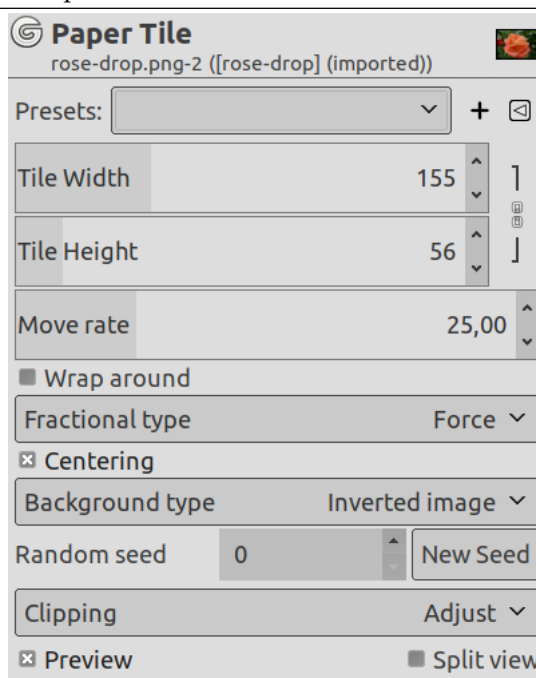
This filter cuts the image (active layer or selection) into several pieces, with square form, and then slides them so that they, more or less, overlap or move apart. They can go out image borders a little.

17.13.9.2 Activate the filter

You can find this filter through Filters → Map → Paper Tile....

17.13.9.3 Options

Figure 17.305 “Paper Tile” filter options



Presets, Preview, Split view

Note



These options are described in Section 17.2.

Tile Width/Height Filter starts cutting image before it displaces pieces; so, piece size and number of pieces in horizontal (Width) and vertical (Height) directions must be convenient to image size.

When these options are linked, tiles are square.

Move rate This is the maximum displacement percentage against the side size of squares.

Wrap around As tiles move, some can go out image borders. If this option is checked, what goes out on one side goes in on the opposite side.

Fractional type Because of image cutting, original pixels can persist. There are three ways treating them:

Force Remaining pixels will be cut also.

Ignore Background Type option is not taken into account and remaining pixels are kept.

Background Remaining pixels will be replaced with the background type defined in the following section.

Centering If this option is checked, tiles will rather be gathered together in the center of the image.

Background Type You can select the background type which will be used, if the Background radio-button is checked, among six options:

Inverted image Background colors will be inverted (255-value in every color channel).

Transparent Background will be transparent.

Image Background colors will be unchanged. The original image is the background.

Color Remaining pixels will be replaced by the color you can select. Default is the Foreground color of toolbox. You can choose another color using the color dwell or the color picker.

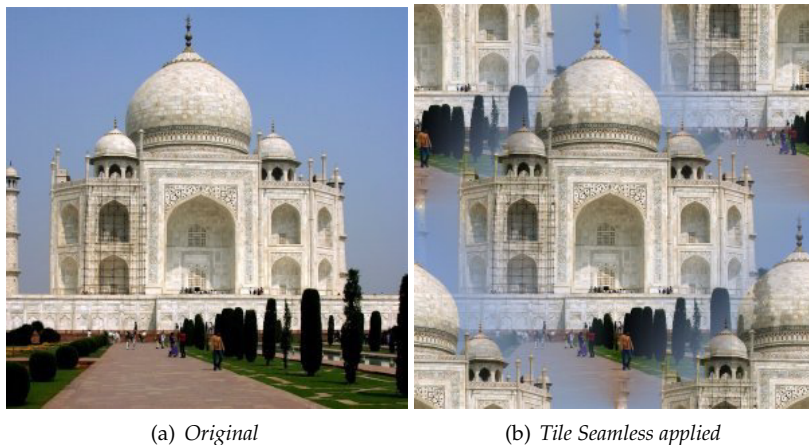
Random seed Tile displacement can be done at random.

Clipping The result of this filter can be larger than the original image. With the default Adjust option, the layer will be automatically resized as necessary when the filter is applied. With the Clip option the result will be clipped to the layer boundary.

17.13.10 Tile Seamless

17.13.10.1 Overview

Figure 17.306 An example of Tile Seamless.



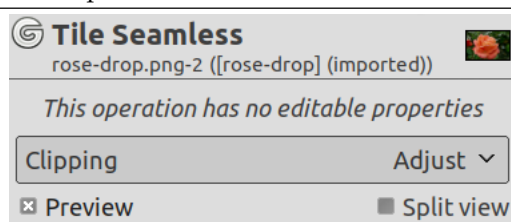
This filter modifies the image for tiling by creating seamless edges. Such an image can be used as a pattern for a web-page. This filter has no option, and result may need correction.

17.13.10.2 Activation

You can find this filter through Filters → Map → Tile Seamless...

17.13.10.3 Options

Figure 17.307 "Tile Seamless" filter options



17.13.11 Fractal Trace (legacy)

17.13.11.1 Overview

Figure 17.308 Fractal Trace (legacy)



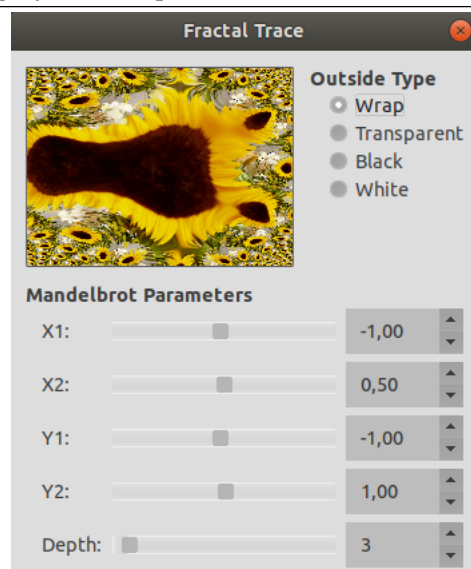
This filter transforms the image with the Mandelbrot fractal: it maps the image to the fractal.

17.13.11.2 Activate the filter

This filter is found in the image window menu under Filters → Map → Fractal trace (legacy)....

17.13.11.3 Options

Figure 17.309 "Fractal trace (legacy)" filter options



Mandelbrot parameters

X1, X2, Y1, Y2, Depth These parameters are similar to X/YMIN, X/YMAX and ITER parameters of the **Fractal Explorer** filter. They allow you to vary fractal spreading and detail depth.

Outside Type Mapping image to fractal may reveal empty areas. You can select to fill them with Black, White, Transparency or make what disappears on one side reappear on the opposite side with Wrap option.

17.13.12 Map Object

17.13.12.1 Overview

Figure 17.310 The “Map Object” filter applied to a photograph



(a) *Original*



(b) “Map Object” applied

This filter maps a picture to an object (plane, sphere, box or cylinder).

17.13.12.2 Activate the filter

This filter is found in the image window menu under Filters → Map → Map Object...

17.13.12.3 Options

17.13.12.3.1 Preview

This preview has several possibilities:

Preview! Preview is automatic for some options but you will have to press this button to update Preview after modifying many other parameters.

When mouse pointer is on Preview and the Light tab is selected, it takes the form of a small hand to grab the *blue point* which marks light source origin and to displace it. This blue point may not be visible if light source has negative X and Y settings in the Light tab.

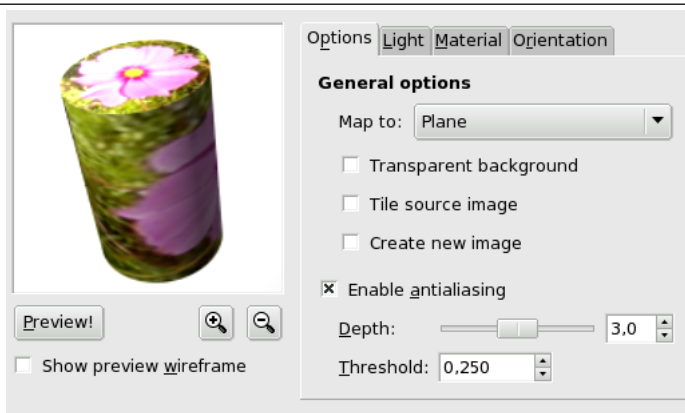
Zoom out, Zoom in Zoom buttons allow you to enlarge or to reduce image in Preview. Their action is limited, but may be useful in case of a large image.

Show preview wireframe Puts a grid over the preview to make displacements and rotations more easy. Works well on a plan.

Update preview live To have preview working as usual.

17.13.12.3.2 General Options

Figure 17.311 “Map Object” options (General)



Map to This drop-down list allows you to select the object the image will be mapped on. It can be a *Plane*, a *Sphere*, a *Box* or a *Cylinder*.

Transparent background This option makes image transparent around the object. If not set, the background is filled with the current background color.

Tile source image When moving *Plane* object and displacing it with *Orientation* tab options, a part of the image turns empty. By checking the *Tile source image*, source image copies will fill this empty space in. This option seems not to work with the other objects.

Note



This option works with “Plane” only.

Create new image When this option is checked, a new image is created with the result of filter application, so preserving the original image.

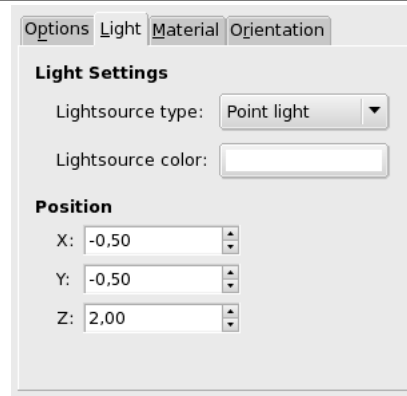
Enable antialiasing Check this option to conceal this unpleasant aliasing effect on borders. When checked, this option lets appear two settings:

Depth Defines antialiasing quality, to the detriment of execution speed.

Threshold Defines antialiasing limits. Antialiasing stops when value difference between pixels becomes lower than this set value.

17.13.12.3.3 Light

Figure 17.312 “Map Object” options (Light)



Light Settings

Lightsource type In this dropdown list, you can select among *Point light*, *Directionnal light* and *No light*.

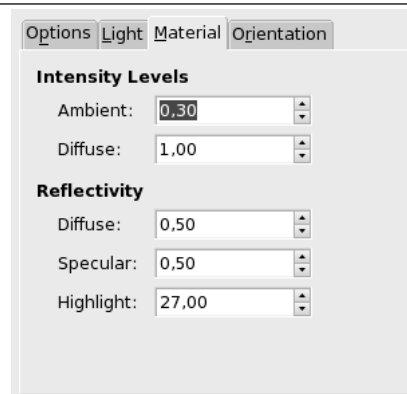
Lightsource color Press this button to open the Color Selector dialog.

Position If “Point light” is selected, you can control there light source *Position* (the blue point), according to X, Y and Z coordinates.

If “Directional light” is selected, these X, Y and Z parameters control the “Direction vector” (effect is not evident).

17.13.12.3.4 Material

Figure 17.313 “Map Object” options (Material)



Intensity Levels

Ambient Amount of color to show where no light falls directly.

Diffuse Intensity of original color when lit by a light source.

Reflectivity

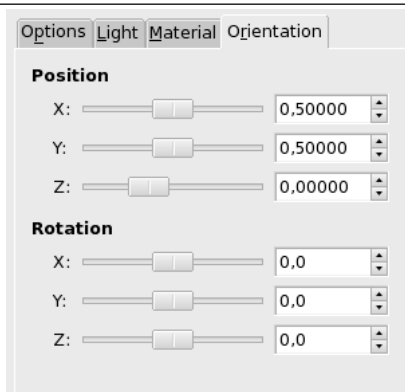
Diffuse Higher values make object reflect more light (looks brighter).

Specular Controls how intense the highlights will be.

Highlight Higher values make the highlights more focused.

17.13.12.3.5 Orientation

Figure 17.314 “Map Object” options (Orientation)



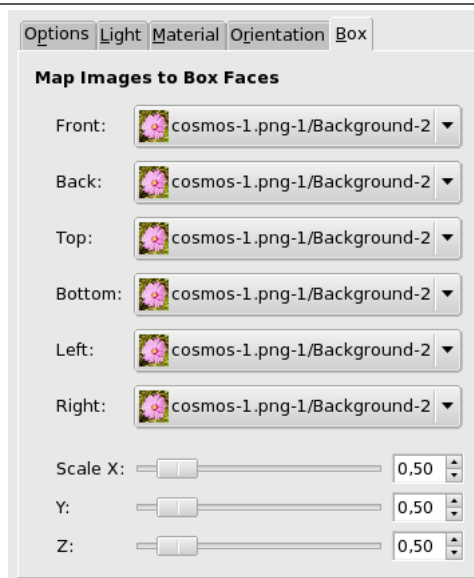
Position These three sliders and their input boxes allows you to vary object position in image, according to the X, Y, Z coordinates of the object upper left corner.

Rotation These three sliders make the object rotate around X, Y, Z axes respectively.

17.13.12.3.6 Box

This tab appears only when you select the Box object.

Figure 17.315 “Map Object” options (Box)

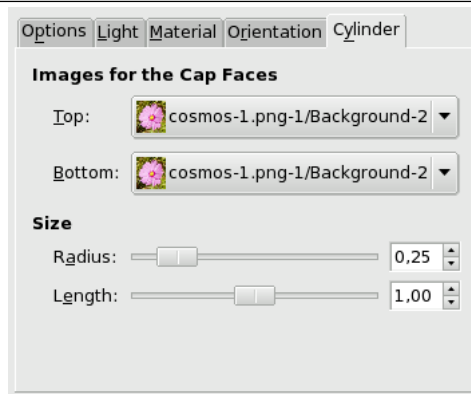


Match Images to Box Faces This function name is self explanatory: you can select an image for every face of the box. These images must be present on your screen when you call the Map Object filter.

Scale These X, Y, Z sliders allow you to change the size of every X, Y, Z dimension of the box.

17.13.12.3.7 Cylinder

This tab appears only when you select the Cylinder object.

Figure 17.316 “Map Object” options (Cylinder)

Images for the Cap Faces The name of this option is self-explanatory. Images must be present on your screen when you call the Map Object filter.

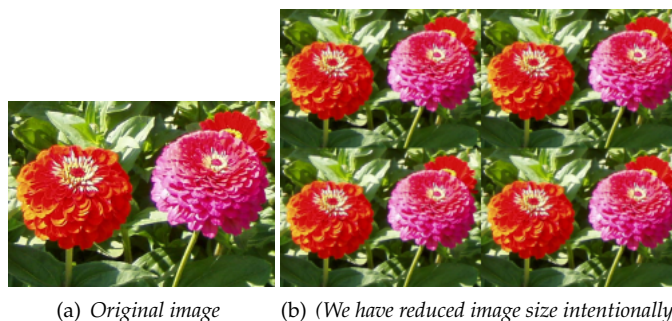
Size

Radius This slider and its input boxes let you control the Cylinder diameter. Unfortunately, this setting works on the image mapped onto the cylinder and resamples this image to adapt it to the new cylinder size. It would be better to have the possibility of setting size cylinder before mapping so that we could map a whole image.

Length Controls cylinder length.

17.13.13 Tile

17.13.13.1 Overview

Figure 17.317 The same image, before and after applying Tile filter

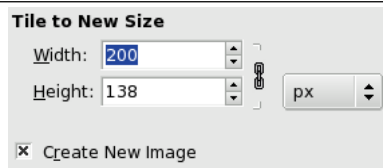
This filter makes several copies of the original image, in a same or reduced size, into a bigger (new) image.

17.13.13.2 Activate the filter

You can find this filter through Filters → Map → Tile....


17.13.13.3 Options

Figure 17.318 “Tile” filter options



Tile to New Size

Width, Height Input boxes and their arrow-heads allow you to enter the dimensions for the new image.

Both directions are linked by default with a chain . You can make them independent by breaking this chain. You can choose a unit else than pixel by clicking on the drop-down list button.

The new image must be bigger than the original one. Else, you will get an image sample only. Choose sizes which are multiple of original sizes if you don't want to have truncated tiles.

Create new image It's in your interest to keep this option checked to avoid modifying your original image.

17.14 Rendering Filters

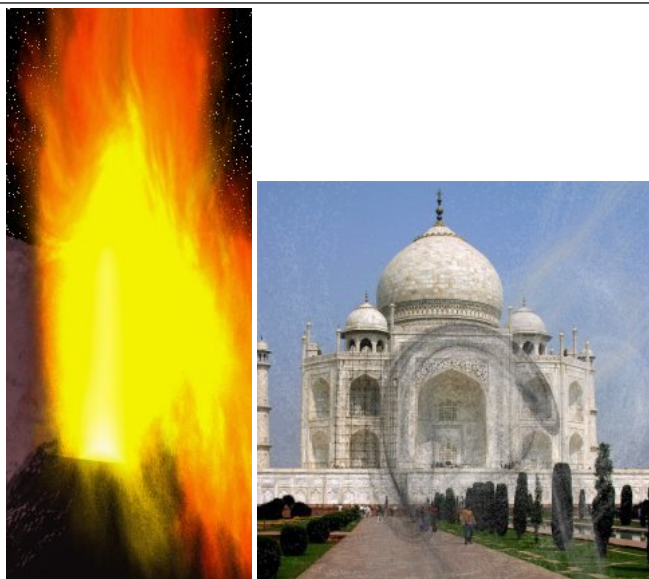
17.14.1 Introduction

Most GIMP filters work on a layer by transforming its content, but the filters in the “Render” group are a bit different. They create patterns from scratch, in most cases obliterating anything that was previously in the layer. Some create random or noisy patterns, others regular or fractal patterns, and one (Gfig) is a general-purpose (but rather limited) vector graphics tool.

17.14.2 Flame

17.14.2.1 Overview

Figure 17.319 Example of a rendered Flame



(b) Filter “Flame” applied

With the Flame filter, you can create stunning, randomly generated fractal patterns. You can't control the fractals as you can with the **IFS Fractal** filter, but you can steer the random generator in a certain direction, and choose from variations of a theme you like.

Warning



Unfortunately it turned out, that this filter is not working properly for large images. Even more unfortunate is, that its developer is currently not undertaking any actions with that plug-in at all, so there seems no quick fix in sight. Although we can't give you the exact numbers, the plug-in worked in a quick test for a 1024x768 pixel image, but didn't do it for a 2500x2500 pixel image.

Note



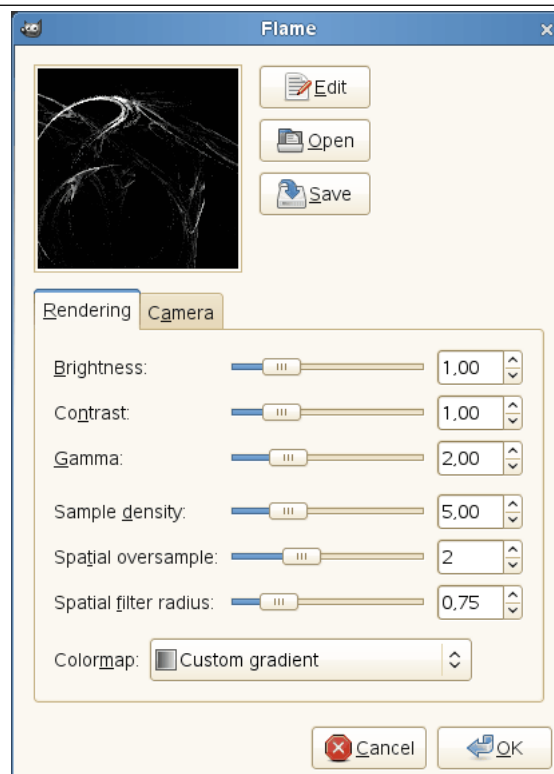
This plug-in was given to GIMP by Scott Draves in 1997. He also holds the copyright for the plug-in. An descriptive page for the plug-in, provided by the author can be found in the internet [[PLUGIN-FLAMES](#)].

17.14.2.2 Activating the filter

You can find this filter through Filters → Render → Fractals → Flame....

17.14.2.3 Options

Figure 17.320 "Flame" filter options

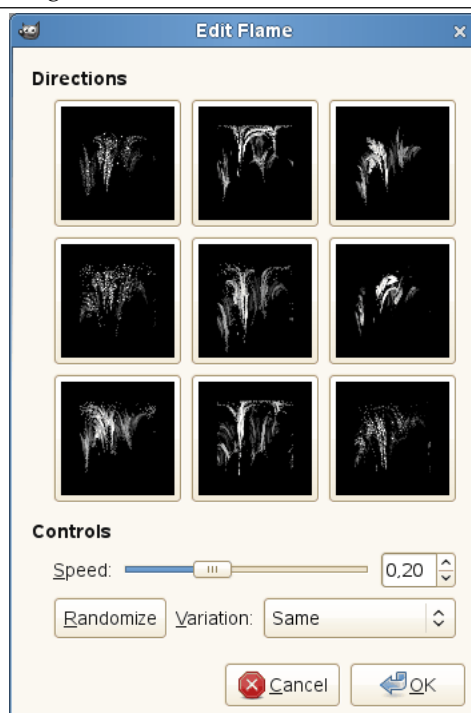


In the main window, you can set Rendering and Camera parameters. The first three parameters in the Render display are Brightness, Contrast and Gamma. The result of these options is visible in the Preview window, but it's generally better to stick to the default values, and correct the rendered image later with Image/Colors.

The other three parameters affect the rendering process and don't show in the preview window. Sample Density, which controls the resolution of the rendered pattern, is the most important of these. The Camera parameters allow you to zoom and offset the flame pattern, until you're happy with what you see in the preview window. Flame also offers the possibility to store and load your favorite patterns.

Edit Pressing this button brings up the Edit dialog:

Figure 17.321 The Edit Flame dialog

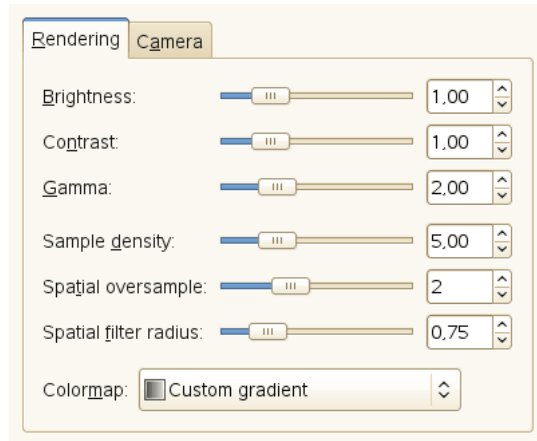


The dialog shows nine different windows. The pattern displayed in the center is the current pattern, and the eight windows surrounding it are random variations of that pattern. Clicking on the central image creates eight new variations, which can be adjusted with the Speed control. You select a variation by clicking on it, and it instantly replaces the image in the middle. To pick a certain character or theme for the variations, you can choose from nine different themes in the Variations menu. You can also use Randomize, which replaces the current pattern with a new random pattern.

Open This button brings up a file selector that allows you to open a previously saved Flame settings file.

Save This button brings up a file save dialog that allows you to save the current settings for the plug-in, so that you can recreate them later.

Rendering



Brightness Controls the brightness of the flame object.

Contrast Controls the contrast between brighter and dimmer parts of the flame.

Gamma Sets a gamma correction for parts with intermediate brightness.

Sample density Controls the resolution of the rendered pattern. (Does not have any effect on the preview.) A high sample density results in soft and smooth rendering (like a spider's web), whereas low density rendering resembles spray or particle clouds.

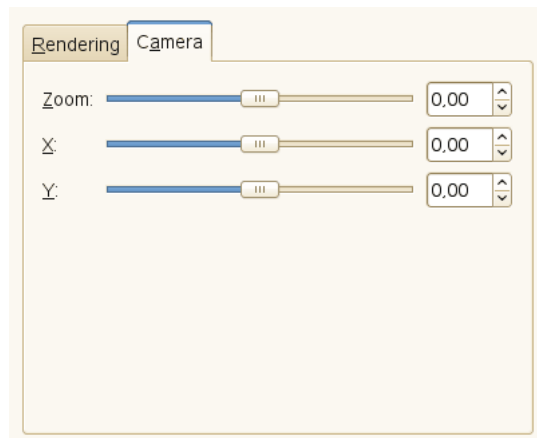
Spatial oversample What does this do?

Spatial filter radius What does this do?

Colormap This menu gives you several options to set the color blend in the flame pattern:

- The current gradient as shown in the Toolbox.
- A number of preset colormaps.
- The colors from images that are presently open in GIMP.

Camera



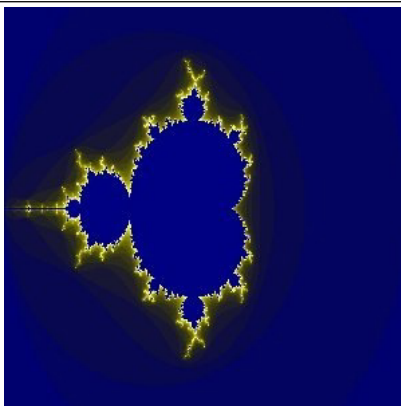
Zoom Allows you to zoom the flame in or out.

X, Y Allows you to move the flame around in the image area.

17.14.3 Fractal Explorer

17.14.3.1 Overview

Figure 17.322 Example for the Fractal Explorer filter



Filter “Fractal Explorer” applied

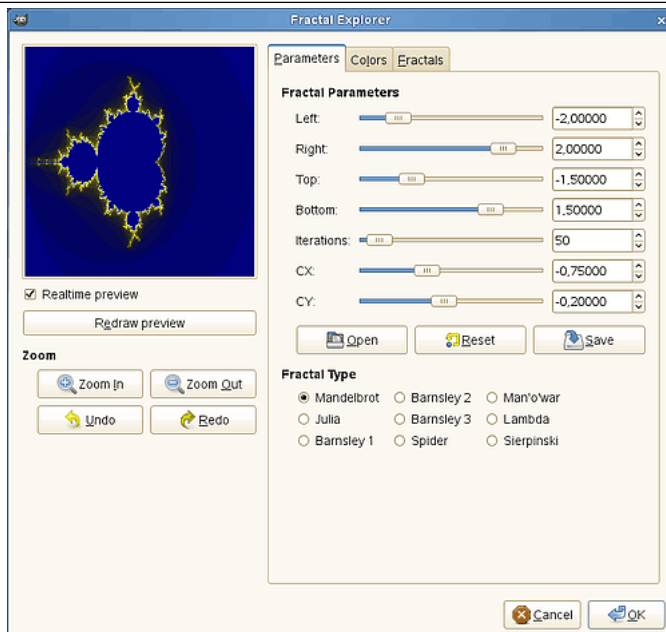
With this filter, you can create fractals and multicolored pictures verging to chaos. Unlike the **IFS Fractal** filter, with which you can fix the fractal structure precisely, this filter lets you perform fractals simply.

17.14.3.2 Starting filter

You can find this filter through Filters → Render → Fractal Explorer....

17.14.3.3 Options

Figure 17.323 “Fractal Explorer” filter options



The Fractal Explorer window contains two panes: on the left there is the Preview pane with a Zoom feature, on the right you find the main options organized in tabs: Parameters, Colors, and Fractals.

17.14.3.3.1 Preview

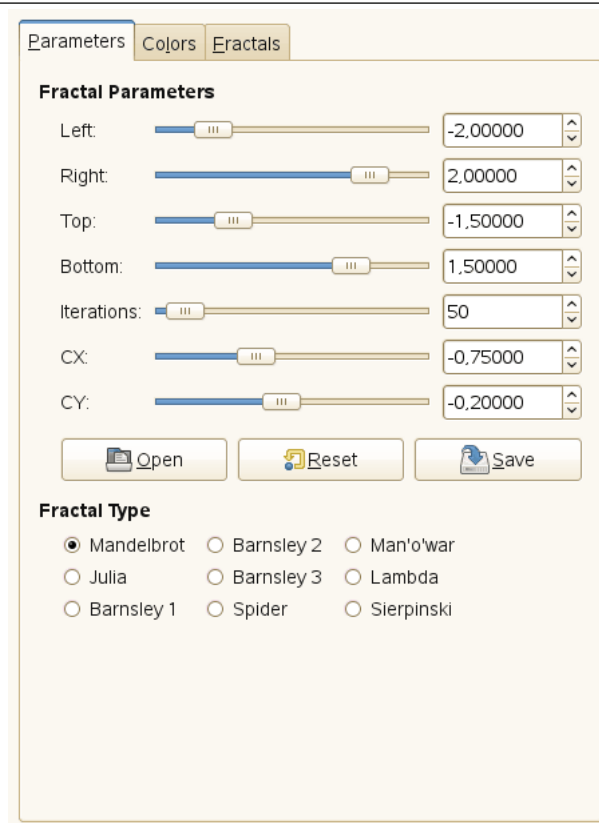
Realtime preview Uncheck the Realtime preview only if your computer is slow. In this case, you can update preview by clicking on the Redraw preview button.

By clicking-dragging mouse pointer on preview, you can draw a rectangle delimiting an area which will be zoomed.

Zoom You have there some options to zoom in or zoom out. The Undo allows you to return to previous state, before zooming. The Redo allows you to reestablish the zoom you had undone, without having to re-create it with the Zoom In or Zoom Out buttons.

17.14.3.3.2 Parameters

Figure 17.324 “Fractal Explorer” filter options (Parameters)



This tab contains some options to set fractal calculation and select fractal type.

Fractal Parameters Here, you have sliders and input boxes to set fractal spreading, repetition and aspect.

Left, Right, Top, Bottom You can set fractal spreading between a minimum and a maximum, in the horizontal and/or vertical directions. Values are from -3.0 to 3.0.

Iterations With this parameter, you can set fractal iteration, repetition and so detail. Values are from 0.0 to 1000.0

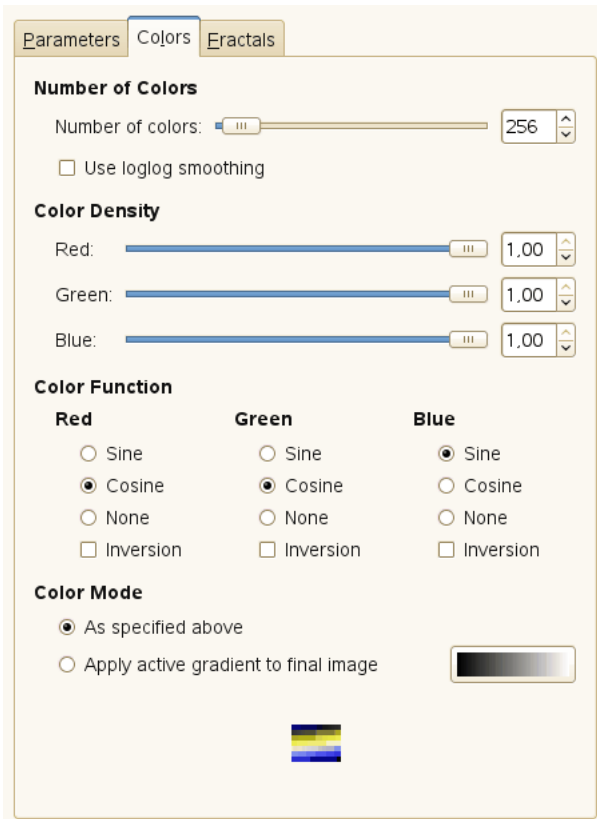
CX, CY With these parameters, you can change fractal aspect, in the horizontal (X) and/or vertical (Y) directions, except for Mandelbrot and Sierpinski types.

Open, Reset, Save With these three buttons, you can save your work with all its parameters, open a previously saved fractal, or return to the initial state before all modifications.

Fractal Type You can choose what fractal type will be, for instance Mandelbrot, Julia, Barnsley or Sierpinski.

17.14.3.3.3 Colors

Figure 17.325 “Fractal Explorer” filter options (Colors)



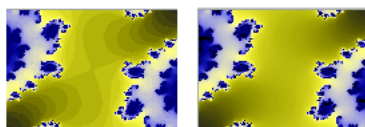
This tab contains options for fractal color setting.

Number of Colors

Number of colors This slider and its input boxes allow you to set the number of colors for the fractal, between 2 and 8192. A palette of these colors is displayed at the bottom of the tab. Actually, that's a gradient between colors in fractal: you can change colors with “Color Density” and “Color Function” options. Fractal colors don't depend on colors of the original image (you can use a white image for fractals as well).

Use loglog smoothing If this option is checked, the band effect is smoothed.

Figure 17.326 Loglog smoothing example



Color density

Red, Green, Blue These three sliders and their text-boxes let you set the color intensity in the three color channels. Values vary from 0.0 to 1.0.

Color Function

For the Red, Green and Blue color channels, you can select how color will be treated:

Sine Color variations will be modulated according to the sine function.

Cosine Color densities will vary according to cosine function.

None Color densities will vary linearly.

Inversion If you check this option, function values will be inverted.

Color Mode

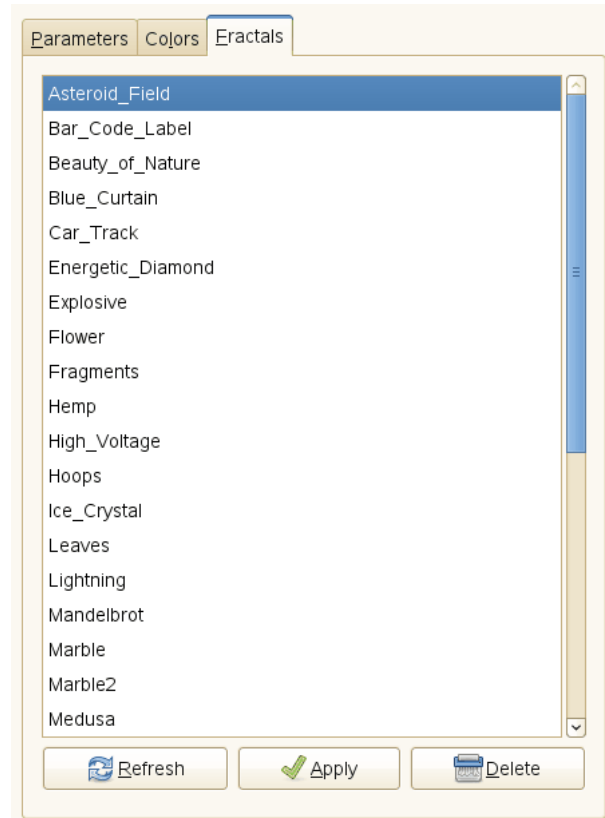
These options allow you to set where color values must be taken from.

As specified above Color values will be taken from the Color Density options.

Apply active gradient to final image Used colors will be that of active gradient. You should be able to select another gradient by clicking on the gradient source button.

17.14.3.3.4 Fractals

Figure 17.327 “Fractal Explorer” filter options (Fractals)



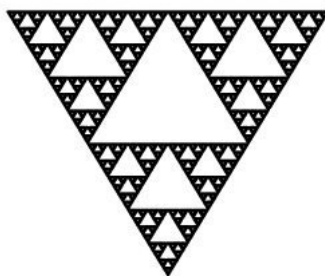
This tab contains a big list of fractals with their parameters, that you can use as a model: only click on the wanted one.

The Refresh allows you to update the list if you have saved your work, without needing to re-start GIMP. You can delete the selected fractal from the list by clicking on the Delete.

17.14.4 IFS Fractal

17.14.4.1 Overview

Figure 17.328 Applying example for the IFS Fractal filter



Filter “IFS Fractal” applied

This fractal-based plug-in is truly wonderful! With this versatile instrument, you can create amazingly naturalistic organic shapes, like leaves, flowers, branches, or even whole trees. (“IFS” stands for “Iterated Function System”.)

The key to use this plug-in lies in making very small and precise movements in fractal space. The outcome is always hard to predict, and you have to be extremely gentle when you change the pattern. If you make a component triangle too big, or if you move it too far (even ever so slightly), the preview screen will black out, or more commonly, you’ll get stuck with a big shapeless particle cloud.

A word of advice: When you have found a pattern you want to work with, make only small changes, and stick to variations of that pattern. It’s all too easy to lose a good thing. Contrary to what you might believe, it’s really much easier to create a leaf or a tree with IFS Fractal than to make a defined geometrical pattern (where you actually know what you’re doing, and end up with the pattern you had in mind).

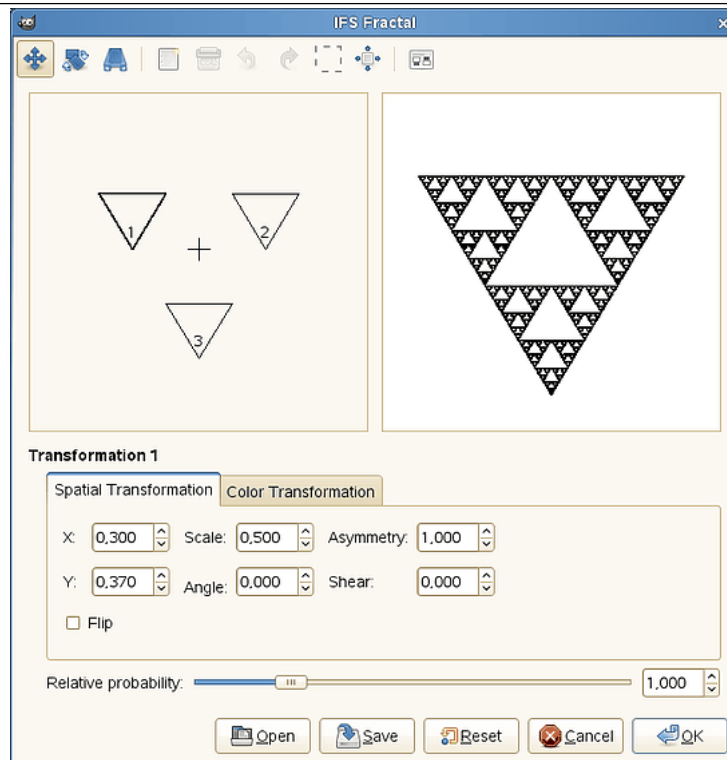
For a brief introduction to IFS’s see Foley and van Dam, et al., *Computer Graphics, Principles and Practice*[FOLEY01].

17.14.4.2 Activating the filter

This filter is found in the image window menu under Filters → Render → Nature → IFS Fractal....

17.14.4.3 Options

Figure 17.329 “IFS Fractal” filter options



The plug-in interface consists of the compose area to the left, a preview screen to the right, and some tabs and option buttons at the bottom of the dialog. The Default setting (in the preview window) is three equilateral triangles. (This gives rise to a fractal pattern called the *Sierpinski Triangle*).

Toolbar

Click on the toolbar buttons to use the following tools, or open the context menu of the compose area.

Move, Rotate/Scale, Stretch Select the action to perform using the (mouse) pointer.

New, Delete Add or remove fractals.

Undo, Redo Standard.

Select all Link fractals and let apply actions to all fractals.

Recenter Recompute the center of the fractals. This does not have any visible effect to the resulting fractal.

Render Options

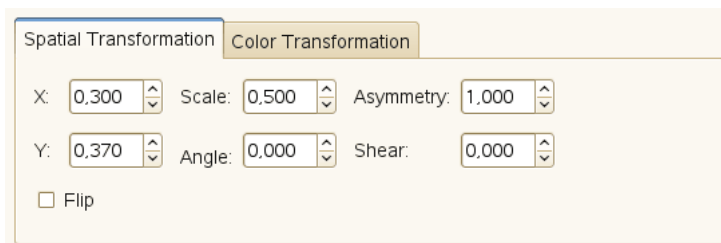
Max. memory Enables you to speed up rendering time. This is especially useful when working with a large spot radius; just remember to use even multiples of the default value: 4096, 8192, 16384, ...

Iterations Determines how many times the fractal will repeat itself. (A high value for Subdivide and Iterations is for obvious reasons a waste of process time unless your image is very large.)

Subdivide Controls the level of detail.

Spot radius Determines the density of the “brushstrokes” in the rendered image. A low spot radius is good for thin particle clouds or spray, while a high spot radius produces thick, solid color strokes much like watercolor painting. Be careful not to use too much spot radius — it takes a lot of time to render.

Spatial Transformation



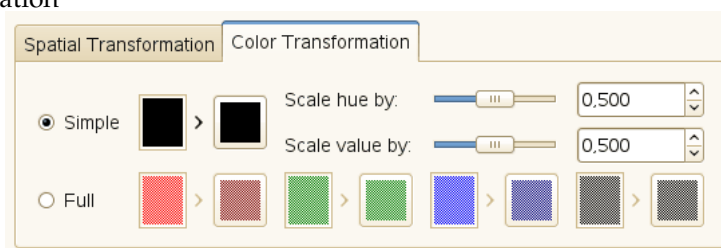
Gives you information on the active fractal, and allows you to type a value instead of changing it manually. Changing parameters with the mouse isn't very accurate, so this is a useful option when you need to be exact.

X, Y, Scale, Angle, Shear Move, scale, or shear the active fractal.

Asymmetry Stretch the active fractal.

Flip Flip the active fractal.

Color Transformation



Simple Changes the color of the currently selected fractal component (default is the foreground color in the toolbox) to a color of your choice.

Full Like the Simple color transformation but this time you can manage the color transformation for each color channel and for the alpha channel (shown as a black channel).

Scale hue by, Scale value by When you have many fractals with different colors, the colors blend into each other. So even if you set "pure red" for a fractal, it might actually be quite blue in some places, while another "red" fractal might have a lot of yellow in it. Scale Hue/Value changes the color strength of the active fractal, or how influential that fractal color should be.

Other

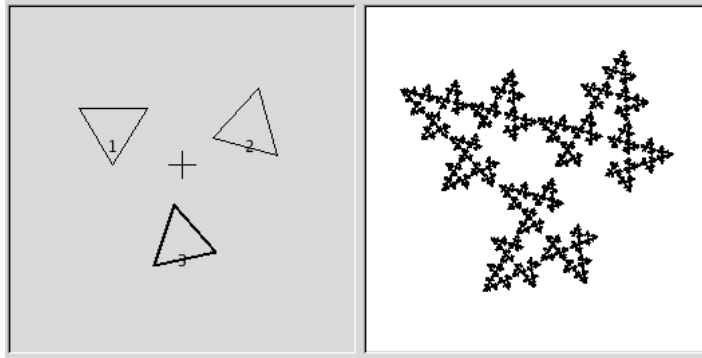
Relative probability Determines influence or total impact of a certain fractal.

17.14.4.4 A Brief Tutorial

This is a rather complex plug-in, so to help you understand it, we'll guide you through an example where you'll create a leaf or branch.

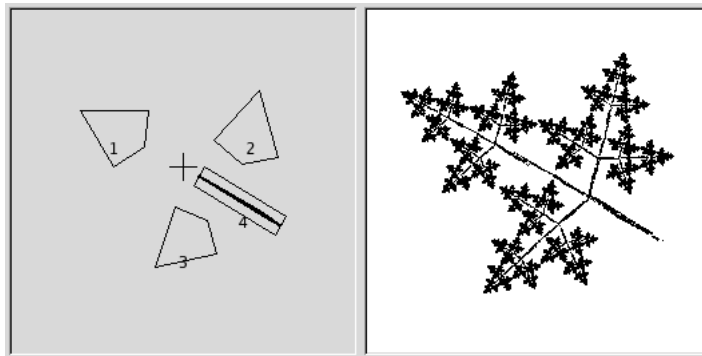
Many forms of life, and especially plants, are built like mathematical fractals, i.e., a shape that reproduces or repeats itself indefinitely into the smallest detail. You can easily reproduce the shape of a leaf or a branch by using four (or more) fractals. Three fractals make up the tip and sides of the leaf, and the fourth represents the stem.

1. Before invoking the filter: Select File → New Image. Add a transparent layer with Layers → Layers and Channels → New Layer. Set the foreground color in the toolbox to black, and set the background to white.
2. Open IFS Fractal. Start by rotating the right and bottom triangles, so that they point upward. You'll now be able to see the outline of what's going to be the tip and sides of the leaf. (If you have problems, it may help to know that the three vertices of a triangle are not equivalent.)

Figure 17.330 Tutorial Step 2

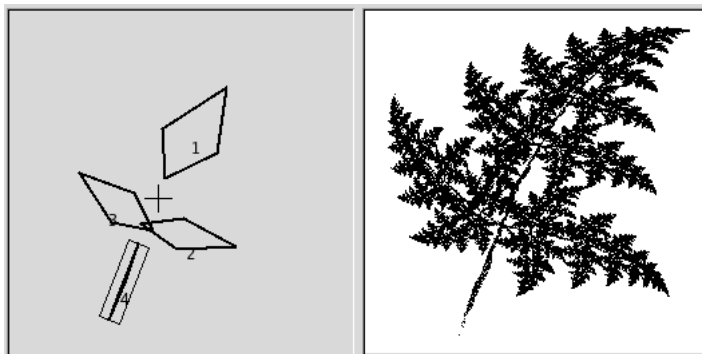
Start by rotating triangles 2 and 3, trying to keep them nearly the same size.

3. To make the leaf symmetrical, adjust the bottom triangle to point slightly to the left, and the right triangle to point slightly to the right.
4. Press New to add a component to the composition. This is going to be the stem of the leaf, so we need to make it long and thin. Press Stretch, and drag to stretch the new triangle. Don't be alarmed if this messes up the image, just use Scale to adjust the size of the overlong triangle. You'll probably also have to move and rotate the new fractal to make it look convincing.

Figure 17.331 Tutorial Step 3

Add a fourth component, then stretch, scale, and move it as shown.

5. You still have to make it look more leaf-like. Increase the size of the top triangle, until you think it's thick and leafy enough. Adjust all fractals until you're happy with the shape. Right-click to get the pop-up menu, and choose Select all. Now all components are selected, and you can scale and rotate the entire leaf.

Figure 17.332 Tutorial Step 4

Enlarge component 1, arrange the other components appropriately, then select all, scale and rotate.

6. The final step is to adjust color. Click on the Color Transformation tab, and choose a different color for each fractal. To do this, check Simple and press the right color square. A color circle appears, where you can click or select to choose a color.

Figure 17.333 Tutorial Step 5



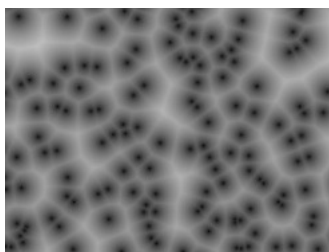
Assign a brownish color to component 4, and various shades of green to the other components.

7. Press OK to apply the image, and voilà, you've just made a perfect fractal leaf! Now that you've got the hang of it, you'll just have to experiment and make your own designs. All plant-imitating fractals (be they oak trees, ferns or straws) are more or less made in this fashion, which is leaves around a stem (or several stems). You just have to twist another way, stretch and turn a little or add a few more fractals to get a totally different plant.

17.14.5 Cell Noise

17.14.5.1 Overview

Generates a cellular texture. Results don't depend on the image you opened.



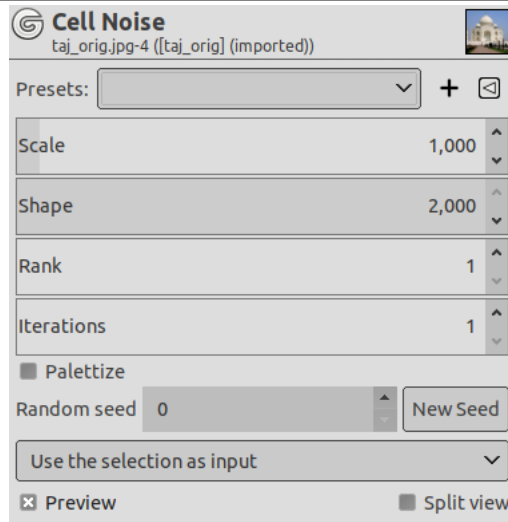
Filter applied with default options: scale=1.000 shape=2.000 rank=1

17.14.5.2 Activating the filter

This filter is found in the image window menu under Filters → Render → Noise → Cell Noise....


17.14.5.3 Options

Figure 17.334 “Cell Noise” filter options



Presets, Preview, Split view, Use selection as input

Note



These options are described in Section 17.2.

Scale Scale of the noise function: works like a zoom.

Shape Interpolates between Manhattan and Euclidean distance: (1.000 to 2.000). Lower values give four spikes stars nuclei to cells. Upper values give circular nuclei.

$$\text{Shape} = 1.000$$

Rank Selects the n-th closest point: (1-3). Cells are elongated.

$$\text{Rank} = 2$$

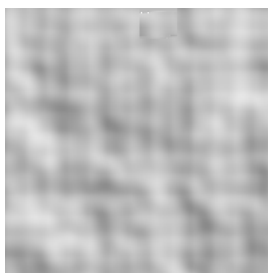
Iterations The number of noise octaves.

Palettize Fills each cell with a random color.

17.14.6 Perlin Noise

17.14.6.1 Overview

This filter generates a noise texture using the Perlin Noise algorithm. Results don't depend on the image you opened.



Filter applied with default options: Alpha=1.200 Scale=1.800 Z offset=-1.000 Iterations=3

17.14.6.2 Activating the filter

This filter is found in the image window menu under Filters → Render → Noise → Perlin Noise....


17.14.6.3 Options

Figure 17.335 “Perlin Noise” filter options



Presets, Preview, Split view, Use selection as input

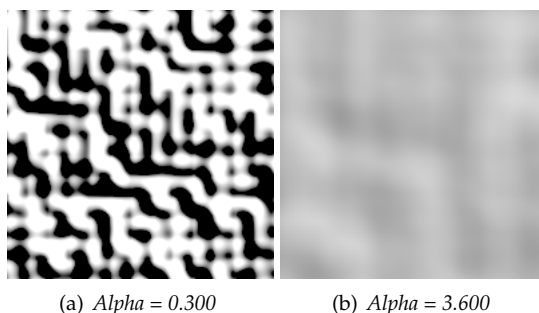
Note



These options are described in Section 17.2.

Alpha Low values give sharper noise

Figure 17.336 “Alpha ” option examples



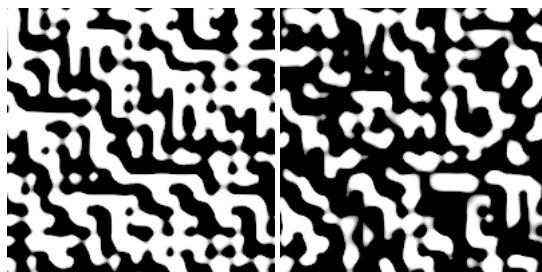
(a) Alpha = 0.300

(b) Alpha = 3.600

Scale Scale of the noise function: works like a zoom.

Z offset Vary noise.

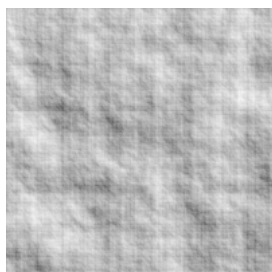
Figure 17.337 “Z offset” option examples



(a) *Z offset = -1000*

(b) *Z offset = 0.900*

Iterations The number of noise octaves.



Iterations = 7

17.14.7 Plasma

17.14.7.1 Overview

Figure 17.338 Example of a rendered plasma



Filter “Plasma” applied

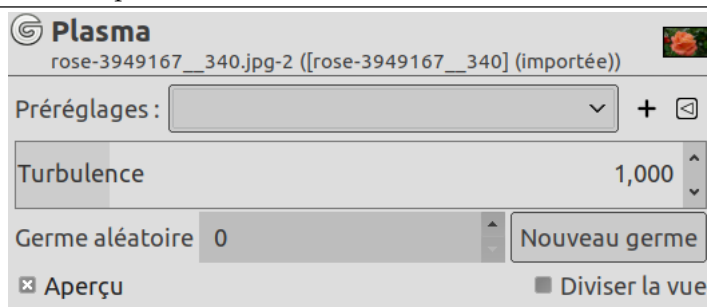
All of the colors produced by Plasma are completely saturated. Sometimes the strong colors may be distracting, and a more interesting surface will appear when you desaturate the image using Colors → Desaturate.

17.14.7.2 Activating the filter

This filter is found in the image window menu under Filters → Render → Clouds → Plasma....

17.14.7.3 Options

Figure 17.339 “Plasma” filter options



Preview If checked, parameter setting results are interactively displayed in preview.

Random seed This option controls the randomization element. The Randomize check-button will set the seed using the hardware clock of the computer. There is no reason to use anything else unless you want to be able to repeat the exact same pattern of randomization on a later occasion.

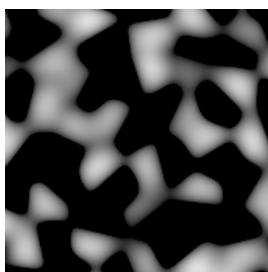
Turbulence This parameter controls the complexity of the plasma. High values give a hard feeling to the cloud (like an abstract oil painting or mineral grains), low values produce a softer cloud (like steam, mist or smoke). The range is 0.1 to 7.0.

Clipping The result of this filter can be larger than the original image. With the default Adjust option, the layer will be automatically resized as necessary when the filter is applied. With the Clip option the result will be clipped to the layer boundary.

17.14.8 Simplex Noise

17.14.8.1 Overview

This filter generates a noise texture using the Simplex Noise algorithm. Results don't depend on the image you opened



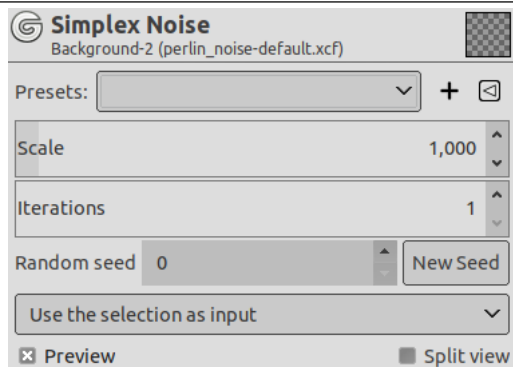
Filter applied with default options

17.14.8.2 Activating the filter

This filter is found in the image window menu under Filters → Render → Noise → Simplex Noise....

17.14.8.3 Options

Figure 17.340 “Simplex Noise” filter options



Presets, Preview, Split view, Use selection as input

Note



These options are described in Section [17.2](#).

Scale Scale of the noise function: works like a zoom.

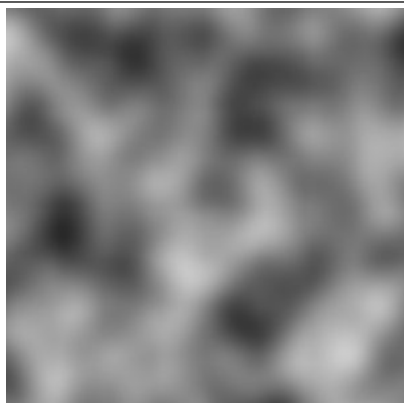
Iterations The number of noise octaves.

Random seed, New seed To vary noise.

17.14.9 Solid Noise

17.14.9.1 Overview

Figure 17.341 Example of turbulent solid noise



Filter “Solid noise” applied

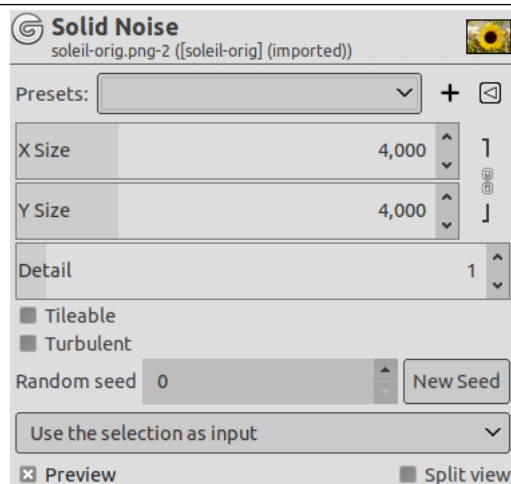
Solid Noise is a great texture maker. Note that this noise is always gray, even if you applied it to a very colorful image (it doesn’t matter what the original image looks like -- this filter completely overwrites any existing background in the layer it is applied to). This is also a good tool to create displacement maps for the [Warp transform](#) tool or for the [Bump Map](#) filter. With the “turbulence” setting active, the results look quite a bit like real clouds.

17.14.9.2 Activating the filter

This filter is found in the image window menu under Filters → Render → Clouds → Solid noise....

17.14.9.3 Options

Figure 17.342 “Solid Noise” filter options



Presets, Preview, Split view, Use selection as input

Note



These options are described in Section [17.2](#).

X size, Y size These control the size and proportion of the noise shapes in X (horizontal) and Y (vertical) directions (range 0.1 to 16.0).

Detail This controls the amount of detail in the noise texture. Higher values give a higher level of detail, and the noise seems to be made of spray or small particles, which makes it feel hard. A low value makes it more soft and cloudy.

Tileable If you check Tileable, you’ll get a noise which can be used as tiles. For example, you can use it as a background in an HTML page, and the tile edges will be joined seamlessly.

Turbulent If you check this, you’ll get very interesting effects, often something that looks much like oil on water, or clouds of smoke, or living tissue, or a Rorschach blot.

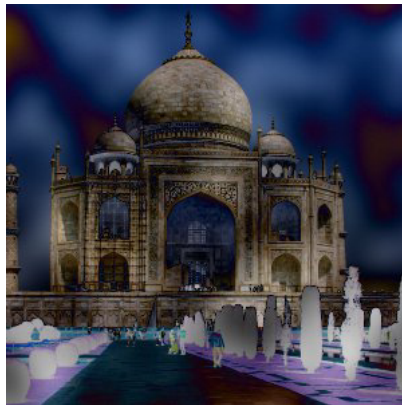
Random seed This option controls random behaviour of the filter. If the same random seed in the same situation is used, the filter produces exactly the same results. A different random seed produces different results. Random seed can be entered manually or generated randomly by pressing New Seed button.

When the Randomize option is checked, random seed cannot be entered manually, but is randomly generated each time the filter is run. If it is not checked, the filter remembers the last random seed used.

17.14.10 Difference Clouds

17.14.10.1 Overview

Figure 17.343 Example of Difference Clouds



Filter "Difference Clouds" applied

Difference Clouds command changes colors partially in cloud-like areas: The filter renders **Solid Noise** cloud in an automatically created new layer, and sets the layer mode to **Difference**, then merges this layer over the specified image.

If the image is in indexed colors, this menu entry is grayed out and unavailable.

17.14.10.2 Activate the filter

This filter is found in the image window menu under Filters → Render → Noise → Difference Clouds....

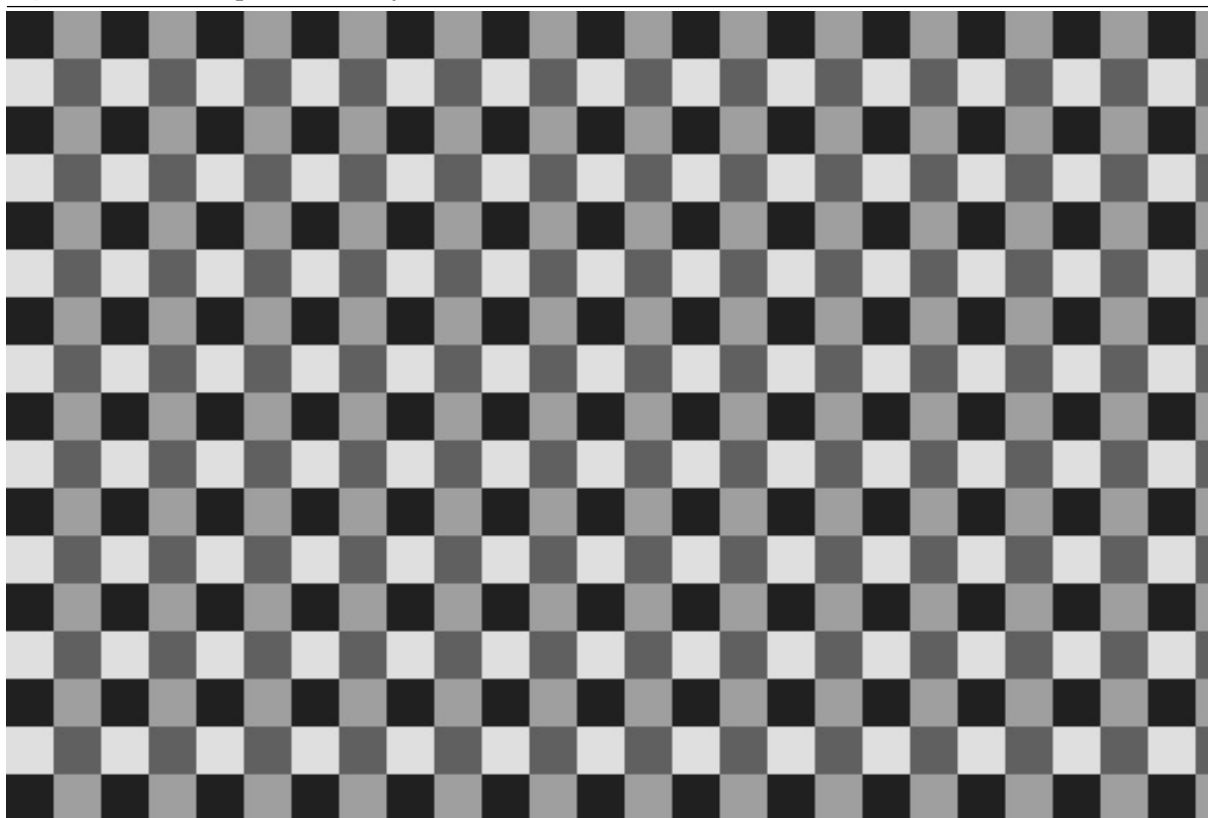
17.14.10.3 Options

This script has no option.

17.14.11 Bayer Matrix

17.14.11.1 Overview

Figure 17.344 Example for the Bayer Matrix filter



"Bayer Matrix" filter applied with Scale X, Y = 20

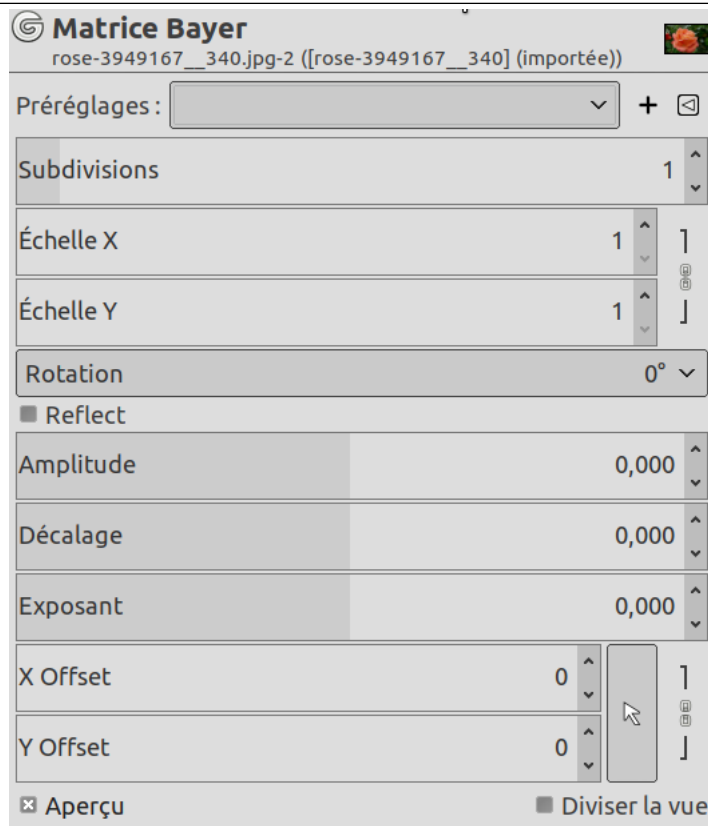
A grand-sounding name for a simple filter. Bayer matrix is related to *ordered dithering*, which is an image dithering algorithm used to display a continuous image on a display of smaller color depth. The algorithm reduces the number of colors by applying a threshold map known as Bayer matrix (Wikipedia). The present filter uses the Bayer matrix only to create a pattern.

17.14.11.2 Starting filter

You can find this filter in the image menu through Filters → Render → Pattern → Bayer Matrix...

17.14.11.3 Options

Figure 17.345 “Bayer Matrix” filter options



Presets, Preview, Split view

Note



These options are described in Section [17.2](#).

Subdivision TODO

X Scale, Y Scale Horizontal, Vertical pattern size.

Rotation TODO

Reflect Reflect the pattern horizontally.

Amplitude TODO

Offset TODO

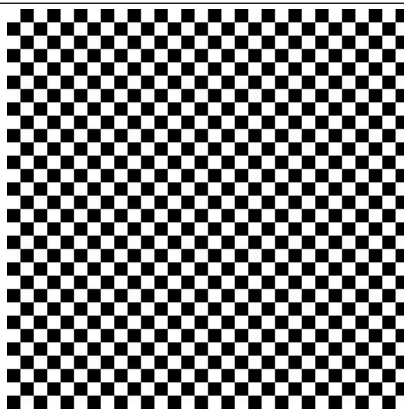
Exponent TODO

X, Y Offset TODO

17.14.12 Checkerboard

17.14.12.1 Overview

Figure 17.346 Example for the Checkerboard filter



Filter “Checkerboard” applied

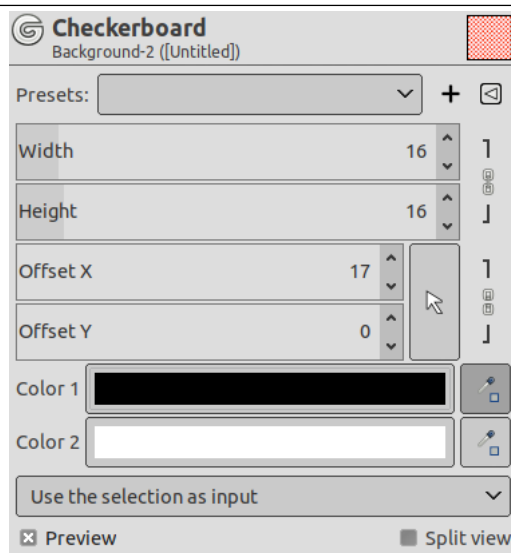
This filter creates a checkerboard pattern replacing the current layer content. Default colors used for pattern are current Fore- and Back-ground colors of toolbox.

17.14.12.2 Starting filter

You can find this filter in the image menu through Filters → Render → Pattern → Checkerboard...

17.14.12.3 Options

Figure 17.347 “Checkerboard (legacy)” filter options



Presets, Preview, Split view, Use selection as input

Note



These options are described in Section [17.2](#).

Width, Height With these options, you can set checkerboard horizontal/vertical square size, in pixels.

Increasing Width or Height only will create horizontal or vertical stripes.

Offset X, Offset Y These options displace squares horizontally (X) or vertically (Y). Value limits are the limits of your screen.

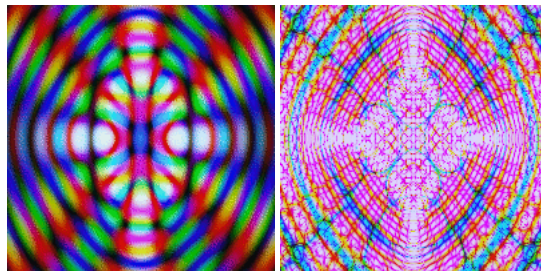
Color 1, Color 2 Default Color 1 is the toolbox foreground color. Default Color 2 is the toolbox background color.

You can change these colors clicking on the color dwell or using the color picker on the right. Color picker size can be set in the GEGL Operation window under Toolbox.

17.14.13 Diffraction Patterns

17.14.13.1 Overview

Figure 17.348 Two examples of diffraction patterns



This filter lets you make diffraction or wave interference textures. You can change the Frequency, Contours and Sharp Edges for each of the RGB channels. You can also set Brightness, Scattering and Polarization of the texture. There is no automatic preview, so you must press the preview button to update. On a slow system, this may take a bit of time. Note that result doesn't depend on the initial image.

This is a very useful filter if you want to create intricate patterns. It's perfect for making psychedelic, batik-like textures, or for imitating patterns in stained glass (as in a church window).

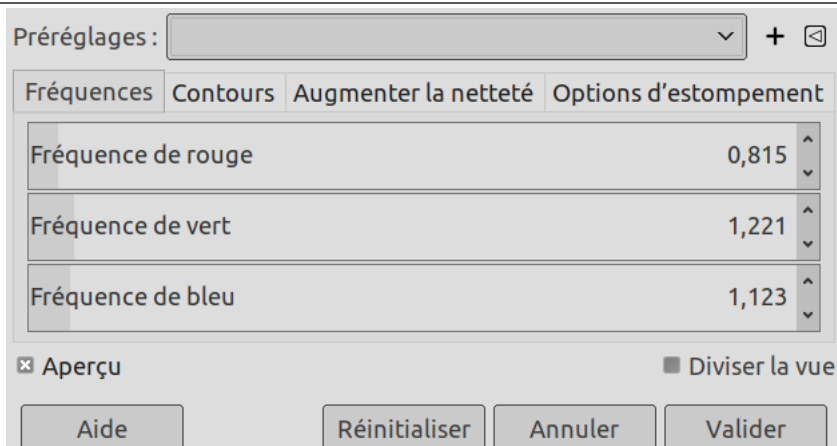
It seems clear that the plugin works by simulating the physics of light striking a grating. Unfortunately, the original authors never got around to writing down the theory behind it, or explaining what the parameters mean. The best approach, then, is just to twiddle things and see what happens. Fortunately, almost anything you do seems to produce interesting results.

17.14.13.2 Activating the filter

This filter is found in the image window menu under Filters → Render → Pattern → Diffraction Patterns....

17.14.13.3 Options

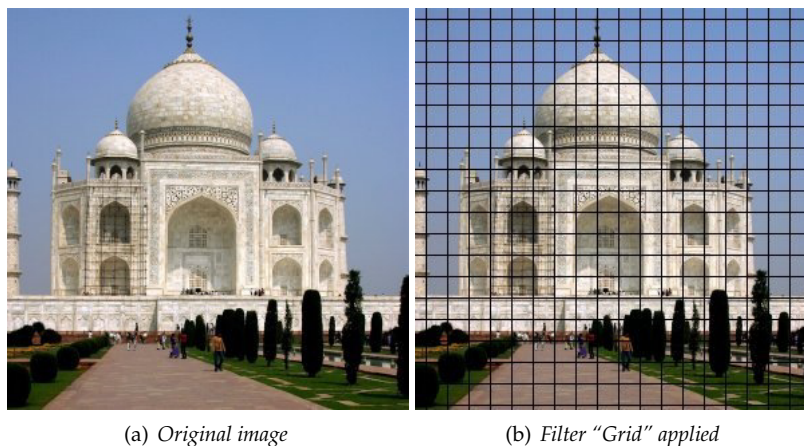
Figure 17.349 “Diffraction Patterns” filter options



17.14.14 Grid

17.14.14.1 Overview

Figure 17.350 Applying example for the Grid filter



It renders a Cartesian grid in the active layer, on top of the existing contents. The width, line width, offsets, and colors of the grid lines can all be set by the user. By default, the lines are with the GIMP’s foreground color.

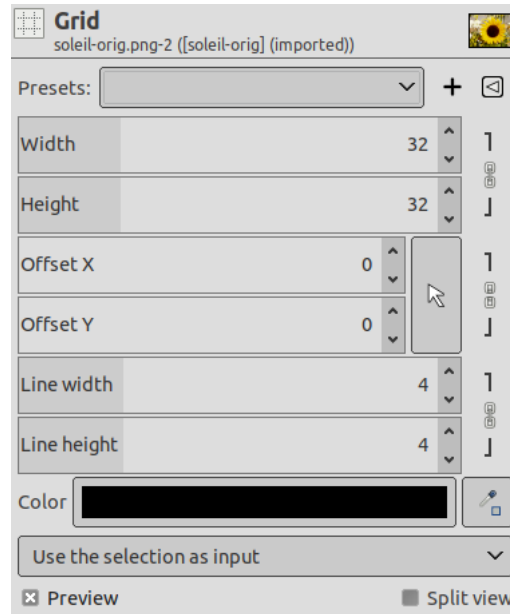
This filter is more simple than the Section [17.14.19](#) legacy filter.

17.14.14.2 Activating the filter

This filter is found in the image window menu under Filters → Render → Pattern → Grid...

17.14.14.3 Options

Figure 17.351 “Grid” filter options



By default, the horizontal and vertical settings are locked together, so that all changes are applied symmetrically. If you want to change just one of them, click on the “chain” symbol below it to unlock them.

Besides, for some options, you can select the unit of measurement thanks to a drop-down list.

Presets, Preview, Split view, Use selection as input**Note**

These options are described in Section [17.2](#).

Width, Height These are width and height of boxes determined by the grid.

Offset Sets the offset for grid lines with respect to the upper left corner.

Line width, Line height This is thickness of the grid.

Color Default Color is the toolbox foreground color.

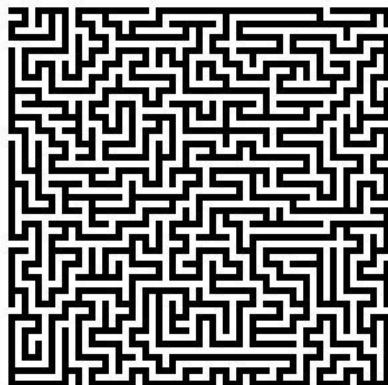
You can change these colors clicking on the color dwell or using the color picker on the right. Color picker size can be set in the GEGl Operation window under Toolbox.

See also Section [12.2](#).

17.14.15 Maze

17.14.15.1 Overview

Figure 17.352 An example of a rendered maze.



Filter "Maze" applied

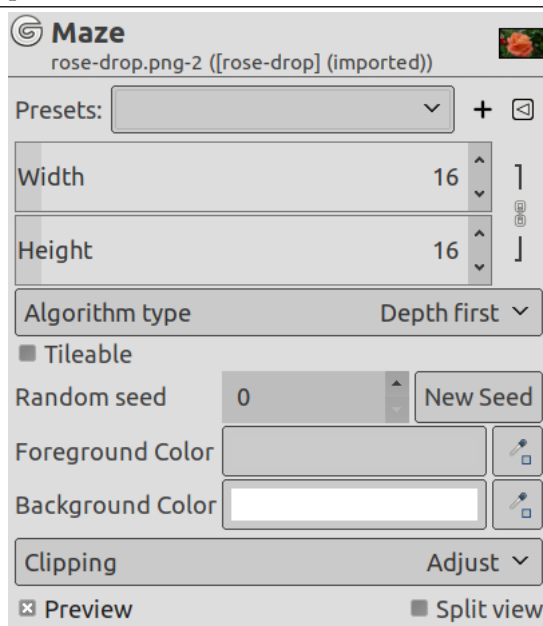
This filter generates a random black and white maze pattern. The result completely overwrites the previous contents of the active layer. A typical example is shown below. Can you find the route from the center to the edge?

17.14.15.2 Activating the filter

This filter is found in the image window menu under Filters → Render → Pattern → Maze...

17.14.15.3 Options

Figure 17.353 "Maze" filter options



Presets, Preview, Split view, Use selection as input

Note

These options are described in Section [17.2](#).

Width, Height These sliders control how many pathways the maze should have. The lower the values for width and height, the more paths you will get. The same happens if you increase the number of pieces in the Width and Height Pieces fields. The result won't really look like a maze unless the width and height are equal.

Algorithm type You can choose between these two algorithms for maze: *Depth first* and *Prim's algorithm*. Only a computer scientist can tell the difference between them.

Tileable If you want to use it in a pattern, you can make the maze tileable by checking this check-button.

Seed You can specify a seed for the random number generator, or ask the program to generate one for you. Unless you need to later reproduce exactly the same maze, you might as well have the program do it.

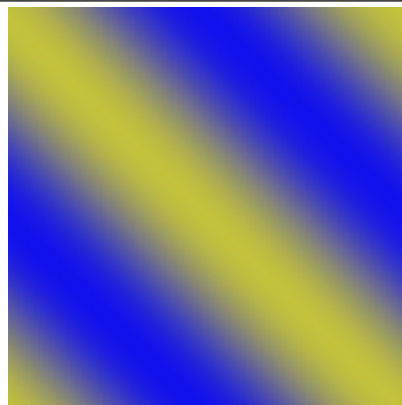
Foreground color, Background color You can choose colors for the maze and its background. Defaults are Toolbox colors.

Clipping The result of this filter can be larger than the original image. With the default Adjust option, the layer will be automatically resized as necessary when the filter is applied. With the Clip option the result will be clipped to the layer boundary.

17.14.16 Sinus

17.14.16.1 Overview

Figure 17.354 Applying example for the Sinus filter



Filter "Sinus" applied

You can find this filter from the image menu through Filters → Render → Pattern → Sinus....

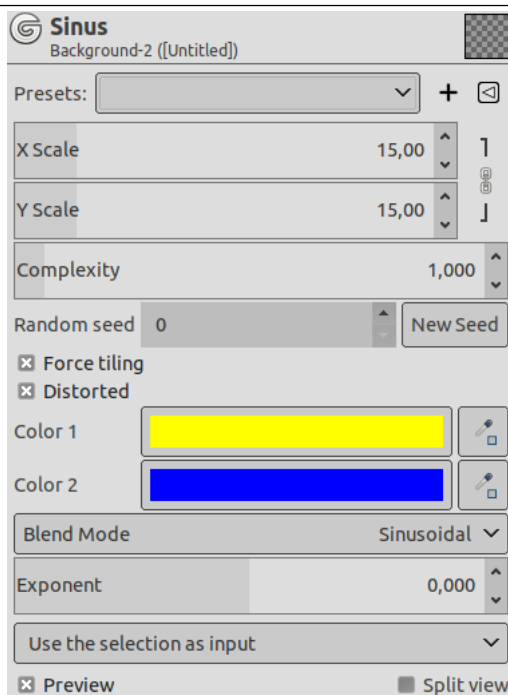
The Sinus filter lets you make sinusoidally based textures, which look rather like watered silk or maybe plywood. This plug-in works by using two different colors that you can define in the Colors tab. These two colors then create wave patterns based on a sine function.

You can set the X and Y scales, which determine how stretched or packed the texture will be. You can also set the Complexity of the function: a high value creates more interference or repetition in the pattern. An example is shown below.

Results don't depend on the image you opened.

17.14.16.2 Options

Figure 17.355 “Sinus” filter options (Settings)



X scale, Y scale A low X/Y value will maximize the horizontal/vertical stretch of the texture, whereas a high value will compress it.

Complexity This controls how the two colors interact with each other (the amount of interplay or repetition).

Random seed This option controls the random behavior of the filter. If the same random seed in the same situation is used, the filter produces exactly the same results. A different random seed produces different results. Random seed can be entered manually or generated randomly by pressing the New Seed button.

When the Randomize option is checked, random seed cannot be entered manually, but is randomly generated each time the filter is run. If it is not checked, the filter remembers the last random seed used.

Force tiling If you check this, you’ll get a pattern that can be used for tiling. For example, you can use it as a background in an HTML page, and the tile edges will be joined seamlessly.

Distorted This options give additional control of the interaction between the two colors.

Color 1, Color 2 Here, you set the two colors that make up your texture. Default colors are yellow and blue.

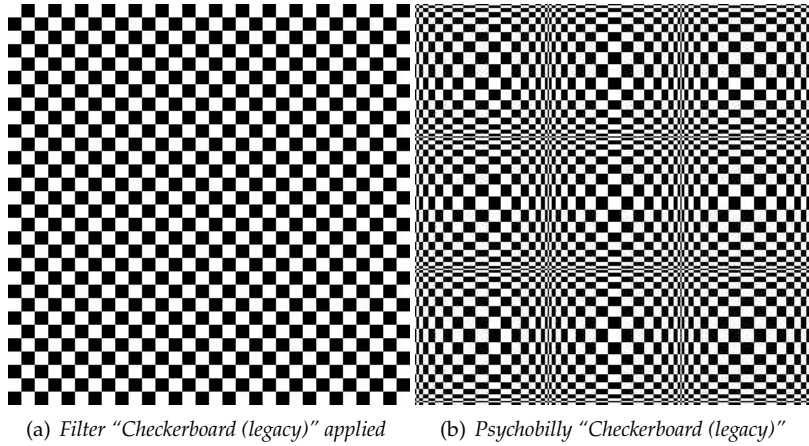
Blend Mode You can choose between three functions to set the shapes of the waves that are produced: Linear, Bilinear and Sinusoidal.

Exponent The Exponent controls which of the two colors is dominant, and how dominant it is. If you set the exponent to -7.5, the left color will dominate totally, and if you set it to +7.5 it will be the other way around. A zero value is neutral.

17.14.17 Checkerboard (legacy)

17.14.17.1 Overview

Figure 17.356 Example for the Checkerboard (legacy) filter



This filter creates a checkerboard pattern replacing the current layer content. Colors used for pattern are current Fore- and Back ground colors of toolbox.

17.14.17.2 Starting filter

You can find this filter in the image menu through Filters → Render → Pattern → Checkerboard (legacy)...

17.14.17.3 Options

Figure 17.357 "Checkerboard (legacy)" filter options



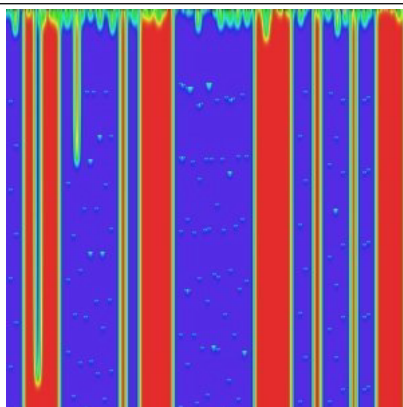
Size With this option, you can set checkerboard square size, in pixels, or in your chosen unit by using the drop-down list.

Psychobilly This option gives an eiderdown look to the Checkerboard.

17.14.18 CML Explorer

17.14.18.1 Overview

Figure 17.358 Example for the “CML Explorer” filter



Filter “CML Explorer” applied with default options

This filter is the king of texture creating filters. It is extremely efficient but very complex. It uses a mathematical method named Cellular Automata [WKPD-CA].

17.14.18.2 Activating the filter

You can find this filter from the image menu through Filters → Render → Pattern → CML Explorer....

17.14.18.3 Options

17.14.18.3.1 General Options

Filter options are distributed among Hue, Saturation, Value, Advanced, Others and Misc tabs. Some more options are available. They will be described in following section.

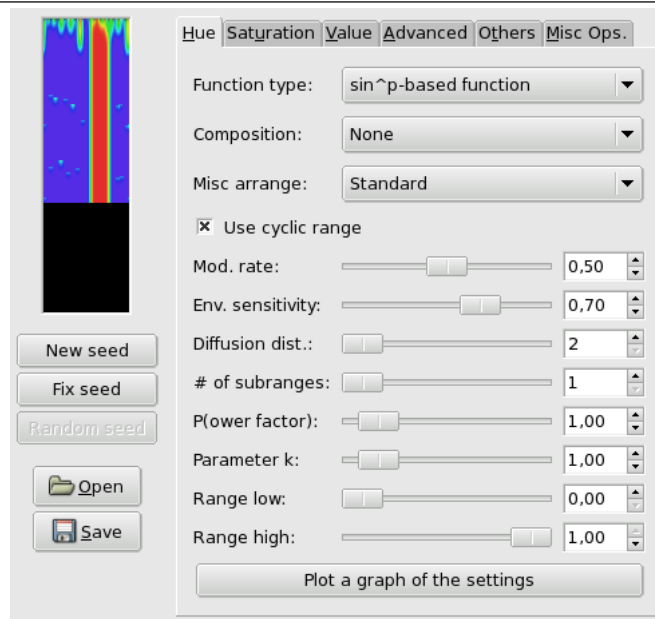
Preview This filter offers you a Preview where you can see the result of your settings before they are applied to the image.

New Seed, Fix Seed, Random Seed Random plays a large part in creating patterns. With these options, you can influence the way random is generated. By clicking on the New Seed button, you can force random to use a new source of random. The preview will show you the result. Fix Seed lets you keep the same seed and so to reproduce the same effect with the filter. Random Seed generates a random seed at random.

Open, Save With these both command buttons you can save pattern settings in a file, and to get them back later.

17.14.18.3.2 “CML Explorer” filter options (Hue)

Figure 17.359 Hue tab



This filter works in the **HSV** color model. In this tab, you can set options for Hue.

Function type In this drop-down list, you can select the method that will be used to treat the current layer. These methods are:

Keep image’s values With this option, image hue values will be kept.

Keep the first value With this option, starting color will be standard cyan.

Fill with parameter k Pattern look will depend on k that you will set later in options.

Miscellaneous $f(k)$ See above, “Fill with k parameter”.

Delta function, Delta function stepped // TODO

\sin^p -based function, \sin^p , stepped These options create wave-like patterns, like aurora borealis or curtain folds.

Composition Here, these options concern Hue. You can choose among several functions, and a book could be filled with results of all these functions. Please, experiment!

Misc. arrange This drop-down list offers you several other parameters. Also a book would be necessary to explain all possibilities of these parameters.

Use cyclic range // TODO

Mod. rate With this slider and the input box, you can set modification rate from 0.0 to 1.0. Low value results in a lined pattern.

Env. sensitivity Value is from 0.0 to 1.0

Diffusion dist. Diffusion distance: from 2 to 10.

of subranges Number of sub-rangers: from 1 to 10.

(P)ower factor With this option you can influence the Function types using the p parameter. Value from 0.0 to 10.0.

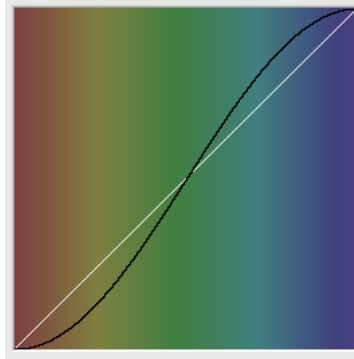
Parameter k With this option you can influence the Function types using the k parameter. Value from 0.0 to 10.0.

Range low Set lower limit of hue that will be used for calculation. values vary from 0.0 to 1.0.

Range high Set the upper limit of hue that will be used for calculation. Variations are from 0.0 to 1.0.

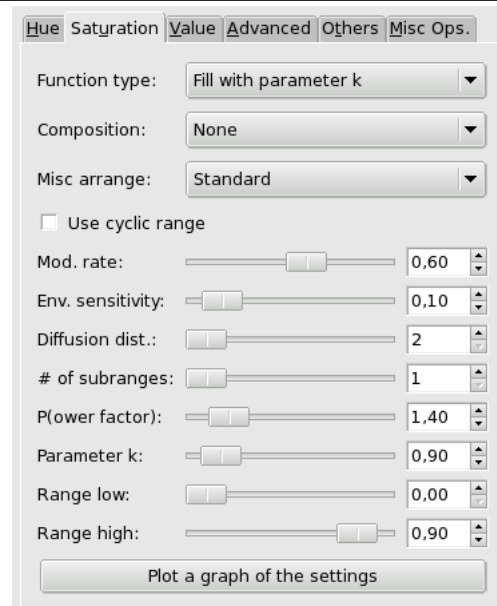
Plot a Graph of the Settings By clicking on this large button, you can open a window that displays the graph of hue present settings.

Figure 17.360 Function graph of present settings



17.14.18.3.3 “CML Explorer” filter options (Saturation)

Figure 17.361 Saturation tab

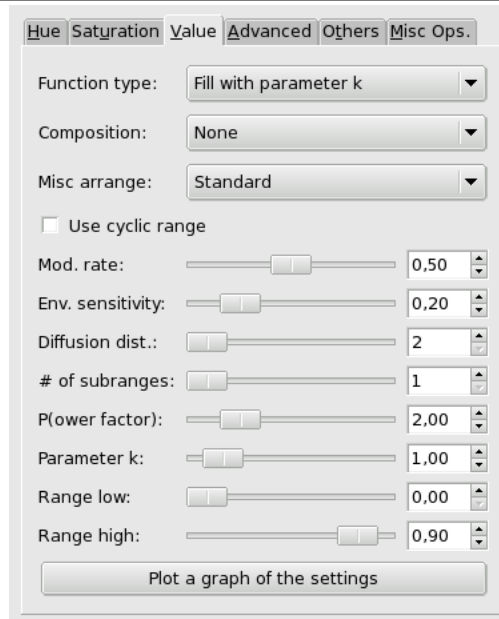


In this tab, you can set how Saturation component of the HSV color model will be used in pattern calculation.

These options are similar to Hue tab options.

17.14.18.3.4 “CML Explorer” filter options (Value)

Figure 17.362 Value tab

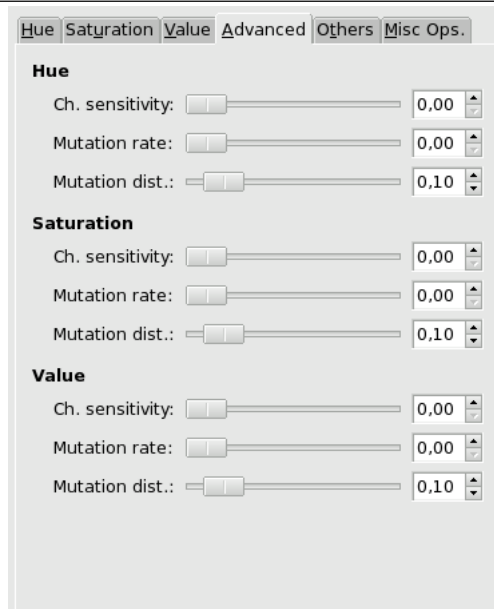


In this tab, you can set how the Value (Luminosity) component of the HSV color model will be used in pattern calculation.

These options are similar to Hue tab options.

17.14.18.3.5 “CML Explorer” filter options (Advanced)

Figure 17.363 Advanced tab



These tab settings apply to the three HSV channels.

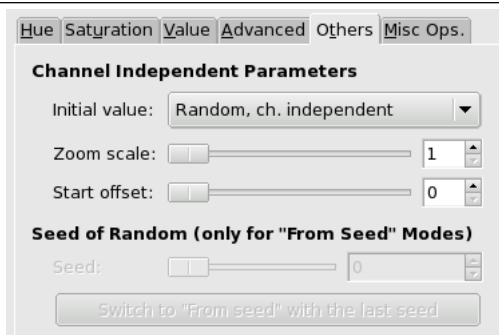
Channel sensitivity // TODO

Mutation rate // TODO

Mutation distance // TODO

17.14.18.3.6 “CML Explorer” filter options (Others)

Figure 17.364 Others tab



In this tab, you can find various parameters about image display and random intervention.

Initial value // TODO

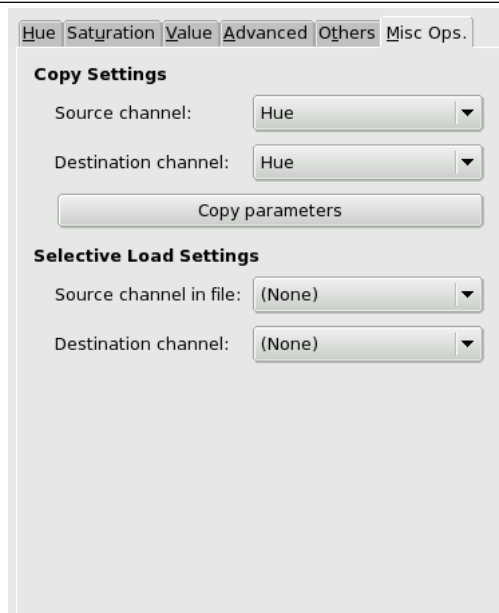
Zoom scale // TODO

Start offset // TODO

Seed of Random // TODO

17.14.18.3.7 “CML Explorer” filter options (Misc)

Figure 17.365 Miscellaneous options tab



In this tab you can find various options about copy and loading.

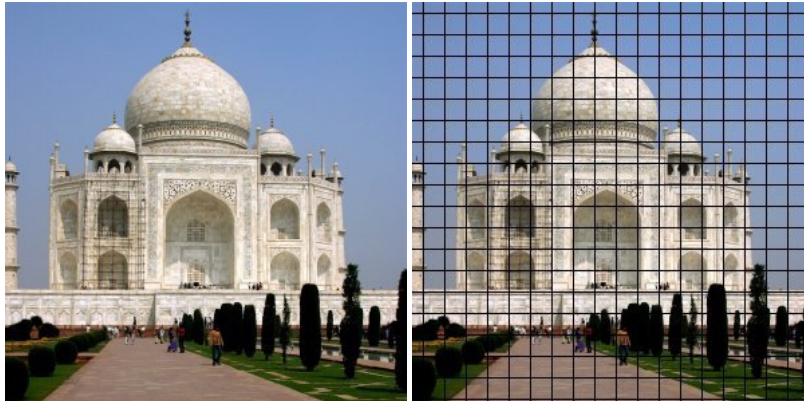
Copy Settings These options allow you to transfer information from one of the HSV channel to another one.

Selective Load Settings With the Open button of this filter, you can load previously loaded settings. If you don't want to load all of them, you can select a source and a destination channel here.

17.14.19 Grid (legacy)

17.14.19.1 Overview

Figure 17.366 Applying example for the Grid (legacy) filter



(a) Original image

(b) Filter “Grid (legacy)” applied

It renders a Cartesian grid in the active layer, on top of the existing contents. The width, spacing, offsets, and colors of the grid lines can all be set by the user. By default, the lines are with the GIMP’s foreground color. (Note: this plug-in was used to create demonstration images for many of the other plug-ins.)

Tip



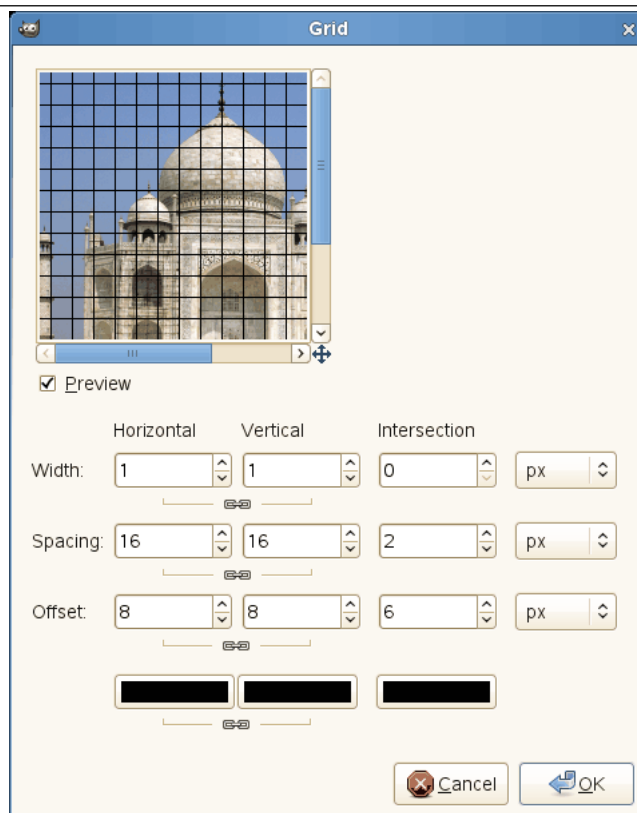
If you set the grid line widths to 0, then only the intersections will be drawn, as plus-marks.

17.14.19.2 Activating the filter

This filter is found in the image window menu under Filters → Render → Pattern → Grid (legacy)...

17.14.19.3 Options

Figure 17.367 “Grid (legacy)” filter options



There are separate options for controlling the horizontal grid lines, vertical grid lines, and intersections. By default, the horizontal and vertical settings are locked together, so that all changes are applied symmetrically. If you want to change just one of them, click on the “chain” symbol below it to unlock them. The results of changing the Intersection parameters are rather complex.

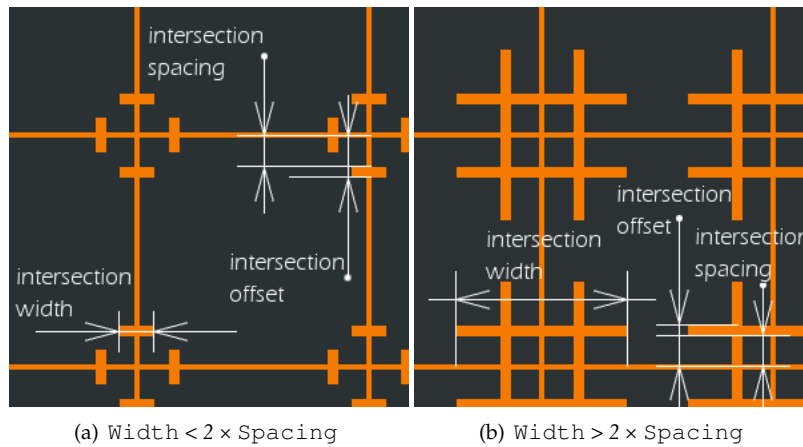
Besides, for some options, you can select the unit of measurement thanks to a drop-down list.

Width Sets the widths of the horizontal or vertical grid lines, or of the symbols drawn at their intersections.

Spacing Sets the distance between grid lines. The Intersection parameter clears the space between the intersection point and the end of the arms of the intersection crosses.

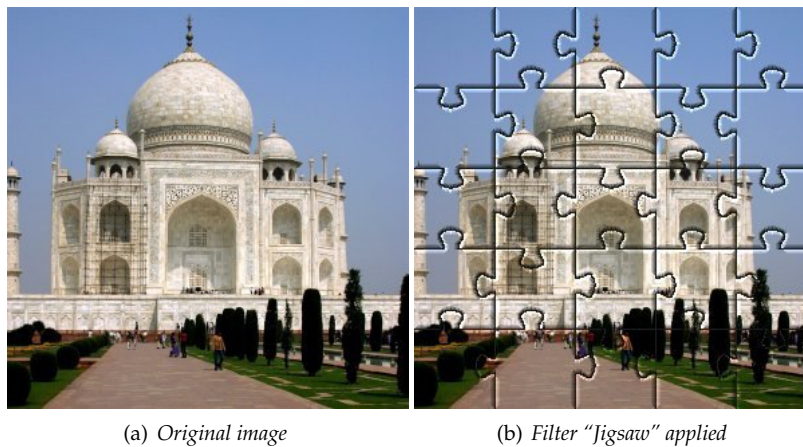
Offset Sets the offset for grid lines with respect to the upper left corner. For intersections, sets the length of the arms of the intersection crosses.

Color Selectors These allow you to set the colors of the grid lines and intersection marks.

Figure 17.368 Intersection parameters

17.14.20 Jigsaw

17.14.20.1 Overview

Figure 17.369 Jigsaw filter example

This filter will turn your image into a jigsaw puzzle. The edges are not anti-aliased, so a little bit of smoothing often makes them look better (i. e., Gaussian blur with radius 1.0).

Tip



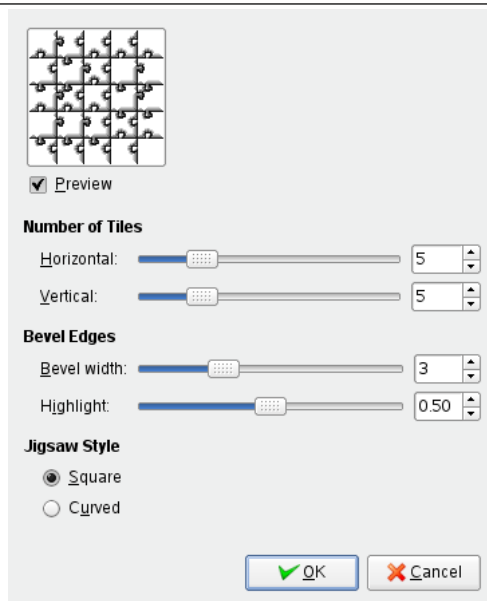
If you want to be able to easily select individual puzzle-piece areas, render the jigsaw pattern on a separate layer filled with solid white, and set the layer mode to Multiply. You can then select puzzle pieces using the **magic wand** (fuzzy select) tool on the new jigsaw layer.

17.14.20.2 Activating the filter

This filter is found in the image window menu under Filters → Render → Pattern → Jigsaw....

17.14.20.3 Options

Figure 17.370 “Jigsaw” filter options



Number of Tiles How many tiles across the image is, horizontally and vertically.

Bevel Edges

Bevel width The Bevel width slider controls the slope of the edges of the puzzle pieces (a hard wooden puzzle would require a low Bevel width value, and a soft cardboard puzzle would require a higher value).

Highlight The Highlight slider controls the strength of the highlight that will appear on the edges of each piece. You may compare it to the “glossiness” of the material the puzzle is made of. Highlight width is relative to the Bevel width. As a rule of thumb, the more pieces you add to the puzzle, the lower Bevel and Highlight values you should use, and vice versa. The default values are suitable for a 500x500 pixel image.

Jigsaw Style

You can choose between two types of puzzle:

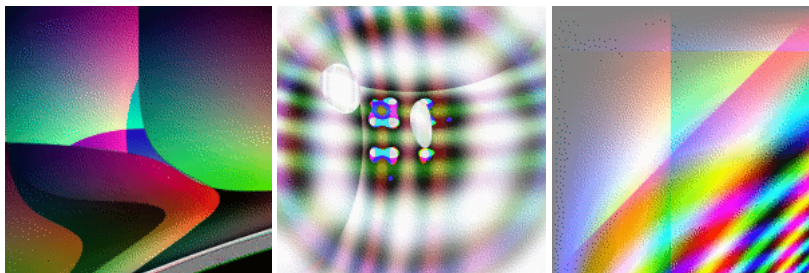
Square Then you get pieces made with straight lines.

Curved Then you get pieces made with curves.

17.14.21 Qbist

17.14.21.1 Overview

Figure 17.371 Applying examples for the Qbist filter



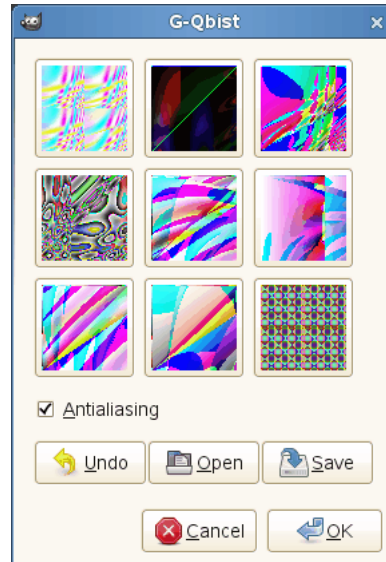
The Qbist filter generates random textures containing geometric figures and color gradients.

17.14.21.2 Activating the filter

This filter is found in the image window menu under Filters → Render → Pattern → Qbist...

17.14.21.3 Options

Figure 17.372 “Qbist” filter options



The Qbist filter generates random textures. A starting texture is displayed in the middle square, and different variations surround it. If you like one of the alternative textures, click on it. The chosen texture now turns up in the middle, and variations on that specific theme are displayed around it. When you have found the texture you want, click on it and then click OK. The texture will now appear on the currently active layer, completely replacing its previous contents.

Antialiasing If you check this, it will make edges appear smooth rather than stair-step-like.

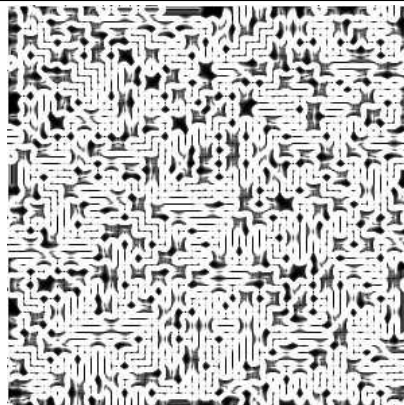
Undo Lets you go back one step in history.

Open, Save These buttons allow you to save and reload your textures. This is quite handy because it's almost impossible to re-create a good pattern by just clicking around.

17.14.22 Circuit

17.14.22.1 Overview

Figure 17.373 Example of Circuit



Filter “Circuit” applied.

Circuit command is a script that fills the selected region (or alpha) with traces like those on the back of an old circuit board. It looks even better when gradmapped with a suitable gradient.

Tip



The effect seems to work best on odd shaped selections because of some limitations in the maze codes selection handling ability.

If the image is in indexed colors, this menu entry is grayed out and unavailable.

Note



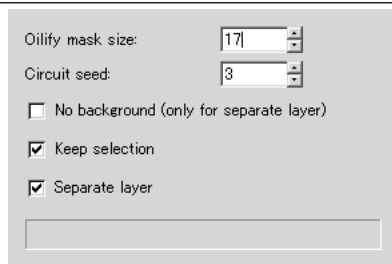
This filter creates a grey level image in RGB mode.
The resulting image doesn't depend on the original image.

17.14.22.2 Activate the filter

This filter is found in the image window menu under Filters → Render → Circuit....

17.14.22.3 Options

Figure 17.374 “Circuit” filter options



Oilify mask size With this option you can set the option value of the **Oilify** filter in pixels (range 3 to 50). Larger values make lines more fuzzy. 17 is the default value.

Circuit seed You can give a randomizing seed number between 1 and 3000000. The default value is 3.

No background (only for separate layer) If this option is enabled, dark pixels of the circuit are made transparent so that the underlying image is shown through these holes. This option is disabled in default settings. The Separate layer option is required.

Keep selection If an active selection exists when this script is called, you can keep the selection and its marching ants with this option. This option is enabled in default settings.

Separate layer If this option is not checked, the generated texture is drawn on the active layer. When this option is enabled (in default), this script adds a layer to draw the circuit texture is on.

17.14.22.4 Making the Circuit effect

The Circuit effect is achieved through the following steps:

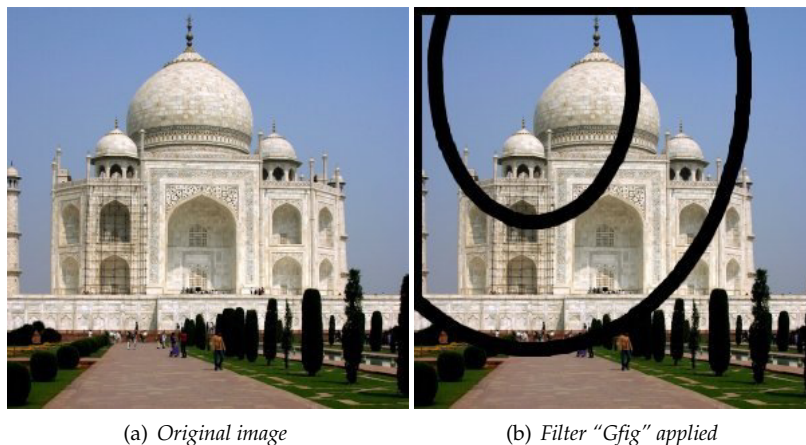
1. First, **draw maze** with 5 pixels width pathways and walls with the “Depth First” algorithm. The pattern of maze is set by Circuit seed.

2. **Oilify** this maze with a brush of Oilify mask size.
3. Then apply the **extract edge** filter with Sobel algorithm, Smear option and Amount to 2.0, to the oilified maze image. This crowds high contrast winding curves like as a circuit map.
4. Finally, **Desaturate** the map with gray color in RGB mode.

17.14.23 Gfig

17.14.23.1 Overview

Figure 17.375 The same image, before and after using Gfig



This filter is a tool: You can create geometrical figures to add them to the image. It is very complex. I hope this paper will help you.

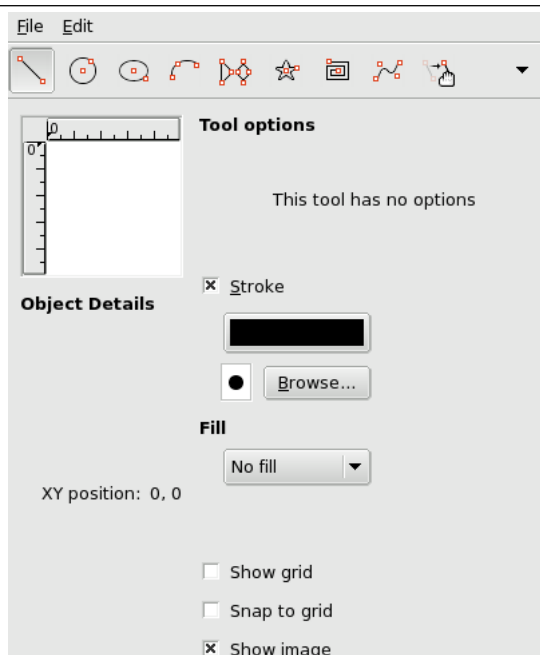
When using this filter, elements inserted in the image will be placed in a new layer. So the image will not be modified, all modifications occurring in this layer.

17.14.23.2 Starting filter

You can find this filter through Filters → Render → Gfig...

17.14.23.3 Options

Figure 17.376 “Gfig” filter options



The Preview (with a horizontal and a vertical ruler) on the left of the main window actually is your working area where you are adding your figures.

You can add and modify figures using the Gfig tools ([Gfig tool bar](#)) and using the appropriate options ([Gfig main window](#)).

17.14.23.3.1 The Gfig tool bar

At the top of dialog, you can find a set of icons which represents the functions of this filter. Help pop-ups are explicit.

Functions for object drawing

On the left part of tool bar, you can find some functions for object drawing. You enable them by clicking on the corresponding icon. You can create the following objects (note that *Control points* are created at the same time as object):

Create line With this tool, you can draw lines. Click on Preview to mark start point, then drag mouse pointer to the end point.

Create rectangle With this tool, you can draw rectangles. Click on Preview to mark start point, then drag mouse pointer to create the rectangle.

Create circle With this tool, you can draw circles. Click on Preview to mark center, then drag mouse pointer to the wanted radius.

Create ellipse With this tool, you can draw ellipses. Click on Preview to mark center, then drag mouse pointer to get the wanted size and form.

Create arc With this tool, you can draw circle arcs. Click on Preview to set start point. Click again to set another arc point. Without releasing mouse button, drag pointer; when you release mouse button, the arc end point is placed and an arc encompassing these three points is drawn.

Create regular polygon With this tool, you can create a regular polygon. Start with setting side number in Tool Options at the right of Preview. Then click on Preview to place center and, without releasing mouse button, drag pointer to get the wanted size and orientation.

Create star With this tool, you can create a star. Start with setting side number (spikes) in Tool Options at the right of Preview. Then click on Preview to place center and, without releasing mouse button, drag pointer to get the wanted size and orientation.

Create spiral With this tool, you can create a spiral. Start with setting spire number (sides) and spire orientation in Tool Options at the right of Preview. Then click on Preview to place center and, without releasing mouse button, drag pointer to get the wanted size.

Create bezier curve With this tool, you can create Bézier curves. Click on Preview to set start point and the other points: the curve will be created between these points. To end point creation press **Shift** key when creating last point.

Functions for object management

In the middle of tool bar, you can find tools to manage objects:

Move an object With this tool, you can move the active object. To enable an object, click on a control point created at the same time as the object.

Move a single point With this tool, you can click-and-drag one of the control points created at the same time as object. Each of these points moves the object in a different way.

Copy an object With this tool, you can duplicate an object. Click on an object control point and drag it to the wanted place.

Delete an object Click on an object control point to delete it.

Select an object With this tool, you can select an object to active it. Simply click on one of its control points.

Functions for object organisation

At the right of tool bar, you can find tools for object superimposing (you can also get them by clicking on the drop-down list button if they are not visible). You have:

Up (Raise selected object), Down (Lower selected object) With this tool, you can push the selected object one level up or down.

Top, Bottom Self explanatory.

Functions for object display

Back, Forward These functions allow you to jump from one object to another. Only this object is displayed.

Show all objects This function shows all objects again, after using both previous functions.

Note



If your window is too small to show all icons, the tool bar provides a drop-down list which offers you the missing functions.

17.14.23.3.2 The Gfig main window

Object Details The XY position shows the position of your pointer.

Tool Options If the selected tool provides some options (like number of sides), you can change them here.

Stroke If this option is checked, the object will be drawn. Two buttons are available, to select color and brush type. Changes to color or brush apply to existing objects too.

Fill With help of this drop-down list, you can decide whether and how the object will be filled, with a color, a pattern or a gradient.

Show grid If this option is checked, a grid is applied on Preview to make object positioning easier.

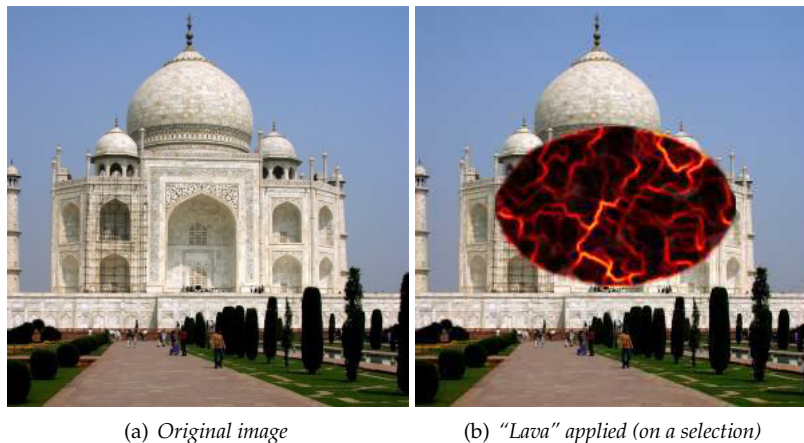
Snap to grid If this option is checked, objects will align to the grid.

Show image When this option is checked, the current image is displayed in Preview (working area).

17.14.24 Lava

17.14.24.1 Overview

Figure 17.377 Example for the “Lava” filter

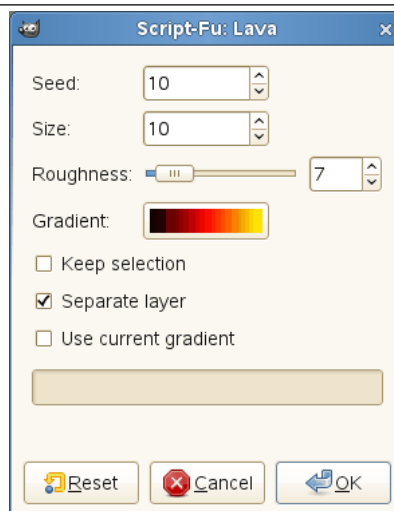


17.14.24.2 Activating the filter

This filter is found in the image window menu under Filters → Render → Lava....

17.14.24.3 Options

Figure 17.378 “Lava” options



Seed TODO

Size TODO

Roughness TODO

Gradient TODO

Keep selection TODO

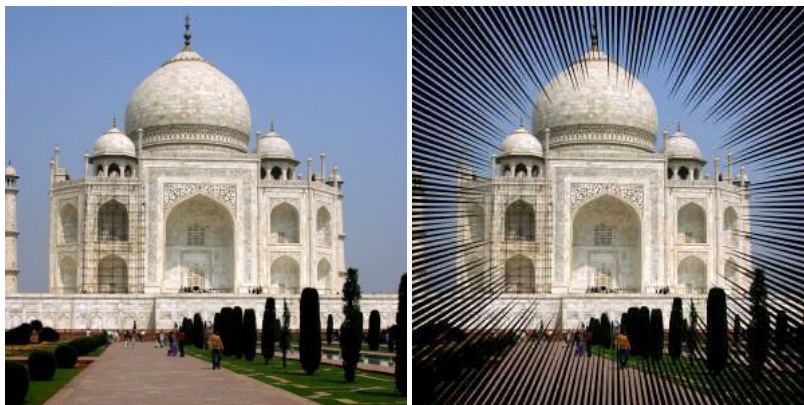
Separate layer TODO

Use current gradient TODO

17.14.25 Line Nova

17.14.25.1 Overview

Figure 17.379 Example for the “Line Nova” filter



(a) Original image

(b) “Line Nova” applied

The Line Nova filter fills a layer with rays emanating outward from the center of the layer using the foreground color shown in the Toolbox. The rays starts as one pixel and grew broader towards the edges of the layer.

Tip



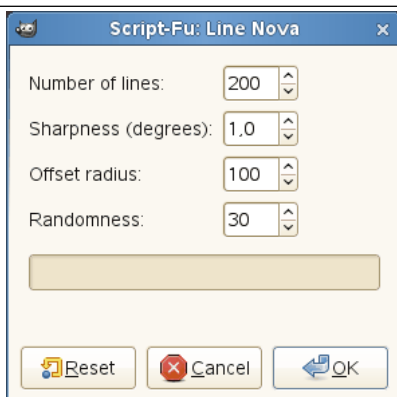
This filter does not provide any option which allows you to set the center point of lines. If you need adjust the place of the radial lines where you want, create another transparent image and apply this filter on it, then add it on your image. Setting large size for the new nova image may help you not to break lines inside of your image.

17.14.25.2 Activating the filter

This filter is found in the image window menu under Filters → Render → Line Nova...

17.14.25.3 Options

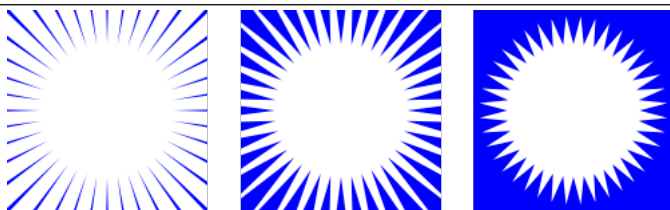
Figure 17.380 “Line Nova” options



Number of lines By using this option you can set the number of lines between 40 to 1000. The default is 200.

Sharpness (degrees) This slider determines how much the rays will broaden towards the edges. The range goes from 0.0 to 10.0. If set to 0.0, nothing will be drawn. If set to 10.0, most of the area near the edges of the layer will be painted.

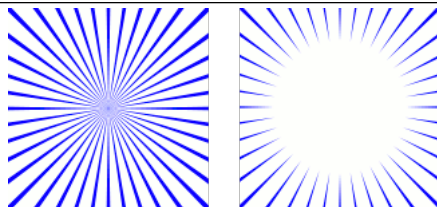
Figure 17.381 “Line Nova” sharpness option



From left to right: sharpness = 1; sharpness = 5; sharpness = 10

Offset radius Here you choose the distance, in pixels, from center to the starting point of the rays. If set to 0.0 the rays start from the center. Any other value will let the starting points be on a circle at the selected distance from the center. The maximum distance is 2000 pixels. The default value is 100 pixels.

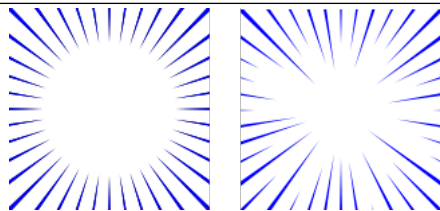
Figure 17.382 “Line Nova” offset radius option



From left to right: offset radius = 0; offset radius = 50

Randomness If this slider is set to a value higher than 1, the starting point for each ray differ more or less randomly from the average starting point set as the offset radius above. With the value set to 1, all the rays will start at the circle determined by the offset radius. The maximum value is 2000. The default value is 30.

Figure 17.383 “Line Nova” randomness option

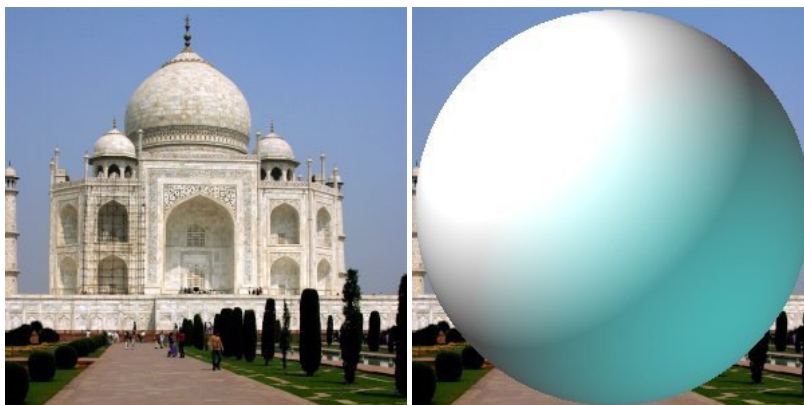


From left to right: randomness = 1; randomness = 50

17.14.26 Sphere Designer

17.14.26.1 Overview

Figure 17.384 The same image, before and after the application of “Sphere Designer” filter.



(a) Original image

(b) Filter “Sphere Designer” applied

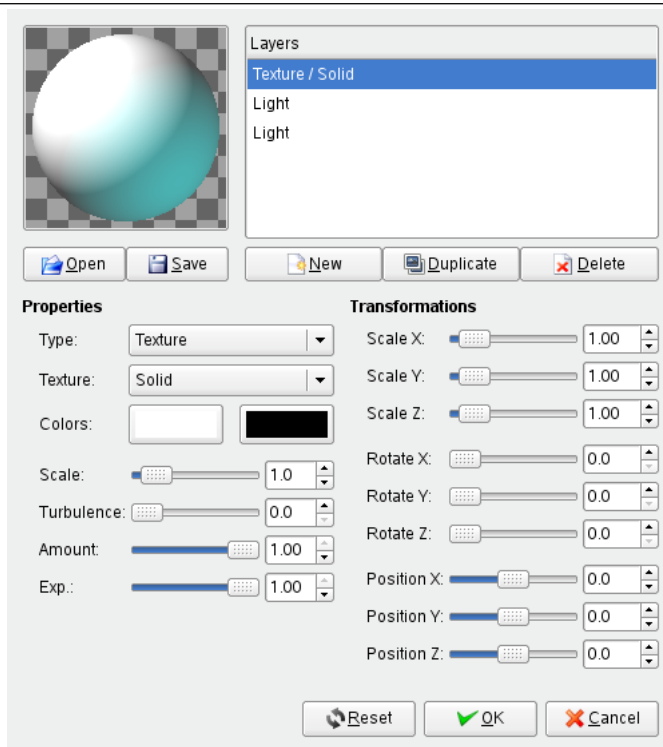
This filter creates a three dimensional sphere with different textures. It replaces the original image.

17.14.26.2 Activating Sphere Designer

You can find this filter through Filters → Render → Sphere Designer....

17.14.26.3 Options

Figure 17.385 “Sphere Designer” filter parameters



Preview All your setting changes will appear in the Preview without affecting the image until you click on OK. Note that the preview displays the whole image, even if the final result will concern a selection. Click the button *Update Preview* to see the result of the current settings.

Textures

The list of textures applied to the sphere. These textures are applied in the order listed. Each item shows the type and the name of the texture.

New Creates a new texture and adds it to the end of the list. The name and the features of this new texture are the ones which are displayed in the Texture Properties area, but you can change them by operating in this area, provided that your new texture is highlighted.

Duplicate Copies the selected texture and adds the copy to the end of the list.

Delete Deletes the selected texture from the list.

Open, Save Allows to save current settings or load previously saved settings.

Properties

Type Determines the type of action on the sphere.

Texture Covers the sphere with a specific pattern.

Bumpmap Gives some relief to the texture.

Light Lets you set the parameters of the light shining on the sphere.

Texture Determines the pattern used by the texture type. If the texture applies to light then the light is distorted by this texture as if it was going through this texture before falling onto the sphere. If the texture applies to the texture itself, the texture is applied directly to the sphere. Several options are available.

Colors Sets the two colors to be used for a texture. By pressing the color button a color selection dialog appears.

Scale Determines the size of separate elements composing the texture. For example, for the “Checker” texture this parameter determines the size of black and white squares. Value range is from 0 to 10.

Turbulence Determines the degree of texture distortion before applying the texture to the sphere. Value range is from 0 to 10. With values of up to 1.0 you can still make out the undistorted patterns; beyond that the texture gradually turns into noise.

Amount Determines the degree of influence the texture has on the final result. Value range is from 0 to 1. With the value of 0 the texture does not affect the result.

Exponent With the Wood texture, this options gives an aspect of venetian blind, more or less open.

Transformations

Scale X, Scale Y, Scale Z Determines the degree of stretching/compression of the texture on the sphere along the three directions. The value range is from 0 to 10.

Rotate X, Rotate Y, Rotate Z Determines the amount of a turn of the texture on the sphere around the three axes. The value range is from 0 to 360.

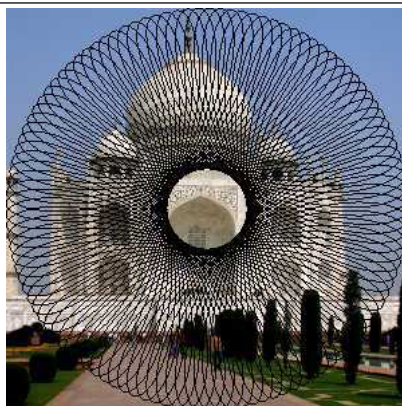
Position X, Position Y, Position Z Determines the position of the texture relative to the sphere. When type is Light, this parameter refers to the position of the light floodlighting the sphere.

The Reset button sets all parameters to the default values.

17.14.27 Spyrogimp

17.14.27.1 Overview

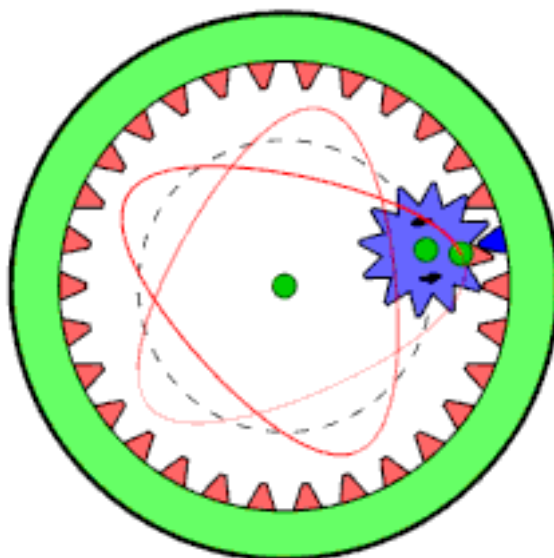
Figure 17.386 Example for the “Spyrogimp” filter



“Spyrogimp” applied

This filter draws Spirographs, Epitrochoids, and Lissajous curves. Immediate feedback is provided, by drawing to a temporary layer.

It reproduces curves drawn by Spirograph© toys. Here is an example from Wikipedia showing what gears and holes are:



Moving gear is inside fixed gear and only one hole is used.

17.14.27.2 Activating the filter

This filter is found in the image window menu under Filters → Render → Spyrogimp....

17.14.27.3 Selection and Tool

Much of the behavior of the plugin is determined by options set outside of the plugin, such as the current selection, or settings for gimp tools. These settings can be changed while the plugin is running.

Note



In contrast to options within the plugin, changing the current selection or tool settings will not redraw the pattern. To draw the change, click the Redraw button at the bottom of the plugin.

17.14.27.3.1 The Current Selection

As in most plugins, the current selection determines the area where the pattern will be rendered. Typically, this would be a rectangular selection. There is however, an additional way the selection can be used.

The selection can be used as the shape of the fixed gear (under the Fixed Gear tab). The plugin will attempt to extract shapes from the selection, and draw a pattern inside of each shape. This is more interesting if you select a non-rectangular selection.

To have the pattern hug the boundaries of the shapes, use hole percent=100.

17.14.27.3.2 Tool Settings

Spyrogimp uses gimp tools to perform the drawing. All the settings with which the drawings are done are taken from the chosen tool. For example, if you choose to use the Pencil tool (by choosing it from the Tool menu) then all the settings of the Gimp Pencil tool will be used for drawing. You can change any of the tool settings while the plugin is running, and press the Redraw button to see how the pattern looks.

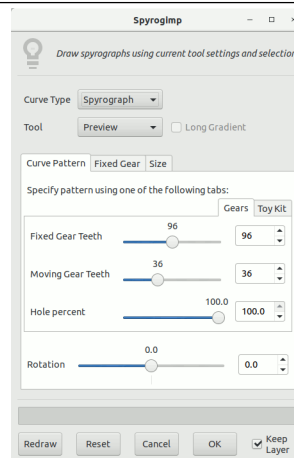
17.14.27.3.3 Gradient Settings

When using the long gradient mode, some settings from the gradient tool are used.

17.14.27.4 Options

Most of the options are organized under three tabs: Curve Pattern, Fixed Gear, and Size.

Figure 17.387 “Spyrogimp” options



Note



This filter has been totally reimplemented since gimp 2.10.10 . If you are using an older version of gimp, your dialog will look different.

17.14.27.4.1 Options Above the Tabs

Curve Type The available curve types are: Spyrograph, Epitrochoid, Sine, and Lissajous. These correspond to physical models for drawing them, using either gears or springs. Spyrograph and Epitrochoid curves are obtained by using two gears - a fixed gear, and a moving gear. A Spyrograph pattern is obtained when the moving gear is rotated inside the fixed gear. When the moving gear is outside the fixed gear, an Epitrochoid pattern is generated. The Sine curve uses the fixed gear, but instead of a moving gear, there is a spring that moves perpendicular to the fixed gear's edge. The Lissajous curve is generated by two springs - that move on the x and y axis - it does not use the fixed ring at all, and thus is not affected by changing it.

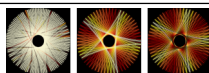
Figure 17.388 “Spyrogimp” Curve Types



Curve types from left to right: Spyrograph, Epitrochoid, Sine and Lissajous.

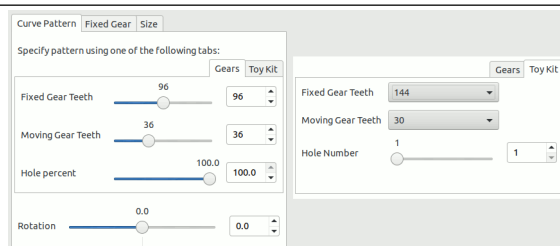
Tool The gimp tool with which to draw the pattern. The first tool is named Preview and its purpose is to draw quickly, rather than beautifully - so the pattern can be previewed. The other available tools are: PaintBrush, Pencil, AirBrush, Stroke, Ink, and MyPaintBrush.

Long Gradient When unchecked, the current tool settings will be used - this can either produce a gradient or not, depending on the tool settings. When checked, the plugin will produce a long gradient to match the length of the pattern, based on the current gradient, the “Reverse” setting, and the Repeat mode from the gradient tool settings. Setting the Repeat mode to Triangle Wave will produce a pattern that changes continuously, with no abrupt breaks. This is done by using the gradient followed by its reverse. Any other Repeat mode will simply use the gradient from start to finish.

Figure 17.389 “Spyrogimp” Long Gradient Examples

The left image, without Long Gradient, used the paintbrush tool with a gradient. The two right images were generated with the same gradient, but with Long Gradient checked. The right image used the Triangle Wave Repeat mode.

17.14.27.4.2 Curve Pattern Tab

Figure 17.390 “Spyrogimp” filter options (Curve Pattern)

The inner Toy Kit tab is shown on the right.

Specify pattern using either the Gears or Toy Kit tabs. The pattern is specified only by the active tab. Toy Kit is similar to Gears, but it uses gears and hole numbers which are found in toy kits. If you follow the instructions from the toy kit manuals, you should obtain similar results.

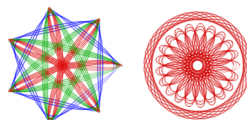
Fixed Gear Teeth Number of teeth of fixed gear. The size of the fixed gear is proportional to the number of teeth.

Moving Gear Teeth Number of teeth of moving gear. The size of the moving gear is proportional to the number of teeth.

Hole percent How far is the hole from the center of the moving gear. 100% means that the hole is at the gear’s edge.

The Toy Kit tab also has Fixed Gear Teeth and Moving Gear Teeth options, however, these are menus which limited to gear sizes that are provided with toy kits for drawing Spyrographs.

Hole Number Hole #1 is at the edge of the gear. The maximum hole number is near the center. The maximum hole number is different for each gear.

Figure 17.391 “Spyrogimp” Toy Kit Examples

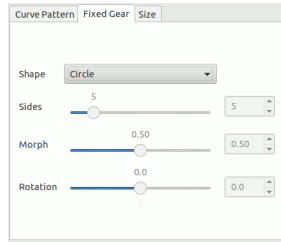
The Toy Kit helps recreate designs from the toy kit. The left image uses a 105 fixed gear, and a 30 (blue), 45 (green) and 60 (red) moving gears, where each moving gear was used several times with Hole Number varying from 3 to 7. The right image also uses the 105 fixed ring, with moving ring 24 (Hole Number 4), and moving ring 80 (Hole numbers 16, 18, 20).

Below the tabs there is an additional option.

Rotation Rotation of the pattern, in degrees. The starting position of the moving gear in the fixed gear. Note that this also changes the pattern when drawing Lissajous curves.

17.14.27.4.3 Fixed Gear Tab

Figure 17.392 “Spyrogimp” filter options (Fixed Gear)



Shape The shape of the fixed gear to be used inside current selection.

- Circle
- Rack is a long round-edged shape provided in the toy kits.
- Frame hugs the boundaries of the rectangular selection, use hole=100 in Gear notation to touch boundary. To generate a narrow frame width, use a small number of teeth for the moving gear.
- Selection will hug boundaries of current selection - try something non-rectangular.
- Polygon-Star morphs from an n-sided polygon (morph=0) to an n-sided star (morph=0.3) to a crazy flower (morph=1).
- Sine with morph=0, it is just like a circle, but becomes more wavy as morph increases.
- Bumps morphs from a polygon (morph=0) to a scalloped circle.

Figure 17.393 “Spyrogimp” Shape Examples



From left to right, Circle, Rack, Frame, and Selection shapes of the fixed gear. The selection in the right image was generated by selecting a large letter “T” that was produced by the text tool.

Figure 17.394 “Spyrogimp” Polygon-Star Shape Examples



From left to right, Morph = 0, 0.3, 0.6, 1

Figure 17.395 “Spyrogimp” Sine Shape Examples



From left to right, Morph = 0.1, 0.3, 0.5

Figure 17.396 “Spyrogimp” Bumps Shape Examples



From left to right, Morph = 0, 0.5, 1

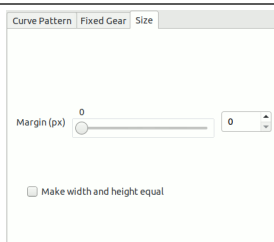
Sides Number of sides of the shape. This applies only to the Polygon-Star, Sine, and Bumps shapes. Otherwise this option is disabled.

Morph Morph fixed gear shape. This applies only to the Polygon-Star, Sine, and Bumps shapes. Otherwise this option is disabled

Rotation Rotation of the fixed gear, in degrees.

17.14.27.4.4 Size Tab

Figure 17.397 “Spyrogimp” filter options (Size)



Margin (px) Margin from the edge of selection. This controls the size of the pattern.

Make width and height equal When unchecked, the pattern will fill the current image or selection. When checked, the pattern will have same width and height, and will be centered. The difference between checked and unchecked will only be noticed if the size of the width and height of the selection differ.

17.14.27.4.5 Buttons Below the Tabs

Redraw If you change the settings of a tool, change color, or change the selection (i.e., any settings outside of the plugin that effect the pattern), press this to preview how the pattern looks.

Reset Resets the dialog to its default options.

Cancel Delete the temporary layer, and exit the plugin.

OK Render pattern to image. If Keep Layer is unchecked, this might take some extra time to complete, as the pattern needs to be redrawn on the active layer.

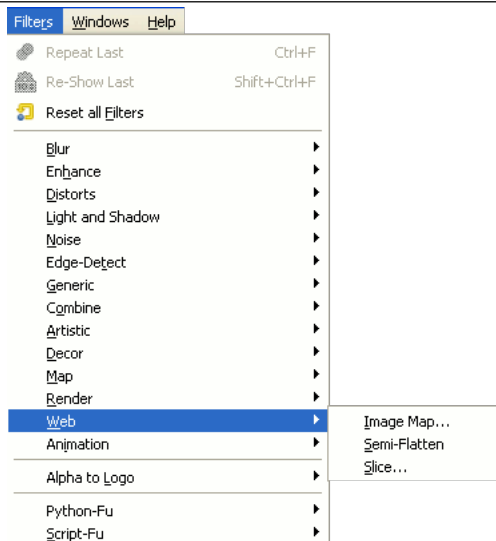
Keep Layer Determines what will happen to the temporary layer once OK is pressed. If checked, then once OK is pressed, the temporary layer is kept, and the plugin exits quickly. If unchecked, the layer is deleted, and the pattern is redrawn on the active layer.

One reason to not keep the layer, is that by using specific paint application modes, redrawing the pattern on the active layer can interact with it in interesting ways, that produce a different pattern had it been drawn on a new layer.

17.15 Web Filters

17.15.1 Introduction

Figure 17.398 The Web filters menu



These filters are mostly used on images mentioned for web sites. The filter **ImageMap** is used to add clickable “hot spots” on the image. The filter **Semi-Flatten** is used to simulate semi-transparency in image formats without alpha channel. The **Slice** filter creates HTML tables of sensitive images.

17.15.2 ImageMap

In Web sensitive images are frequently used to get some effects when defined areas are enabled by the pointer. Obviously the most used effect is a dynamic link to another web page when one of the sensitive areas is clicked on. This “filter” allows you to design easily sensitive areas within an image. Applications for website design have this as a standard function. In GIMP, you can do this in a similar way.

17.15.2.1 Overview

This plug-in lets you design graphically and friendly all areas you want to delimit over your displayed image. You get the relevant part of html tags that must be merged into the right place in your page html code. You can define some actions linked to these areas too.

This is a complex tool which is not completely described here (it works about like Web page makers offering this function). However we want to describe here some of the most current handlings. If you want, you can find a more complete descriptions in [Grokking the GIMP](#) with the link [[GROKING02](#)].

17.15.2.2 Activate the filter

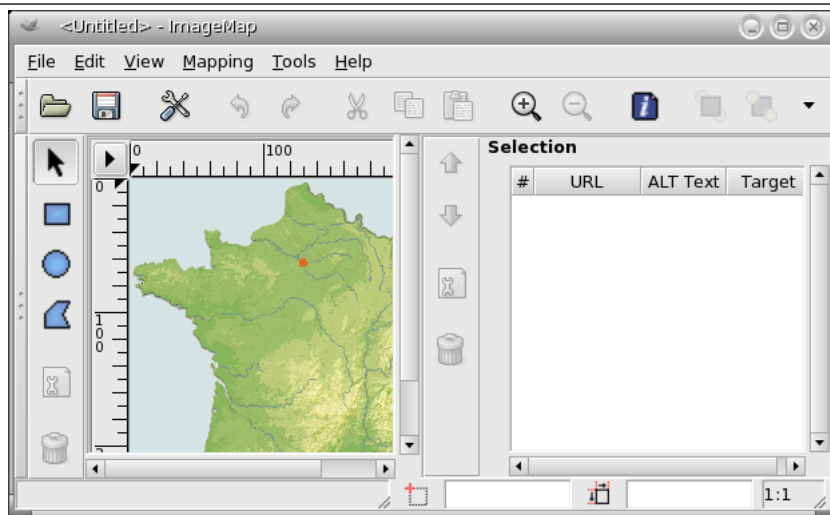
From an image window, you can find this filter through Filters → Web → ImageMap...

The window is a small one, but you can magnify it. The main useful areas are:

- completely on the left are vertically displayed icons, one for pointing, three for calling tools to generate various shape areas, one to edit zone properties, and finally one to erase a selected zone; you can call these functions with the Mapping menu,
- just on the right is your working area where you can draw all the shapes areas you want with the relevant tools,
- on the right is displayed an icon vertical set; its use is obvious but a help pop-up gives you some information about each function,
- finally, even on the right is a display area, as a property list of the created areas. A click on one item of the list selects automatically the corresponding shape in the working area,

17.15.2.3 Options

Figure 17.399 Imagemap filter options



Imagemap window

17.15.2.3.1 The Menu Bar

The menu bar is similar to the image window menu bar, only a few menus or menu entries are different:

File

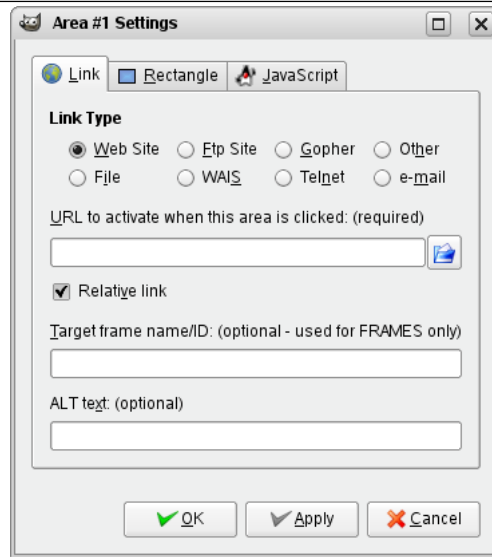
Save; Save As Contrary to other filters, this plug-in doesn't make an image but a text file. So you must save your work in a text format.

Tip

With View → Source you can preview this text file content.

Open; Open recent In the plug-in you can open the saved text file. The areas defined in your file will be loaded and overdisplayed; if the displayed image is not the original one or not with the same size, GIMP will ask you for adapting the scale.

Edit**Edit area info**

Figure 17.400 Editing an imagemap area

In the settings dialog you can edit the area information of a selected area. This dialog will pop up automatically whenever you create a new area.

View This menu offers you special functions:

Area list Here you can hide or show the selection area.

Source Here you see the raw data as you would save it to or read it from a file.

Color; Grayscale You can select the image mode here and work with a Grayscale display.

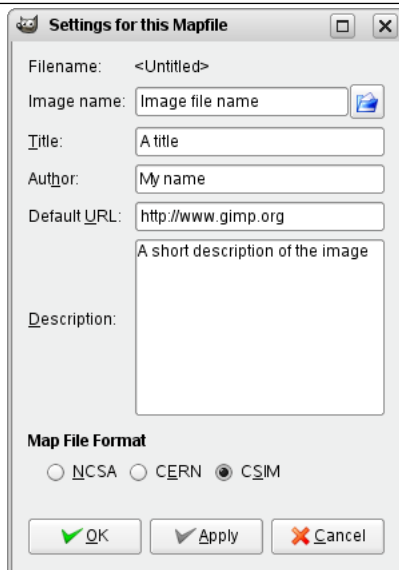
Mapping You will seldom use this menu, since you can more easily access selection tools by clicking on icons on the left of the working area.

Arrow The arrow here represents the Move tool. When activated tool is selected, you can select and move an area on the image.

With a polygon, you can use the arrow to move one of the red points. Right-click on a segment between two red points to open a pop-up menu that offers, with several others, the possibility to add a new point. If you right-click on a red point, you can remove it.

Rectangle; Circle; Polygon These tools let you create various shape areas: click on the image, move the pointer, and click again.

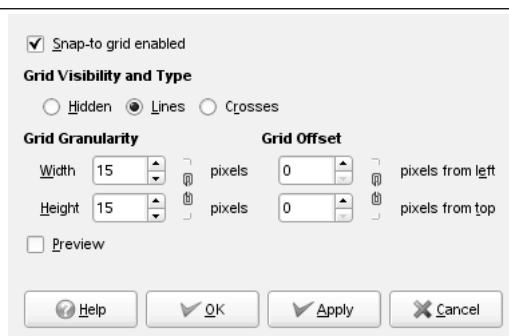
Edit Map Info

Figure 17.401 Editing the imagemap data

With this simple dialog you can enter some items, which will be written to the resulting output file; either as comments (Author, Description) or as attribute values of the HTML tags (Image name, Title, Default URL).

Tools With the “Tools” menu you can create guides and even regularly spaced rectangular areas.

Grid; Grid settings

Figure 17.402 Grid options

Here you can enable and disable the image grid or configure some grid properties.

Use GIMP guides; Create guides The guide lines are created at the border of the image but can be moved around by clicking on the red squares on each line something similar to the GIMP guide lines. By using the guides you are able to create active rectangles in the image.

Create guides

Figure 17.403 Guide options

Image dimensions: 148 × 156
 Resulting Guide Bounds: 0,0 to 0,0 (0 areas)

Width: 64 Left start at: 15
 Height: 38 Top start at: 10
 Horz. spacing: 0 No. across: 1
 Vert. spacing: 0 No. down: 3

Base URL:

The guide options

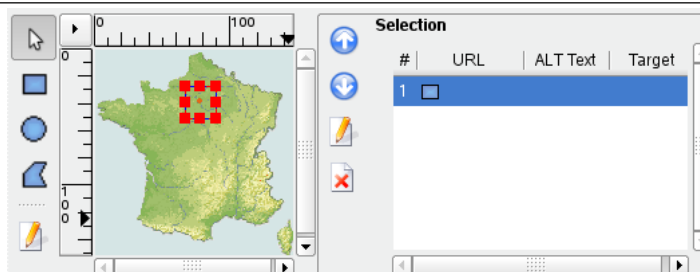
Instead of creating geometrical shapes to select the active areas you may use an array of rectangles, each representing an active area, by clicking on the “Create guides”. In the menu popping up you set the width and height of the rectangles, the space between them, the number of rows and columns, and the upper and left startpoint for the array. All measures are in pixels. If you are not satisfied with the result you may adjust each rectangle by moving the red squares as usual.

17.15.2.3.2 The Tool Bar

Most entries here are just shortcuts for some functions already described. Exceptions:

Move to Front; Send to Back Here you can move an area entry to the bottom (“Move to Front”) or top (“Send to Back”) of the area list.

17.15.2.3.3 The Working Area

Figure 17.404 The Working Area

In the main area of the imagemap window, on the left side, you will find your working area where you can draw all the shapes areas you want with the relevant tools.

Beside the working area there are vertically displayed icons, one for pointing, three for calling tools to generate various shape areas, one to edit zone properties, and finally one to erase a selected zone; you can call these functions with the Mapping menu too.

Caution



Note that the areas should not overlap.

17.15.2.3.4 The selection area

On the right is a display area, as a property list of the created areas. A click on one item of the list selects automatically the corresponding shape in the working area, then you can modify it.

Beside the display is an icon vertical set; its use is obvious but a help pop-up gives you some information about each function.

Unfortunately, the arrow symbols for moving a list entry up or down do not work here. But of course you carefully avoided to create overlapping areas, so you do not use these functions at all.

17.15.3 Semi-Flatten

17.15.3.1 Overview

The Semi-flatten filter helps those in need of a solution to anti-aliasing indexed images with transparency. The GIF indexed format supports complete transparency (0 or 255 alpha value), but not semi-transparency (1 - 254): semi-transparent pixels will be transformed to no transparency or complete transparency, ruining anti-aliasing you applied to the logo you want to put onto your Web page.

Before applying the filter, it's essential that you should know the background color of your Web page. Use the color-picker to determine the exact color which pops up as the Foreground color of the Toolbox. Invert FG/BG colors so that BG color is the same as Web background color.

Semi-flatten process will combine FG color to layer (logo) color, proportionally to corresponding alpha values, and will rebuild correct anti-aliasing. Completely transparent pixels will not take the color. Very transparent pixels will take a few color and weakly transparent will take much color.

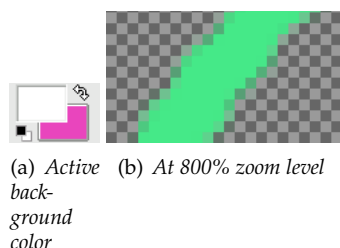
17.15.3.2 Activate the filter

You can access this filter in the image window menu through Filters → Web → Semi-Flatten. It is available if your image holds an Alpha channel (see Section 16.7.33). Otherwise, it is greyed out.

17.15.3.3 Example

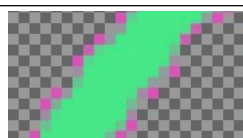
In the example below, the Toolbox Background color is pink, and the image has feathered edges on a transparent background.

Figure 17.405 Semi-Flatten example



Full transparency is kept. Semi-transparent pixels are colored with pink according to their transparency (Alpha value). This image will well merge into the pink background of the new page.

Figure 17.406 Semi-Flatten filter applied

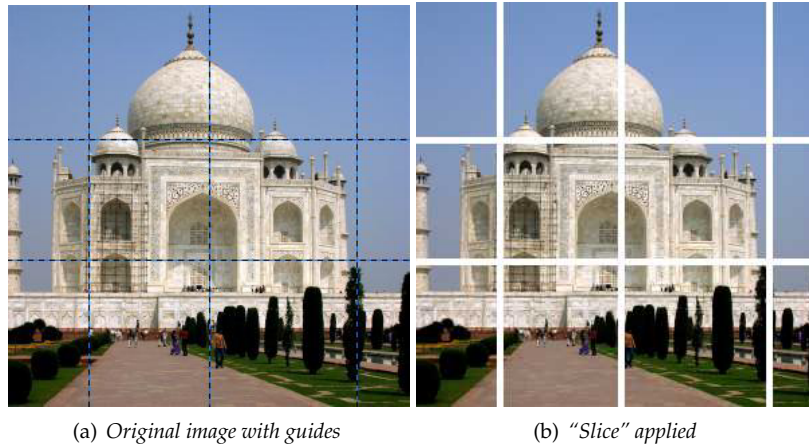


Result, in GIF format, after applying Semi-flatten filter.

17.15.4 Slice

17.15.4.1 Overview

Figure 17.407 Example for the “Slice” filter



(a) Original image with guides

(b) “Slice” applied

This filter is a simple and easy to use helper for creating sensitive images to be used in HTML files. The filter slices up the source image (like the [Slice Using Guides](#) command does) along its horizontal and vertical guides, and produces a set of sub-images. At the same time it creates a piece of HTML code for a table saved in a text file. Every table cell contains one part of the image. The text file should then be embedded in an HTML document.

Note that this filter is really a very simple helper. A typical HTML code produced by the filter may be not much more than this:

Example 17.1 Simple “Slice” filter example output

```
<table cellpadding="0" border="0" cellspacing="0">
  <tr>
    <td></td>
    <td></td>
  </tr>
  <tr>
    <td></td>
    <td></td>
  </tr>
</table>
```

Produced HTML code; the “style” attribute has been omitted.

When there are no guides in the image, the filter will do nothing. If, however, the guides are just hidden, the filter will work.

Tip



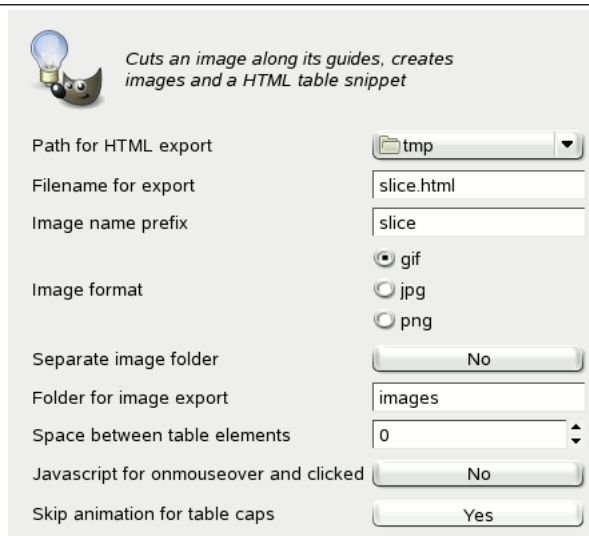
The [ImageMap](#) filter is a much more powerful and sophisticated tool for creating sensitive images. (But it is also much more complex...)

17.15.4.2 Activate the filter

This filter is found in the image window menu under Filters → Web → Slice....

17.15.4.3 Options

Figure 17.408 “Slice” options



Most options are self-explanatory, but nevertheless:

Path for HTML export Where the HTML file and the image files will be saved. By default these files will be stored in the current working directory. Clicking on the button to the right opens a pull-down menu, where you can select a different location.

Filename for export The name of the HTML file. You can change the filename using the textbox.

Image name prefix The name of an image file produced by this filter is `prefix_i_k.ext`, where `prefix` is that part of the filename which you can freely select using the textbox to the right, by default: `slice`. (`i` and `k` are the numbers of the row and the column, each starting with 0; `.ext` is the filename extension depending on the selected Image format.)

This option is particularly useful when you want to create JavaScript for onmouseover and clicked and need different sets of images.

Image format You can choose to create image files in the **GIF**, **JPG**, or **PNG file format**.

Separate image folder, Folder for image export When Separate image folder is enabled, a folder will be created where the image files will be placed. By default, the name of this destination folder is `images`, but you can change it in the Folder for image export textbox.

Example 17.2 With separate image folder

```
<table>
  <tr>
    <td></a></td>
```

Result of enabled “Separate image folder”

Space between table elements This value (0-15) will be passed as “cellspacing” attribute to the HTML table. The result is, that horizontal and vertical guides will be replaced with stripes of the specified width:

Example 17.3 Space between table elements

```
<table cellspacing="5">
```

Corresponding HTML code snippet

Note that the image will not be enlarged by the size of these stripes. Instead, the resulting HTML image will look like you have drawn the stripes with the Eraser tool.

JavaScript for onmouseover and clicked When this option is enabled, the filter will also add some JavaScript code. Like the HTML code, this code does not work as is, rather it's a good starting point for adding some dynamic functionality. The JavaScript code provides a function to handle events like "onmouseover":

Example 17.4 JavaScript code snippet

```
function exchange (image, images_array_name, event)
{
    name = image.name;
    images = eval (images_array_name);

    switch (event)
    {
        case 0:
            image.src = images[name + "_plain"].src;
            break;
        case 1:
            image.src = images[name + "_hover"].src;
            break;
        case 2:
            image.src = images[name + "_clicked"].src;
            break;
        case 3:
            image.src = images[name + "_hover"].src;
            break;
    }
}
```

Skip animation for table caps When disabled, the filter will add a ` ... ` hyperlink stub to every table cell. When enabled (this is the default) and there are at least two horizontal or two vertical guides, the filter will not add a hyperlink stub to the first and last cell in a column or row. This may be useful when you have an image with border and you don't want to make the border sensitive.

Example 17.5 Skipped animation for table caps (simplified HTML code)

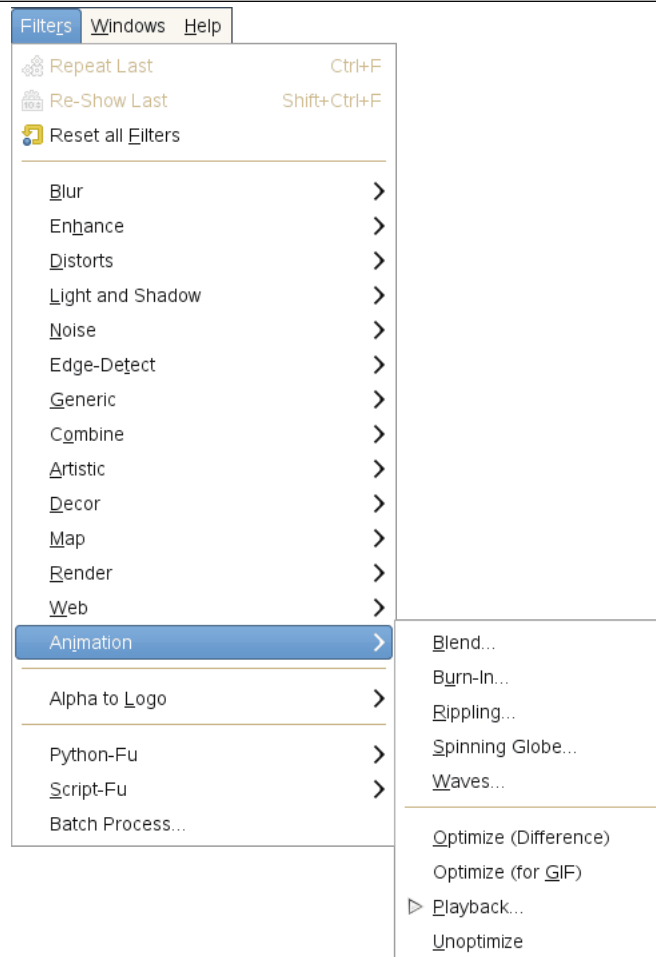
```
<table cellpadding="0" border="0" cellspacing="0">
  <tr>
    <td></td>
    <td></td>
    <td></td>
    <td></td>
  </tr>
  <tr>
    <td></td>
    <td><a href="#"></a></td>
    <td><a href="#"></a></td>
    <td></td>
  </tr>
  <tr>
    <td></td>
    <td></td>
    <td></td>
    <td></td>
  </tr>
</table>
```

Only inner cells have (empty) hyperlinks.

17.16 Animation Filters

17.16.1 Introduction

Figure 17.409 The Animation filters menu



These are animation helpers, which let you view and optimize your animations (by reducing their size). We gathered “Optimize (Difference)” and “Optimize (GIF)” filters together, because they are not much different.

17.16.2 Blend

17.16.2.1 Overview

Figure 17.410 Example for the “Blend” filter: original image

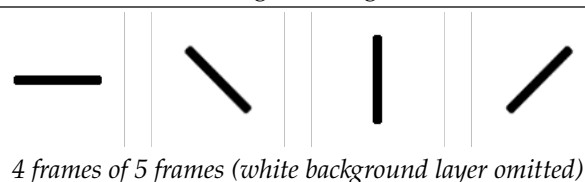
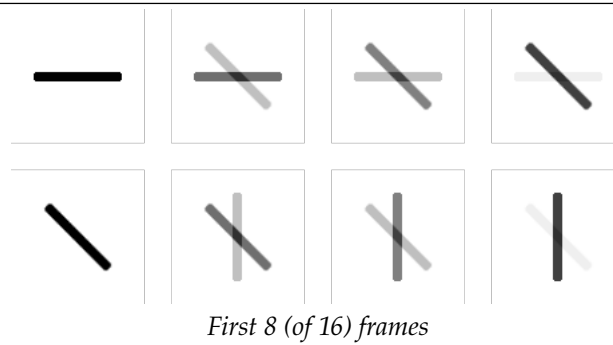


Figure 17.411 Example for the “Blend” filter: filter applied

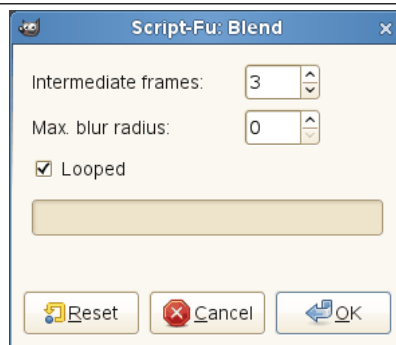


17.16.2.2 Activating the filter

This filter is found in the image window menu under Filters → Animation → Blend....

17.16.2.3 Options

Figure 17.412 “Blend” options



Intermediate frames TODO

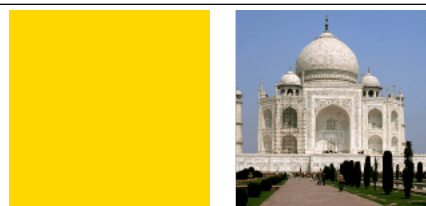
Max. blur radius TODO

Looped TODO

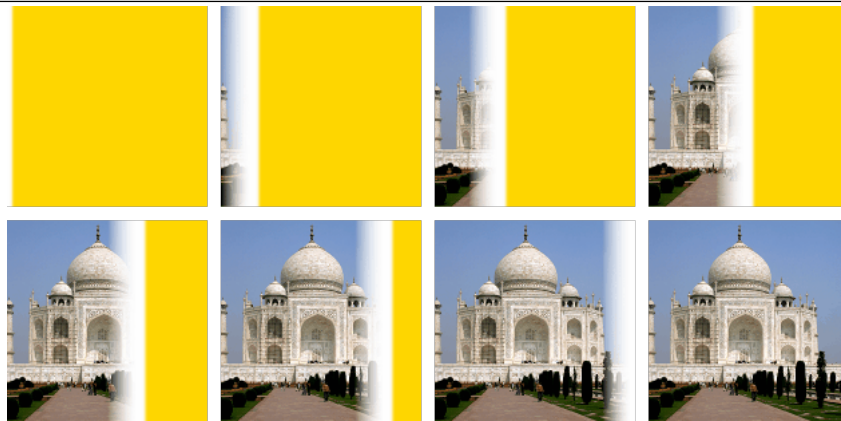
17.16.3 Burn-In

17.16.3.1 Overview

Figure 17.413 Example for the “Burn-In” filter: original image



Opaque background layer and foreground layer with transparency

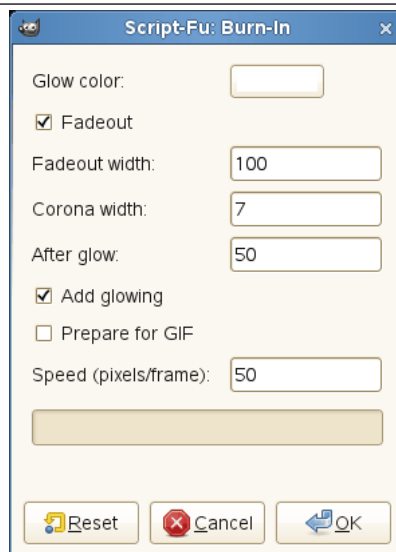
Figure 17.414 Example for the “Burn-In” filter: filter applied

Resulting image with 8 frames (depending on size and speed)

17.16.3.2 Activating the filter

This filter is found in the image window menu under Filters → Animation → Burn-In....

17.16.3.3 Options

Figure 17.415 “Burn-In” options

Glow color TODO

Fadeout TODO

Fadeout width TODO

Corona width TODO

After glow TODO

Add glowing TODO

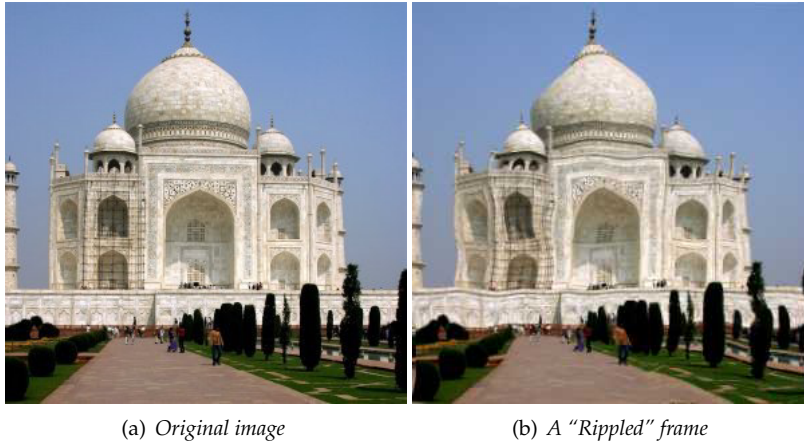
Prepare for GIF TODO

Speed (pixels/frame) TODO

17.16.4 Rippling

17.16.4.1 Overview

Figure 17.416 Example for the “Rippling” filter

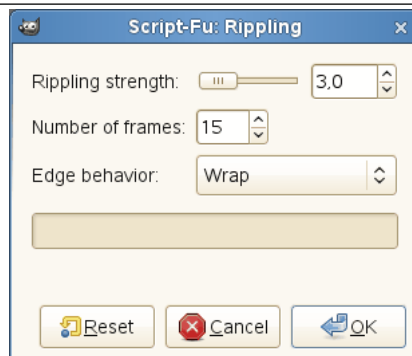


17.16.4.2 Activating the filter

This filter is found in the image window menu under Filters → Animation → Rippling....

17.16.4.3 Options

Figure 17.417 “Rippling” options



Rippling strength TODO

Number of frames TODO

Edge behavior TODO

17.16.5 Spinning Globe

17.16.5.1 Overview

Figure 17.418 Example for the “Spinning Globe” filter: original image



Original image

Figure 17.419 Example for the “Spinning Globe” filter: filter applied



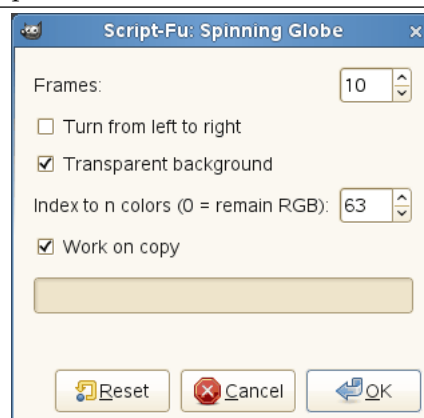
3 (of 10) “Spinning Globe” frames (on a white background)

17.16.5.2 Activating the filter

This filter is found in the image window menu under Filters → Animation → Spinning Globe....

17.16.5.3 Options

Figure 17.420 “Spinning Globe” options



Frames TODO

Turn from left to right TODO

Transparent background TODO

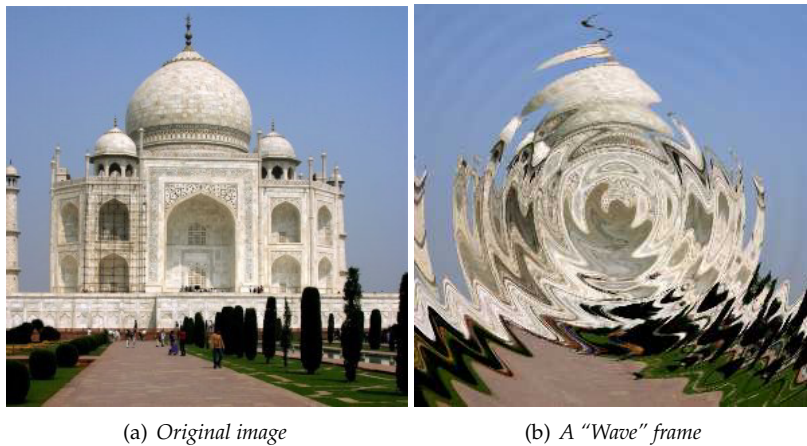
Index to n colors TODO

Work on copy TODO

17.16.6 Waves

17.16.6.1 Overview

Figure 17.421 Example for the “Waves” filter



(a) Original image

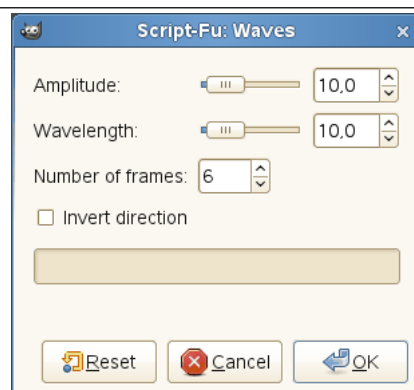
(b) A “Wave” frame

17.16.6.2 Activating the filter

This filter is found in the image window menu under Filters → Animation → Waves....

17.16.6.3 Options

Figure 17.422 “Waves” options



Amplitude TODO

Wavelength TODO

Number of frames TODO

Invert direction TODO

17.16.7 Optimize

17.16.7.1 Overview

An animation can contain several layers and so its size can be important. This is annoying for a Web page. The Optimize filters let you reduce this size. Many elements are shared by all layers in an animation; so they can be saved only once instead of being saved in all layers, and what has changed in each layer can be saved only.

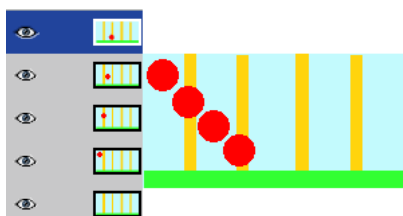
GIMP offers two Optimize filters: Optimize (Difference) and Optimize (GIF). Their result doesn't look very different.

17.16.7.2 Activate filters

You can find these filters in the image menu:

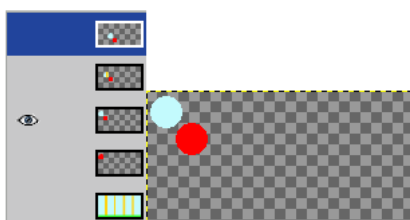
- Filters → Animation → Optimize (Difference)
- Filters → Animation → Optimize (for GIF)
- Filters → Animation → Unoptimize

17.16.7.3 Example for the Optimize animation filters



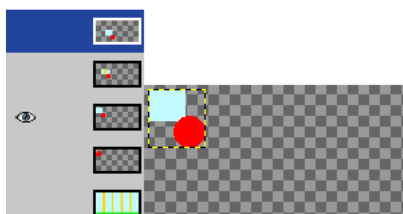
Original image

In this animation, the red ball goes downwards and past vertical bars. File size is 600 Kb.



Optimize (Difference)

File size moved to 153 Kb. Layers held only the part the background which will be used to remove the trace of the red ball. The common part of layers is transparent.



Optimize (GIF)

File size moved to 154 Kb, a bit bigger in the present example, but layer size has been reduced. Layers held only a rectangular selection which includes the part of the background which will be used to remove the trace of the red ball. The common part of layers is transparent.

17.16.7.4 Unoptimize

The "Unoptimize" filter removes any optimizations on a layer-based animation. You may need this command if you want to edit the animation and it's not possible or not useful to **undo** any changes and start editing from the original image.

17.16.8 Playback

17.16.8.1 Overview

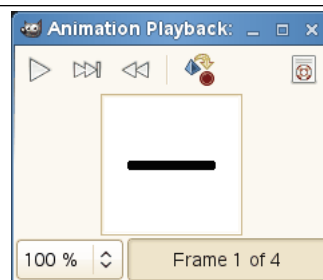
This plug-in lets you play an animation from a multi-layers image (that could be saved in the GIF, MNG or even XCF format), to test it.

17.16.8.2 Activate the filter

You can find this filter through Filters → Animation → Playback...

17.16.8.3 Options

Figure 17.423 “Playback” filter options



This dialog has:

Preview This preview of the animation automatically fits the frame size. The number of the displayed frame is shown below the preview.

Buttons Three buttons are available:

Play/Stop Play/Stop to play or stop the animation.

Rewind Rewind to re-launch the animation from start.

Step Step to play the animation step by step.

Part IV

Keys and Mouse Reference

17.17 File

File — Key reference for the File menu

File

Ctrl + N New image

Shift + Ctrl + V Create From Clipboard

Ctrl + O Open image

Ctrl + Alt + O Open image as layers

Ctrl + 1 Open recent image #1

Ctrl + 2 Open recent image #2

Ctrl + 3 Open recent image #3

Ctrl + 4 Open recent image #4

Ctrl + 5 Open recent image #5

Ctrl + 6 Open recent image #6

Ctrl + 7 Open recent image #7

Ctrl + 8 Open recent image #8

Ctrl + 9 Open recent image #9

Ctrl + 0 Open recent image #10

Ctrl + S Save the XCF image

Shift + Ctrl + S Save image with a different name

Ctrl + E Export

Shift + Ctrl + E Export As...: save image to various file formats

Ctrl + P Print...

Ctrl + Alt + F Show image in file manager

Ctrl + W Close Window

Shift + Ctrl + W Close All

Ctrl + Q Quit

17.18 Edit

Edit — Key reference for Edit menu

Edit

Undo/redo

Ctrl + Z Undo

Ctrl + Y Redo

Clipboard

Ctrl + C Copy selection

Note



This places a copy of the selection to the GIMP clipboard.

Ctrl + C Copy visible

Ctrl + X Cut selection

Ctrl + V Paste clipboard

Note



This places the clipboard objects as a floating selection.

Ctrl + Alt + V Paste in place

Ctrl + Shift + V Paste as new image

Fill

Del Erase selection

Ctrl + , Fill with FG Color

Ctrl + . Fill with BG Color

Ctrl + ; Fill with Pattern

17.19 Select

Select — Key reference for Select menu

Selections

Ctrl + T Toggle selections

Ctrl + A Select all

Shift + Ctrl + A Select none

Ctrl + I Invert selection

Shift + Ctrl + L Float selection

Shift + V Path to selection

17.20 View

View — Key reference for View menu

View

Window

F10 Main Menu

Shift + F10, right click Drop-down Menu

F11 Toggle fullscreen

Tab Toggle the visibility of toolbox and dialogs docks

Shift + Q Toggle quickmask

Ctrl + W Close document window

Shift + J Center image in window

Shift + Ctrl + J Fit image in window

Note



Menus can also be activated by **Alt** with the letter underscored in the menu name.

Zoom

+ Zoom in

- Zoom out

1 Zoom 1:1

Ctrl + J Shrink wrap

Note



This fits the window to the image size.

Ctrl+ mouse wheel Zoom

Flip and Rotate (0°)

! Reset Flip and Rotate

Scrolling (panning)

arrows Scroll canvas

middle button drag Scroll canvas

mouse wheel Scroll canvas vertically

Shift + mouse wheel Scroll canvas horizontally

Note

Scrolling by keys is accelerated, i.e. it speeds up when you press Shift+arrows, or jumps to the borders with Ctrl+arrows.

Rulers and Guides

Mouse drag Drag off the horizontal or vertical ruler to create a new guide line. Drag a line onto the ruler to delete it.

Ctrl + mouse drag Drag a sample point out of the rulers

Shift + Ctrl + R Toggle rulers

Shift + Ctrl + T Toggle guides

17.21 Image

Image — Key reference for Image menu

Image

Ctrl + D Duplicate image

Alt + Return Image properties

17.22 Layers

Layer — Key reference for Layer menu

Layers

Shift + Ctrl + N New layer

Shift + Ctrl + D Duplicate layer

Page Up Select the layer above

Page Down Select the layer below

Home Select the first layer

End Select the last layer

Ctrl + M Merge visible layers

Ctrl + H Anchor layer

17.23 Tools

Tools — Key reference for the Tools menu

Tools

Select Tools

R Rectangle Select

E Ellipse Select

F Free Select

U Fuzzy Select

Shift + O Select By Color

I Intelligent Scissors

Paint Tools

Shift + B Bucket Fill

G Gradient

N Pencil

P Paintbrush

Shift + E Eraser

A Airbrush

K Ink

Y MyPaint Brush

C Clone

H Heal

Shift + U Blur/Sharpen

S Smudge

Shift + D Dodge/Burn

Transform Tools

Q Alignment

M Move

Shift + C Crop

Shift + R Rotate

Shift + S Scale

Shift + H Shear

Shift + P Perspective

Shift + T Unified Transform

Shift + L Handle Transform

Shift + F Flip

Shift + G Cage Transform

W Warp Transform

Other Tools

B Paths

T Text

O Color Picker

Shift + M Measure

Z Zoom

The Zoom tool has some specific reference keys: see [Zoom tool](#).

Note



Click on a tool icon to open its Tool Options dialog.

Context

Ctrl + B Toolbox

D Default Colors

X Swap Colors

Note



Click on the colors to change the colors.

17.24 Filters

Filters — Key reference for Filters menu

Filters

Ctrl + F Repeat last filter

Shift + Ctrl + F Reshow last filter

17.25 Windows

Windows — Key reference for Windows menu

Dockable Dialogs

Ctrl + L Layers

Shift + Ctrl + B Brushes

Shift + Ctrl + P Patterns

Ctrl + G Gradients

Note

These open a new dialog window if it isn't open yet, otherwise the corresponding dialog gets focus.

Within a Dialog

Enter Set the new value

Space, Enter Activate current button or list

Within a multi-tab dialog

Ctrl + Alt + Page Up Switch tabs up

Ctrl + Alt + Page Down Switch tabs down

Within a File Dialog

Alt + Up Up-Folder

Alt + Down Down-Folder

Alt + Home Home-Folder

Esc Close Dialog

Miscellaneous items

Ctrl + B Raise the Toolbox

Tab Hide Docks

17.26 Help

Help — Key reference for Help menu

Help

F1 Help

Shift + F1 Context Help

/ Search and run a command

17.27 Zoom tool

Zoom tool — Key reference for the Zoom tool

Zoom tool

click Zoom in

Ctrl + click Zoom out

mouse drag Zoom in inside the area

Ctrl + mouse drag Zoom out inside the area

Part V
Glossary

Alpha

An Alpha value indicates the transparency of a pixel. Besides its Red, Green and Blue values, a pixel has an alpha value. The smaller the alpha value of a pixel, the more visible the colors below it. A pixel with an alpha value of 0 is completely transparent. A pixel with an alpha value of 255 is fully opaque.

With some image [file formats](#), you can only specify that a pixel is completely transparent or completely opaque. Other file formats allow a variable level of transparency.

Alpha Channel

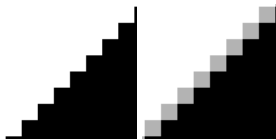
An alpha [channel](#) of a layer is a grayscale image of the same size as the layer representing its transparency. For each pixel the gray level (a value between 0 and 255) represents the pixels's Alpha value. An alpha channel can make areas of the layer to appear partially transparent. That's why the background layer has no alpha channel by default.

The image alpha channel, which is displayed in the channels dialog, can be considered as the alpha channel of the final layer when all layers have been merged.

See also [Example for Alpha channel](#).

Antialiasing

Antialiasing is the process of reversing an alias, that is, reducing the "jaggies". Antialiasing produces smoother curves by adjusting the boundary between the background and the pixel region that is being antialiased. Generally, pixel intensities or opacities are changed so that a smoother transition to the background is achieved. With selections, the opacity of the edge of the selection is appropriately reduced.



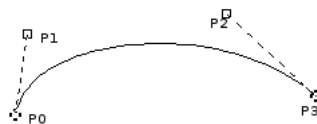
Bézier curve

A spline is a curve which is defined mathematically and has a set of control points. A Bézier spline is a cubic spline which has four control points, where the first and last control points (knots or anchors) are the endpoints of the curve and the inner two control points (handles) determine the direction of the curve at the endpoints.

In the non-mathematical sense, a spline is a flexible strip of wood or metal used for drawing curves. Using this type of spline for drawing curves dates back to shipbuilding, where weights were hung on splines to bend them. The outer control points of a Bézier spline are similar to the places where the splines are fastened down and the inner control points are where weights are attached to modify the curve.

Bézier splines are only one way of mathematically representing curves. They were developed in the 1960s by Pierre Bézier, who worked for Renault.

Bézier curves are used in GIMP as component parts of [Paths](#).



The image above shows a Bézier curve. Points P0 and P3 are points on the Path, which are created by clicking with the mouse. Points P1 and P2 are handles, which are automatically created by GIMP when you stretch the line.

Bitmap

From *The Free Online Dictionary of Computing* (13 Mar 01) :

bitmap — A data file or structure which corresponds bit for bit with an image displayed on a screen, probably in the same format as it would be stored in the display's video memory or maybe as a device independent bitmap. A bitmap is characterised by the width and height of the image in pixels and the number of bits per pixel which determines the number of shades of grey or colors it can represent. A bitmap representing

a colored image (a “pixmap”) will usually have pixels with between one and eight bits for each of the red, green, and blue components, though other color encodings are also used. The green component sometimes has more bits than the other two to cater for the human eye’s greater discrimination in this component.

BMP

BMP is an uncompressed image **file format** designed by Microsoft and mainly used in Windows. Colors are typically represented in 1, 4 or 8 bits, although the format also supports more. Because it is not compressed and the files are large, it is not very well suited for use in the internet.

Bump mapping

Bump mapping is a technique for displaying extremely detailed objects without increasing the geometrical complexity of the objects. It is especially used in 3-dimensional visualization programs. The trick is to put all the necessary information into a texture, with which shadowing is shown on the surface of the object.

Bump mapping is only one (very effective) way of simulating surface irregularities which are not actually contained in the geometry of the model.

Channel Mask

A channel mask is a special type of mask which determines the transparency of a selection. See [Masks](#) for a detailed description.

Channel encoding

Channel encoding refers to how fast the intensity (more technically correct for grayscale and RGB images, the **relative Luminance**) of a channel in a digital image progresses from dark to light as the channel values progress from 0.0 to 1.0 floating point (0 to 255 for 8-bit integer, 0 to 65535 for 16-bit integer).

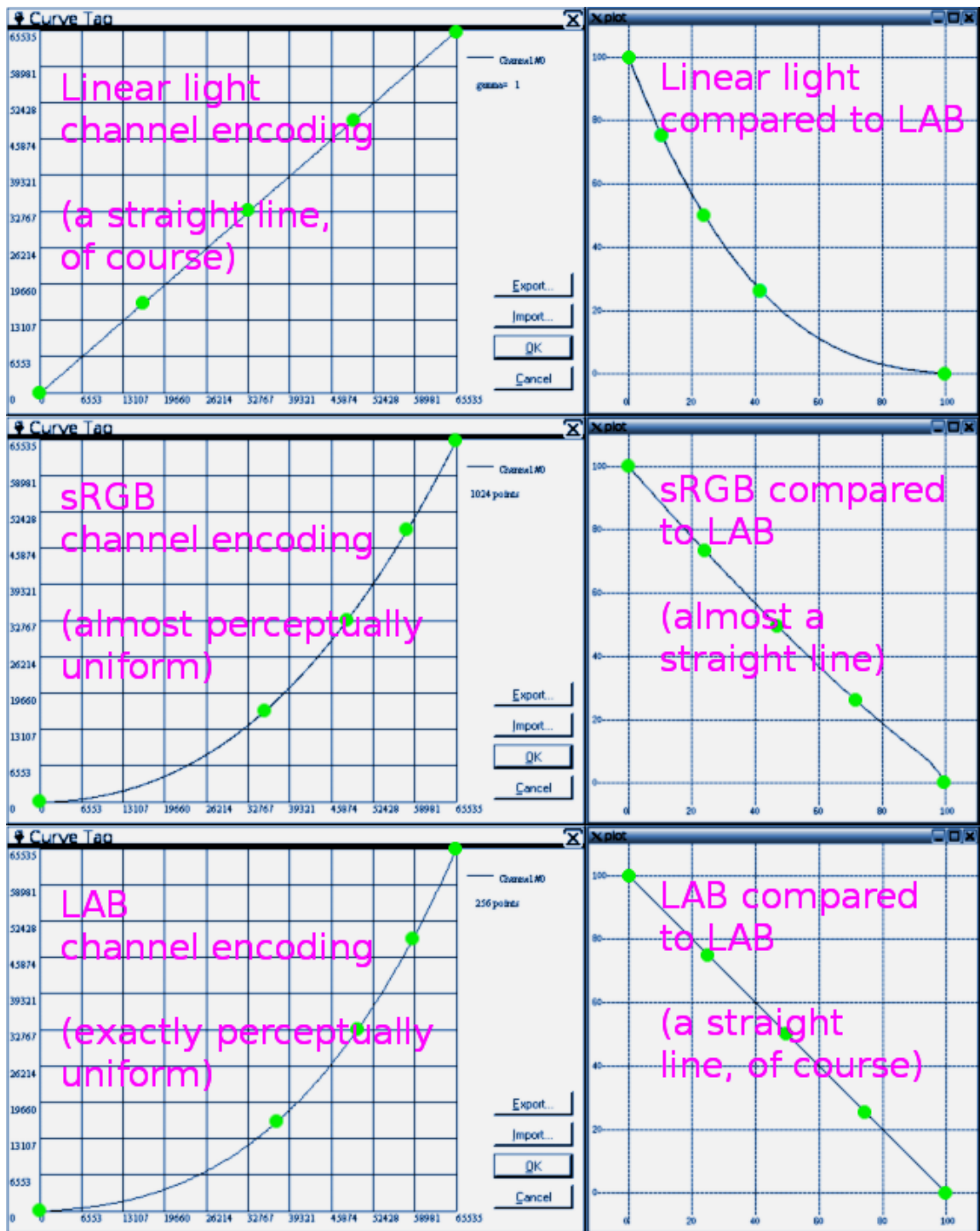
Other ways of referring to “channel encoding” include “companding curve”, “gamma” (which is technically not correct unless the channel encoding is an actual gamma curve), “tone reproduction curve” (“TRC” for short), and “tone response curve” (also “TRC” for short).

The linear light channel encoding reflects the way lightwaves combine there in the real world. The linear light channel encoding is also referred to as “gamma=1.0”, “linear gamma” or simply “linear”.

Perceptually uniform channel encodings reflects the way our eyes respond to changes in luminance.

In ICC profile color managed workflows, the following channel encodings are commonly used:

1. The LAB companding curve, which is exactly perceptually uniform.
2. The linear light channel encoding, which of course is exactly linear.
3. The sRGB channel encoding and the “gamma=2.2” channel encoding, which are both approximately perceptually uniform and approximately equal to each other.
4. The “gamma=1.8” channel encoding, which is neither linear nor approximately perceptually uniform, though it’s closer to being perceptually uniform than it is to being linear.



The Linear light, sRGB, and LAB channel encodings compared.

Looking at the above image:

1. The Linear light channel encoding (top row) represents how lightwaves combine out there in the real world.
2. The sRGB channel encoding (middle row) is almost perceptually uniform.
3. The LAB channel encoding (bottom row) is exactly perceptually uniform, which means it represents how our eyes respond to changes in luminance.

In GIMP 2.10 two different channel encodings are used internally for various editing operations, these being "Linear light" and "Perceptually uniform (sRGB)".

The companding-curves-compared.png shown above is a slightly modified version of an image from [Completely Painless Programmer's Guide to XYZ, RGB, ICC, xyY, and TRCs](#), which is licensed

as [Creative Commons Attribution-ShareAlike 3.0 Unported License](#).

Channel

A channel refers to a certain component of an image. For instance, the components of an **RGB** image are the three primary colors red, green, blue, and sometimes transparency (alpha).

Every channel is a grayscale image of exactly the same size as the image and, consequently, consists of the same number of pixels. Every pixel of this grayscale image can be regarded as a container which can be filled with a value ranging from 0 to 255. The exact meaning of this value depends on the type of channel, e.g. in the RGB color model the value in the *R*-channel means the amount of red which is added to the color of the different pixels; in the selection channel, the value denotes how strongly the pixels are selected; and in the alpha channel the values denote how opaque the corresponding pixels are. See also [Channels](#).

Clipboard

The Clipboard is a temporary area of memory which is used to transfer data between applications or documents. It is used when you Cut, Copy or Paste data in GIMP.

The clipboard is implemented slightly differently under different operating systems. Under Linux/XFree, GIMP uses the XFree clipboard for text and the GIMP internal image clipboard for transferring images between image documents. Under other operating systems, the clipboard may work somewhat differently. See the GIMP documentation for your operating system for further information.

The basic operations provided by the clipboard are “Cut”, “Copy”, and “Paste”. Cut means that the item is removed from the document and copied to the clipboard. Copy leaves the item in the document and copies it to the clipboard. Paste copies the contents of the clipboard to the document. The GIMP makes an intelligent decision about what to paste depending upon the target. If the target is a canvas, the Paste operation uses the image clipboard. If the target is a text entry box, the paste operation uses the text clipboard.

Color

On the one hand, **light** comes from the sun or other radiant sources, and is **refracted** by mediums (water, the atmosphere, glass) and **diffusely** or **specularly** reflected by surfaces.

On the other hand, **color** isn't out there in the world in the same tangible way that light is. Rather color is part of how we sense the world around us. Light enters the eyes, is processed by light receptors (**cones** and **rods**), and sent via the optic nerves to the brain for further processing and interpretation.

Light varies in **wavelengths**, which our eyes and brain interpret as varying hues (reds, blues, greens, and so on), and also in **intensity** (aka “**luminance**”). So our **perception of color** is composed of both intensity (“luminance”) information and chromaticity information.

The **naming of colors** carries one out of the narrow realm of color perception, and into the larger realm of cultural and linguistic interpretation and classification of color, and thence into even larger philosophical, aesthetic, theological, and metaphysical considerations.

The above explanation of Color is a slightly modified excerpt from the [Completely Painless Programmer's Guide to XYZ, RGB, ICC, xyY, and TRCs](#), which is licensed as [Creative Commons Attribution-ShareAlike 3.0 Unported License](#).

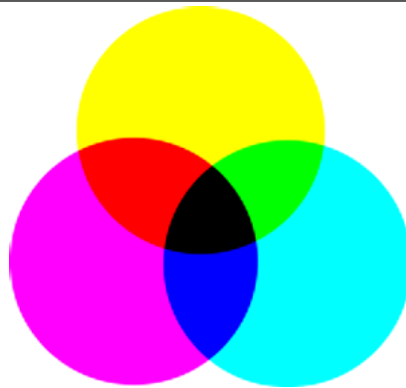
CMY, CMYK

CMYK is a **color model** which has components for Cyan, Magenta, Yellow and Black. It is a subtractive color model, and that fact is important when an image is printed. It is complementary to the **RGB** color model.

The values of the individual colors vary between 0% and 100%, where 0% corresponds to an unprinted color, and 100% corresponds to a completely printed area of color. Colors are formed by mixing the three basic colors.

The last of these values, K (Black), doesn't contribute to the color, but merely serves to darken the other colors. The letter K is used for Black to prevent confusion, since B usually stands for Blue.

Figure 17.424 Subtractive color model



GIMP does not currently support the CMYK model. (An experimental plug-in providing rudimentary CMYK support can be found [[PLUGIN-SEPARATE](#)].)

This is the mode used in printing. These are the colors in the ink cartridges in your printer. It is the mode used in painting and in all the objects around us, where light is reflected, not emitted. Objects absorb part of the light waves and we see only the reflected part. Note that the cones in our eyes see this reflected light in RGB mode. An object appears Red because Green and Blue have been absorbed. Since the combination of Green and Blue is Cyan, Cyan is absorbed when you add Red. Conversely, if you add Cyan, its complementary color, Red, is absorbed. This system is *subtractive*. If you add Yellow, you decrease Blue, and if you add Magenta, you decrease Green.

It would be logical to think that by mixing Cyan, Magenta and Yellow, you would subtract Red, Green and Blue, and the eye would see no light at all, that is, Black. But the question is more complex. In fact, you would see a dark brown. That is why this mode also has a Black value, and why your printer has a Black cartridge. It is less expensive that way. The printer doesn't have to mix the other three colors to create an imperfect Black, it just has to add Black.

Color depth

Color depth is simply the number of bits used to represent a color (bits per pixel : bpp). There are 3 channels for a pixel (for Red, Green and Blue). GIMP can support 8 bits per channel, referred as *eight-bit color*. So, GIMP color depth is $8 * 3 = 24$, which allows $256 * 256 * 256 = 16,777,216$ possible colors (8 bits allow 256 colors).

Color model

A color model is a way of describing and specifying a color. The term is often used loosely to refer to both a color space system and the color space on which it is based.

A color space is a set of colors which can be displayed or recognized by an input or output device (such as a scanner, monitor, printer, etc.). The colors of a color space are specified as values in a color space system, which is a coordinate system in which the individual colors are described by coordinate values on various axes. Because of the structure of the human eye, there are three axes in color spaces which are intended for human observers. The practical application of that is that colors are specified with three components (with a few exceptions). There are about 30 to 40 color space systems in use. Some important examples are:

- RGB
- HSV
- CMY(K)
- YUV
- YCbCr

Display-referred

The phrase "display-referred" refers to images that can be displayed (either directly or by means of ICC profile color management) on devices. The displaying device might be a monitor, or an image printed on paper, or some other display technology.

Regardless of the technology, when you display an image on a device, that device has a maximum and minimum brightness. The maximum and minimum brightnesses are referred to as **display-referred white** and **display-referred black**.

The above explanation is a slightly modified excerpt from [Models for image editing: Display-referred and scene-referred](#). The modified excerpt was written and quoted by permission of the author, who has licensed the modified excerpt under the [Creative Commons Attribution-ShareAlike 3.0 Unported License](#).

Display-referred white

"Display-referred white" (or for simplicity, "white") means the floating point RGB color (1.0, 1.0, 1.0) and the integer equivalents (255,255,255),(65535,65535,65535), etc, for 8-bit integer, 16-bit integer, etc.

"Display-referred white" has the very special significance that in display-referred editing there's no such thing as "brighter than white". So in display-referred image editing, all RGB channel values are less than or equal to 1.0 and no color is brighter than "white", (1.0, 1.0, 1.0).

The above explanation is a slightly modified excerpt from [Models for image editing: Display-referred and scene-referred](#). The modified excerpt was written and quoted by permission of the author, who has licensed the modified excerpt under the [Creative Commons Attribution-ShareAlike 3.0 Unported License](#).

Display-referred black

"Display-referred black" (or for simplicity, "black") means the floating point RGB color (0.0, 0.0, 0.0) and its integer equivalents. This color has the very special significance that there's no such thing as "less bright than black". So in display-referred image editing, all RGB channel values are greater than or equal to 0.0 and no color is less bright than "black", (0.0, 0.0, 0.0).

The above explanation is a slightly modified excerpt from [Models for image editing: Display-referred and scene-referred](#). The modified excerpt was written and quoted by permission of the author, who has licensed the modified excerpt under the [Creative Commons Attribution-ShareAlike 3.0 Unported License](#).

Dithering

Dithering is a technique used in computer graphics to create the illusion of more colors when displaying an image which has a low **color depth**. In a dithered image, the missing colors are reproduced by a certain arrangement of pixels in the available colors. The human eye perceives this as a mixture of the individual colors.

The **Gradient tool** uses dithering. You may also choose to use dithering when you convert an image to **Indexed** format. If you are working on an image with indexed colors, some tools (such as the pattern fill tool) may also use dithering, if the correct color is not available in the colormap.

The **Newsprint** filter uses dithering as well. You can use the **NL Filter** (Non Linear filter) to remove unwanted dithering noise from your image.

Also note that although GIMP itself uses 24-bit colors, your system may not actually be able to display that many colors. If it doesn't, then the software in between GIMP and your system may also dither colors while displaying them.

See also the glossary entry on **Floyd-Steinberg dithering**, which is used in GIMP.

EXIF

Exchangeable image file format (official abbreviation Exif, not EXIF) is a specification for the image file format used by digital cameras. It was created by the Japan Electronic Industry Development Association (JEIDA). The specification uses the existing JPEG, TIFF Rev. 6.0, and RIFF WAVE file formats, with the addition of specific metadata tags. It is not supported in JPEG 2000 or PNG. Version 2.1 of the specification is dated June 12, 1998 and version 2.2 is dated April 2002. The Exif tag structure is taken from that of TIFF files. There is a large overlap between the tags defined in the TIFF, Exif, TIFF/EP and DCF standards [[WKPD-EXIF](#)].

Feathering

The process of Feathering makes a smooth transition between a region and the background by softly blending the edges of the region.



In GIMP, you can feather the edges of a selection. Brushes can also have feathered edges.

File Format

A file format or file type is the form in which computer data is stored. Since a file is stored by an operating system as a linear series of bytes, which cannot describe many kinds of real data in an obvious way, conventions have been developed for interpreting the information as representations of complex data. All of the conventions for a particular “kind” of file constitute a file format.

Some typical file formats for saving images are JPEG, TIFF, PNG and GIF. The best file format for saving an image depends upon how the image is intended to be used. For example, if the image is intended for the internet, file size is a very important factor, and if the image is intended to be printed, high resolution and quality have greater significance. See [Format types](#).

Floating Selection

A floating selection (sometimes called a “floating layer”) is a type of temporary layer which is similar in function to a normal layer, except that a floating selection must be [anchored](#) before you can resume working on any other layers in the image.

Floating selections are described in [Section 16.4.5](#).

In early versions of GIMP, when GIMP did not use layers, floating selections were used for performing operations on a limited part of an image (you can do that more easily now with layers). Now floating selections have no practical use, but you must know what you have to do with them.

Floyd-Steinberg Dithering

Floyd-Steinberg dithering is a method of [dithering](#) which was first published in 1976 by Robert W. Floyd and Louis Steinberg. The dithering process begins in the upper left corner of the image. For each pixel, the closest available color in the palette is chosen and the difference between that color and the original color is computed in each RGB channel. Then specific fractions of these differences are dispersed among several adjacent pixels which haven’t yet been visited (below and to the right of the original pixel). Because of the order of processing, the procedure can be done in a single pass over the image.

When you convert an image to [Indexed](#) mode, you can choose between two variants of Floyd-Steinberg dithering.

Gamma

Gamma or gamma correction is a non-linear operation which is used to encode and decode luminance or color values in video or still image systems. It is used in many types of imaging systems to straighten out a curved signal-to-light or intensity-to-signal response. For example, the light emitted by a CRT is not linear with regard to its input voltage, and the voltage from an electric camera is not linear with regard to the intensity (power) of the light in the scene. Gamma encoding helps to map the data into a perceptually linear domain, so that the limited signal range (the limited number of bits in each RGB signal) is better optimized perceptually.

Gamma is used as an exponent (power) in the correction equation. Gamma compression (where $\gamma < 1$) is used to encode linear luminance or RGB values into color signals or digital file values, and gamma expansion (where $\gamma > 1$) is the decoding process, and usually occurs where the current-to-voltage function for a CRT is non-linear.

For PC video, images are encoded with a gamma of about 0.45 and decoded with a gamma of 2.2. For Mac systems, images are typically encoded with a gamma of about 0.55 and decoded with a

gamma of 1.8. The sRGB color space standard used for most cameras, PCs and printers does not use a simple exponential equation, but has a decoding gamma value near 2.2 over much of its range.

In GIMP, gamma is an option used in the brush tab of the **GIMPressionist** filter and in the **Flame** filter. The **display filters** also include a Gamma filter. Also see the **Levels Tool**, where you can use the middle slider to change the gamma value.

Gamut

In color reproduction, including computer graphics and photography, the gamut, or color gamut (pronounced / gæm t/), is a certain complete subset of colors. The most common usage refers to the subset of colors which can be accurately represented in a given circumstance, such as within a given color space or by a certain output device. Another sense, less frequently used but not less correct, refers to the complete set of colors found within an image at a given time. In this context, digitizing a photograph, converting a digitized image to a different color space, or outputting it to a given medium using a certain output device generally alters its gamut, in the sense that some of the colors in the original are lost in the process. [WIKIPEDIA-GAMUT]

GIF

GIF™ stands for Graphics Interchange Format. It is a **file format** with good, lossless compression for images with low **color depth** (up to 256 different colors per image). Since GIF was developed, a new format called **Portable Network Graphics (PNG)** has been developed, which is better than GIF in all respects, with the exception of animations and some rarely-used features.

GIF was introduced by CompuServe in 1987. It became popular mostly because of its efficient, LZW compression. The size of the image files required clearly less disk space than other usual graphics formats of the time, such as PCX or MacPaint. Even large images could be transmitted in a reasonable time, even with slow modems. In addition, the open licensing policy of CompuServe made it possible for any programmer to implement the GIF format for his own applications free of charge, as long as the CompuServe copyright notice was attached to them.

Colors in GIF are stored in a color table which can hold up to 256 different entries, chosen from 16.7 million different color values. When the image format was introduced, this was not a much of a limitation, since only a few people had hardware which could display more colors than that. For typical drawings, cartoons, black-and-white photographs and similar uses, 256 colors are quite sufficient as a rule, even today. For more complex images, such as color photographs, however, a huge loss of quality is apparent, which is why the format is not considered to be suitable for those purposes.

One color entry in the palette can be defined to be transparent. With transparency, the GIF image can look like it is non-rectangular in shape. However, semi-transparency, as in **PNG**, is not possible. A pixel can only be either entirely visible or completely transparent.

The first version of GIF was 87a. In 1989, CompuServe published an expanded version, called 89a. Among other things, this made it possible to save several images in one GIF file, which is especially used for simple animation. The version number can be distinguished from the first six bytes of a GIF file. Interpreted as ASCII symbols, they are "GIF87a" or "GIF89a".

GNU

The GNU project was started in 1983 by Richard Stallman with the goal of developing a completely free operating system. It is especially well-known from the GNU General Public License (GPL) and GNU/Linux, a GNU-variant with a Linux kernel.

The name came about from the naming conventions which were in practice at MIT, where Stallman worked at the time. For programs which were similar to other programs, recursive acronyms were chosen as names. Since the new system was to be based on the widespread operating system, Unix, Stallman looked for that kind of name and came up with GNU, which stands for "GNU is not Unix". In order to avoid confusion, the name should be pronounced with the "G", not like "new". There were several reasons for making GNU Unix-compatible. For one thing, Stallman was convinced that most companies would refuse a completely new operating system, if the programs they used wouldn't run on it. In addition, the architecture of Unix made quick, easy and distributed development possible, since Unix consists of many small programs that can be developed independently of each other, for the most part. Also, many parts of a Unix system were freely available to anyone and could therefore be directly integrated into GNU, for example, the typesetting system, TeX, or the X Window System. The missing parts were newly written from the ground up.

GIMP (GNU Image Manipulation Program) is an official GNU application [[WKPD-GNU](#)].

Grayscale

Grayscale is a mode for encoding the colors of an image which contains only black, white and shades of gray.

When you create a new image, you can choose to create it in Grayscale mode (which you can colorize later, by changing it to RGB mode). You can also change an existing image to grayscale by using the [Grayscale](#), [Desaturate](#), [Decompose](#), [Channel Mixer](#), although not all formats will accept these changes. Although you can create images in Grayscale mode and convert images to it, it is not a color model, in the true sense of the word.

As explained in [RGB mode](#), 24-bit GIMP images can have up to 256 levels of gray. If you change from Grayscale to RGB mode, your image will have an RGB structure with three color channels, but of course, it will still be gray.

Grayscale image files (8-bit) are smaller than RGB files.

Guides

Guides are lines you can temporarily display on an image while you are working on it. You can display as many guides as you would like, in either the horizontal or the vertical direction. These lines help you position a selection or a layer on the image. They do not appear when the image is printed.

For more information see Section [12.2.2](#).

High Dynamic Range

With [display-referred](#) data you have roughly two and half stops of head room above middle gray and maybe six and a half useable stops below middle gray, at which point the data is too densely packed into too few tonal steps to accurately display differences between solid black and "just barely gray". So at best you have 9 stops of dynamic range, compared to the 20 or more stops of dynamic range you might find in some (certainly not all!) real world scenes.

The usual solution to the dynamic range limitations of display-referred data is to allow channel values to be however high as is needed to encode the scene data. This means allowing channel values that are above display-referred white.

Several file formats currently supported by GIMP 2.10 can be used to import and export high dynamic range images, including floating point tiffs, OpenEXR, and FITS.

When working with high dynamic range data in GIMP 2.10, the [channel encoding](#) does need to be linear to avoid gamma artifacts.

Editing high dynamic range data requires that there isn't any clamping code in editing operations and blend modes. At floating point precision:

1. Many (but not all) GIMP 2.10 blend modes are unclamped, including Normal, Addition, Subtract, Multiply, Lighten Only, Darken Only, Difference, and the LCH and Luminance blend modes. Blend modes such as Screen, Soft Light, and Overlay are not unclamped as these operations are designed to work with display-referred data.
2. Many (too many to list but certainly not all, as some editing operations are designed to work with display-referred data) GIMP 2.10 editing operations also are unclamped, including Levels, Exposure, transforms such as scaling and rotating, and various filter operations such as Gaussian blur.

Portions of the above explanation of "high dynamic range" are slightly modified excerpts from the [Models for image editing: Display-referred and scene-referred](#). These excerpts are quoted by permission and the modified excerpts are licensed as [Creative Commons Attribution-ShareAlike 3.0 Unported License](#).

Histogram

In digital image processing, a histogram is a graph representing the statistical frequency of the gray values or the color values in an image. The histogram of an image tells you about the occurrence of gray values or color values, as well as the contrast range and the brightness of the image. In a color image, you can create one histogram with information about all possible colors, or three histograms for the individual color channels. The latter makes the most sense, since most procedures are based on grayscale images and therefore further processing is immediately possible.

HSV

HSV is a **color model** which has components for Hue (the color, such as blue or red), Saturation (how strong the color is) and Value (the brightness).

The RGB mode is very well suited to computer screens, but it doesn't let us describe what we see in everyday life; a light green, a pale pink, a dazzling red, etc. The HSV model takes these characteristics into account. HSV and RGB are not completely independent of each other. You can see that with the Color Picker tool; when you change a color in one of the color models, the other one also changes. Brave souls can read *Grokking the GIMP*, which explains their interrelationship.

Brief description of the HSV components:

Hue This is the color itself, which results from the combination of primary colors. All shades (except for the gray levels) are represented in a *chromatic circle*: yellow, blue, and also purple, orange, etc. The chromatic circle (or "color wheel") values range between 0° and 360°. (The term "color" is often used instead of "Hue". The RGB colors are "primary colors".)

Saturation This value describes how pale the color is. A completely unsaturated color is a shade of gray. As the saturation increases, the color becomes a pastel shade. A completely saturated color is pure. Saturation values go from 0 to 100, from white to the purest color.

Value This value describes the luminosity, the luminous intensity. It is the amount of light emitted by a color. You can see a change of luminosity when a colored object is moved from being in the shadow to being in the sun, or when you increase the luminosity of your screen. Values go from 0 to 100. Pixel values in the three channels are also luminosities: "Value" in the HSV color model is the maximum of these elementary values in the RGB space (scaled to 0-100).

HTML notation

A hex triplet is a way of encoding a color for a computer. The "#" symbol indicates that the numbers which follow it are encoded in hexadecimal. Each color is specified in two hexadecimal digits which make up a triplet (three pairs) of hexadecimal values in the form "#rrggbb", where "rr" represents red, "gg" represents green and "bb" represents blue.

Image Hose

An image hose in GIMP is a special type of brush which consists of several images. For example, you could have a brush with footprints, which consists of two images, one for the left footprint and one for the right. While painting with this brush, a left footprint would appear first, then a right footprint, then a left one, etc. This type of brush is very powerful.

An image hose is also sometimes called an "image pipe" or "animated brush". An image hose is indicated in the Brushes dialog by a small red triangle in the lower right corner of the brush's symbol.

For information concerning creating an image hose, please see the Section [7.8](#) and Section [7.7](#).

Incremental, paint mode

Incremental mode is a paint mode where each brush stroke is drawn directly on the active layer. When it is set, each additional stroke of the brush increases the effect of the brush, up to the maximum opacity for the brush.

If incremental mode is not set, brush strokes are drawn on a canvas buffer, which is then combined with the active layer. The maximum effect of a brush is then determined by the opacity, and stroking with the brush repeatedly does not increase the effect beyond this limit.



The two images above were created using a brush with spacing set to 60 percent. The image on the left shows non-incremental painting and the image on the right shows the difference with incremental painting.

Incremental mode is a tool option that is shared by several brush tools, except those which have a "rate" control, which automatically implies an incremental effect. You can set it by checking the Incremental checkbox in the tool option dialog for the tool (Paintbrush, Pencil and Eraser).

Indexed Colors

Indexed color mode is a mode for encoding colors in an image where each pixel in the image is assigned an 8-bit color number. The color which corresponds to this number is then put in a table (the palette). Changing a color in the palette changes all the pixels which refer to this palette color. Although you can create images in *Indexed Color* mode and can transform images to it, it is, strictly speaking, not a **color model**.

See also the **Indexed Palette** section and the **Convert Image to Indexed Colors** command.

Interpolation

Interpolation means calculating intermediate values. When you enlarge (“digitally zoom”) or otherwise transform (rotate, shear or give perspective to) a digital image, interpolation procedures are used to compute the colors of the pixels in the transformed image. GIMP offers three interpolation methods, which differ in quality and speed. In general, the better the quality, the more time the interpolation takes (see **Interpolation methods**).

GIMP uses interpolation when you **Scale** an image, **Scale** a layer, and when you **Transform** an image.

IPTC

IPTC is an acronym for International Press Telecommunications Council which developed the Information Interchange Model (IIM) for text, image and other media types metadata. Refer to **[IPTC]**.

JPEG

JPEG is a **file format** which supports compression and works at all color depths. The image compression is adjustable, but beware: Too high a compression could severely reduce image quality, since JPEG compression is lossy.

Use JPEG to create web graphics or if you don’t want your image to take up a lot of space. JPEG is a good format for photographs and for computer-generated images (CGI). It is not well suited for:

- digital line drawings (for example, screenshots or vector graphics), in which there are many neighboring pixels with the same color values, few colors and hard edges,
- Black and white images (only black and white, one bit per pixel) or
- half-toned images (newsprint).

Other formats, such as GIF, PNG or JBIG, are far better for these kinds of images.

In general, JPEG transformations are not reversible. Opening and then saving a JPEG file causes a new, lossy compression. Increasing the quality factor later will not bring back the image information which was lost.

L*a*b*

The Lab color space (also called the L*a*b* color space) is a **color model** developed in the beginning of the 1930s by the Commission Internationale d Eclairage (CIE). It includes all the colors that the human eye can perceive. That contains the colors of the RGB and the CMYK color spaces, among others. In Lab, a color is indicated by three values: L, a and b. Here, the L stands for the luminance component — corresponding to the gray value — and a and b represent the red-green and blue-yellow parts of the color, respectively.

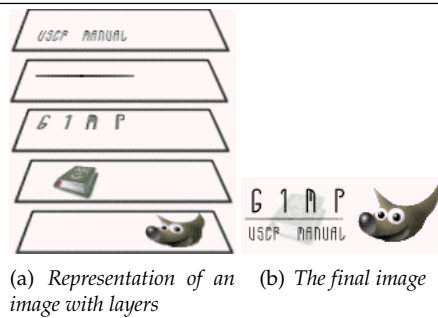
In contrast to RGB or CMYK, Lab is not dependent upon the various input and output devices. For that reason, it is used as an exchange format between devices. Lab is also the internal color model of PostScript Level II.

Layer

You can think of layers as being a stack of slides which are more or less transparent. Each layer represents an aspect of the image and the image is the sum of all of these aspects. The layer at the bottom of the stack is the background layer. The layers above it are the components of the foreground.

You can view and manage the layers of the image through the **Layers dialog**.

Figure 17.425 Example image with layers



Marching Ants

Marching ants is a term which describes the dotted line which surrounds a selection. The line is animated, so it looks as if little ants are running around behind each other.

Masks

A mask is like a veil put over a layer (layer mask) or all the layers of an image (selection mask). You can remove this mask by painting with white color, and you can complete it by painting with black color. When the mask is “applied”, non masked pixels will remain visible (the others will be transparent) or will be selected, according to the type of mask.

There are two types of masks:

- *Layer Mask*: Every layer can have its own mask. The layer mask represents the Alpha channel of the layer and allows you to manage its transparency. By painting on the layer mask, you can make parts of the layer opaque or transparent: painting with black makes the layer transparent, painting with white makes the layer opaque and painting with shades of gray makes the layer semi-transparent. You can use all paint tools to paint on the mask. You can also apply a filter or copy-paste. You can use the Layer mask for transition effects, volume effects, merging elements from another image, etc. See the [Layer Mask](#) section for more details.
- *Channel Mask*, also called *Selection Mask*: Channel Masks determine the transparency of a selection. By painting on a Channel Mask with white, you remove the mask and increase the selection; with black, you reduce the selection. This procedure lets you create a selection very precisely. You can also save your selections to a Channel Mask with the [Save to Channel](#) command. You can retrieve it later by using the “Channel to selection” command from the [Channel menu](#). Channel masks are so important in GIMP that a special type has been implemented: the [Quick mask](#). See the [Selection mask](#) section for more details.

Moiré Effect

The moiré effect (pronounce “Moa-ray”) is an unintended pattern which appears when a regular pattern of grids or lines interferes with another regular pattern placed over it. This can happen, for example, when you are scanning an image with a periodic structure (such as a checkered shirt or a half-toned image), scanning a digital image, taking a digital photograph of a periodic pattern, or even when silkscreening.

If you discover the problem in time, the best solution is to move the original image a little bit in the scanner or to change the camera angle slightly.

If you cannot re-create the image file, GIMP offers some filters which may help you with the problem. For more information, see the [Despeckle](#) and [NL Filter](#) (Non-Linear) filters.

Parasite

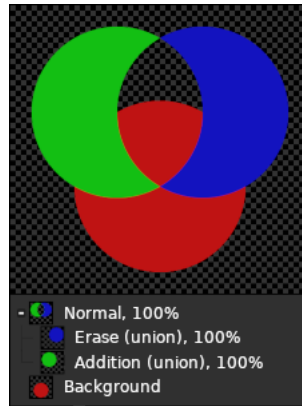
A Parasite is additional data which may be written to an XCF file. A parasite is identified by a name, and can be thought of as an extension to the other information in an XCF file.

Parasites of an image component may be read by GIMP plug-ins. Plug-ins may also define their own parasite names, which are ignored by other plug-ins. Examples of parasites are comments, the save options for the TIFF, JPEG and PNG file formats, the gamma value the image was created with and EXIF data.

Pass-through

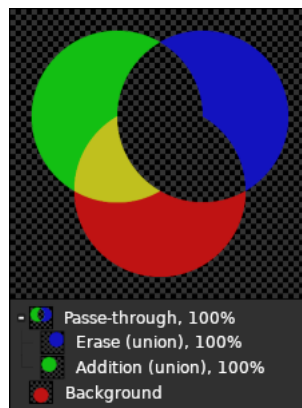
Normally, the layers inside a layer group are isolated from the rest of the image -- the layer group is essentially a separate sub-image, living inside the bigger image; you can merge the group into a single layer, replace the original group with it, and the result would be the same.

In following examples, the names of the relevant layers in the images specify the layer mode, with the composite mode in parentheses where applicable, and the layer's opacity.



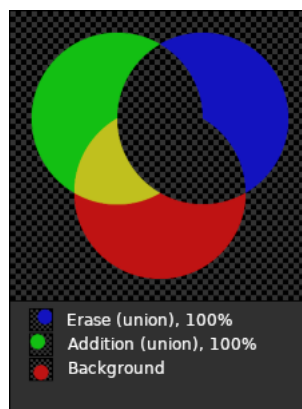
In this example, the group uses Normal mode; note that the green and blue layers don't affect the red layer: the green layer's color isn't added to the red layer's color, and the blue layer only erases the green layer.

Layer groups using Pass-through mode are different: the layers inside them "see" the layers below the group, and interact with them according to their layer mode.



In this example, the group uses Pass-through mode. Note that the green layer's color is added to the red layer's color, and the blue layer erases both the green and the red layers.

In simple cases, pass-through groups behave as though there is no group involved at all.



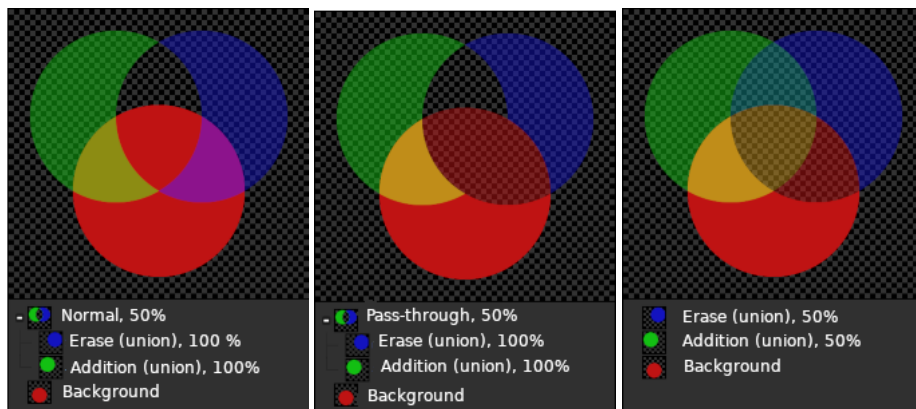
The green and blue layers are not inside a group, and the result is the same as in the preceding example.

In these cases, the group is primarily an organizational tool: it allows you to group together several layers, achieving some desired effect, and handle them as a unit.

However, in general, pass-through groups are not equivalent to having no group at all. For example, when the group's opacity is less than 100%, pass-through groups still behave as a single

unit, applying the opacity to the group as a whole (like a normal group would) rather than to the individual layers, while still letting the group layers interact with the background layers.

Figure 17.426 Three images



Compare these three images, which demonstrate the same compositions as above, with the group (or the individual layers, in the last example) having an opacity of 50%. When using pass-through groups to group together several layers achieving a collective effect, the group's opacity essentially lets you control the "strength" of the effect, which can't be achieved using either normal groups, or individual layers.

Path

A Path is a contour composed of straight lines, curves, or both. In GIMP, it is used to form the boundary of a selection, or to be *stroked* to create visible marks on an image. Unless a path is stroked, it is not visible when the image is printed and it is not saved when the image is written to a file (unless you use XCF format).

See the [Paths Concepts](#) and [Using Paths](#) sections for basic information on paths, and the [Path Tool](#) section for information on how to create and edit paths. You can manage the paths in your image with the [Paths dialog](#).

PDB

All of the functions which GIMP and its extensions make available are registered in the Procedure Database (PDB). Developers can look up useful programming information about these functions in the PDB by using the [Procedure Browser](#).

PDF

PDF (Portable Document Format) is a [file format](#) which was developed by Adobe to address some of the deficiencies of PostScript. Most importantly, PDF files tend to be much smaller than equivalent PostScript files. As with PostScript, GIMP's support of the PDF format is through the free Ghostscript libraries.

Pixel

A pixel is a single dot, or "picture element", of an image. A rectangular image may be composed of thousands of pixels, each representing the color of the image at a given location. The value of a pixel typically consists of several [Channels](#), such as the Red, Green and Blue components of its color, and sometimes its Alpha (transparency).

Plugin

Optional extensions for the GIMP. Plugins are external programs that run under the control of the main GIMP application and provide specific functions on-demand. See [Section 13.1](#) for further information.

PNG

PNG is the acronym of "Portable Network Graphic" (pronounce "ping"). This recent format offers many advantages and a few drawbacks: it is not lossy and gives files more heavy than the JPEG format, but it is perfect for saving your images because you can save them several times without

losing data each time (it is used for this Help). It supports True Colors (several millions of colors), indexed images (256 colors like GIF), and 256 transparency levels (while GIF supports only two levels).

PostScript

Created by Adobe, PostScript is a page description language mainly used by printers and other output devices. It's also an excellent way to distribute documents. GIMP does not support PostScript directly: it depends on a powerful free software program called Ghostscript.

The great power of PostScript is its ability to represent vector graphics—lines, curves, text, paths, etc.—in a resolution-independent way. PostScript is not very efficient, though, when it comes to representing pixel-based raster graphics. For this reason, PostScript is not a good format to use for saving images that are later going to be edited using GIMP or another graphics program.

PSD

PSD is Adobe Photoshop's native **file format**, and it is therefore comparable to **XCF** in complexity. GIMP's ability to handle PSD files is sophisticated but limited: some features of PSD files are not loaded, and only older versions of PSD are supported. Unfortunately, Adobe has now made the Photoshop Software Development Kit — which includes their file format specifications — proprietary, and only available to a limited set of developers approved by Adobe. This does not include the GIMP development team, and the lack of information makes it very difficult to maintain up-to-date support for PSD files.

Quantization

Quantization is the process of reducing the color of a pixel into one of a number of fixed values by matching the color to the nearest color in the colormap. Actual pixel values may have far more precision than the discrete levels which can be displayed by a digital display. If the display range is too small, then abrupt changes in colors (false contours, or banding) may appear where the color intensity changes from one level to another. This is especially noticeable in Indexed images, which have 256 or fewer discrete colors.

One way to reduce quantization effects is to use **Dithering**. The operations in GIMP which perform dithering are the **Gradient tool** (if you have enabled the dithering option) and the **Convert to Indexed** command. However, they only work on RGB images and not on Indexed images.

Rendering Intent

Rendering intents are ways of dealing with colors that are out-of- **Gamut** colors present in the source space that the destination space is incapable of producing. There are four rendering intents defined by the ICC:

Perceptual This rendering intent is typically used for photographic content. It scales one gamut to fit into the other while maintaining the relative position of colors.

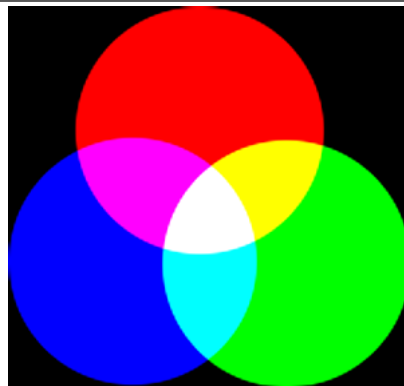
Relative colorimetric This rendering intent is typically used for spot colors. Colors that are not out of gamut are left unchanged. Colors outside the gamut are converted to colors with the same lightness, but different saturation, at the edge of the gamut.

Saturation This method is typically used for business graphics. The relative saturation of colors is mostly maintained, but lightning is usually changed.

Absolute colorimetric This rendering intent is most often used in proofing. It preserves the native device white point of the source image.

RGB

Figure 17.427 Additive color model



RGB is a **color model** which has components for Red, Green and Blue. These colors are emitted by screen elements and not reflected as they are with paint. The resulting color is a combination of the three primary RGB colors, with different degrees of lightness. If you look closely at your television screen, whose pitch is less than that of a computer screen, you can see the red, green and blue elements lit with different intensities. The RGB color model is *additive*.

GIMP uses eight bits per channel for each primary color. That means there are 256 intensities (Values) available, resulting in $256 \times 256 \times 256 = 16,777,216$ colors.

It is not obvious why a given combination of primary colors produces a particular color. Why, for instance, does $229R+205G+229B$ give a shade of pink? This depends upon the human eye and brain. There is no color in nature, only a continuous spectrum of wavelengths of light. There are three kinds of cones in the retina. The same wavelength of light acting upon the three types of cones stimulates each of them differently, and the mind has learned, after several million years of evolution, how to recognize a color from these differences.

It is easy to see that no light ($0R+0G+0B$) produces complete darkness, black, and that full light ($255R+255G+255B$) produces white. Equal intensity on all color channels produces a level of gray. That is why there can only be 256 gray levels in GIMP.

Mixing two *Primary colors* in RGB mode gives a *Secondary color*, that is, a color in the CMY model. Thus combining Red and Green gives Yellow, Green and Blue give Cyan, Blue and Red give Magenta. Don't confuse secondary colors with *Complementary colors* which are directly opposite a primary color in the chromatic circle:

Figure 17.428 Colorcircle



Mixing a primary color with its complementary color gives gray (a neutral color).

It is important to know what happens when you are dealing with colors in GIMP. The most important rule to remember is that decreasing the intensity of a primary color results in increasing the intensity of the complementary color (and vice versa). This is because when you decrease the value of a channel, for instance Green, you automatically increase the relative importance of the

other two, here Red and Blue. The combination of these two channels gives the secondary color, Magenta, which is the complementary color of Green.

The **Color Picker** tool lets you find out the RGB values of a pixel and the **hextriplet** for the color.

Sample Merged

Sample Merged is an option you can set when you use the **Bucket Fill** tool, the **Color Picker** tool and various selection tools. It is useful when you are working on an image with several layers and the active layer is either semi-transparent or has a **Layer Mode** which is not set to Normal. When you check the Sample Merged option, the color which is used for the operation is the composite color of all the visible layers. When the Sample Merged option is not checked, the color used is the color of the active layer itself.

See also the **Clone Tool** for using Sample Merged in non-destructive image editing.

Saturation

This term refers to color purity. Imagine you add pigment to white paint. Saturation varies from 0 (white, fully toned down, fully diluted) to 100 (pure color).

Scene-referred

When speaking of images captured by a camera, scene-referred means that the intensities in the image RGB channels are proportional to the intensities in the scene that was photographed.

“Scene-referred” is not the same as **high dynamic range**, as the camera might have been aimed at a low dynamic range scene such as a foggy early morning view. However, adding a light source to the captured frame (eg the moon breaking through the clouds or a street lamp) will turn even a foggy morning into a high dynamic range scene.

As lightwaves do combine linearly, by definition a scene-referred image (whether real or imaginary) must be encoded linearly to preserve the scene-referred nature of the data.

Supersampling

Supersampling is a more sophisticated antialiasing technique, that is, a method of reducing jagged and stair-stepped edges along a slanted or curved line. Samples are taken at several locations *within* each pixel, not just at the center, and an average color is calculated. This is done by rendering the image at a much higher resolution than the one being displayed and then shrinking it to the desired size, using the extra pixels for calculation. The result is a smoother transition from one line of pixels to another along the edges of objects.

The quality of the result depends on the number of samples. Supersampling is often performed at a range of 2× to 16× the original size. It greatly increases the amount of time needed to draw the image and also the amount of space needed to store the image in memory.

One way to reduce the space and time requirement is to use Adaptive Supersampling. This method takes advantage of the fact that very few pixels are actually on an object boundary, so only those pixels need to be supersampled. At first, only a few samples are taken within a pixel. If the colors are very similar to each other, only those samples are used to calculate the final color. If not, more samples are used. This means that the higher number of samples is calculated only where necessary, which improves performance.

SVG

SVG stands for Scalable Vector Graphics. It is a format for two-dimensional vector graphics, both static and animated. You can export GIMP paths to SVG and you can import SVG documents into GIMP from a vector graphic software. See [[WKPD-SVG](#)] for more details.

TGA

TGA (TARGA Image File) is a **file format** which supports 8, 16, 24 or 32 bits per pixel and optional RLE compression. It was originally developed by the Truevision company. “TGA” stands for Truevision Graphics Adapter and “TARGA” stands for Truevision Advanced Raster Graphics Adapter.

TIFF

TIFF (Tagged Image File Format) is a **file format** which was developed primarily for scanned raster graphics for color separation. Six different encoding routines are supported, each with one of three different image modes: black and white, grayscale and color. Uncompressed TIFF images may be 1, 4, 8 or 24 bits per pixel. TIFF images compressed using the LZW algorithm may be 6, 8 or 24

bits per pixel. Besides PostScript format, TIFF is one of the most important formats for preliminary stages of printing. It is a high quality file format, which is perfect for images you want to import to other programs like FrameMaker or CorelDRAW.

Tile

A Tile is a part of an image which GIMP currently has open. In order to avoid having to store an entire image in memory at the same time, GIMP divides it into smaller pieces. A tile is usually a square of 64 x 64 pixels, although tiles at the edges of an image may be smaller than that.

At any time, a tile may be in main memory, in the tile cache in RAM, or on disk. Tiles which are currently being worked on are in main memory. Tiles which have been used recently are in RAM. When the tile cache in RAM is full, tiles which have been used least recently are written to disk. GIMP can retrieve the tiles from RAM or disk when they are needed.

Do not confuse these tiles with those in the [Tile Filter](#)

URI

A Uniform Resource Identifier (URI) is a string of characters that serves to identify an abstract or a physical resource. URIs are used for the identification of resources in the Internet (such as web pages, miscellaneous files, calling up web services, and for receivers of e-mail) and they are especially used in the Worldwide Web.

URL

URLs (Uniform Resource Locators) are one type of Uniform Resource Identifiers (URIs). URLs identify a resource by its primary access mechanism (commonly http or ftp) and the location of the resource in the computer network. The name of the URI scheme is therefore generally derived from the network protocol used for it. Examples of network protocols are http, ftp and mailto.

Since URLs are the first and most common kinds of URIs, the terms are often used synonymously.

Value

This term often refers to the light intensity, the luminosity of a color. It varies from 0 (black) to 100 (full light).

XCF

XCF is a [file format](#) which is special because it is GIMP's native file format: that is, it was designed specifically to store all of the data that goes to make up a GIMP image. Because of this, XCF files may be quite complicated, and there are few programs other than GIMP that can read them.

When an image is stored as an XCF file, the file encodes nearly everything there is to know about the image: the pixel data for each of the layers, the current selection, additional channels if there are any, paths if there are any, and guides. The most important thing that is *not* saved in an XCF file is the undo history.

The pixel data in an XCF file is represented in a lossless compressed form: the image byte blocks are compressed using the lossless RLE algorithm. This means that no matter how many times you load and save an image using this format, not a single pixel or other image data is lost or modified because of this format. XCF files can become very large, however GIMP allows you to compress the files themselves, using either the gzip or bzip2 compression methods, both of which are fast, efficient, and freely available. Compressing an XCF file will often shrink it by a factor of 10 or more.

The GIMP developers have made a great effort to keep the XCF file format compatible across versions. If you create a file using GIMP 2.0, it ought to be possible to open the file in GIMP 1.2. However, some of the information in the file may not be usable: for example, GIMP 2.0 has a much more sophisticated way of handling text than GIMP 1.2, so a text layer from a GIMP 2.0 XCF file will appear as an ordinary image layer if the file is opened in GIMP 1.2.

Documentation about XCF format can be found at <https://gitlab.gnome.org/GNOME/gimp/blob/master/devel-docs/xcf.txt>.

XMP

XMP is an acronym for Extensible Metadata Platform. It is a metadata format based on XML used in PDF and photographs. Report to [\[XMP\]](#) for detailed explanations.

YCbCr

YCbCr is a **color model** which was developed for the PAL television standard as a simple modification to the YUV color model. In the meantime, it has become the CCIR-601 standard for image and video recording. For example, it is used for JPEG pictures and MPEG videos, and therefore also on DVDs, video CDs and for most other widespread digital video standards. Note that a color model is still not a color space, since it doesn't determine which colors are actually meant by "red", "green" and "blue". For a color space, there must still be a reference to a specific absolute color value.

There are color models which do not express a color by the additive basic colors, red, green and blue (RGB), but by other properties, for example, the brightness-color model. Here, the criteria are the basic brightness of the colors (from black, through gray, to white), the colors with the largest portion (red, orange, yellow, green, blue, violet, or other pure colors that lie between them) and the saturation of the colors ("gaudy" to pale). This color model is based on the ability of the eye to recognize small differences in luminosity better than small color differences, and to recognize those better than small differences in saturation. That makes gray text written on a black background easy to read, but blue text on a red background very hard to read, even with the same basic brightness. Such color models are called brightness-color models.

The YCbCr model is a slight adaptation of such a brightness-color model. An RGB color value is divided into a basic brightness, Y, and two components, Cb and Cr, where Cb is a measurement of the deviation from gray in the blue direction, or if it is less than 0.5, in the direction of yellow. Cr is the corresponding measurement for the difference in the direction of red or turquoise. This representation uses the peculiarity of the eye of being especially sensitive to green light. That is why most of the information about the proportion of green is in the basic brightness, Y, an only the deviations for the red and blue portions need to be represented. The Y values have twice the resolution of the other two values, Cb and Cr, in most practical applications, such as on DVDs.

YUV

YUV is a **color model** which uses two components to represent the color information, luma (the strength of the light per area) and the chrominance, or proportion of color (chroma), where the chrominance again consists of two components. The development of the YUV color model also goes back to the development of color television (PAL), where ways were sought for transmitting the color information along with the black-and-white signal, in order to achieve backwards compatibility with old black and white televisions without having to increase the available transmission bandwidth. From the YUV color model of the analog television techniques, the YCrCb color model was developed, which is used for most kinds of digital image and video compression. Erroneously, the YUV color model is also often spoken about in those fields, although the YCbCr model is actually used. This often causes confusion.

For the calculation of the luma signals, the underlying RGB data is first adjusted with the **gamma** value of the output device, and an R'G'B' signal is obtained. The three individual components are added together with different weights, to form the brightness information, which also functions as the VBS signal (Video Baseband Signal, the black-and-white signal) for the old black and white televisions.

$$Y=R+G+B$$

The exact calculation is more complicated, however, since some aspects of the color perception of the human eye have to be taken into account. For example, green is perceived to be lighter than red, and this is perceived to be lighter than blue. Furthermore, in some systems gamma correction of the basic color is first performed.

The chrominance signals, and the color difference signals also, contain the color information. They are formed by the difference of blue minus luma or red minus luma.

$$U=B-Y$$

$$V=R-Y$$

From the three generated components, Y, U and V, the individual color proportions of the basic color can be calculated again later:

$$Y + U = Y + (B - Y) = Y - Y + B = B$$

$$Y + V = Y + (R - Y) = Y - Y + R = R$$

$$Y - B - R = (R + G + B) - B - R = G$$

Furthermore, because of the structure of the retina of the human eye, it turns out that the brightness information is perceived at a higher resolution than the color, so that many formats based on the YUV color model compress the chrominance to save bandwidth during transmission.

Part VI
Bibliography

17.28 Books

- [APRESS00] Akkana Peck, *Beginning GIMP: From Novice to Professional*, Copyright © 2006 Apress Inc., Apress Inc, www.apress.com, ISBN 1-59059-587-4, <https://gimpbook.com/> .
- [FOLEY01] Foley and van Dam, et al, *Computer Graphics, Principles and Practice*, Copyright © 1990 Addison Wesley, Addison Wesley, .
- [GROKKING] Carey Bunks, *Grokking the Gimp*, Copyright © 2000 New Riders Publishing, New Riders Publishing, www.newriders.com , ISBN 0-7357-0924-6, <http://gimp-savvy.com/BOOK> .

17.29 Online resources

- [APOD] *Astronomy Picture of the Day*, <https://apod.nasa.gov/apod/> .
- [APOD01] *Astronomy Picture of the Day (today)*, <https://apod.nasa.gov/apod/astropix.html> .
- [APOD02] *Astronomy Picture of the Day - The Hubble Ultra Deep Field (2004 March 9)* , <https://apod.nasa.gov/apod/ap040309.html> .
- [APOD03] *Astronomy Picture of the Day - M51: Cosmic Whirlpool (2002 July 10)* , <https://apod.nasa.gov/apod/ap020710.html> .
- [APOD04] *Astronomy Picture of the Day - Saturn: Lord of the Rings (2002 February 15)* , <https://apod.nasa.gov/apod/ap020215.html> .
- [APOD05] *Astronomy Picture of the Day - NGC 6369: The Little Ghost Nebula (2002 November 8)* , <https://apod.nasa.gov/apod/ap021108.html> .
- [APOD06] *Astronomy Picture of the Day - Disorder in Stephan's Quintet (2000 November 13)* , <https://apod.nasa.gov/apod/ap001113.html> .
- [APOD07] *Astronomy Picture of the Day - The Sharpest View of the Sun (2002 November 14)* , <https://apod.nasa.gov/apod/ap021114.html> .
- [ARGYLLCMS] *Argyll Color Management System Home Page*, <https://www.argyllcms.com/> .
- [AdobeRGB] *Adobe RGB (1998) ICC Profile*, <https://www.adobe.com/digitalimag/adobergb.html> .
- [AdvanceMAME] *AdvanceMAME project*, <https://www.advancemame.it/> .
- [BABL] *babl (pixel format translation library)*, <https://www.gegl.org/babl/> .
- [BACH04] Michael Bach, *Face in blocks*, Copyright © 2004 Michael Bach, <https://michaelbach.de/-ot/fcs-mosaic/> .
- [BUDIG01] *Golden Text*, <https://www.home.unix-ag.org/simon/gimp/golden.html> .
- [CAIRO] *Cairo*, <https://www.cairographics.org> .
- [DARWINPORTS] *Darwin Ports Package Manager for OS X*, <https://www.macports.org/> .
- [ECI] *ECI (European Color Initiative) Profiles*, <http://www.eci.org/doku.php?id=en:downloads> .
- [FDL-TRANSLATION] *Unofficial translation of the GNU Free Documentation License*
- [FINK] *Fink Package Manager for OS X*, <https://www.finkproject.org/> .
- [FREETYPE] *Freetype 2 home page*, <https://www.freetype.org/> .
- [GEEQIE] *Homepage of Geeqie, an image browser*, <http://www.geeqie.org> .
- [GEGL] *GEGL (Generic Graphics Library)*, <https://gegl.org> .

- [GEORGIEV01] Todor Georgiev, *Image Reconstruction Invariant to Relighting*, Copyright © 2005 Todor Georgiev, <http://www.tgeorgiev.net/Invariant.pdf> .
- [GHOSTSCRIPT] *Ghostscript project page*, <https://www.ghostscript.com/> .
- [GIMP] *GIMP - The Gnu Image Manipulation Program*, <https://gimp.org> .
- [GIMP-DEV] *GIMP Development*, <https://developer.gimp.org> .
- [GIMP-DEV-PLUGIN] *GIMP Plugin Development*, <https://developer.gimp.org/plugin-ins.html> .
- [GIMP-DOCS] *GIMP Documentation project page*, <https://www.gimp.org/docs/> .
- [GIMP-FONTS] *Fonts in GIMP 2.0*, <https://gimp.org/unix/fonts.html> .
- [GIMP-NEWSYM26] *List of new symbols in GIMP 2.6*, [libgimp-index-new-in-2-6.html](https://gimp.org/unix/newsym26.html) .
- [GPL] *General Public License (GPL)*, <https://www.gnu.org/licenses/gpl-3.0.html> .
- [GROKING01] *Grokking the GIMP*, <https://web.archive.org/web/20170515161709/http://gimp-savvy.com/BOOK/index.html> .
- [GROKING02] *Grokking the GIMP (9.2 Clickable Image Maps)*, <https://web.archive.org/web/20170403234151/http://gimp-savvy.com/BOOK/index.html?node81.html> .
- [GTHUMB] *gThumb - An Image Viewer and Browser for the GNOME Desktop* , <https://wiki.gnome.org/Apps/Gthumb> .
- [GUNTHER04] Gunther Dale, *Making shapes in GIMP*, Copyright © 2004 Dale (Gunther), <https://web.archive.org/web/20151004100006/http://gug.criticalhit.dk/tutorials-gunther1/> .
- [ICC] *INTERNATIONAL COLOR CONSORTIUM*, <https://www.color.org/> .
- [ICCsRGB] *ICC sRGB PROFILES*, <https://www.color.org/srgbprofiles.xalter> .
- [INKSCAPE] *Inkscape is an Open Source vector graphics editor*, <https://inkscape.org> .
- [IPTC] *IPTC Metadata Format*, https://en.wikipedia.org/wiki/IPTC_Information_Interchange_Model .
- [LPROF] *LPROF ICC Profiler*, <http://lprof.sourceforge.net/> .
- [OPENCLIPART-GRADIENT] *Open Clipart - Gradients*, <https://openclipart.org/> .
- [OPENICC] *The OpenICC project*, <https://freedesktop.org/wiki/OpenIcc/> .
- [PLUGIN-FLAMES] *GIMP-Plugin Flames*, <https://draves.org/gimp/flare.html> ; <https://flam3.com/> .
- [PLUGIN-RESYNTH] *Resynthesizer is a Gimp plug-in for texture synthesis*, <https://github.com/bootchk/-resynthesizer> .
- [PLUGIN-RETINEX] *A plugin providing the Retinex algorithm for GIMP*, <https://web.archive.org/web/20200220014231/http://www-prima.inrialpes.fr/pelisson/MSRCR.php> .
- [PLUGIN-SEPARATE] *A plugin providing rudimentary CMYK support for GIMP*, <https://www.blackfiveservices.co.uk/separate.shtml> .
- [PYTHON] *Python Programming Language*, <https://www.python.org> .
- [SCALE2X] *Scale2x*, <https://www.scale2x.it/> .
- [SCRIBUS] *Scribus :: Open Source Desktop Publishing*, <https://www.scribus.net/> .
- [SIOX] *Simple Interactive Object Extraction*, <http://www.siox.org/> .
- [TUT01] Seth Burgess, *Tutorial: How to draw straight lines*, Copyright © 2002 Seth Burgess, https://www.gimp.org/tutorials/Straight_Line .

- [TUT02] Carol Spears, *Tutorial: GIMPLite Quickies*, Copyright © 2004 Carol Spears, https://next.gimp.org/tutorials/Lite_Quickies/ .
- [UNICODE] *Unicode*, <https://home.unicode.org/> .
- [WIKIPEDIA] Wikipedia Foundation, *Wikipedia*, Copyright © 2004 Wikipedia Foundation Inc., <https://www.wikipedia.org> .
- [WKPD-ALPHA] *Wikipedia - Alpha channel*, https://en.wikipedia.org/wiki/Alpha_channel .
- [WKPD-BEZIER] *Wikipedia - Bézier curve*, https://en.wikipedia.org/wiki/Bezier_curve .
- [WKPD-BUMP] *Wikipedia - Bumpmap*, https://en.wikipedia.org/wiki/Bump_Mapping .
- [WKPD-BURN] *Wikipedia - Burning*, https://en.wikipedia.org/wiki/Dodging_and_burning .
- [WKPD-CA] *Wikipedia - Cellular Automata*, https://en.wikipedia.org/wiki/Cellular_Automata .
- [WKPD-CMYK] *Wikipedia - CMYK*, <https://en.wikipedia.org/wiki/CMYK> .
- [WKPD-COLORSPACE] *Wikipedia - Colorspace*, <https://en.wikipedia.org/wiki/Colorspace> .
- [WKPD-DEFLATE] *Wikipedia - Deflate*, <https://en.wikipedia.org/wiki/deflate> .
- [WKPD-DEINTERLACE] *Wikipedia - Deinterlace*, <https://en.wikipedia.org/wiki/Deinterlace> .
- [WKPD-DITHERING] *Wikipedia - Dithering*, <https://en.wikipedia.org/wiki/Dithering> .
- [WKPD-DODGE] *Wikipedia - Dodging*, https://en.wikipedia.org/wiki/Dodging_and_burning .
- [WKPD-EXIF] *Wikipedia - EXIF*, <https://en.wikipedia.org/wiki/EXIF> .
- [WKPD-FILEFORMAT] *Wikipedia - Fileformat*, https://en.wikipedia.org/wiki/Image_file_format .
- [WKPD-GAMUT] *Wikipedia - Gamut*, <https://en.wikipedia.org/wiki/Gamut> .
- [WKPD-GIF] *Wikipedia - GIF*, <https://en.wikipedia.org/wiki/GIF> .
- [WKPD-GNU] *Wikipedia - GNU*, <https://en.wikipedia.org/wiki/GNU> .
- [WKPD-HISTOGRAM] *Wikipedia - Histogram*, https://en.wikipedia.org/wiki/Image_histogram .
- [WKPD-HSV] *Wikipedia - HSV*, https://en.wikipedia.org/wiki/HSL_and_HSV .
- [WKPD-ICC] *Wikipedia - ICC Profile*, https://en.wikipedia.org/wiki/ICC_Profile .
- [WKPD-INTERPOL] *Wikipedia - Interpolation*, <https://en.wikipedia.org/wiki/Interpolation> .
- [WKPD-JPEG] *Wikipedia - JPEG*, <https://en.wikipedia.org/wiki/JPEG> .
- [WKPD-LAB] *Wikipedia - L*a*b*, https://en.wikipedia.org/wiki/Lab_color_space .
- [WKPD-LZW] *Wikipedia - LZW*, <https://en.wikipedia.org/wiki/LZW> .
- [WKPD-MOIRE] *Wikipedia - Moire*, <https://en.wikipedia.org/wiki/Moire> .
- [WKPD-PACKBITS] *Wikipedia - PackBits*, <https://en.wikipedia.org/wiki/PackBits> .
- [WKPD-PNG] *Wikipedia - PNG*, https://en.wikipedia.org/wiki/Portable_Network_Graphics .
- [WKPD-RASTER] *Wikipedia - Raster Graphics*, https://en.wikipedia.org/wiki/Raster_graphics .
- [WKPD-RETINA] *Wikipedia - Retina*, <https://en.wikipedia.org/wiki/Retina> .
- [WKPD-RI] *Wikipedia - Rendering Intent*, https://en.wikipedia.org/wiki/Rendering_intent .
- [WKPD-SEPIA] *Wikipedia - Sepia*, <https://en.wikipedia.org/wiki/Sepia> .
- [WKPD-SUBSAMPLING] *Wikipedia - Chroma subsampling*, https://en.wikipedia.org/wiki/-Chroma_Subsampling .

- [WKPD-SVG] *Wikipedia - SVG*, https://en.wikipedia.org/wiki/Scalable_Vector_Graphics .
- [WKPD-URI] *Wikipedia - URI*, https://en.wikipedia.org/wiki/Uniform_Resource_Identifier .
- [WKPD-URL] *Wikipedia - URL*, https://en.wikipedia.org/wiki/Uniform_Resource_Locator .
- [WKPD-Web-colors] *Wikipedia - Web-colors*, https://en.wikipedia.org/wiki/Web_colors .
- [WKPD-YCBCR] *Wikipedia - YCbCr*, <https://en.wikipedia.org/wiki/YCbCr> .
- [WKPD-YUV] *Wikipedia - YUV*, <https://en.wikipedia.org/wiki/YUV> .
- [XDS] *Direct Save Protocol (XDS)*, <https://freedesktop.org/wiki/Specifications/XDS/> .
- [XMP] *Wikipedia - Extensible Metadata Platform*, https://en.wikipedia.org/wiki/Extensible_Metadata_Platform .

Part VII

GIMP History

.1 The Very Beginning

According to Peter Mattis and Spencer Kimball, the original creators of GIMP, in their announcement of GIMP 0.54:

The GIMP arose from the ashes of a hideously crafted CS164 (compilers) class project. The setting: early morning. We were both weary from lack of sleep and the terrible strain of programming a compiler in LISP. The limits of our patience had long been exceeded, and yet still the dam held.

And then it happened. Common LISP messily dumped core when it could not allocate the 17 MB it needed to generate a parser for a simple grammar using yacc. An unbelieving moment passed, there was one shared look of disgust, and then our project was vapor. We had to write something... *ANYTHING* ... useful. Something in C. Something that did not rely on nested lists to represent a bitmap. Thus, the GIMP was born.

Like the phoenix, glorious, new life sprung out of the burnt remnants of LISP and yacc. Ideas went flying, decisions were made, the GIMP began to take form.

An image manipulation program was the consensus. A program that would at the very least lessen the necessity of using commercial software under “Windoze” or on the “Macintoy”. A program that would provide the features missing from the other X painting and imaging tools. A program that would help maintain the long tradition of excellent and free UNIX applications.

Six months later, we’ve reached an early beta stage. We want to release now to start working on compatibility issues and cross-platform stability. Also, we feel now that the program is actually usable and would like to see other interested programmers developing plug-ins and various file format support.

.2 The Early Days of GIMP

Version 0.54 Version 0.54 was released in February 1996, and had a major impact as the first truly professional free image manipulation program. This was the first free program that could compete with the big commercial image manipulation programs.

Version 0.54 was a beta release, but it was so stable that you could use it for daily work. However, one of the major drawbacks of 0.54 was that the toolkit (the sliders, menus, dialog boxes, etc.) was built on Motif, a commercial toolkit. This was a big drawback for systems like “Linux”, because you had to buy Motif if you wanted to use the faster, dynamically linked GIMP. Many developers were also students running Linux, who could not afford to buy Motif.

Version 0.60 When 0.60 was released in July 1996, it had been under S and P (Spencer and Peter) development for four months. Main programming advantages were the new toolkits, GTK (GIMP Toolkit) and gdk (GIMP Drawing Kit), which eliminated the reliance on Motif. For the graphic artist, 0.60 was full of new features like: basic layers; improved painting tools (sub-pixel sampling, brush spacing); a better airbrush; paint modes; etc.

Version 0.60 was only a developer’s release, and was not intended for widespread use. It served as a workbench for 0.99 and the final 1.0 version, so functions and enhancement could be tested and dropped or changed. You can look at 0.60 as the alpha version of 0.99.

Version 0.99 In February 1997, 0.99 came on the scene. Together with other developers, S and P had made several changes to GIMP and added even more features. The main difference was the new API (Application Programming Interface) and the “PDB”, which made it possible to write scripts; Script-Fus (or macros) could now automate things that you would normally do by hand. GTK/gdk had also changed and was now called GTK+. In addition, 0.99 used a new form of tile-based memory handling that made it possible to load huge images into GIMP (loading a 100 MB image into GIMP is no problem). Version 0.99 also introduced a new native GIMP file format called XCF.

The new API made it really easy to write extensions and plug-ins for GIMP. Several new plug-ins and extensions emerged to make GIMP even more useful (such as SANE, which enables scanning directly into GIMP).

In the summer of 1997, GIMP had reached version 0.99.10, and S and P had to drop most of their support since they had graduated and begun jobs. However, the other developers of GIMP continued under the orchestration of Federico Mena to make GIMP ready for prime time.

GTK+ was separated from GIMP in September 1997. GTK+ had been recognized as an excellent toolkit, and other developers began using it to build their own applications.

GIMP went into feature freeze in October 1997. This meant that no new features would be added to the GIMP core libraries and program. GUM (GIMP Users Manual) version 0.5 was also released early in October 1997. The developing work continued to make GIMP stable and ready for version 1.0.

.3 The One to Change the World

Version 1.0 GIMP version 1.0 was released on June 5, 1998. Finally, GIMP was considered stable enough to warrant a worldwide announcement and professional use.

Version 1.2 GIMP version 1.2.0 was released on December 25, 2000. Compared to the version 1.0, it included mostly fixes and improvements of the user interface.

.4 Version 2.0

First, a statistic: the GIMP code base contains about 230,000 lines of C code, and most of these lines were rewritten in the evolution from 1.2 to 2.0. From the user's point of view, however, GIMP 2 is fundamentally similar to GIMP 1; the features are similar enough that GIMP 1 users won't be lost. As part of the restructuring work, the developers cleaned up the code greatly, an investment that, while not directly visible to the user, will ease maintenance and make future additions less painful. Thus, the GIMP 2 code base is significantly better organized and more maintainable than was the case for GIMP 1.2.

Basic tools The basic tools in GIMP 2 are not very different from their predecessors in GIMP 1. The "Select Regions by Color" tool is now shown in the GIMP toolbox, but was already included in GIMP 1 as a menu option in the Select menu. The Transform tool has been divided into several specialized tools: Rotation, Scale, Shearing and Perspective. Color operations are now associated with layers in the menu Layer → Colors, but this is merely a cleanup: they were already present in the Image menu (illogically, since they are layer operations). Thus no completely new tools appear in this release, but two of the tools have been totally revamped compared to the older versions: the Text tool and the Path tool. More on this below.

The user interface for tools has also changed significantly. The "Tool Options" dialog box was modified to not resize itself when a new tool is chosen. Most users felt that the window changing size when a new tool was selected was annoying. Now, by default the "Tool Options" dialog is constantly open and docked under the toolbox, where it can easily be found.

Tool options The "Tool Options" for many tools have new possibilities that weren't available in GIMP 1. Without being exhaustive, here are the most noticeable improvements.

All selection tools now have mode buttons: Replace, Add, Subtract and Intersect. In GIMP 1 the only way to change the selection mode was to use the **Ctrl** or **Shift** buttons, which could get very confusing because those buttons also had other functions. For example, pressing and holding the **Shift** key while using the Rectangle selection tool forces the rectangle to be a square. Thus, to add a square selection you would first press **Shift**, then click the mouse, then release **Shift**, then press **Shift** again, then sweep out the selection with the mouse, then release **Shift**. It can now be done more easily.

For transformation tools, buttons now control which object (layer, selection or path) is affected by the transformation. You can for example transform a rectangular selection to various quadrilateral shapes. Path transformation in particular is now easier than it was before.

"Fade out" and "Paint Using Gradient" are now available for all drawing tools. In fact, all drawing tools now have their own individual brush, gradient and pattern settings, in contrast to GIMP 1 where there was a single global setting that applied to all drawing tools. Now you can select different brushes for the Pencil and the Paint Brush, or different patterns for the Clone and Fill tools. You can change these setting by using your mouse wheel over the relevant resource button (this is most useful for quickly and easily choosing a brush).

User Interface The most visible changes in GIMP 2 concern the user interface. GIMP now uses the GTK2+ graphical toolkit in place of GTK+. One of the nice features brought by the new libraries is dockable dialogs, and tab navigation between dialogs docked in the same window — a feature

present in several popular web browsers. GIMP 1 was famous for opening dialogs anywhere on your screen; GIMP 2 can be told to use fixed boxes. Dialogs now include a little tab-customization menu, which provides maximum flexibility in organizing your workspace.

The Image window has some interesting new features. These are not necessarily activated by default, but they can be checked as options in the Preferences → Interface → Image Windows menu. “Show Brush Outline”, for example, allows you to see the outline of the brush when using drawing tools. In the “Appearance” sub-section, you can toggle whether a menu bar is present at the top of image windows. You can set an option to work with the new fullscreen mode. Viewing options are also available from all image windows using right click to bring up the menu, then selecting “View”. The so-called “image” menu is also available by clicking on a little triangle in the top left corner of the drawing space. The setting you choose in the “Preferences” dialog is used as the default value, and options you set from an image are used only for that image. (You can also toggle fullscreen mode by using the **F11** key; the **Esc** key also exits fullscreen mode).

GIMP 2 features keyboard accelerators to ease menu access. If you find that navigating through menus using your mouse is onerous, the solution may be to use the keyboard. For example, if the menu bar is present, to create a new image just hit Alt-F-N. Without the menu bar, hit Shift-F10 to open the top-left menu, and use direction keys or **F** then **N** to create the new image. Keyboard accelerators are different from shortcuts: accelerators are useful to navigate through menus, whereas shortcuts call a specific menu item directly. For example, Ctrl-N is a shortcut, and the quickest way to open a new image.

To ease access to your most commonly used menu items, the GIMP has provided dynamic shortcuts for many years. When a menu is open, you can hover over the desired menu item and hold down your shortcut combination. This feature is still present, but is deactivated by default in the GIMP 2.0, to avoid accidental re-assigning of existing shortcuts.

The GIMP also ships with a number of sets of key-bindings for its menus. If you would like to replace the default GIMP keybindings by Photoshop bindings, for example, you can move the file `menurc` in your user data directory to `oldmenurc`, rename `ps-menurc` to `menurc` and restart GIMP.

Handling Tabs and Docks The GIMP 2.0 introduces a system of tabbed dialogs to allow you to make your workspace look the way you want it to be. Almost all dialogs can be dragged to another dialog window and dropped to make a tabbed dialog set.

Furthermore, at the bottom of each dialog, there is a dockable area: drag and drop tabs here to attach dialogs beneath the bottom tab group.

Scripting “Python-fu” is now the standard external scripting interface for GIMP 2. This means that you can now use GIMP functions in Python scripts, or conversely use Python to write GIMP plug-ins. Python is relatively easy to understand even for a beginner, especially in comparison to the Lisp-like Scheme language used for Script-Fu in GIMP 1. The Python bindings are augmented by a set of classes for common operations, so you are not forced to search through the complete GIMP Procedural Database in order to carry out basic operations. Moreover, Python has integrated development environments and a gigantic library, and runs not only on Linux but also on Microsoft Windows and Apples Mac OS X. The biggest drawback, for GIMP 2.0, is that the standard user interface offered in Python-fu does not use the complete power of the Python language. The interface is currently designed to support simple scripts, but a more sophisticated version is a goal of future development.

GIMP-Perl is no longer distributed with the standard GIMP 2 distribution, but is available as a separate package. Currently, GIMP-Perl is supported only on Unix-like operating systems. It includes both a simple scripting language, and the ability to code more polished interfaces using the `Gtk2 perl` module. Direct pixel manipulation is available through the use of `PDL`.

Script-Fu, based on “Scheme”, has the same drawbacks as before: not intuitive, hard to use and lacking a real development environment. It does, however, have one major advantage compared to Python-fu: Script-Fu scripts are directly interpreted by GIMP and do not require any additional software installation. Python-fu requires that you install a package for the Python language.

The Text Tool The big problem with the standard text tool in GIMP 1 was that text could not be modified after it was rendered. If you wanted to change anything about the text, all you could do was “undo” and try again (if you were lucky enough to have sufficient undo history available, and then of course

you would also undo any other work you had done in the meantime). In GIMP 1.2 there was also a “dynamic text” plug-in that allowed you to create special text layers and keep them around indefinitely, in a modifiable form, but it was buggy and awkward to use. The second generation Text tool is an enhanced combination of the old Text tool and the Dynamic Text plugin. Now all options are available in the “Tool Options”: font, font size, text color, justify, antialiasing, indent, spacing. To create a new text item, click in the image and a little editor pops up. Text appears on the image while you are editing (and carriage returns are handled properly!). A new dedicated layer is created; this layer resizes dynamically to match the text you key in. You can import plain text from a file, and you can even do things like writing from right to left in Arabic. If you select a text layer, clicking on it opens the editor, and you can then modify your text.

The Path Tool The second generation Path tool has a completely new interface. The first major difference you notice is that paths are no longer required to be closed. A path can be made up of a number of disjoint curve segments. The next major difference is that now the path tool has three different modes, Design, Edit and Move.

In Design mode, you can create a path, add nodes to an existing path and modify the shape of a curve either by dragging edges of the curve or dragging the “handles” of a node.

In Edit mode, you can add nodes in the middle of curve edges, and remove nodes or edges, as well as change the shape of the curve. You can also connect two path components.

The third mode, Move, is, as you might expect, used to move path components. If your path has several components, you can move each path component separately. To move all components at once, use the **Shift** key.

Two other path-related features are new in the GIMP 2.0. The GIMP can not only import an SVG image as a raster image, but can also keep SVG paths intact as GIMP paths. This means that the GIMP is now more able than ever to complement your favorite vector drawing tool. The other feature which has made the path tool much better is the introduction of vector-based stroking. In previous versions, stroking paths and selections was a matter of drawing a brush-stroke along the path. This mode is still available, but it is now possible to stroke a curve accurately, using the vector library libart.

Other improvements Some other improvements in brief:

- Higher-quality antialiasing in some places — most notably in the Text tool.
- Icons and menus are skinnable. You can create your own icon set and apply it to the toolbox using the Preference → Interface menu option. A theme called “small” is included with the standard distribution.
- An image can be saved as a template and used to create new images.
- There are four new combination modes for layers that lie one on top of another within an image: “Hard Light”, “Soft Light”, “Grain Extract” and “Grain Merge”.
- If there is an active selection, you can crop the image directly to the selection size using image menu Image → Crop.
- As well as being able to create guides, there’s now a grid functionality in GIMP. It is complementary to the guides functionality and makes it easier to position objects so that they align perfectly.
- The Layers dialog is more coherent, in that there are no more hidden functions accessed only with right click on the miniature image of the layer that appears there. You can now handle layer operations directly from the image menu: Layer Mask, Transparency, Transformation and Layer Color operations are directly in the Layer submenu.
- Color display filters are now available from the image menu View → Display Filters. Using them, you can simulate different gamma values, different contrasts, or even color deficient vision, without altering your original image. This actually has been a feature of the GIMP developer versions for a long time, but it has never been stable enough to appear in a stable version of the GIMP before.
- The color selection dialog has a new CMYK mode, associated with the printer icon.
- Data stored in EXIF tags by digital cameras are now handled in read and write mode for JPEG files.

- MNG animations are now supported. The MNG file format can be considered as animated PNG. It has all the advantages of PNG over GIF, such as more colors, 256 levels of transparency, and perhaps most importantly, lack of patent encumbrance. The format is a web standard and all recent popular web browsers support it.
- The GIMP Animation package now does onion-skinning, a bluescreen feature was added as well as audio support.
- A channel mixer filter, previously available from the web as an add-on, appears in Filters → Colors.

.5 What's New in GIMP 2.2?

Here is a brief summary of some of the most important new features introduced in GIMP 2.2. There are many other smaller changes that long-time users will notice and appreciate (or complain about!). There are also important changes at the level of plug-in programming and Script-Fu creating that are not covered here.

Interoperability and Standards Support

- You can drag-and-drop or copy-and-paste image data from the GIMP to any application which supports image/png drops (currently Abiword and Kword at least) and image/xml+svg drops (Inkscape supports this one). So you can copy-and-paste curves into the GIMP from Inkscape, and then drag a selection into Abiword to include it inline in your document.
- Patterns can now be any supported `GtkPixbuf` format, including png, jpeg, xbm and others.
- GIMP can load gradients from SVG files, and palettes from ACT and RIFF files.
- Drag-and-drop support has been extended. You can now drop files and URIs onto an image window, where they will be opened in the existing image as new layers.

Note



Please note, that Drag and Drop will not work for Apple Mac OS X between GIMP and the finder. This is due to a lack of functionality on Apples X11.app

Shortcut Editor You can now edit your shortcuts in a dedicated dialog, as well as continue to use the little-known dynamic shortcuts feature (which has been there since 1.2).

Plug-in Previews We have provided a standard preview widget for plug-in authors which greatly reduces the amount of code required to support previews. David Odin has integrated this widget into all the current filters, so that now many more filters in the GIMP include a preview which updates in real time, and the various previews behave much more consistently.

Real-Time Previews of Transform Operations The transform tools (shear, scale, perspective and rotate) can now show a real-time preview of the result of the operation when the tool is in “Traditional” mode. Previously, only a transforming grid was shown.

GNOME Human Interface Guide Conformance A lot of work has been done on making the GIMP’s interface simpler and more usable for newcomers. Most dialogs now follows the GNOME HIG to the best of our knowledge. In addition, dialogs have separated out or removed many “Advanced” options, and replaced them with sane defaults or hidden them in an expander.

GTK+ 2.4 Migration

- Menus use the `GtkUIManager` to generate menu structure dynamically from XML data files.
- A completely revamped File Chooser is used everywhere in the GIMP for opening or saving files. The best thing about it is that it lets you create a set of “bookmarks”, making it possible to navigate quickly and easily to commonly used directories.

- GIMP now supports fancy ARGB cursors when they are available on the system.

Basic Vector Support Using the GFig plug-in, the GIMP now supports the basic functionality of vector layers. The GFig plug-in supports a number of vector graphics features such as gradient fills, Bezier curves and curve stroking. It is also the easiest way to create regular or irregular polygons in the GIMP. In the GIMP 2.2, you can create GFig layers, and re-edit these layers in GFig afterwards. This level of vector support is still quite primitive, however, in comparison to dedicated vector-graphics programs such as Inkscape.

Also . . . There are many other smaller user-visible features. A rapid-fire list of some of those features is below.

- It is now possible to run the GIMP in batch mode without an X server.
- We have a GIMP binary (GIMP-console) which is not linked to GTK+ at all.
- Improved interface for extended input devices
- Editable toolbox: You can now decide which tools should be shown in the Toolbox, and their order. In particular, you can add any or all of the Color Tools to the Toolbox if you wish to.
- Histogram overlays R, G and B histograms on the Value histogram, and calculates the histogram only for the contents of the selection.
- Shortcuts are now shared across all GIMP windows.

.6 What's New in GIMP 2.4?

Refreshed Look A whole new default icon theme has been created for 2.4. The icons comply with the Tango style guidelines so GIMP doesn't feel out of place on any of the supported platforms. Regardless of whether you run GIMP under Microsoft Windows, Mac OS X or Linux (GNOME, KDE or Xfce), GIMP provides a polished, consistent look.

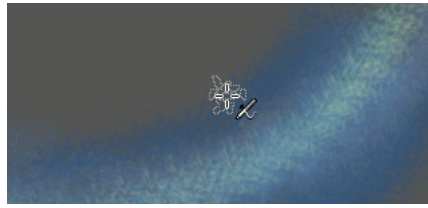
Figure 429 New Look of the toolbox in GIMP 2.4



Additionally the icons also have enhanced usability on dark widget themes, which is a common setting among digital artists.

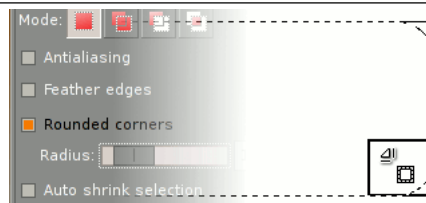
For artists preferring more desaturated color theme for their icons is an alternative icon theme available for download (download not available anymore).

Scalable Brushes The tool options now include a brush size slider that affects both the parametric and bitmap brushes. This has been an oft-requested feature from both digital painters and photo editors.

Figure 430 Scalable brushes in GIMP 2.4

Unlike previous versions of GIMP, regardless of whether you're using a bitmap brush, parametric brush or even a picture tube (multiple bitmaps), you can easily set the brush size with either the tool options dock slider or an external device such as a MIDI slider or knob or a USB device like the Griffin Powermate.

Selection Tools The selection tools have been rewritten from scratch to allow resizing of existing selections. Additionally the rectangular selection tool includes a setting for creating rounded corners as this has been identified as a very common task among web designers.

Figure 431 Selection tools in GIMP 2.4

The learning curve for the tools has been flattened as the key functionality is available without obscure shortcuts that confused GIMP beginners. Most of the existing shortcuts still work, but the functionality is either available through the tool options or made obsolete due to the interactive move and resize on canvas.

While the tools have been redesigned to make them easier to understand for the newbies, all the former functionality is there. You can still constrain aspect ratios or specific sizes.

Foreground Select Tool Selecting individual objects on images is easier now with a new **foreground select tool**. It is done in two steps. First, you make select region of interest which contains the entire object. Then you paint over selected area with a brush, not crossing object's border. Release mouse button when you're done and look, if there are dark blue spots on your objects. If there are some, paint with a brush over them again and release to refine selection. When there are no more blue areas inside the object, press Enter and there you have a perfectly selected object.

Align Tool While GIMP has provided a grid and guideline functionality, the actual alignment of objects had to be done manually. A new tool comes at rescue ...

Changes in menus Most notable is the new top-level Color menu that accumulates most tools, plug-ins and scripts that adjust colors in RGB/Grayscale mode and color palettes in Indexed mode. So now you can reach functions like Levels or Curves much faster than before, unless you define your own keyboard shortcuts for them using the improved keyboard shortcuts manager.

In the new version of GIMP, some menu entries have changed their names and position. It was done mostly to simplify learning curve and improve user experience. After all, "HSV Noise" and "RGB Noise" sound more meaningful than "Scatter HSV" and "Scatter RGB", don't they? And status bar hints for all plug-ins and scripts are quite helpful too.

Support for file formats

- Support for Photoshop ABR brush format;
- Improved reading/writing EXIF in JPEG;
- Importing clipping paths in TIFF;
- Layer masks can be saved to PSD;

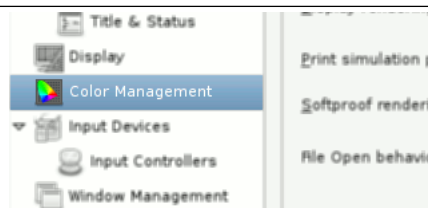
- 16/32 bit bitmaps and alpha-channel support in BMP;
- 24 bit and Vista icons can be opened and saved.

Fullscreen Editing The fullscreen mode has been improved to not only allow getting a full scale preview of the artwork, but also allow comfortable editing. The artist has maximum screen estate available while all functionality is quickly accessible by pressing the **Tab** key (toggles visibility of all docks) when working fullscreen.

Whether painting or touching up photos, fullscreen editing keeps all the distracting elements out of sight on a key press. It's like observing stars in a field as opposed to a light-polluted city.

Color Management and Soft-proofing GIMP now provides full support for color profiles allowing precise color modification throughout the whole "digital darkroom" process.

Figure 432 Color management in GIMP 2.4



New Crop Tool Just like the selection tools, the new crop tool has been enhanced since the last release. The resize handles actually resize the crop rectangle instead of providing both resize and move functionality. The tool behaves more naturally and consistently with other GIMP tools. For details see Section [14.4.4](#).

To move, simply drag the rectangle clicking within the area. Resizing is possible in one or two axes at the same time dragging the handle-bars on the sides and corners. The outside area is darkened with a nice passepartout effect to better get the idea of how the final crop will look like.

Red Eye Removal While numerous red-eye workflows exist already, GIMP now features a very convenient auto-magic filter to remove red eye from your shots.

Healing Brush The healing brush is a new tool, similar in the working of the clone tool, that permits to quickly fix small defects or imperfections due to scratching or dust. In fact the tool is smart enough to being able to *understand* where and how to modify an image to cure these defects based on image color context.

Perspective Clone Here is another clone-like new tool that is able to adapt the destination geometry, instead of color as does the healing brush, based on preselected distortion settings. As the name suggests, perfect when copying images blocks with some type of prospective changes.

Lens Distortion A very common problem exposing itself especially when using cheaper lenses is barrel distortion and vignetting. Luckily GIMP provides a brand new filter to compensate for both problems. Saving photographer's pocket is our mission!

Various Other Improvements In addition to all the above, GIMP has been improved in other areas such as:

- Better status information for tools in the window status bar.
- Various speedups in composing functions and gradient drawing.
- Zoomable preview widget for plugins.

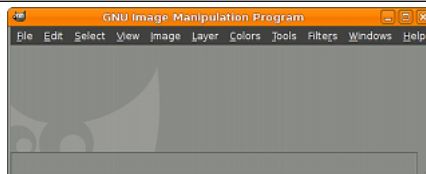
.7 What's New in GIMP 2.6?

GIMP 2.6 is an important release from a development point of view. It features changes to the user interface addressing some often received complaints, and a tentative integration of GEGL, the graph based image processing library that will eventually bring high bit-depth and non-destructive editing to GIMP.

User Interface

Toolbox Menubar removed The toolbox menubar has been removed and merged with the image window menubar. To be able to do this a window called the empty image window has been introduced. It hosts the menubar and keeps the application instance alive when no images are opened. It also acts as a drag and drop target. When opening the first image the empty image window is transformed into a normal image window, and when closing the last image, that window becomes the empty image window.

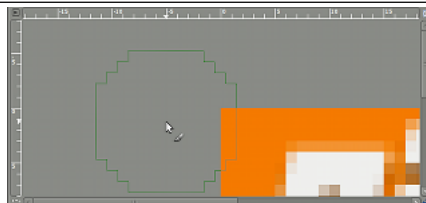
Figure 433 New Look of the image window in GIMP 2.6



Toolbox and docks are utility windows With the empty image window acting as a natural main window, the Toolbox and Docks windows are now utility windows rather than main windows. This enables window managers to do a much better job of managing the GIMP windows, including omitting the Toolbox and Docks from the taskbar and ensuring that the Toolbox and Docks always are above image windows.

Ability to scroll beyond image border The Navigation dialog now allows panning beyond the image border; so it is no longer a problem to use a brush on the edge of an image that fills the entire display window. Also, if a utility window covers the image, you can pan the image to view or edit the portion covered by the utility window.

Figure 434 Scrolling beyond border



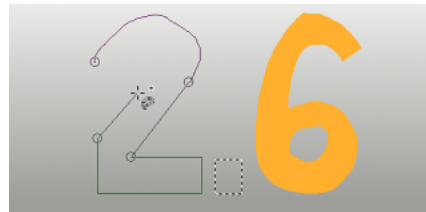
Minor changes

- Renamed Dialogs menu to Windows.
- Keep a list of recently closed Docks and allow reopening them.
- Make opening images in already running GIMP instances work better on Windows.
- You can now enter the image zoom ratio directly in the status bar.
- Added support for using online help instead of a locally installed GIMP Help package.
- Make it possible to lock tabs in docks to prevent accidental moving.

Tools, Filters and Plug-ins

Improved Free Select Tool The freehand select tool has been enhanced to support polygonal selections. It also allows mixing free hand segments with polygonal segments, editing of existing segments, applying angle-constraints to segments, and of course the normal selection tool operations like add and subtract. Altogether this ends up making the Free Select Tool a very versatile, powerful and easy-to-use selection tool.

Figure 435 Polygonal Selection



Brush Dynamics Brush dynamics uses an input dynamic such as pressure, velocity, or random, to modify brush parameters such as opacity, hardness, size, or color; every brush supports size and opacity, most support more. Velocity and random are usable with a mouse. The Ink tool, that supported velocity, has been overhauled to better handle velocity-dependent painting.

Figure 436 Brush Dynamics

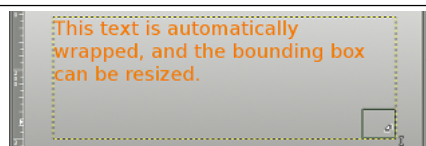


Brush dynamics have enabled a new feature in stroking paths. There is now a check box under the “paint tool” option, for emulating brush dynamics if you stroke using a paint tool. What this means is that when your stroke is painted, GIMP tells the brush that the pressure and velocity are varying along the length of the stroke. Pressure starts with no pressure, ramps up to full pressure, and then ramps down again to no pressure. Velocity starts from zero and ramps up to full speed by the end of the stroke.

Minor changes

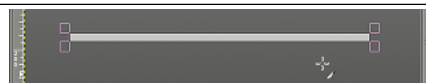
- Added a bounding box for the Text Tool that supports automatic wrapping of text within that bounding box.

Figure 437 Text tool bounding box



- Move handles for rectangle based tools like Crop and Rectangle Select to the outside of the rectangle when the rectangle is narrow.

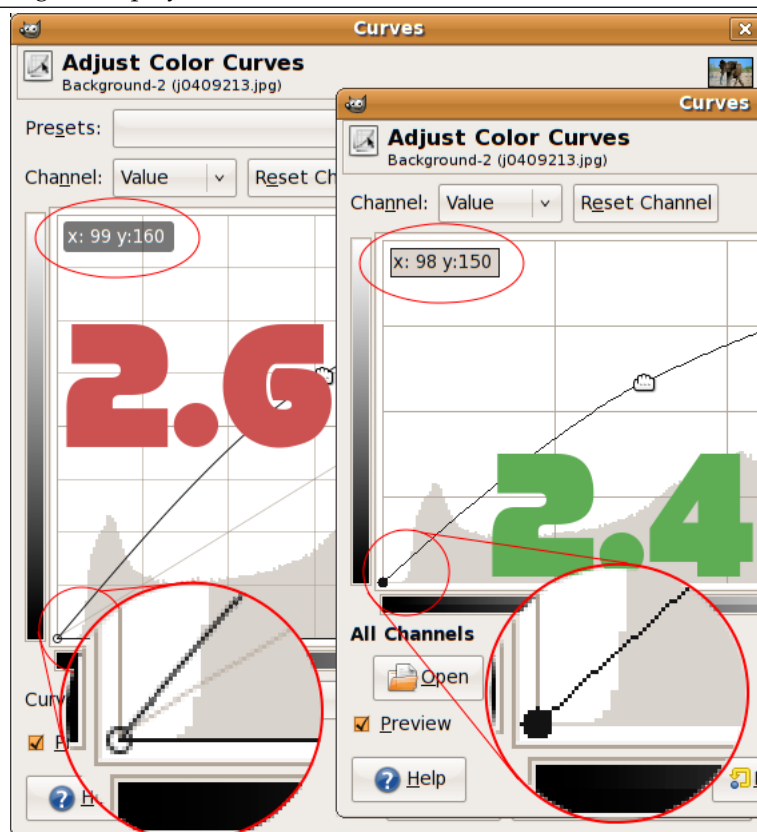
Figure 438 Rectangle handles



- Added motion constraints to the Move Tool.
- Improved event smoothing for paint tools.
- Mark the center of rectangles while they are moved, and snap the center to grid and rulers.
- Enable brush scaling for the Smudge tool.
- Added ability to save presets in all color tools for color adjustments you use frequently.

- Allow to transfer settings from *Brightness-Contrast* to *Levels*, and from *Levels* to *Curves*.
- Allow changing opacity on transform tool previews.
- The Screenshot plug-in has been given the ability to capture the mouse cursor (using Xfixes).
- Display aspect ratio of the Crop and Rectangle Select Tool rectangles in the status bar.
- Desaturate has been given an on-canvas preview.
- The Flame plug-in has been extended with 22 new variations.
- Data file folders like brush folders are searched recursively for files.
- Replaced the PSD import plug-in with a rewritten version that does what the old version did plus some other things, for example reading of ICC color profiles.
- Several displays use Cairo library.

Figure 439 Comparing 2.6 display vs 2.4

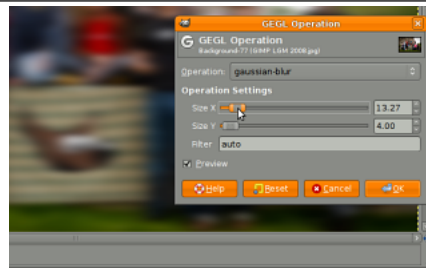


Under the Hood

GEGL Important progress towards high bit-depth and non-destructive editing in GIMP has been made. Most color operations in GIMP are now ported to the powerful graph based image processing framework GEGL [GEGL], meaning that the internal processing is done in 32bit floating point linear light RGBA. By default the legacy 8bit code paths are still used, but a curious user can turn on the use of GEGL for the color operations with "Colors / Use GEGL".

In addition to porting color operations to GEGL, an experimental GEGL Operation tool has been added, found in the Tools menu. It enables applying GEGL operations to an image and it gives on-canvas previews of the results. The screenshot below shows this for a Gaussian Blur.

Figure 440 GEGL operation



Minor changes Ported many widgets to use the 2D graphics library cairo [[CAIRO](#)] for drawing. See this [comparison](#) for an example of how much better this looks.

Miscellaneous

Plug-in Development There are new things for a plug-in developer to enjoy as well. For example, procedures can now give a detailed error description in case of an error, and the error can be propagated to the user.

GIMP 2.6 also further enhances its scripting abilities. In particular there is now a much richer API for the creation and manipulation of text layers. Here is a list of new symbols in GIMP 2.6: [[GIMP-NEWSYM26](#)].

Backwards Compatibility Some old scripts could not be used with GIMP-2.4. This has been improved and 2.6 should run 2.0 and 2.2 scripts.

Known Problems

- The Utility window hint is currently only known to work well in the Linux GNOME desktop environment and on Windows starting with GIMP 2.6.1.
- Using the Text Tool is currently not an optimal experience. Making it work better is a goal for GIMP 2.8.
- If you build GIMP yourself and don't have GVfs support on your platform you need to explicitly pass `--without-gvfs` to **configure**, otherwise opening remote files will not work properly.

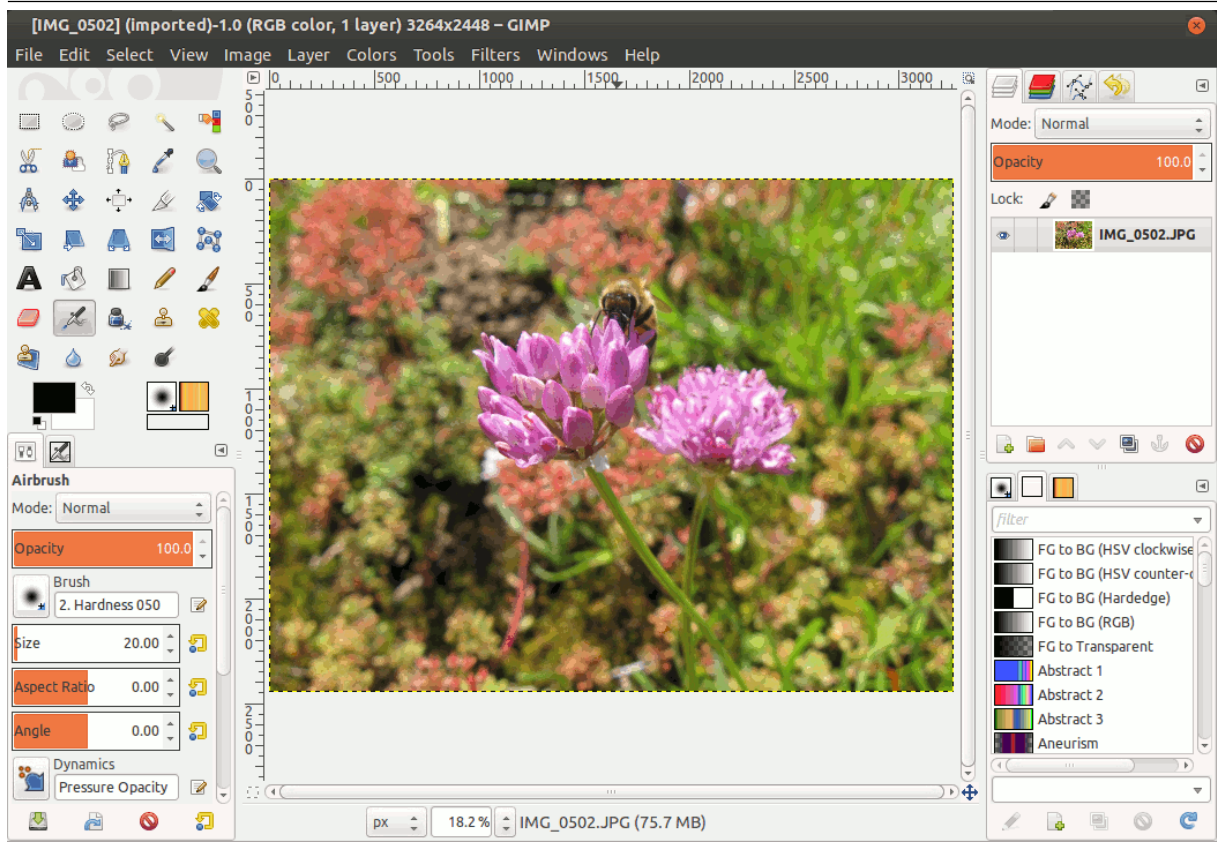
.8 What's New in GIMP 2.8?

GIMP 2.8 is another important release from a development point of view, even more that it was for 2.6. It features a big change to the user interface addressing one of the most often received complaints: the lack of a single window mode. Moreover the integration effort of GEGL library had taken a big step forward, reaching more than 90% of the GIMP core, a new powerful transformation tool, layer groups, new common options, new brushes, improved text tool, and more.

User Interface

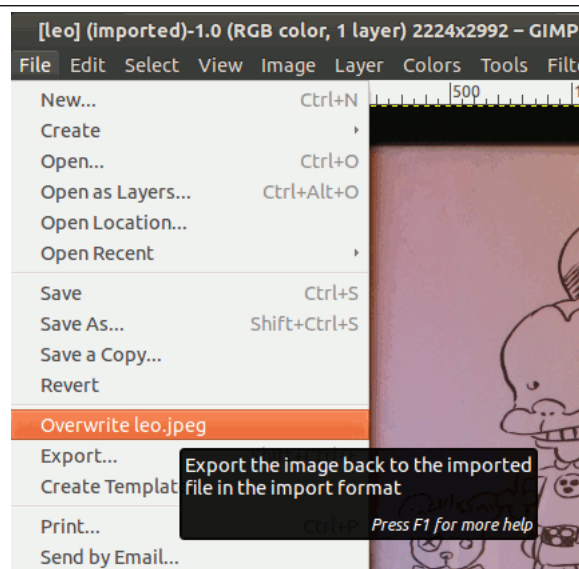
New single window mode With this new feature it will be possible to work with all the GIMP dialogs inside one big window, usually with the image(s) centered inside. No more floating panels or toolbox but the dialogs could be arranged inside this single window. This mode could be enabled or disabled all the time, even while working, and the option will be remembered through the sessions.

Figure 441 The new look of the single window mode



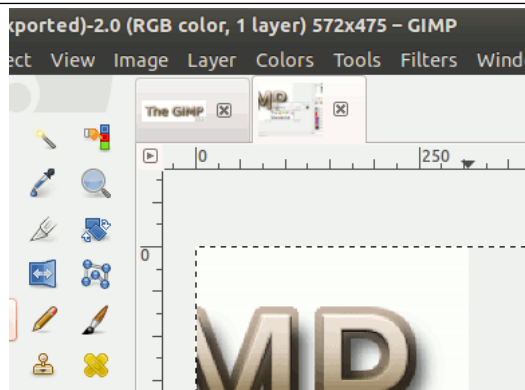
New file save workflow Now Save and Save as work only with xcf formats. If you want to export an image in another format, say jpg or png, you have to explicitly Export it. This enhances the workflow and lets you simply overwrite the original file or export to various other formats.

Figure 442 The new image workflow



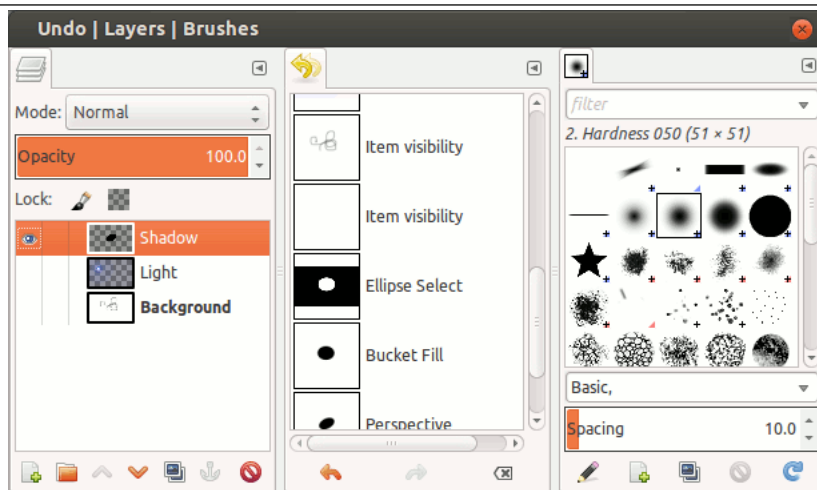
New image bar A new useful image bar comes with the single window mode, which lets you switch easily between open images through the means of a tab bar with image thumbnails.

Figure 443 The new image bar



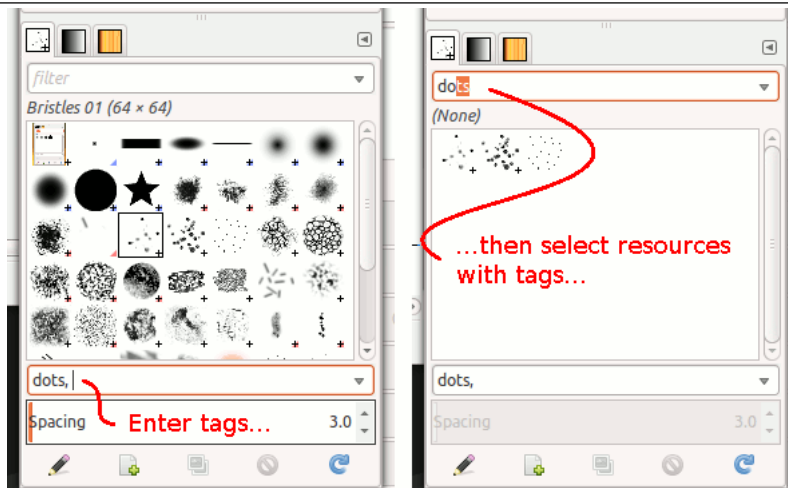
New arrangement options GIMP will make users working with two screens (one for dialogs, the other for images) happy: now it is possible to arrange the dialogs one over the other, in tabs and in columns too.

Figure 444 Multi column docks



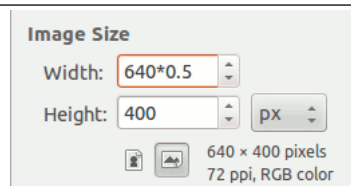
New resources tags GIMP Brushes, Gradients, Pattern and Palettes can be filtered and searched via tags. Tags are text labels that the user can assign to resources. With Tags the user can easily find the resources by means of an input text box. Tags can be manually assigned by the user with the same input box used for searching tags, or they can be automatically tagged using the directory name of the imported items.

Figure 445 Resource tags



Simple math in size entries Enhancements have also been made to the size entry widget, which is used for inputting most of the x, y, width, height parameters. For example, in the scale dialog it is now possible to write "50%" in the Width field to scale the image to 50% of the width. Expressions such as "30in + 40px" and "4 * 5.4in" work, too.

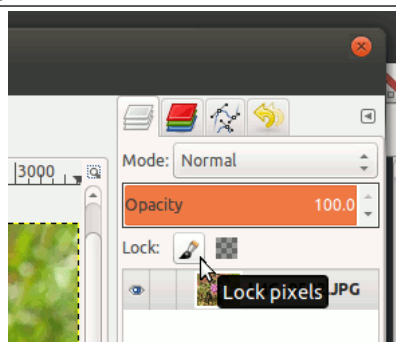
Figure 446 Math size entries



Minor changes

- The new "Lock Pixels" option in the layers dialog can avoid undesired painting on a layer when working with several layers.

Figure 447 The new Lock Pixels option



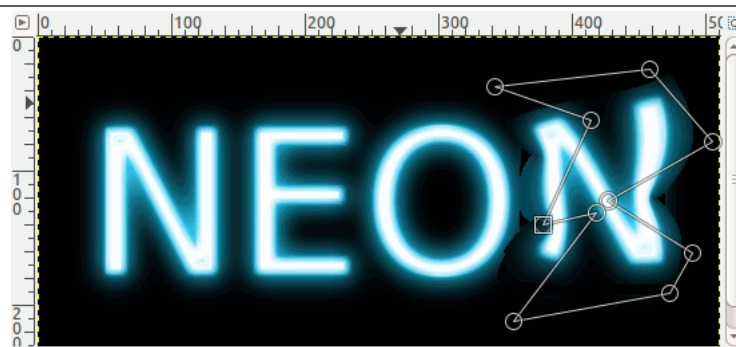
- Now you can move between images in single and multi window mode using the shortcuts Ctrl-Page Up/Page Down or Alt-Number.
- Add support for F2 to rename items in lists.
- You can now Alt-Click on layers in the Layers dialog to create a selection from it. Add, subtract and intersect modifiers **Click**, **Shift** and Ctrl-Shift keys work too. This makes it easy to compose contents of a layer based on the contents of other layers, without detours.
- Since the keyboard shortcuts Ctrl-E and Ctrl-Shift-E have been redirected to image export mechanisms, new keyboard shortcuts have been setup for "Shrink Wrap" and "Fit Image in Window", namely Ctrl-J and Ctrl-Shift-J respectively.

- Added Windows → Hide docks menu item that does what “Tab” does and also displays its state, which is now persistent across sessions, too.
- The layer modes have been rearranged into more logical and useful groups based on the effect they have on layers. Layer modes that make the layer lighter are in one group, layer modes that make the layer darker in another group, and so forth.
- In multi-window mode, you can now close the Toolbox without quitting GIMP.
- Allow binding arbitrary actions to extra mouse buttons.
- Now it is possible to change the application language directly from the preference menu.

Tools, Filters and Plug-ins

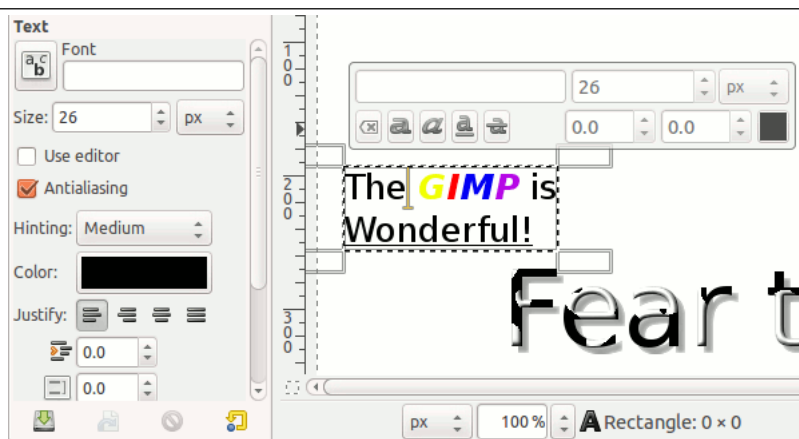
A new tool: Cage Transform With this new tool is now possible to create custom bending of a selection just moving control points. This is the result of one of our Google Summer of Code 2010 students.

Figure 448 Cage Transform



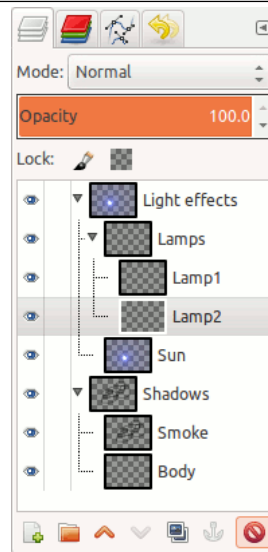
Improved Text Tool The text tool has been enhanced to support on canvas text writing and make possible changing the attributes of a single char.

Figure 449 Improved text tool



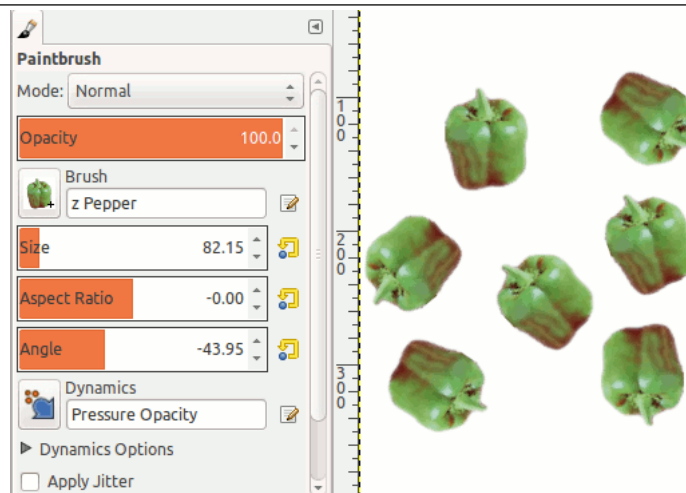
New layer groups It is now possible to group set of layers and treat them like an entity. It is possible to switch a group on or off and to move the group in the layers dialog. It is easy to add / remove existing layers to a group or to create / delete a layer inside the group and it is even possible to create embedded groups of groups. It is possible to apply a layer mode to a group as you do with a single layer. All this greatly improves the workflow with complex multilayer images making them easier to manage.

Figure 450 New layer groups



Rotating brushes Brushes can now be rotated at will, acting on the brush option “Angle”.

Figure 451 Rotating brushes



Minor changes

- The default Quick Mask color is now configurable.
- The RTL mode (right to left writing) has been improved in the Text tool.
- You can specify the written language in the Text Tool. This helps choosing an appropriate font, or appropriate glyphs for the selected language.
- Added optional diagonal guides to the crop tool.
- Added “Rule of fifths” crop guide overlay.
- A Cairo based PDF exporter has been implemented. Although being somewhat simplistic, the exporter saves text, embedding fonts into the final PDF file, and attempts to convert bitmaps to vector objects.
- Brush dynamics improved.
- Added plug-in for loading JPEG2000 images.
- Added plug-ins for X11 Mouse Cursor import and export support.
- Added fundamental OpenRaster (.ora) import and export support.
- Added RGB565 support to the csource plug-in.

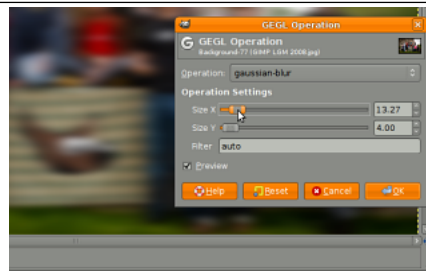
- Added a new “Create” command that allows loading a Web page directly into GIMP using Webkit.

Under the Hood

GEGL The porting of the GIMP core towards the new high bit-depth and non-destructive editing GEGL [GEGL] library has taken big steps and now more than 90% of the task is already finished.

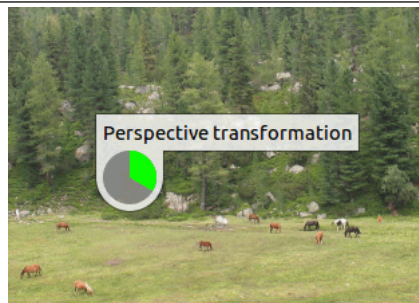
In addition to porting color operations to GEGL, an experimental GEGL Operation tool has been added, found in the Tools menu. It enables applying GEGL operations to an image and it gives on-canvas previews of the results. The screenshot below shows this for a Gaussian Blur.

Figure 452 GEGL operation



Cairo porting Started with GIMP version 2.6, all tools rendering on canvas is now completely ported to [CAIRO]. It provides smooth antialiased graphics and improves GIMP look. Some plug-ins have been upgraded to Cairo as well. Additionally all tools now use an on-canvas progress indicator instead of the one in the statusbar.

Figure 453 Progress indicator



Miscellaneous

License change The GIMP license has been changed to (L)GPLv3+.

New script API

- A lot of GIMP APIs have been rebuilt to simplify developing new scripts.
- To further enhances scripting abilities, API changes to support layer groups have been made.

Backwards Compatibility To allow migrating from the old tools presets system to the new one, there is a Python **script**, which you can download from the GIMP wiki site. However, the old tools presets are not 100% convertible to the new tool presets. For instance, brush scale from 2.6 can't be converted to brush size in 2.8.

Known Problems Working with graphics tablets could be problematic due to the GTK+2 library in use. If in this case either use the older version 2.6 or wait for the up coming version 3.0 for the full GTK+3 support.

.9 What's new in GIMP 2.10?

GIMP 2.10 is the result of six years of work that originally focused on porting the program to a new image processing engine, GEGL. However the new version ships with far more new features, including new and improved tools, better file formats support, various usability improvements, revamped color management support, a plethora of improvements targeted at digital painters and photographers, metadata editing, and much, much more.

Updated user interface and initial HiDPI support

One thing immediately noticeable about GIMP 2.10 is the new dark theme and symbolic icons enabled by default. This is meant to somewhat dim the environment and shift the focus towards content.

There are now 4 user interface themes available in GIMP: *Dark* (default), *Gray*, *Light*, and *System*. Icons are now separate from themes, and we maintain both color and symbolic icons, so you can configure GIMP to have *System* theme with color icons if you prefer the old look.

Moreover, icons are available in four sizes now, so that GIMP would look better on HiDPI displays. GIMP will do its best to detect which size to use, but you can manually override that selection in Edit → Preferences → Interface → Icon Themes.

Contributors: Benoit Touchette, Klaus Staedtler, Ville Päätsi, Aryeom Han, Jehan Pagès, Alexandre Prokoudine...

GEGL port, high bit depth support, multi-threading, and more

The ultimate goal for v2.10 was completing the port to GEGL image processing library, started with v2.6 when we introduced optional use of GEGL for color tools and an experimental GEGL tool, and continued with v2.8 where we added GEGL-based projection of layers.

Now GIMP uses GEGL for all tile management and builds an acyclic graph for every project. This is a prerequisite for adding non-destructive editing planned for v3.2.

There are many benefits from using GEGL, and some of them you can already enjoy in GIMP 2.10.

High bit depth support allows processing images with up to 32-bit per color channel precision and open/export PSD, TIFF, PNG, EXR, and RGBE files in their native fidelity. Additionally, FITS images can be opened with up to 64-bit per channel precision.

Multi-threading allows making use of multiple cores for processing. Not all features in GIMP make use of that, it's something we intend to work on further. A point of interest is that multi-threading happens through GEGL processing, but also in core GIMP itself, for instance to separate painting from display code.

GPU-side processing is still optional, but available for systems with stable OpenCL drivers.

You can find configuration options for multi-threading and hardware acceleration in Edit → Preferences → System Resources.

Contributors: Michael Natterer, Øyvind Kolås, Ell, Jehan Pagès...

Linear color space workflow

Another benefit of using GEGL is being able to work on images in a linear RGB color space as opposed to gamma-corrected (perceptual) RGB color space.

Here is what it boils down to:

- You now have both linear and perceptual versions of most blending modes.
- There is now a linear version of the `_Color Invert_` command.
- You can freely switch between the two at any time via Image → Precision submenu.
- You can choose which mode is displayed in the *Histogram* docker.
- You can apply *Levels* and *Curves* filters in either perceptual or linear mode.
- When higher than 8-bit per channel precision is used, all channels data is linear.
- You can choose whether the gradient tool should work in perceptual RGB, linear RGB, or CIE LAB color space.

Contributors: Michael Natterer, Øyvind Kolås, Ell...

Color management revamped

Color management is now a core feature of GIMP rather than a plug-in. This made it possible, in particular, to introduce color management to all custom widgets we could think of: image previews, color and pattern previews etc.

GIMP now uses LittleCMS v2, which allows it to use ICC v4 color profiles. It also partially relies on the babl library for handling color transforms, since babl is simply up to 10 times faster than LCMS2 for the cases we tested both of them on. Eventually babl could replace LittleCMS in GIMP.

Contributors: Michael Natterer, Øyvind Kolås...

Layers and masks

GIMP now ships with two groups of blending modes: legacy (perceptual, mostly to make old XCF files look exactly as before) and default (mostly linear).

New blend modes are:

- LCH layer modes: *Hue*, *Chroma*, *Color*, and *Lightness*.
- *Pass-Through* mode for layer groups.
- *Linear Burn*, *Vivid Light*, *Linear Light*, *Pin Light*, *Hard Mix*, *Exclusion*, *Merge*, and *Split*.

Layers, paths, and channels can also be tagged with color labels to improve project organization. This will be even more useful once we add multi-layer selection later on.

Compositing options for layers are exposed to users now, and all layer-related settings are finally available in the *Layer Attributes* dialog.

Moreover, if you always need alpha in your layers, you can enable automatic generation of the alpha channel in imported images upon opening them. See Edit → Preferences → Image Import & Export page for this and more policies.

Layer groups can finally have masks on:

More use for CIE LAB and CIE LCH

With GIMP 2.10, we introduced a number of features that make use of CIE LAB and CIE LCH color spaces:

- Color dialogs now have an LCH color selector you can use instead of HSV. The LCH selector also displays out-of-gamut warning.
- A new *Hue-Chroma* filter in the *Colors* menu works much like *Hue-Saturation*, but operates in CIE LCH color space.
- The *Fuzzy Select* and the *Bucket Fill* tools can now select colors by their values in CIE *L*, *C*, and *H* channels.
- Both the *Color Picker* and the *Sample Points* dialog now display pixel values in CIE LAB and CIE LCH at your preference.

Contributors: Michael Natterer, Elle Stone, Ell...

New and improved tools

Unified Transform New *Unified Transform* tool (Shift-L) simplifies making multiple transforms, such as scaling, rotating, and correcting perspective in one go. The design is based on a functional spec written by our former UX expert Peter Sikking.

Contributors: Mikael Magnusson, Michael Natterer...

Warp Transform The new *Warp Transform* tool (W) allows doing localized transforms like growing or shifting pixels with a soft brush and undo support. Such tools are commonly used in fashion photography for retouching.

As such, the new tool retires the old *iWarp* filter that was innovative at the time of its inception (and pre-dated Photoshop's *Liquify* filter), but was ultimately cumbersome to use. The *Warp Transform* tool also features an Eraser mode to selectively remove changes, previously unavailable in the *iWarp* filter.

Contributors: Michael Muré, Michael Natterer, Jonathan Tait...

Handle Transform The new *Handle Transform* tool (Shift-L) provides an interesting approach at applying scaling, rotating, and perspective correction using handles placed on the canvas. People who are used to editing on touch surfaces might find this tool strangely easy to grasp.

Contributors: Johannes Matschke, Michael Natterer, Ell...

Blend tool becomes Gradient tool and gets on-canvas editing We renamed the *Blend* tool to *Gradient* tool and changed its default shortcut to **G**. But this pales in comparison to what the tool can actually do now, and it's a lot.

The new tool pretty much obsoletes the old *Gradient Editor* dialog. Now you can create and delete color stops, select and shift them, assign colors to color stops, change blending and coloring for segments between color stops and create new color stops from midpoints *right on the canvas*.

All gradients available by default are also "editable" now. What it means is that when you try to change an existing gradient from a system folder, GIMP will create a copy of it, call it a *Custom Gradient* and preserve it across sessions. Unless, of course, you edit another 'system' gradient, in which case it will become the new custom gradient.

We intend to use the generic implementation of this later for brushes and other types of resources.

Contributors: Michael Henning, Michael Natterer, Ell, Øyvind Kolås...

Better selection tools The *Foreground Select* tool can finally make subpixel selections in complex cases such as strays of hair on textured background. Two new masking methods are now available for that.

The *Select by Color* and *Fuzzy Select* tools now both feature a Draw mask option to display future selection area with a magenta fill, and the latter tool also got a Diagonal neighbors option to select diagonally neighboring pixels.

For the *Free Select* tool, closing a polygonal/free selection now doesn't confirm the selection automatically. Instead you still can tweak positions of nodes (where applicable), then press **Enter**, double-click inside the selection, or switch to another tool to confirm the selection.

The *Intelligent Scissors* tool finally allows to remove the last added segment with **Backspace** key, and GIMP now checks, whether the first and the last segments are distinct before closing the curve.

Contributors: Michael Natterer, Jan Rüeegg, Daniel Sabo, Ell...

Color tools All color tools have been refactored to become GEGL-based filters, so they could be properly used later on when we introduce non-destructive editing. Hence, the *Color* submenu in the *Tools* menu has been removed, and these filters are now mostly unavailable in the toolbox.

Contributors: Michael Natterer...

Text tool supports CJK and more writing systems The *Text* tool now fully supports advanced input methods for CJK and other non-western languages. The pre-edit text is now displayed just as expected, depending on your platform and input method engine (IME). Several input method-related bugs and crashes have also been fixed.

Contributors: Jehan Pagès...

Experimental tools Two new tools were incomplete for inclusion to GIMP 2.10 by default, but still can be enabled. Please note that they are highly experimental and likely to be broken for you (up to have GIMP crash). We only mention them, because we need contributors to get them into the releasable state.

N-Point Deformation tool introduces the kind of smooth, as little rigid as possible warping you would expect physical objects to have.

The *Seamless Clone* tool is aimed to simplify making layered compositions. Typically when you paste one image into another, there are all sorts of mismatches: color temperature, brightness etc. This new experimental tool tries to adapt various properties of a pasted image with regards to its backdrop.

To enable these tools, you need to first enable the *Playground* page of the *Preferences* dialog. Do it by running GIMP with a **--show-playground** switch (for Windows, you might want tweaking the path to GIMP in the shortcut properties accordingly). Then you need to go to Edit → Preferences → Playground and enable the respective options, so that the tools would show up in the toolbox.

We need to stress again that you should only do so either if you are very curious, or (which we hope for) intend to help us fix them.

Contributors: Marek Dvorožnak, Barak Itkin, Jehan Pagès, Michael Natterer...

Digital painting improvements

GIMP 2.10 ships with a number of improvements requested by digital painters. One of the most interesting new additions here is the *MyPaint Brush* tool (Y) that first appeared in the GIMP-Painter fork.

The *Smudge* tool got updates specifically targeted in painting use case. The new No erase effect option prevents the tools from changing alpha of pixels. And the foreground color can now be blended into smudged pixels, controlled by a new Flow slider, where 0 means no blending.

All painting tools now have explicit Hardness and Force sliders except for the *MyPaint Brush* tool that only has the Hardness slider.

Most importantly, GIMP now supports canvas rotation and flipping to help illustrators checking proportions and perspective.

A new Brush lock to view option gives you a choice whether you want a brush locked to a certain zoom level and rotation angle of the canvas. The option is available for all painting tools that use a brush except for the *MyPaint Brush* tool.

New *Symmetry Painting* dockable dialog, enabled on per-image basis, allows to use all painting tools with various symmetries (mirror, mandala, tiling...).

This new version of GIMP also ships with more new brushes available by default.

Contributors: Michael Natterer, Alexia Death, Daniel Sabo, shark0r, Jehan Pagès, Ell, Jose Americo Gobbo, Aryeom Han...

Digital photography improvements

Some of the new GEGL-based filters are specifically targeted at photographers: *Exposure*, *Shadows-Highlights*, *High-pass*, *Wavelet Decompose*, *Panorama Projection* and others will be an important addition to your toolbox.

On top of that, the new *Extract Component* filter simplifies extracting a channel of an arbitrary color model (LAB, LCH, CMYK etc.) from currently selected layer. If you were used to decomposing and recomposing images just for this, your work will be that easier now.

Moreover, you can now use either *darktable* or *RawTherapee* as GIMP plug-ins for opening raw digital photos. Any recent version of either application will do.

A new *Clip Warning* display filter will visualize underexposed and overexposed areas of a photo for you, with customizable colors. For now, it's mostly geared towards images where colors are stored with floating point precision. You will mostly benefit from this if you work on 16/32 bit per channel float images such as EXR and TIFF.

Contributors: Michael Natterer, Ell, Thomas Manni, Tobias Ellinghaus, Øyvind Kolås, Jehan Pagès, Alberto Griggio...

Effects

GIMP now ships with over 80 GEGL-based filters. A lot of those are former GIMP effects. Here is why GEGL-based implementations are better:

- You can apply them on images in 32-bit per color channel precision mode.
- You can preview them right on the canvas, and if an image is larger than the viewport, GIMP will render the viewport first for immediate feedback.
- You can use split preview to compare original image with its processed version and swap before/after sides both horizontally and vertically.
- In a future non-destructive GIMP, you will be able to adjust settings of those filters without undoing a ton of steps.

Some of the GEGL-based filters have OpenCL version for hardware acceleration. This will come in handy, if OpenCL drivers work well for you. Furthermore many operations can come multi-threaded to use your processor at their full power.

Contributors: Michael Natterer, Øyvind Kolås, Thomas Manni...

Usability improvements

While working with active users, we got rid of quite a few usability issues. Here are just some of these changes:

- All transformation tools now automatically disable original layer view so that you could clearly see adjustments against the backdrop.
- Masks can now easily be created with last values you used by just pressing **Shift** and clicking on respective layer's preview.
- All dialogs except the ones like *Scale* now remember last values you used across sessions.
- All GEGL-based filters allow saving named presets and automatically make timestamped presets for the last time you used them.
- You can now choose fill color or pattern for empty spaces after resizing the canvas.

There is a lot to improve to make GIMP better suited for professional workflows. As usual, we welcome constructive discussion and recently created a [mailing list](#) to discuss the topic of improving GIMP's usability. This is a long-term enhancement process, which can take more time than localized changes and features.

Contributors: Michael Natterer, Daniel Sabo, Benoit Touchette, Massimo Valentini, Jehan Pagès...

File formats support

GIMP is now capable of reading and writing TIFF, PNG, PSD, and FITS files with up to 32-bit per channel precision where applicable.

The PSD plug-in additionally supports *pass-through*, *hard mix*, *pin light*, *vivid light*, and *linear light* blending modes.

GIMP now also ships with native WebP support, including features like animation, ICC profiles, and metadata. Both importing and exporting are supported.

The JPEG 2000 plug-in was rewritten to use the *OpenJPEG* library rather than the somewhat obsolete *Jasper* library.

Finally, the PDF plug-in now supports importing password-protected files (you need to know the password) and exporting multipage PDF documents (each layer will be a page).

Contributors: Michael Natterer, Mukund Sivamaran, Ell, Jehan Pagès, Lionel N, Darshan Kadu...

Metadata viewing, editing, and preservation

GIMP now ships with plug-ins for viewing and editing Exif, XMP, IPTC, GPS, and DICOM metadata. They are available via the Image → Metadata submenu.

GIMP will also preserve existing metadata in TIFF, PNG, JPEG, and WebP files. Each plug-in has respective options when exporting to enable or disable exporting the metadata.

Additionally, users now can set defaults to preserving or not preserving metadata in all affected file format plug-ins at once depending on whether they want complete privacy or, instead, do a lot of microstock photography. The settings are available on the *Image Import & Export* page in *Preferences*.

Contributors: Benoit Touchette, Michael Natterer, Jehan Pagès...

On-canvas interaction

GIMP 2.10 ships with a new feature that allows some GEGL-based filters to render on-canvas controls. For now, this applies to just three filters: *Spiral*, *Supernova*, and *Panorama Projection*. But there will be more in the future.

Contributors: Michael Natterer, Ell...

Simplified bug reporting and crash recovery

We need good bug reports to make GIMP better for you, so we introduced a new feature to watch and intercept critical errors and crashes, then generate a useful error log that you can copy/paste to a bug report.

On development versions, the dialog will be raised on all kind of errors (even minor ones). On stable releases, it will be raised only during crashes. The default behavior can be customized in Edit → Preferences → Debugging.

Please note that we still need you to provide context, e.g. what you were doing when a crash occurred. A step-by-step description of how to reproduce this bug will be most helpful.

Additionally, in case of a crash, GIMP will now attempt to backup all images with unsaved changes, then suggest to reopen them the next time you start the application.

We cannot guarantee 100% success, but it will succeed sometimes, and this might rescue your unsaved work!

Contributors: Jehan Pagès...

API changes

Over the course of this development cycle, we deprecated a lot of API, providing a compatibility layer for 3rd party developers who write scripts and plug-ins.

For the full list of changes in PDB, please [see the wiki](#). This ChangeLog page also has a verbose list of all other changes in 2.10.

Roadmap and what's next

We maintain a [roadmap for GIMP development](#) that outlines the order of features to be implemented based on priorities.

The next big update will be v3.0 that will feature GTK+3 port and a lot of internal changes. For users, this will mostly mean: updated user interface, better support for graphic tablets, better support for HiDPI displays, better support for Wayland on Linux.

We are also opening the 2.10.x series for new features. This means you don't have to wait for exciting improvements for years anymore: any new feature can indeed be backported to a 2.10.x release as long as its code is not too invasive and making maintenance difficult.

All the new features from 2.10.x will be part of 3.0 as well.

Part VIII

Reporting Bugs and Requesting Enhancements

Sad to say, no version of GIMP has yet been absolutely perfect. Even sadder, it is likely that no version ever will be. In spite of all efforts to make everything work, a program as complicated as GIMP is bound to screw things up occasionally, or even crash.

But the fact that bugs are unavoidable does not mean that they should be passively accepted. If you find a bug in GIMP, the developers would like to know about it so they can at least try to fix it.

Suppose, then, that you have found a bug, or at least think you have: you try to do something, and the results are not what you expect. What should you do? How should you report it?

Tip



The procedure for making an *enhancement request*—that is, for asking the developers to add a missing feature—is the same as the procedure for reporting a bug.

In common with many other free software projects, GIMP uses a bug-reporting mechanism called *GitLab*. This is a very powerful web-based system, capable of managing thousands of bug reports without losing track. In fact, GIMP shares its GitLab database with the entire Gnome project.

.10 Making sure it's a Bug

The first thing you should do, before reporting a bug, is to make an effort to verify that what you are seeing really *is* a bug. It is hard to give a method for doing this that applies to all situations, but reading the documentation will often be useful, and discussing the question on IRC or a mailing list may also be quite helpful. If you are seeing a *crash*, as opposed to mere misbehavior, the odds that it is a true bug are pretty high: well written software programs are not designed to crash under *any* circumstances. In any case, if you have made an conscientious effort to decide whether it is really a bug, and at the end still aren't sure, then please go ahead and report it: the worst that can happen is that you will waste a bit of time for the development team.

Note



Actually there are a few things that are known to cause GIMP to crash but have turned out to be too inconvenient to be worth fixing. One of them is asking GIMP to do something that requires vast amounts of memory, such as creating an image one million pixels on a side.

You should also make sure that you are using an up-to-date version of GIMP: reporting bugs that have already been fixed is just a waste of everybody's time. (GIMP 1 is no longer maintained, so if you use it and find bugs, either upgrade to GIMP 2 or live with them.) Particularly if you are using the development version of GIMP, make sure that you can see the bug in the latest release before filing a report.

If after due consideration you still think you have a legitimate bug report or enhancement request, the next step is to go to GIMP's list of issues (<https://gitlab.gnome.org/GNOME/gimp/issues/>), and try to see whether somebody else has already reported the same thing.

.10.1 Find a Specific Bug

Enter some (space separated) search terms, e.g.

filter crash

in the "Search or filter results..." text box and press Enter. By default you only see open reports; you can change this by clicking "All" above the search field.

The result is either a list of bug reports – hopefully not too long – or a message saying "Sorry, your filter produced no results". If you don't find a related bug report by doing this, it may be worth trying

another search with different terms. If in spite of your best efforts, you file a bug report and it ends up being closed as a duplicate, don't be too upset: it has happened repeatedly to the author of this documentation.

.11 Reporting the Bug

Okay, so you have done everything you could to make sure, and you still think it's probably a bug. You should then go ahead and file a bug report on the GitLab page.

Note



The first time you file a bug report, you will be asked to create a GitLab account. The process is easy and painless, and you probably won't even get any spam as a result.

1. File a New Issue

Go to <https://gitlab.gnome.org/GNOME/gimp/issues>, and select New issue.

If you are not logged in, you are automatically redirected to the login page. After entering your user name (login) and password, you get back to the "New Issue" page.

2. Fill out the Template

Select Choose a template and choose whether you plan to report a bug or to request a feature. Note that most of the information you enter can be changed later by the developers if you get it wrong, so try to get it right but don't be obsessive about it.

Title Give a one-sentence summary that is descriptive enough so that somebody searching for similar bugs would find your bug report on the basis of the words this summary contains.

Description Describe the problem. Be as specific as you can, try to provide all the information requested from you, and include all information that you think might possibly be relevant. The classic totally useless bug report is, "GIMP crashes. This program sucks". There is no hope that the developers can solve a problem if they can't tell what it is.

Sometimes it is very helpful to augment a bug report with a screenshot or some other type of data. If you need to do this, click on the button Attach a file, and follow the directions. But please don't do this unless you think the attachment is really going to be useful—and if you need to attach a screenshot, don't make it any larger than necessary. Bug reports are likely to remain on the system for years, so there is no sense in wasting memory.

When you have filled out all of these things, press the Submit issue button and your bug report will be submitted. It will be assigned a number, which you may want to make note of; you will, however, be emailed any time somebody makes a comment on your bug report or otherwise alters it, so you will receive reminders in any case. You can see the current state of your bug report at any time by going to <https://gitlab.gnome.org/GNOME/gimp/issues/>.

Part IX

How to Contribute

Welcome to the GIMP-Help team!

This tutorial is intended for writing documentation. If you want to *translate* the documentation or the user interface, please go to “<https://l10n.gnome.org/teams/xx>” where “xx” is your language code: ISO 639-1 language codes can be found at http://www.loc.gov/standards/iso639-2/php/code_list.php.

.12 Prerequisites

.12.1 Join our mailing list

You can join our mailing list at <https://mail.gnome.org/mailman/listinfo/gimp-docs-list>. Please, feel free to ask questions.

.12.2 Create a Local Working Copy of Code

The GIMP help Manual is lodged in a central repository at <https://gitlab.gnome.org/GNOME/gimp-help>. Creating a local copy of this repository to work on makes sure that everyone can work on his own without fuzzing around into works of other contributors.

As a newbie, you will access the git repository anonymously (without an account). Open a terminal and type: `git clone https://gitlab.gnome.org/GNOME/gimp-help.git`.

If you have a GNOME account, the command is: `git clone git@gitlab.gnome.org:GNOME/gimp-help.git`

This will create a “gimp-help” folder in your current directory. Be patient! That’s a big download: about 700 MB.

.12.3 Installing your sandbox

After downloading your local copy, run: `cd gimp-help then ./autogen.sh --without-gimp ALL_LINGUAS="en xx"`.

When running `./autogen.sh`, you can notice some not found packages, for example “checking for dblatex... no”. Most of them are related to PDF files and you have to install them before running `./autogen.sh` again if you want to create PDF files.

.12.4 The gimp-help folder

The GIMP User Manual is maintained in the xml files of the “src” folder. You will use these xml files to work on.

.13 Workflow

.13.1 Writing

The language is English (USA).

To edit XML files, use your preferred text editor (this guide’s author prefers the free editor Kate). You must set the editor for:

- English-US language.
- Indent with 2 spaces (the **Tab** key must move pointer by two spaces).
- Replace tabs with spaces (for compatibility with all text editors and web browsers).
- 80 characters per line.
- Automatic spell checking with English (USA) for default language.

Source files are written in the XML language according to the DocBook DTD. DocBook specifications can be found at <http://tdg.docbook.org/tdg/4.5/docbook.html>.

Don’t be afraid. We don’t use all these items and you will learn XML progressively reading existing XML files. For new files, please use the templates you can find in the `gimp-help/docs/templates` folder.

Note



If you write a new file, you must add it in the `src/gimp.xml` file, or in the XML file that calls it (for example, the `src/menus/edit.xml` file calls `undo.xml`, `redo.xml`, `fade.xml`... and so on).

.13.2 Validating

When you have finished writing, you should validate your work:

- For a single file, you can use the following command line: **`xmllint --noout --nonet --valid your-file.xml`**. This command displays nothing if your file is OK. When an error is found it will show a message indicating the kind of error and where in your file it was encountered.

This command can be used for quickly checking an xml file. It can miss or may not find some errors. In case of external references to other files it also may show incorrect error messages, because this command only checks a single file.

(The Kate editor has an option (a plug-in) to validate the active xml file.)

- When you want to check multiple files or the whole gimp-help repository you should run **`make validate-en`**. You should get a “No error” message.

If not, a list of validity errors is displayed with line numbers referring to the `en.xml` log file that you can find in the `/log` folder.

Open this `en.xml` file in a text editor, use the “jump to line” command of your editor (the Kate editor command is `Ctrl-G`), and enter the line number to jump to the concerned line in the `en.xml` file. There, you will find the error.

If you have worked on several XML files, look above in the `en.xml` file to find (in the “`xml:base`” field of the “`id`” tag), in which xml file the error is.

Fix the error. Don’t forget to save the file and run **`make validate-en`** again.

Note



A common mistake is editing the `en.xml` log file instead of the XML file.

.13.3 Images

You also have to manage screenshots. Here are some hints for making good screenshots:

- reduce screenshot area as much as possible cropping the window manager borders and disabling the help button (you can do it in the preference dialog),
- set the image mode to indexed 255 colors `Image → Mode → Indexed`
This is not necessary for icons and if your image has only few colors. In these cases, indexed images are bigger than non-indexed.
- set print resolution to 144 ppi (not for small images like icons). You can do this easily with GIMP from `Image → Print Size...`
- Export images in the PNG format.

Don't include English text in images. Translators can't translate it and many users don't like that. Use XML captions instead, or provide a .xcf file in the Docs → xcf images folder, indicating it by a comment in the XML file:

```
<!--TO TRANSLATORS: a .xcf file is in
https://gitlab.gnome.org/GNOME/gimp-help/tree/master/docs/xcf-images
-->
```

Icons for GIMP are in `usr/share/gimp/2.0/icons`. GTK icons are in `usr/share/gtk-doc/html/gtk2`. To include an icon in the text:

```
<guiicon><inlinegraphic fileref="path-to-icon"/></guiicon>
```

Three commands to manage your images:

- **make check-image-resolutions-en**: gives the references of images whose resolution is not 144 ppi.
- **make check-images-en**: give references of missing or orphaned images.
- **mogrify units PixelsPerTrack -density 144x144 *.png** to set the print resolution of all PNG images.

.13.4 Create HTML Files

Once XML files have been validated, run **make html-en**. Creating HTML files is important to have an idea about what users will see. You will probably notice some improvements to be made on your XML file.

You can make an HTML draft (when the folder `xml/en` has been created during validation) for a single source xml file, by running, for instance, the command **make preview-xml/en/path-to-file.xml**. This creates `draft.html` file in the `html` folder.

You can also use `yelp` and run **yelp file:///your-file.xml**.

.13.5 Sending your files

When your files are ready:

You don't have a GNOME account if you don't have a GNOME account, you must find a correspondent who accepts to "push" files for you; that will not be difficult if you send a message to the list. Either you send your xml files and the attached images in a compressed file, (in a tree reproducing that of the `src` and `images` folders if you send several files to make your correspondent's task easier), or you send a "patch" that you have to create.

Before creating a patch, you have to get all your xml files and images in the index. Being in the `gimp-help` folder, do **git status**. If you have files in the Untracked files section, run **git add -A**.

Then run **diff --full-index --binary origine > name-of-the-patch** to create the patch.

You have a GNOME account All being well, you know how to manage Git. There are many tutorials for that on the Web.

A common workflow is:

- `make validate-en`
- `git status`
- `git stash`
- `git pull`
- `git status`
- `git stash apply`
- Eventually, fix conflicts
- `git add -A`
- `git status`
- `git commit -m "a message"`
- `git push`

.14 Annexes

XML notes ID's

ID's, which identify commands and are used when pressing the F1 key in the GIMP interface, are in <https://git.gnome.org/browse/gimp/tree/app/widgets/gimphelp-ids.h>

XML Tags Examples

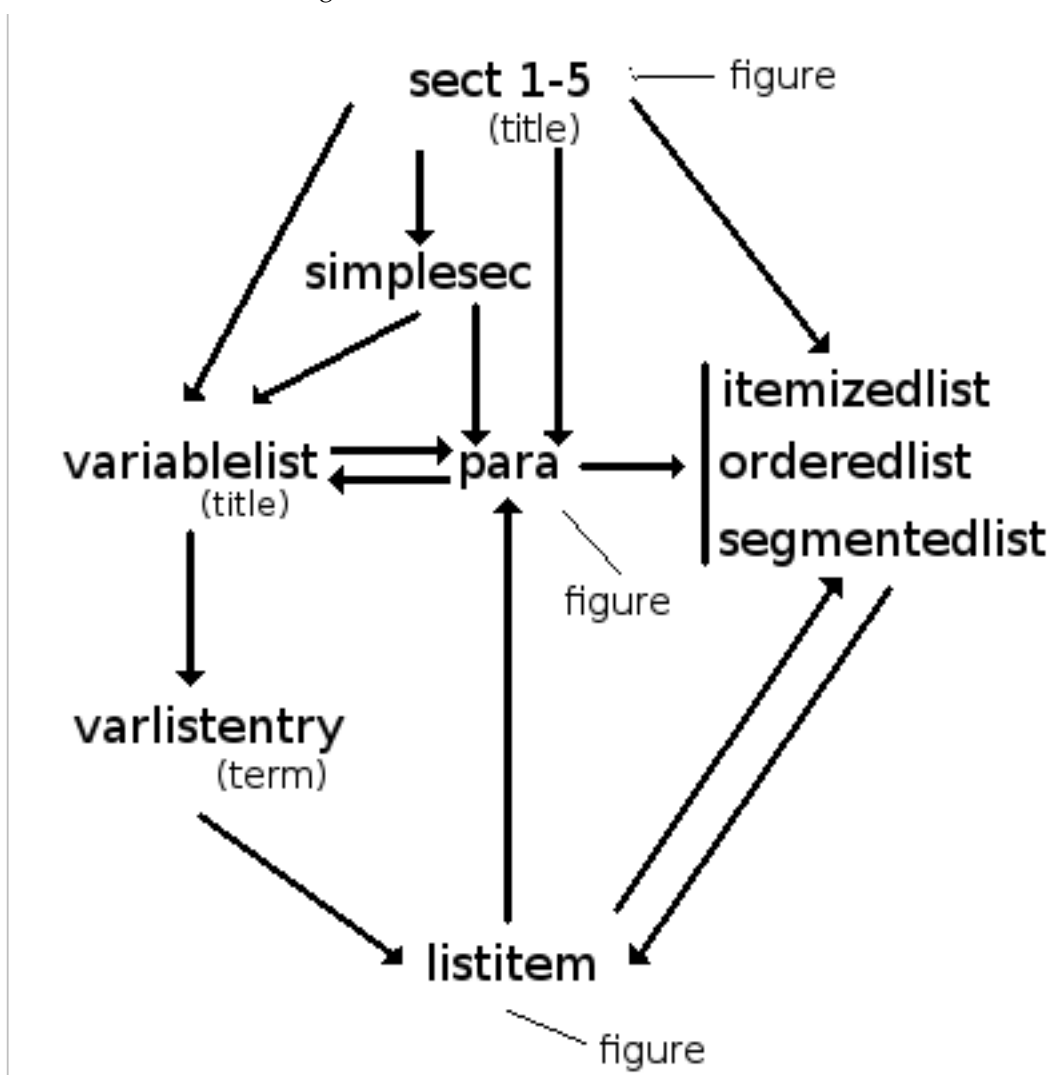
procedure: in using/web.xml.

table: in toolbox/tools-painting.xml.

programlisting: in filters/web/slice.xml.

segmentedlist: in dialogs/path-dialog.xml for a n columns list.

Parents and Children Here is a diagram I often use.



.15 Working under Windows

If you are using Windows you have to install Cygwin or a similar program to simulate Linux to be able to install the programs used in writing. This chapter will tell you how to install Cygwin on Windows and what packages needed to work on the GIMP manual.

The first thing to do is downloading the “setup.exe” from <http://www.cygwin.com/> and save it on your computer. You need this program every time you have to do changes in Cygwin, so save it on a place easily to find, e.g. “D:/cygwin/cygwin.exe”.

Open the program setup.exe by double-clicking on it. This will open the start window. Click on the “Next” button to open a window where you have to choose how to install Cygwin. The default setting

is “Install from Internet”. This means that the downloaded files will be saved on your computer before the files will be used to install Cygwin. This is the easiest way to do it.

In the next window you have to choose where to install Cygwin on your computer. The default is C:\cygwin which is a good choice. Normally you also choose the installation for all users.

If you marked the “Download without Installing” in the previous window you will instead get a window where you determines where to save the files. This window will be the next window if you install from internet.

The next window is how the computer is connected to internet. Normally you choose the default setting.

In the window “Choose A Download Site” you will find lots of sites to download from. You may choose any of those starting with “http://”, but it is a good rule to select one near you. The installation program makes a folder with the same name as the site you downloads from. If you change site, all the previous downloads will be downloaded again in the new folder. That is not a problem. Normally the program remember the last site used the next time you open it.

The next window lists all package categories available in Cygwin. A package contains programs or program parts to be used in Cygwin. You do not need all of them. As you see, every category is followed by a symbol and the word “Default”. This means that the installer will only load the packages necessary to run a minimum version of Cygwin. So go on and press the “Next” button and admire the progress of the downloading in the next window.

When downloading and installing is finished your copy of Cygwin is ready to be adapted to GIMP.

.15.1 Adapting Cygwin to use with GIMP documentation tools

I am not able to guarantee that the procedure described here will work for you. It is a resume of the way I did it. Tested on Windows XP and Windows 7.

To be sure that Cygwin will use your language and the char code used in GIMP documentation I changed the batch file used to open Cygwin. (After saving a copy of the original batch file.) If you used the default installation you will find the batch file in C:/cygwin/Cygwin.bat. Rewrite the batch file to

```
@echo off
C:
chdir C:\cygwin\bin
set LANG=[language-code].UTF-8
bash --login -i
```

If you have put Cygwin in another location than the default, you have to write the new path instead of “C:\cygwin\bin” above. You may find your language code in <http://gcc.gnu.org/onlinedocs/libstdc++/manual/localization.html>.

Then you are ready for the next step. Open “cygwin/startup.exe ” and click on “Next” until you reach the package window. You need the following packages:

```
Devel/automake 1.12
Devel/gettext-devel
Devel/gettext
Libs/libxml2
Libs/libxml2-devel
Interpreters/m4
Devel/make
Devel/pkg-config
Libs/libxslt
Libs/libxslt-devel
Python/python
Python/python-libxml2
Python/python-libxslt
Text/docbook-xml45
Graphics/ImageMagic
...../wget
...../dblatex
...../pngcrush
```

The first package to be installed is the “automake 1.12” in the “Devel” category. Click on the + mark in front of the category’s name (Devel) to open the package list. Search down the rightmost column to find the package name “automake 1.12”. Click once on the word “Skip”. The text will change to “1.12.3-1” which is the version number for the chosen package. Do the same with the other packages in the list above. Some packages will be marked “Keep” instead of “Skip”. This means that these packages already are installed. Do not alter these settings unless you know for certain that this package should be deleted, or reloaded, or something else.

When you have marked all packages to be added to Cygwin you press “Next”. You will then be told that the packages you selected needs some additional packages. Accept this. When you reaches the end of the updating, your Cygwin copy is ready for all that stuff mentioned in the start of this side.

Some packages, especially those needed for PDF, can’t be found with setup.exe. You can try installing them from sources. You can use “wget url-to-the-package” to download the wanted package, but, as you have to know the url, the best way is browsing the web under Windows; download the package (usually a .tar.gz file) and copy-paste into the Cygwin folder.

Then run **tar -xvzf your-package** to decompress the package.

Go into the new folder and read the INSTALL file for instructions about installation.

Note



pngnq cannot be installed from sources under Cygwin (dark problems with the libz library).

If you run into problems as mysterious error messages and so one, feel free to ask for help on the mailing list mentioned on the top of this page.

Part X

Tone Mapping and Shadow Recovery Using GIMP's 'Colors/Exposure'

This tutorial comes from www.gimp.org/tutorials and was created by Elle Stone. It is presented here for translations.

A very common editing problem is how to lighten the shadows and midtones of an image while retaining highlight details, a task sometimes referred to as “shadow recovery” and more generally speaking as “tone mapping”. This step-by-step tutorial shows you how to use high bit depth GIMP’s floating point “Colors/Exposure” operation to add one or more stops of positive exposure compensation to an image’s shadows and midtones while retaining highlight details.

.16 High bit depth GIMP’s floating point “Colors/Exposure”: much better than Curves for lightening the shadows and midtones of an image without blowing the highlights

A very common editing problem is how to lighten the shadows and midtones of an image without blowing out the highlights, which problem is very often encountered when dealing with photographs of scenes lit by direct sunlight. Precanned algorithms for accomplishing this task are often referred to as “shadow recovery” algorithms. But really these algorithms are special-purpose tone-mapping algorithms, which sometimes work pretty well, and sometimes not so well, depending on the algorithm, the image, and your artistic intentions for the image.

This step-by-step tutorial shows you how to use GIMP’s unbounded floating point “Colors/Exposure” operation to recover shadow information—that is, add one or more stops of positive exposure compensation to an image’s shadows and midtones—without blowing out or unduly compressing the image highlights. The procedure is completely “hand-tunable” using masks and layers, and is as close as you can get to non-destructive image editing using high bit depth GIMP 2.9/2.10.

Figure 1: power lines at noon

Before and after tone mapping (aka “shadow recovery”) using high bit depth GIMP’s floating point “Colors/Exposure”.



Scene-referred interpolated raw file.



After tone mapping/shadow recovery using GIMP unbounded Levels.

High bit depth GIMP is my primary image editor, and I've used the procedure described below for the last couple of years as my "go to" way to modify image tonality. The same general procedure can be used to darken as well as lighten portions of an image, again controlling the effect using a layer mask. This isn't exactly nondestructive editing because at some point you need to make a "New from Visible" layer. But unlike using Curves, using high bit depth GIMP's floating point "Colors/Exposure" doesn't clip RGB channel values and allows you to fine-tune the results by modifying and re-modifying the layer mask until you are completely happy with the resulting tonality.

.17 A step-by-step example showing how to recover shadow information using high bit depth GIMP's floating point "Colors/Exposure"

Figure 2



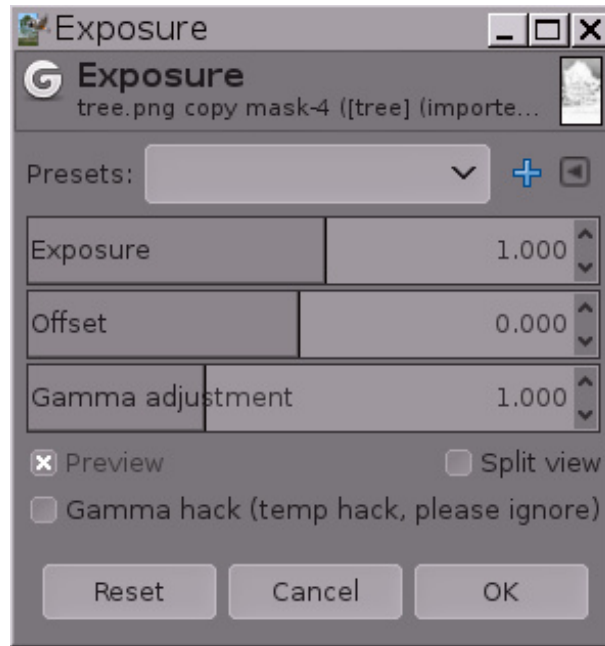
Using high bit depth GIMP's "Colors/Exposure" to lighten the ground by one stop without blowing out portions of the sky.

- *Left:* The original image, an interpolated camera raw file that was deliberately underexposed in camera to avoid blowing out the sky. It might not appear to be the case, but this image is already very close to having out of gamut RGB channel values in the sky, and a simple Auto Stretch Contrast won't lighten the image at all.
- *Right:* The same image after using high bit depth GIMP's "Colors/Exposure" at 32-bit floating point linear precision to add one stop of positive exposure compensation. An inverse grayscale mask was used to keep the highlights from blowing out.

This step-by-step example provides a sample image and is broken down into five steps, starting with downloading the image. Steps 3, 4, and 5 describe the actual procedure.

1. **Download [tree.png](#)**, which is a 16-bit integer sRGB image. High bit depth GIMP really is an "sRGB only" image editor, so it's best if you don't even try to edit in other RGB working spaces.
2. **Open [tree.png](#) with GIMP and assign the GIMP built-in sRGB profile (the image colors won't change a bit). Then convert the image to 32-bit floating point linear precision:** Go to "Image/Precision", select "32-bit floating point", and when the Dither dialog pops up, select "Linear light" (this ensures that the Normal blend mode produces radiometrically correct results).
3. Make a copy of the "tree.png" layer, and label it "+1 stop exposure comp". Then use "Colors/Exposure" to add one stop of positive exposure compensation—Figure 3 below shows the proper settings for the "Colors/Exposure" dialog, and Figure 4 shows the result:

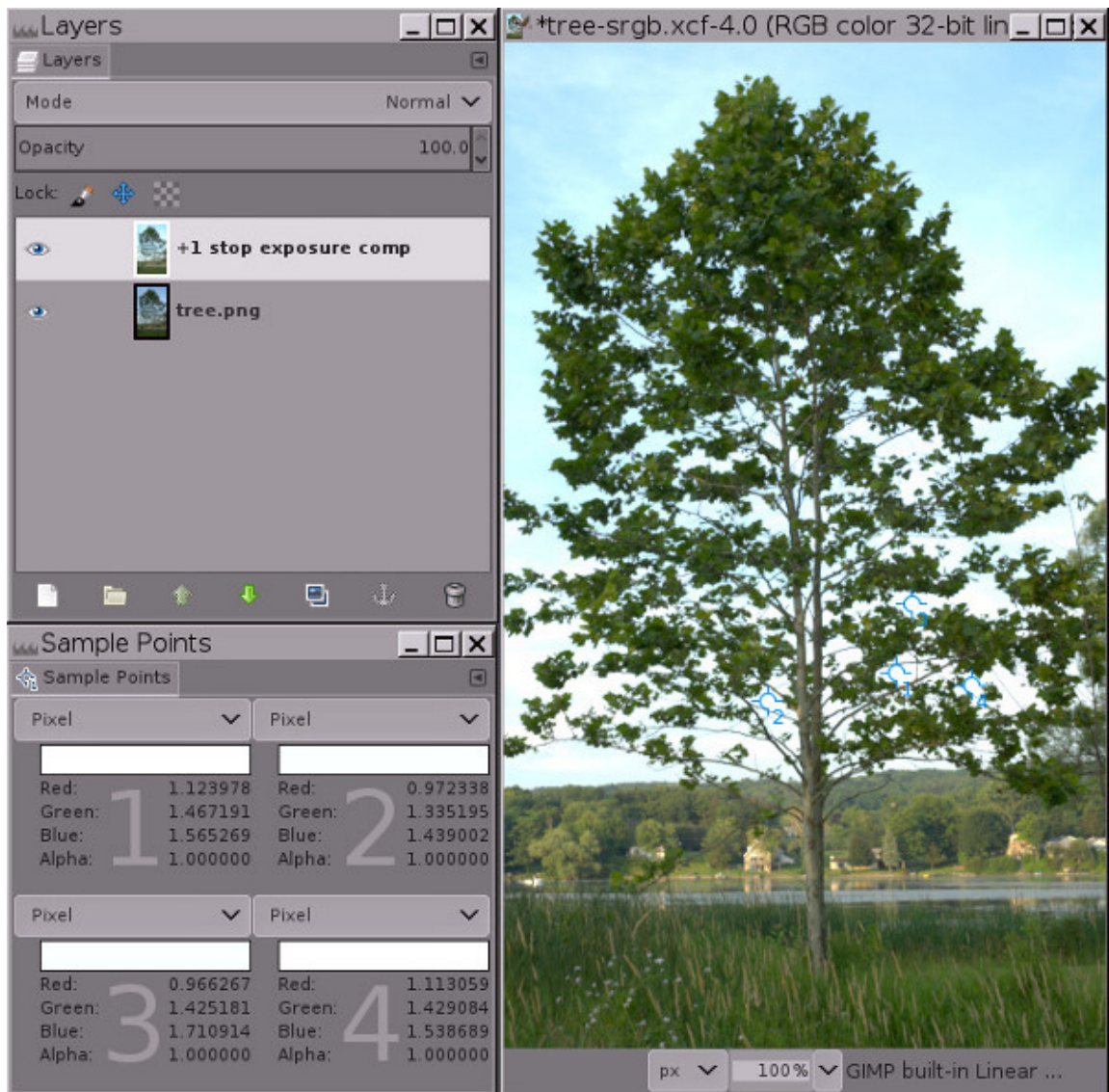
Figure 3



Using "Colors/Exposure" to add one stop of positive exposure compensation.

When using "Colors/Exposure" to add one stop of positive exposure compensation, make sure the image really is at floating point precision, because integer precision will clip the highlights.

Figure 4



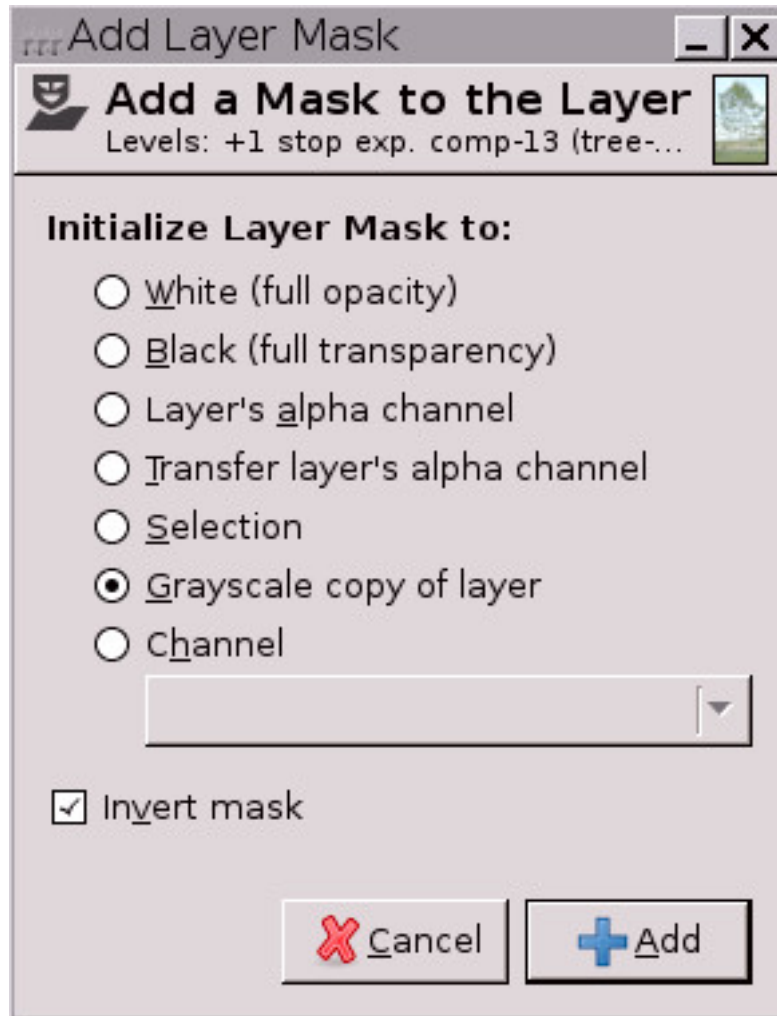
At floating point precision, GIMP’s “Colors/Exposure” operation is unbounded. This means you can use “Colors/Exposure” to add positive exposure compensation without blowing out the highlights.

Notice the RGB channel values for the four sample points: the channel information that would have been clipped using integer precision is encoded using channel values that are greater than 1.0 floating point.

The image in Figure 4 clearly has “blown” highlights in the sky. But the highlights aren’t really blown (that is, clipped to 1.0 in one or more channels). Instead the highlight information is still there, but the RGB channel values fall outside the RGB **display channel value** range of 0.0f to 1.0f. The sample points dialog in Figure 4 above shows four sample points that have RGB channel values that are greater than 1.0. As shown in Figure 5 below, adding a mask allows you to recover these highlights by bringing them back down into the display range.

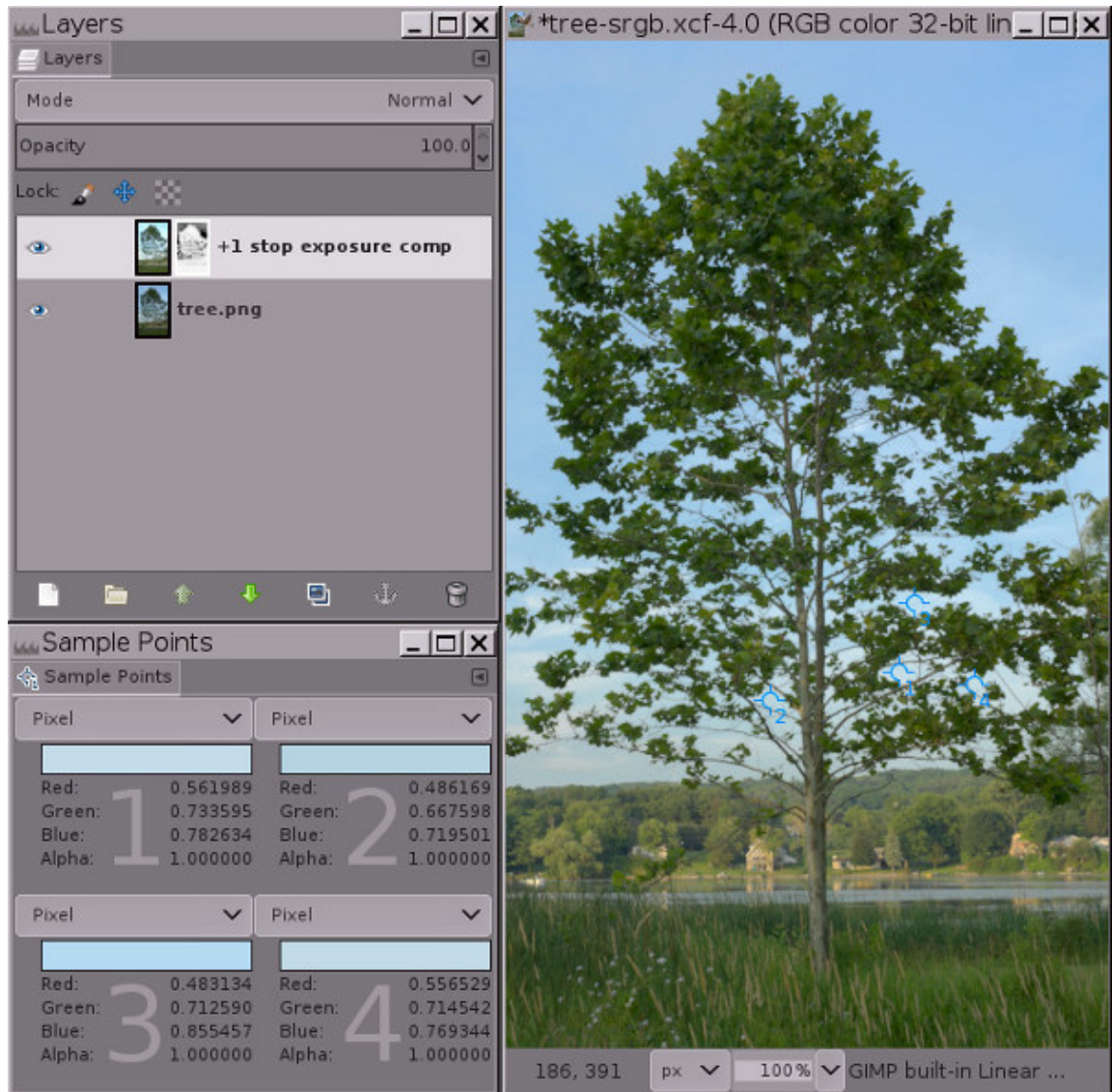
If you had used integer precision instead of floating point, the highlights really would be blown: The sample points would have a maximum channel values of 255, 65535 or 4294967295, depending on the bit depth. And masking would only “recover” a solid expanse of gray, completely lacking any details (try for yourself and see what happens).

4. **Add an inverse grayscale layer mask:** Right-click on the layer and select “Layer/Mask/Add Layer Mask”, and when the “Add a mask to the Layer” dialog pops up, choose “Grayscale copy of layer” and check the “Invert mask” box.



As shown in Figure 5 below, at this point the highlights will be brought back into the display range, meaning all RGB channel values are between 0.0f and 1.0f. But the image will probably look a little odd (sort of cloudy and flat), and depending on the image, the brightest highlights might actually have dark splotches—don't worry! this is temporary.

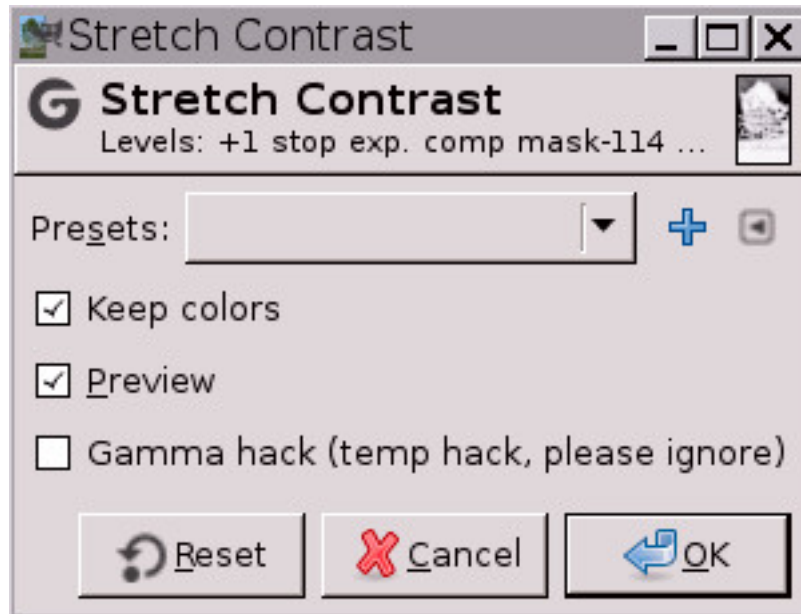
Figure 5



Result of adding an inverse grayscale layer mask to bring the highlights back into the display range.

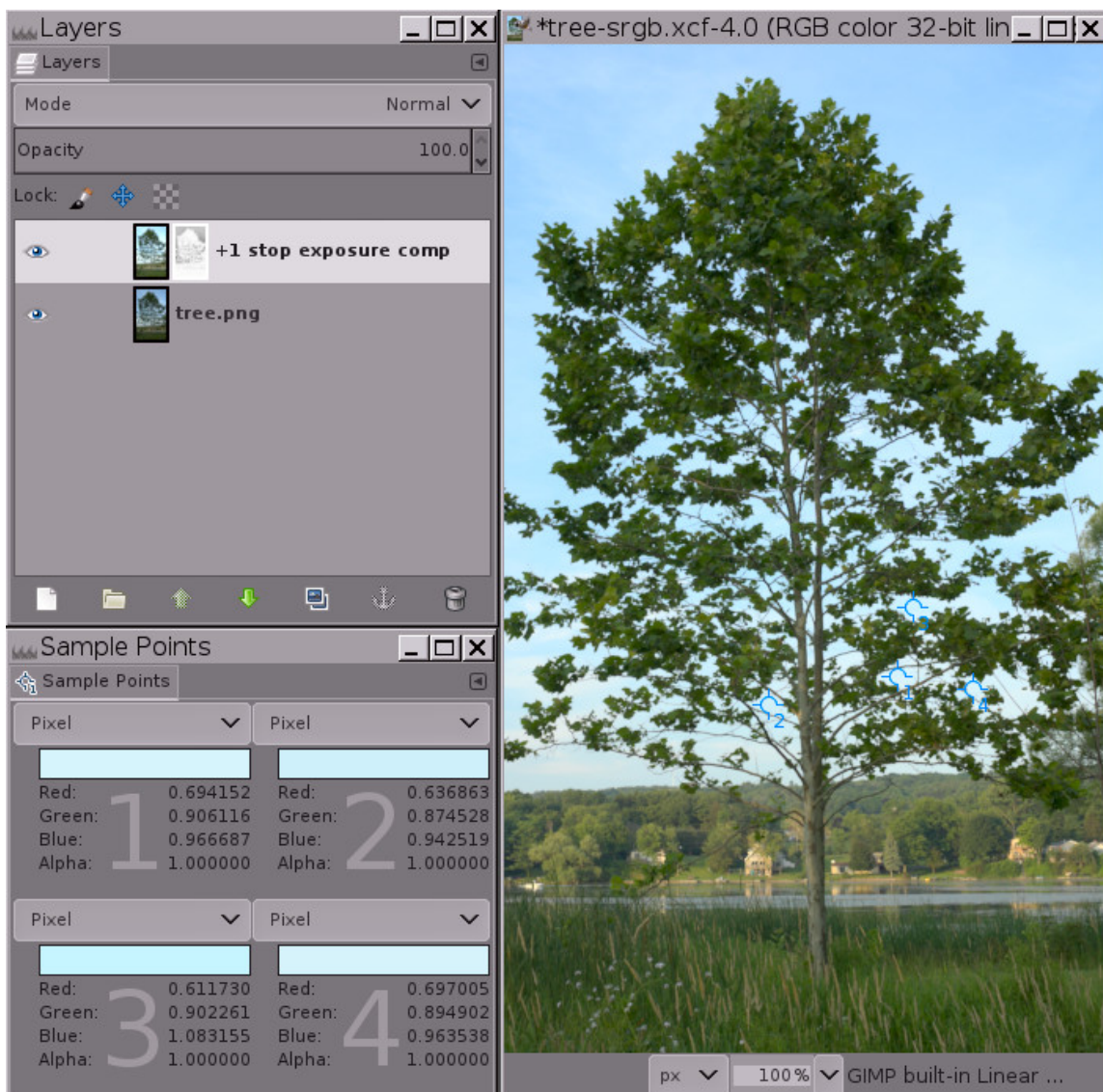
Adding an inverse grayscale layer mask brings the highlights back into the display range, but at this point most images will look flat and cloudy, and some images will have dark splotches in the highlights. The next step—“Auto Stretch Contrast” performed on the mask—will take care of this problem.

5. Click on the layer mask to select it for editing, and then select “Colors/Auto/Stretch Contrast”:



“Keep Colors” should be checked (though it doesn’t really matter on grayscale images such as layer masks).

Figure 6 below shows the final result:



Doing “Auto/Stretch Contrast” on the layer mask removes the “cloudy” appearance, leaving a nicely bright-

ened image with intact highlights.

“Auto/Stretch Contrast” on the mask is necessary because just like the image layer has out of gamut RGB channel values, the inverted grayscale mask contains out of gamut grayscale values. “Auto/Stretch Contrast” brings all the mask grayscale values back into the display range, allowing the mask to proportionately compensate for the layer’s otherwise out-of-gamut RGB channel values, masking more in the layer highlights and less/not at all in the image’s shadows and midtones.

Notice that one of the sample points still has a blue RGB channel value that is slightly out of gamut. The easiest way to deal with this is to “Colors/Exposure” to make a Gamma adjustment of 0.45 on the mask, not on the actual image layer. You can make this Gamma adjustment either on the entire mask (works well, less effort). Or else you can make the adjustment just on the mask shadows (which correspond to the layer highlights), in which case you’d load the mask as a selection, invert the selection, and make the Gamma adjustment. Or if the remaining out of gamut channel values are only very slightly out of gamut, make a “New from Visible” layer and then “Auto/Stretch Contrast” the result to bring the remaining channel values back into gamut.

That’s the whole procedure for using “Colors/Exposure” to add a stop of positive exposure compensation to the shadows without blowing out the highlights. Now you can either fine-tune the mask, or else just make a “New from Visible” layer and continue editing your nicely brightened image. Depending on the image and also on your artistic intentions for the image, the mask might not need fine-tuning. But very often you’ll want to modify the resulting tonal distribution by doing a “Colors/Exposure” gamma correction, or perhaps a Curves operation on the mask, or else by painting directly on the mask. And sometimes you’ll want to blur the mask to restore micro contrast[?listitem].

.18 Use Notes

1. Depending on your particular artistic intentions for an image, some images are more likely than others to benefit from being tone mapped using floating point “Colors/Exposure”. Your mileage may vary, but typically the procedure described on this page works best for photographs of scenes with a pronounced tonal difference between the highlights and shadows, as per typical sunny day “sky-ground” photographs.
2. **For adding just one stop of positive exposure compensation, the procedure described on this page works really well.** Depending on the image you might want to blur the mask using an edge-respecting blur algorithm, and/or tweak the mask using “Colors/Exposure”, Curves, etc. But only modify the mask after using Auto Stretch Contrast on the mask. Otherwise results will be unpredictable: **Gamma adjustments produce odd results when operating on out of gamut values**, and Curves will summarily clip out of gamut values.
3. **For adding more than one stop of exposure compensation, you can use one or more than one positive-exposure-compensation layers.** Either way the layer mask(s) will need careful tweaking that’s very image-specific and also specific to your intended result. Figure 7 shows an example of using two exposure compensation layers to add two and a half stops of exposure compensation to the shadows and midtones of an image:

Using GIMP’s floating point unbounded Levels plus layer masks to add two stops of positive exposure compensation to the shadows and midtones of a photograph of an apple orchard truck that was taken in bright sunshine.

Figure 7



Image from the camera, underexposed to avoid blowing out highlights.

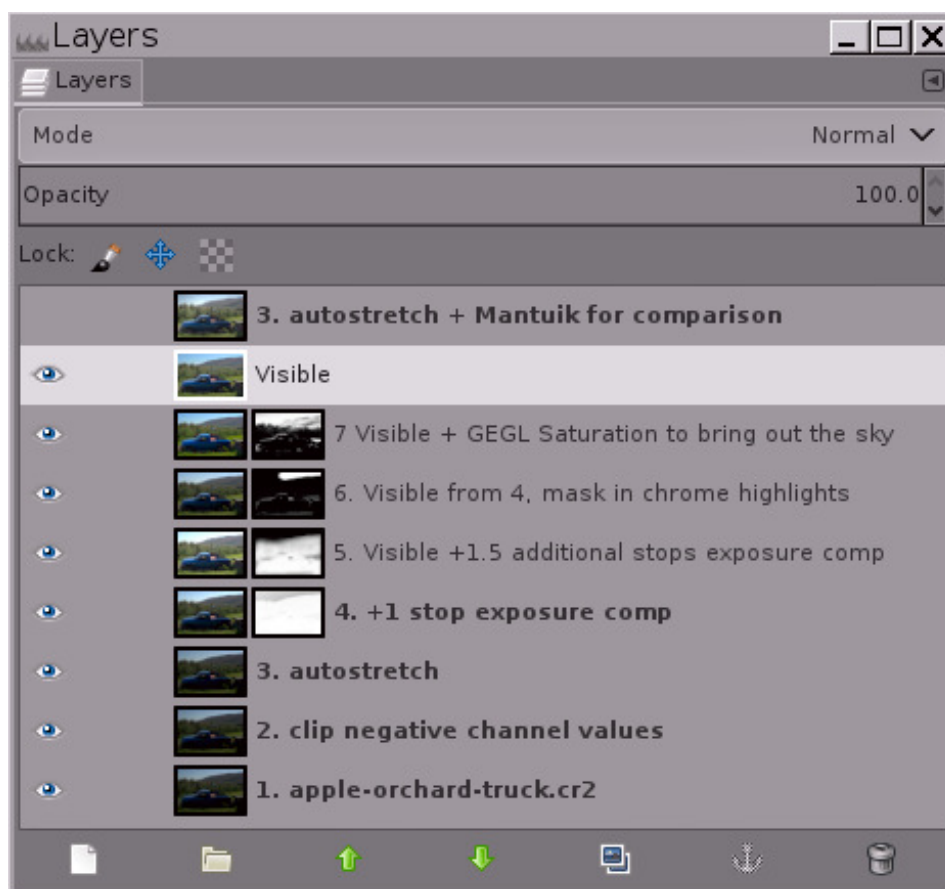


After tone mapping/shadow recovery using high bit depth GIMP's floating point "Color/Exposure".



For comparison, Mantuik tone mapping using the GEGL default settings.

Using GIMP's floating point "Colors/Exposure" plus layer masks to add two and a half stops of positive exposure compensation to the shadows and midtones of a "bright sun" photograph of an apple orchard truck.



A screenshot of the layer stack that I used to tone-map the photograph of the apple orchard truck. Tone-mapping by hand gives you complete control over the resulting image. Mantuik and other "automagic"

tone-mapping algorithms are CPU-intensive, unpredictable, and often produce unnatural-looking results.

4. Before using “Colors/Exposure” to add positive exposure compensation, *the base layer should already be stretched to its maximum dynamic range.* The easiest way to stretch the base layer to its maximum dynamic range is to do “Colors/Auto/Stretch Contrast” and make sure that “Keep colors” is checked.

If you’ve never used an unbounded floating point image editor before, “Colors/Auto/Stretch Contrast” can produce an unexpected result: The image might actually end up with a severely reduced dynamic range, having either lighter shadows or darker highlights or both:

Before and after doing “Colors/Auto/Stretch Contrast” on the base layer, plus the final image after tone mapping using “Colors/Exposure”:

Figure 8

1. Image from the camera



2. After doing “Colors/Auto/Stretch Contrast”.



3. Final "Power lines" image.



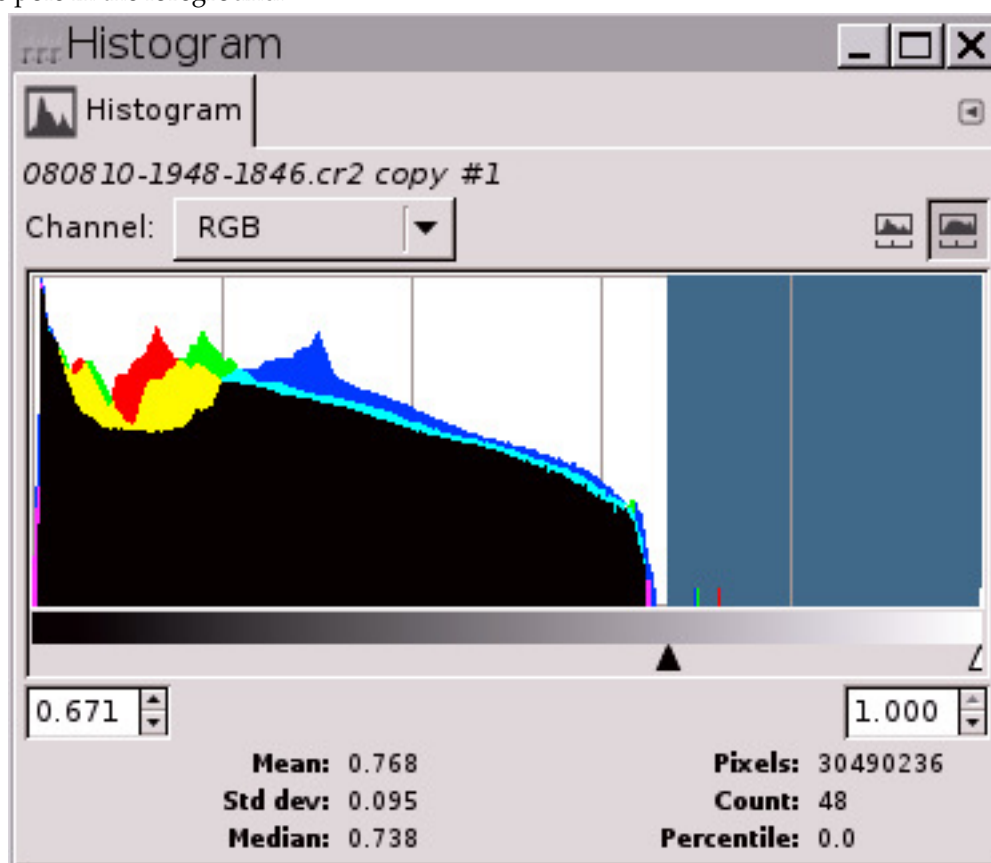
- (a) This scene-referred interpolated raw file from the PhotoFlow raw processor (which provides a GIMP plug-in for easy opening of raw files) has out-of-display-range RGB channel values that will be brought back into the display range by doing “Colors/Auto/Stretch Contrast”.
- (b) After doing “Colors/Auto/Stretch Contrast”, shadows are lighter and highlights are darker because the dynamic range has been compressed to fit within the display range. This looks like an editing step in the wrong direction! but actually it’s necessary.
- (c) Here’s the final “Power lines” image after tone mapping the scene-referred interpolated raw file using the procedure described in this tutorial.

As captured by the raw file, this picture of power lines marching into the distance is a typical result of taking a photograph at noon on a bright sunny day: The sky and clouds looked pretty good right out of the camera, but the ground was far too dark. So the image could benefit from some tone mapping to raise the shadows and midtones. The first step is to do “Colors/Auto/Stretch Contrast” to bring any channel values that are less than 0.0f or greater than 1.0f back within the display range of 0.0 to 1.0 floating point.

Performing “Auto/Stretch Contrast” to bring the channel values back inside the display range doesn’t exactly look like an editing step in the right direction for tone-mapping this particular image! but really it is. Using “Colors/Exposure” to add positive exposure compensation to the shadows and midtones won’t work if the image has channel values that fall outside the display range.

5. **Dispensing with “useless” shadow and highlight information:** Sometimes interpolated raw files of photographs of high dynamic range scenes end up with a sprinkling of highlight and shadow pixels that contains essentially no useful information. The easiest thing to do with such pixels is to use “Colors/Exposure” to set the desired black and white points, and then clip the resulting out of gamut channel information.

- **Useless highlight information:** For the “Power lines” picture shown in Figure 8 above, after doing “Color/Auto/Stretch Contrast”, a measly 48 pixels occupied nearly half the tonal range (see the histogram to the right). A little investigation with GIMP’s Threshold tool revealed that all 48 pixels are the peak values of specular highlights on the ceramic insulators on the power line pole in the foreground.



In cases where nearly half the histogram is occupied by a sprinkling of specular highlights, clipping the pixels is often the best and easiest solution. For the “Power lines” image, the 48 pixels in question carried essentially zero information. So I used “Colors/Exposure” to raise the white point, and then used “Colors/Clip RGB” to actually clip the channel information in the highlights (this time making sure the “Clip high pixel values” box was checked).

- **Useless shadow information:** Some raw processors can output images with negative channel values. And previous edits using high bit depth GIMP might have produced negative channel values. If doing an “Auto/Stretch Contrast” on your base image layer makes the image a whole lot lighter in the shadows, the problem is negative RGB channel values. One solution is to use “Colors/Exposure” to move the black point to where you want it to be, and then clip the negative channel values. Here are two ways to clip negative channel values:
 - Use “Colors/Clip RGB...”, making sure to uncheck the “Clip high pixel values” box.
 - Or else create a solid black layer above your base image layer, set the blend mode to “Lighten only”, and make a “New from Visible” layer.
6. **Blurring the mask to restore micro contrast:** Putting an inverse mask on a layer that’s used to add positive exposure compensation necessarily slightly flattens micro contrast. Depending on your artistic intentions for the image, you might want to blur the mask to restore micro contrast. The trick is how to blur the mask without introducing “halos” around the edges of objects in the image. Small radius Gaussian blurs produce small but distressingly obvious halos around dark edges. A large radius gaussian blur sometimes works but just as often produces a large obvious halo separating the brighter and darker portions of the image. For many images a better solution is to blur the mask use an edge-respecting filter such as the GIMP G’MIC bilateral smooth filter:

Adding exposure compensation with and without bilateral smoothing of the mask.

Figure 9



Without applying bilateral smoothing to the mask, micro contrast is flattened.



After applying bilateral smoothing to the mask, micro contrast is restored.

Adding exposure compensation combined with an inverse grayscale mask does flatten micro contrast, which might or might not be desirable depending on your artistic intentions for the image. To restore micro contrast, try using an edge-respecting blur such as G'MIC's bilateral smoothing filter. GIMP G'MIC doesn't work on layer masks. A workaround is to turn the unblurred mask into a selection, save the selection as a channel, and then drag the channel to the layer stack for blurring.

7. An essential component of the procedure for using "Colors/Exposure" to add positive exposure compensation to images with dark shadows and midtones needs to be explicitly mentioned: Not only is the high bit depth GIMP's "Colors/Exposure" operation unbounded at floating point precision — **layer masks are also unbounded**.

If the inverted grayscale masks were summarily clipped (as is the case when editing at integer precision), then the procedure described in this tutorial wouldn't work.

.19 Conclusion

Photographs taken in bright direct sunlight typically are of high dynamic range scenes, and the resulting camera file usually requires careful tone mapping to produce a satisfactory final image. High bit depth GIMP's floating point "Colors/Exposure" provides a very useful tool for dealing with this type of image, and of course is equally useful for any image where the goal is to raise the shadows and midtones without blowing out the highlights.

High bit depth GIMP's floating point "Colors/Exposure" combined with a suitable layer mask can also be used to darken portions of the image, either by moving the upper left Value slider to the right (darkens the image by increasing contrast and also increases saturation; requires careful masking to avoid producing regions of solid black), or moving the lower right Value slider to the left (darkens the image by decreasing contrast, useful for de-emphasizing portions of the image).

This is a GIMP-specific tutorial. However, the same technique can be employed using the PhotoFlow raw processor and possibly other image editors that allow for 32-bit floating point processing using un-

bounded RGB channel values. The neat thing about using this technique in PhotoFlow is that PhotoFlow uses nodes, which allows for completely non-destructive editing of the inverted grayscale mask that's used to recover the highlight detail after applying positive exposure compensation to raise the tonality of the shadows and midtones (even if you close and reopen the image, if you save the image's PFI file).

The original tutorial this was adapted from can be and is reproduced courtesy of Elle Stone

GIMP Tutorial - Tone Mapping Using GIMP Levels (text and images) by Elle Stone is licensed under a Creative Commons Attribution-ShareAlike 3.0 Unported License

Part XI

GNU Free Documentation License

Note that any translations of the GNU Free Documentation License are not published by the Free Software Foundation, and do not legally state the distribution terms for software that uses the GNU FDL-only the original English text of the GNU FDL does that.

The GIMP Documentation Team

Copyright (C) 2000,2001,2002 Free Software Foundation, Inc. 59 Temple Place, Suite 330, Boston, MA 02111-1307 USA. Everyone is permitted to copy and distribute verbatim copies of this license document, but changing it is not allowed.

.20 PREAMBLE

The purpose of this License is to make a manual, textbook, or other functional and useful document “free” in the sense of freedom: to assure everyone the effective freedom to copy and redistribute it, with or without modifying it, either commercially or noncommercially. Secondly, this License preserves for the author and publisher a way to get credit for their work, while not being considered responsible for modifications made by others.

This License is a kind of “copyleft”, which means that derivative works of the document must themselves be free in the same sense. It complements the GNU General Public License, which is a copyleft license designed for free software.

We have designed this License in order to use it for manuals for free software, because free software needs free documentation: a free program should come with manuals providing the same freedoms that the software does. But this License is not limited to software manuals; it can be used for any textual work, regardless of subject matter or whether it is published as a printed book. We recommend this License principally for works whose purpose is instruction or reference.

.21 APPLICABILITY AND DEFINITIONS

This License applies to any manual or other work, in any medium, that contains a notice placed by the copyright holder saying it can be distributed under the terms of this License. Such a notice grants a world-wide, royalty-free license, unlimited in duration, to use that work under the conditions stated herein. The “Document”, below, refers to any such manual or work. Any member of the public is a licensee, and is addressed as “you”. You accept the license if you copy, modify or distribute the work in a way requiring permission under copyright law.

A “Modified Version” of the Document means any work containing the Document or a portion of it, either copied verbatim, or with modifications and/or translated into another language.

A “Secondary Section” is a named appendix or a front-matter section of the Document that deals exclusively with the relationship of the publishers or authors of the Document to the Document’s overall subject (or to related matters) and contains nothing that could fall directly within that overall subject. (Thus, if the Document is in part a textbook of mathematics, a Secondary Section may not explain any mathematics.) The relationship could be a matter of historical connection with the subject or with related matters, or of legal, commercial, philosophical, ethical or political position regarding them.

The “Invariant Sections” are certain Secondary Sections whose titles are designated, as being those of Invariant Sections, in the notice that says that the Document is released under this License. If a section does not fit the above definition of Secondary then it is not allowed to be designated as Invariant. The Document may contain zero Invariant Sections. If the Document does not identify any Invariant Sections then there are none.

The “Cover Texts” are certain short passages of text that are listed, as Front-Cover Texts or Back-Cover Texts, in the notice that says that the Document is released under this License. A Front-Cover Text may be at most 5 words, and a Back-Cover Text may be at most 25 words.

A “Transparent” copy of the Document means a machine-readable copy, represented in a format whose specification is available to the general public, that is suitable for revising the document straightforwardly with generic text editors or (for images composed of pixels) generic paint programs or (for drawings) some widely available drawing editor, and that is suitable for input to text formatters or for automatic translation to a variety of formats suitable for input to text formatters. A copy made in an otherwise Transparent file format whose markup, or absence of markup, has been arranged to thwart or discourage subsequent modification by readers is not Transparent. An image format is not Transparent if used for any substantial amount of text. A copy that is not “Transparent” is called “Opaque”.

Examples of suitable formats for Transparent copies include plain ASCII without markup, Texinfo input format, LaTeX input format, SGML or XML using a publicly available DTD, and standard-conforming simple HTML, PostScript or PDF designed for human modification. Examples of transparent image formats include PNG, XCF and JPG. Opaque formats include proprietary formats that can be read and edited only by proprietary word processors, SGML or XML for which the DTD and/or processing tools are not generally available, and the machine-generated HTML, PostScript or PDF produced by some word processors for output purposes only.

The “Title Page” means, for a printed book, the title page itself, plus such following pages as are needed to hold, legibly, the material this License requires to appear in the title page. For works in formats which do not have any title page as such, “Title Page” means the text near the most prominent appearance of the work’s title, preceding the beginning of the body of the text.

A section “Entitled XYZ” means a named subunit of the Document whose title either is precisely XYZ or contains XYZ in parentheses following text that translates XYZ in another language. (Here XYZ stands for a specific section name mentioned below, such as “Acknowledgements”, “Dedications”, “Endorsements”, or “History”.) To “Preserve the Title” of such a section when you modify the Document means that it remains a section “Entitled XYZ” according to this definition.

The Document may include Warranty Disclaimers next to the notice which states that this License applies to the Document. These Warranty Disclaimers are considered to be included by reference in this License, but only as regards disclaiming warranties: any other implication that these Warranty Disclaimers may have is void and has no effect on the meaning of this License.

.22 VERBATIM COPYING

You may copy and distribute the Document in any medium, either commercially or noncommercially, provided that this License, the copyright notices, and the license notice saying this License applies to the Document are reproduced in all copies, and that you add no other conditions whatsoever to those of this License. You may not use technical measures to obstruct or control the reading or further copying of the copies you make or distribute. However, you may accept compensation in exchange for copies. If you distribute a large enough number of copies you must also follow the conditions in [section 4](#).

You may also lend copies, under the same conditions stated above, and you may publicly display copies.

.23 COPYING IN QUANTITY

If you publish printed copies (or copies in media that commonly have printed covers) of the Document, numbering more than 100, and the Document’s license notice requires Cover Texts, you must enclose the copies in covers that carry, clearly and legibly, all these Cover Texts: Front-Cover Texts on the front cover, and Back-Cover Texts on the back cover. Both covers must also clearly and legibly identify you as the publisher of these copies. The front cover must present the full title with all words of the title equally prominent and visible. You may add other material on the covers in addition. Copying with changes limited to the covers, as long as they preserve the title of the Document and satisfy these conditions, can be treated as verbatim copying in other respects.

If the required texts for either cover are too voluminous to fit legibly, you should put the first ones listed (as many as fit reasonably) on the actual cover, and continue the rest onto adjacent pages.

If you publish or distribute Opaque copies of the Document numbering more than 100, you must either include a machine-readable Transparent copy along with each Opaque copy, or state in or with each Opaque copy a computer-network location from which the general network-using public has access to download using public-standard network protocols a complete Transparent copy of the Document, free of added material. If you use the latter option, you must take reasonably prudent steps, when you begin distribution of Opaque copies in quantity, to ensure that this Transparent copy will remain thus accessible at the stated location until at least one year after the last time you distribute an Opaque copy (directly or through your agents or retailers) of that edition to the public.

It is requested, but not required, that you contact the authors of the Document well before redistributing any large number of copies, to give them a chance to provide you with an updated version of the Document.

.24 MODIFICATIONS

You may copy and distribute a Modified Version of the Document under the conditions of sections 3 and 4 above, provided that you release the Modified Version under precisely this License, with the Modified Version filling the role of the Document, thus licensing distribution and modification of the Modified Version to whoever possesses a copy of it. In addition, you must do these things in the Modified Version:

- A. Use in the Title Page (and on the covers, if any) a title distinct from that of the Document, and from those of previous versions (which should, if there were any, be listed in the History section of the Document). You may use the same title as a previous version if the original publisher of that version gives permission.
- B. List on the Title Page, as authors, one or more persons or entities responsible for authorship of the modifications in the Modified Version, together with at least five of the principal authors of the Document (all of its principal authors, if it has fewer than five), unless they release you from this requirement.
- C. State on the Title page the name of the publisher of the Modified Version, as the publisher.
- D. Preserve all the copyright notices of the Document.
- E. Add an appropriate copyright notice for your modifications adjacent to the other copyright notices.
- F. Include, immediately after the copyright notices, a license notice giving the public permission to use the Modified Version under the terms of this License, in the form shown in the [Addendum](#) below.
- G. Preserve in that license notice the full lists of Invariant Sections and required Cover Texts given in the Document's license notice.
- H. Include an unaltered copy of this License.
 - I. Preserve the section Entitled "History", Preserve its Title, and add to it an item stating at least the title, year, new authors, and publisher of the Modified Version as given on the Title Page. If there is no section Entitled "History" in the Document, create one stating the title, year, authors, and publisher of the Document as given on its Title Page, then add an item describing the Modified Version as stated in the previous sentence.
 - J. Preserve the network location, if any, given in the Document for public access to a Transparent copy of the Document, and likewise the network locations given in the Document for previous versions it was based on. These may be placed in the "History" section. You may omit a network location for a work that was published at least four years before the Document itself, or if the original publisher of the version it refers to gives permission.
- K. For any section Entitled "Acknowledgements" or "Dedications", Preserve the Title of the section, and preserve in the section all the substance and tone of each of the contributor acknowledgements and/or dedications given therein.
- L. Preserve all the Invariant Sections of the Document, unaltered in their text and in their titles. Section numbers or the equivalent are not considered part of the section titles.
- M. Delete any section Entitled "Endorsements". Such a section may not be included in the Modified Version.
- N. Do not retitle any existing section to be Entitled "Endorsements" or to conflict in title with any Invariant Section.
- O. Preserve any Warranty Disclaimers.

If the Modified Version includes new front-matter sections or appendices that qualify as Secondary Sections and contain no material copied from the Document, you may at your option designate some or all of these sections as invariant. To do this, add their titles to the list of Invariant Sections in the Modified Version's license notice. These titles must be distinct from any other section titles.

You may add a section Entitled “Endorsements”, provided it contains nothing but endorsements of your Modified Version by various parties—for example, statements of peer review or that the text has been approved by an organization as the authoritative definition of a standard.

You may add a passage of up to five words as a Front-Cover Text, and a passage of up to 25 words as a Back-Cover Text, to the end of the list of Cover Texts in the Modified Version. Only one passage of Front-Cover Text and one of Back-Cover Text may be added by (or through arrangements made by) any one entity. If the Document already includes a cover text for the same cover, previously added by you or by arrangement made by the same entity you are acting on behalf of, you may not add another; but you may replace the old one, on explicit permission from the previous publisher that added the old one.

The author(s) and publisher(s) of the Document do not by this License give permission to use their names for publicity for or to assert or imply endorsement of any Modified Version.

.25 COMBINING DOCUMENTS

You may combine the Document with other documents released under this License, under the terms defined in [section 5](#) above for modified versions, provided that you include in the combination all of the Invariant Sections of all of the original documents, unmodified, and list them all as Invariant Sections of your combined work in its license notice, and that you preserve all their Warranty Disclaimers.

The combined work need only contain one copy of this License, and multiple identical Invariant Sections may be replaced with a single copy. If there are multiple Invariant Sections with the same name but different contents, make the title of each such section unique by adding at the end of it, in parentheses, the name of the original author or publisher of that section if known, or else a unique number. Make the same adjustment to the section titles in the list of Invariant Sections in the license notice of the combined work.

In the combination, you must combine any sections Entitled “History” in the various original documents, forming one section Entitled “History”; likewise combine any sections Entitled “Acknowledgements”, and any sections Entitled “Dedications”. You must delete all sections Entitled “Endorsements”.

.26 COLLECTIONS OF DOCUMENTS

You may make a collection consisting of the Document and other documents released under this License, and replace the individual copies of this License in the various documents with a single copy that is included in the collection, provided that you follow the rules of this License for verbatim copying of each of the documents in all other respects.

You may extract a single document from such a collection, and distribute it individually under this License, provided you insert a copy of this License into the extracted document, and follow this License in all other respects regarding verbatim copying of that document.

.27 AGGREGATION WITH INDEPENDENT WORKS

A compilation of the Document or its derivatives with other separate and independent documents or works, in or on a volume of a storage or distribution medium, is called an “aggregate” if the copyright resulting from the compilation is not used to limit the legal rights of the compilation’s users beyond what the individual works permit. When the Document is included in an aggregate, this License does not apply to the other works in the aggregate which are not themselves derivative works of the Document.

If the Cover Text requirement of [section 4](#) is applicable to these copies of the Document, then if the Document is less than one half of the entire aggregate, the Document’s Cover Texts may be placed on covers that bracket the Document within the aggregate, or the electronic equivalent of covers if the Document is in electronic form. Otherwise they must appear on printed covers that bracket the whole aggregate.

.28 TRANSLATION

Translation is considered a kind of modification, so you may distribute translations of the Document under the terms of [section 5](#). Replacing Invariant Sections with translations requires special permission

from their copyright holders, but you may include translations of some or all Invariant Sections in addition to the original versions of these Invariant Sections. You may include a translation of this License, and all the license notices in the Document, and any Warranty Disclaimers, provided that you also include the original English version of this License and the original versions of those notices and disclaimers. In case of a disagreement between the translation and the original version of this License or a notice or disclaimer, the original version will prevail.

If a section in the Document is Entitled “Acknowledgements”, “Dedications”, or “History”, the requirement (section 5) to Preserve its Title (section 2) will typically require changing the actual title.

.29 TERMINATION

You may not copy, modify, sublicense, or distribute the Document except as expressly provided for under this License. Any other attempt to copy, modify, sublicense or distribute the Document is void, and will automatically terminate your rights under this License. However, parties who have received copies, or rights, from you under this License will not have their licenses terminated so long as such parties remain in full compliance.

.30 FUTURE REVISIONS OF THIS LICENSE

The Free Software Foundation may publish new, revised versions of the GNU Free Documentation License from time to time. Such new versions will be similar in spirit to the present version, but may differ in detail to address new problems or concerns. See <http://www.gnu.org/copyleft/>.

Each version of the License is given a distinguishing version number. If the Document specifies that a particular numbered version of this License “or any later version” applies to it, you have the option of following the terms and conditions either of that specified version or of any later version that has been published (not as a draft) by the Free Software Foundation. If the Document does not specify a version number of this License, you may choose any version ever published (not as a draft) by the Free Software Foundation.

.31 ADDENDUM: How to use this License for your documents

To use this License in a document you have written, include a copy of the License in the document and put the following copyright and license notices just after the title page:

Copyright (c) YEAR YOUR NAME. Permission is granted to copy, distribute and/or modify this document under the terms of the GNU Free Documentation License, Version 1.2 or any later version published by the Free Software Foundation; with no Invariant Sections, no Front-Cover Texts, and no Back-Cover Texts. A copy of the license is included in the section entitled “GNU Free Documentation License”.

If you have Invariant Sections, Front-Cover Texts and Back-Cover Texts, replace the “with...Texts.” line with this:

with the Invariant Sections being LIST THEIR TITLES, with the Front-Cover Texts being LIST, and with the Back-Cover Texts being LIST.

If you have Invariant Sections without Cover Texts, or some other combination of the three, merge those two alternatives to suit the situation.

If your document contains nontrivial examples of program code, we recommend releasing these examples in parallel under your choice of free software license, such as the GNU General Public License, to permit their use in free software.

Part XII

Eeek! There is Missing Help

Sorry, but a help item is missing for the function you're looking for. You may be able to find it in the online version of the help at the [GIMP docs](#) website.

Feel free to join us and fill the gap by writing documentation for GIMP. For more information, subscribe to our [Mailing list](#). Generally, it's a good idea to check the [GIMP project page](#).

Found a **content error** or just something which doesn't look right? [Report an error in the bug tracker](#) and let us know.

Index

-
- .gif, 60
- .jpeg, 61
- .jpg, 61
- .png, 952
- .psd, 953
- .xcf, 950, 956
- .xcf.gz, 956
- 3D Transform, 314
- 8-bit, 16-bit, 32-bit, 423
- A**
- Abyss Policy, 329
- Acquire, 426
- Add Alpha channel, 545
- Add Bevel, 810
- Add Border, 812
- Addition, 110
- Airbrush, 268
- Align, 295
- Align visible layers, 517
- Alpha, 546, 939
- Alpha Channel, 102
- Alpha channel, 939
- Anchor Layer, 534
- Animation
 - Animated GIF options, 61
 - Creating an animated brush, 84
 - Optimize, 925
 - Playback, 926
- Antialias, 659
- Antialiasing
 - Explanation, 939
 - Preserve anti-aliasing, 545
- Apply Layer Mask (command), 541
- Apply Lens, 678
- Assign Color Profile, 490
- B**
- Background color, 206
- Background layer, 102
- Basic Setup, 11
- Bayer Matrix, 875
- Behind (paint mode), 240
- Black point, 567
- Blend, 919
- Blur/Sharpen, 280
- BMP, 940
- Border, 459
- Border Average, 612
- bpp, 943
- Browser
 - Plug-In, 637
 - Procedure, 638
- Brush, Pattern, Gradient area
 - Preferences, 154
- Brushes, 373
- Add New, 83
- Animated brushes
 - Introduction, 82
- Changing brush size, 88
- Clipboard brush, 377
- Color, 82
- Dialog, 373
- File formats, 83
- Filter brush, 276
- History brush, 276
- Introduction, 81
- Ordinary, 81
- Parametric, 82
- Toolbox Indicator Area, 207
- Bucket Fill, 249
- Buffers
 - Copy named, 397
 - Cut named, 397
 - Dialog, 397
 - Named Buffers: Cut/Copy/Paste, 441
 - Paste named, 397
- Bugs, 993
- Bump Map, 827
- Burn, 112
- Burn-In, 920
- Button
 - Script-Fu-generated, 183
- Bézier's curve, 331
- C**
- Cage, 325
- Calibrate monitor, 157
- Canvas
 - effect, 775
 - Fit canvas size to layers, 511
 - Fit canvas size to selection, 511
 - Padding color, 477
 - Size, 507
 - Snap to canvas, 476
- Canvas effect, 775
- Cartoon, 777
- Cartoon (legacy), 789
- Chain icon, 104
- Channel, 10, 591, 942
 - Channel mask, 356
 - Channel to Selection, 354
 - Create a New Channel Mask, 354
 - Delete Channel Mask, 354
 - Dialog, 352
 - Duplicate Channel Mask, 354
 - Edit Channel Attributes, 354
 - Move Channel Mask, 354
- Channel encoding, 940
- Channel Mixer, 584
- Channels
 - Menu, 355
- Checkerboard, 877

- Checkerboard (legacy), 884
- CIE lch Noise, 740
- Circuit, 894
- Circular Motion Blur, 654
- Clear, 442
- Clip Warning, 474
- Clipboard Brush, 377
- Clipboard pattern, 380
- Clipping
 - Transform, 291
- Clone, 271
- Close, 434
- Clothify, 790
- CML Explorer, 885
- CMYK, 589, 591, 593, 942
- Coffee Stain, 813
- Color, 139, 942
 - Additive color model, 953
 - Adjust level colors, 567
 - Color Balance, 559
 - Color display, 471
 - Colorize, 619
 - Deficient vision, 472
 - Dithering, 944
 - Grab color, 334
 - HTML notation, 948
 - Indexed colors, 949
 - Merging layer Modes, 105
 - Padding color of canvas, 477
 - Palettes, 388
 - Palettes (color map), 95
 - Saturation, 955
 - Selection by color, 224
 - Subtractive color synthesis, 942
 - Value, 956
- Color Area, 206
- Color area
 - Preferences, 154
- Color Balance, 559
- Color depth, 943
- Color Enhance (legacy), 583
- Color Erase, 108
- Color Erase (paint mode), 240
- Color Exchange, 601
- Color Management, 145, 146, 474, 953
 - Assign Color Profile, 490
 - Convert to Color Profile, 496
 - Discard Color Profile, 503
 - Enable Color Management, 486
 - Save Color Profile to File, 504
 - Submenu, 485
- Color management, 140
- Color model, 943
- Color Picker, 334
- Color Profile, 145
- Color profile, 140
- Color Selector, 370
- Color Temperature, 561
- Color to Alpha, 545
- Colorcube Analysis, 613
- Colorize, 619
- Colormap, 362
 - Rearrange, 599
 - Set, 600
- Colors
 - Auto, 578
 - Border Average, 612
 - Color enhance (legacy), 583
 - Color Temperature, 561
 - Colorcube Analysis, 613
 - Components
 - Channel mixer, 584
 - Compose, 589
 - Decompose, 591
 - Extract Component, 587
 - Mono-mixer, 588
 - Recompose image from its components, 593
 - Desaturate
 - Desaturate, 593
 - Sepia, 597
 - Equalize, 580
 - Exchange colors, 601
 - Export Histogram, 614
 - Exposure, 564
 - Hot, 625
 - Hue-Chroma, 561
 - Invert, 576
 - Map
 - Gradient Map, 605
 - Palette Map, 606
 - Rotate, 602
 - Sample Colorize, 607
 - Saturation, 564
 - Shadows and Highlights, 565
 - Smooth Palette, 615
 - Stretch colors in HSV space, 582
 - Stretch contrast, 581
 - Stretching, 578
 - Tone Mapping
 - Retinex, 609
 - Value Invert, 577
 - White balance, 580
- Command line Arguments, 6
- Comment, 425
- Compose, 589, 591
- Composition guides, 216
- Concepts, 9
- Context menus, 419
- Contrast, 473, 581
- Convert to Color Profile, 496
- Convolution Matrix, 760
- Copy Image Location, 434
- Copy Named, 397
- Copy Visible, 438
- Copy Visible (Layers), 438
- Create Template, 433
- Crop, 303
- Crop Layer, 557

- Crop to content, 514, 557
- Crop to selection, 514
- CSS Keywords, 372
- Cubism, 778
- Curve Bend, 706
- Curves, 572
- Customize
 - Shortcuts, 173
 - Splash-screen, 175
- Cut, 437
- Cut Named, 397

- D**
- Darken only, 110
- Dashboard, 409
- Data folders
 - Preferences, 169
- Decompose, 591
- Decor, 810
- Deinterlace, 661
- Depth Merge, 770
- Desaturate, 593
- Despeckle, 671
- Destripe, 672
- Device Status, 407
- Diagonal Neighbors, 221
- Dialog
 - Sample Points, 412
 - Symmetry Painting, 414
- Dialogs
 - Brushes, 373
 - Buffers, 397
 - Channels, 352
 - Color Selector, 370
 - Colormap, 362
 - Device Status, 407
 - Docking, 19
 - Document History, 400
 - Fonts, 395
 - Gradient Dialog, 380
 - Histogram, 364
 - Images, 399
 - Introduction, 347
 - Layers, 347
 - Palettes, 388
 - Paths, 358
 - Patterns, 378
 - Pointer, 413
 - Preferences, 143
 - Color Management, 145
 - Data folders, 169
 - Display, 157
 - Folders, 168
 - Help System, 156
 - Image Windows, 160, 161
 - Interface, 152
 - Title and Statusbar, 163
 - Tool Options, 149
 - Toolbox, 154
 - Window management, 158
 - Templates, 401
 - Undo History, 368
- Difference, 115
- Difference Clouds, 874
- Difference of Gaussians, 750
- Differential, 751
- Diffraction patterns (filter), 878
- Dilate, 769
- Disable Layer Mask, 542
- Discard Color Profile, 503
- Displace, 830
- Display
 - Dot for Dot, 467
 - Full Screen, 470
 - Preferences, 157
- Display-referred, 943
- Display-referred black, 944
- Display-referred white, 944
- Dissolve, 107
- Distance Map, 763
- Distort Selection, 462
- Dithering, 944
- Divide, 117
- Docking, 19
- Docks
 - Add Tab, 22
 - Add tab, 865
 - Close tab, 22
 - Context Menu, 22
 - Detach tab, 22
 - Lock tab, 23
 - Preview size, 23
 - Tab menu, 21
 - Tab style, 23
 - View as List/Grid, 23
- Document History, 400
- Dodge, 109
- Dodge/Burn, 287
- Dot for Dot, 467
- Dot for dot, 160
- Draw, 40
- Drawable, 101
- Drop Shadow, 727
- Drop Shadow (legacy), 734
- Duplicate, 479
- Duplicate Layer, 534
- Dynamics, 241
- Dynamics Matrix, 243
- Dynamics Options, 248

- E**
- Edge, 751
- Edge feathering (Selections), 212
- Edge-Detect, 749
- Edit Layer Mask, 542
- Edit Template, 402
- Editor, 453
- Ellipse Selection Tool, 216

- Emboss, 679
- Emboss (legacy), 708
- Enable Color Management, 486
- Engrave, 681
- Equalize, 580
- Erase, 108
- Eraser, 266
- Erode, 770
- Error console, 407
- Exclusion, 115
- EXIF, 944
- Export, 432
- Export As, 433
- Export File, 410
- Export Histogram, 614
- Export Image as GIF, 60
- Export Image as JPEG, 61
- Export Image as MNG, 67
- Export Image as PNG, 64
- Export Image as TIFF, 65
- Export Images, 59
- Exposure, 564
- Extract Component, 587
- Eye Dropper, 334

- F**
- Feathering, 944
- File
 - New image, 55
- File format, 945
- Files, 59
 - Open, 55
- Fill Path, 444
- Fill Selection Outline, 443
- Fill with Background color, 442
- Fill with Foreground Color, 442
- Fill with Pattern, 443
- Filmstrip, 773
- Filters
 - Add Bevel, 810
 - Add Border, 812
 - Animation
 - Blend, 919
 - Burn-In, 920
 - Introduction, 919
 - Optimize, 925
 - Playback, 926
 - Rippling, 922
 - Spinning Globe, 923
 - Waves, 924
 - Artistic
 - Canvas effect, 775
 - Cartoon, 777
 - Cartoon (legacy), 789
 - Clothify, 790
 - Cubism, 778
 - GIMPressionist, 791, 798, 799
 - Glass Tile, 780
 - Introduction, 775
 - Oilify, 781
 - Oilify (legacy), 801
 - Photocopy, 783
 - Predator, 803
 - Simple Linear Iterative Clustering, 784
 - Softglow, 786
 - Softglow (legacy), 804
 - Van Gogh, 805
 - Waterpixels, 787
 - Weave, 808
- Blur, 643
 - Circular Motion, 654
 - Gaussian Blur, 645
 - Linear Motion, 655
 - Mean Curvature Blur, 646
 - Median Blur, 649
 - Pixelize, 652
 - Selective Gaussian, 653
 - Tileable Blur, 658
 - Zoom Motion, 656
- Combine
 - Depth Merge, 770
 - Filmstrip, 773
 - Introduction, 770
- Common functions
 - Introduction to filters, 627
 - Re-show last, 628
 - Repeat Last, 627
 - Reset all, 628
- Decor
 - Coffee Stain, 813
 - Fuzzy Border, 815
 - Introduction, 810
 - Old Photo, 817
 - Round Corners, 819
 - Slide, 821
 - Stencil Carve, 822
 - Stencil Chrome, 824
- Distorts
 - Curve Bend, 706
 - Emboss, 679
 - Emboss (legacy), 708
 - Engrave, 681
 - Introduction, 677
 - Lens Distortion, 682
 - Mosaic, 685
 - Newsprint, 709
 - Page Curl, 711
 - Polar Coordinates, 687
 - Ripple, 689
 - Shift, 692
 - Video Degradation, 699
 - Whirl and Pinch, 702
 - Wind, 704
- Drop Shadow, 727
- Edge Detect
 - Difference of Gaussians, 750
 - Edge, 751
 - Image Gradient, 757

- Introduction, 749
- Laplace, 754
- Neon, 755
- Sobel, 756
- Enhance
 - Antialias, 659
 - Deinterlace, 661
 - Despeckle, 671
 - Destripe, 672
 - High Pass, 662
 - Introduction, 659
 - NL filter, 673
 - Noise Reduction, 664
 - Red Eye Removal, 667
 - Sharpen (Unsharp Mask), 668
 - Symmetric Nearest Neighbor, 667
 - Wavelet-decompose, 675
- Generic
 - Convolution Matrix, 760
 - Dilate, 769
 - Distance Map, 763
 - Erode, 770
 - GEGL graph, 765
 - Introduction, 759
 - Normal Map, 766
- Introduction, 641
- Light and Shadow, 713
 - Apply Lens, 678
 - Drop Shadow (legacy), 734
 - Gradient Flare, 716
 - Lens Flare, 715
 - Lighting effects, 721
 - Perspective, 735
 - Sparkle, 725
 - Supernova, 713
 - Xach-Effect, 738
- Long Shadow, 729
- Map
 - bump-map, 827
 - Displace, 830
 - Fractal Trace, 836
 - Fractal Trace (legacy), 849
 - Illusion, 837
 - Introduction, 827
 - Little Planet, 838
 - Map Object, 850
 - Panorama Projection, 841
 - Paper Tile, 846
 - Recursive Transform, 843
 - Tile, 854
 - Tile Seamless, 848
- Menu, 627
- Noise
 - CIE lch, 740
 - HSV Noise, 741
 - Hurl, 742
 - Introduction, 739
 - Pick, 743
 - RGB Noise, 745
 - Slur, 746
 - Spread, 748
- Render
 - Bayer Matrix, 875
 - Cell Noise, 867
 - Checkerboard, 877
 - Checkerboard (legacy), 884
 - Circuit, 894
 - CML Explorer, 885
 - Difference Clouds, 874
 - Diffraction, 878
 - Flame, 855
 - Fog, 814
 - Fractal Composition, 863
 - Fractal Explorer, 859
 - Gfig, 896
 - Grid, 879
 - Grid (legacy), 890
 - Introduction, 855
 - Jigsaw, 892
 - Lava, 899
 - Line Nova, 900
 - Maze, 881
 - Perlin Noise, 868
 - Plasma, 870
 - Random textures, 893
 - Simplex Noise, 871
 - Sinusoidal textures, 882
 - Solid Noise, 872
 - Sphere Designer, 902
 - Spyrogimp, 904
- Vignette, 731
- Web
 - Clickable image, 910
 - Introduction, 910
 - Semi-Flatten, 915
 - Slice, 916
- filters
 - Distorts, 693
- Fit canvas to layers, 511
- Fit canvas to selection, 511
- Flame, 855
- Flatten, 517
- Flip, 324, 507
- Flip and Rotate, 469
- Flip horizontally (layer), 550
- Flip vertically (layer), 550
- Floyd-Steinberg, 945
- Fog, 814
- Fonts
 - Add, 128
 - Dialog, 395
 - Problems, 130
- Foreground color, 206
- Foreground Select, 228
- Formats
 - BMP, 940
 - GBR, 83
 - GIF, 60

- GIH, 83
- JPEG, 61
- MNG, 67
- MYB, 83
- PDF, 952
- PNG, 64
- PostScript, 953
- PSD, 953
- SVG, 955
- TGA, 955
- TIFF, 65
- VBR, 83
- XCF, 956
- Fractal Explorer, 859
- Fractal trace, 836
- Fractal trace (legacy), 849
- Full Screen, 470
- Fuzzy Border, 815
- Fuzzy Selection, 221
- G**
- Gamma, 473, 567, 945
- Gamut, 946
- Gaussian Blur, 645
- GBR, 83
- GEGL graph, 765
- GEGL operation, 345
- Gfig, 896
- GIF, 60, 946
- GIH, 83
- GIMP
 - Bugs, 993
 - Getting Unstuck, 47
 - History, 967
 - How to contribute, 997
 - Introduction, 3
- GIMP Online, 639
- GIMPpressionist, 791, 798, 799
- Glass Tile, 780
- Glossary, 939
- Gradient, 253, 751
 - Dialog, 380
 - Editor, 383
 - From palette, 391
 - New gradient, 387
 - Overview, 91
 - Tool, 253
 - Toolbox Indicator Area, 207
- Gradient CSS code snippet, 382
- Gradient Flare, 716
- Gradient Map, 605
- Grain extract, 116
- Grain merge, 116
- Grayscale
 - Convert to grayscale, 480
 - Overview, 947
- Grid
 - Cell Noise, 867
 - configure, 523
 - Default setting, 151
 - Grid (legacy) filter, 890
 - Grid filter, 879
 - Overview, 169
 - Perlin Noise, 868
 - Show/Mask Grid, 476
 - Simplex Noise, 871
 - Snap to Grid, 476
- Guide
 - Add, 521
 - Add by percent, 522
 - Move, 303
- Guides, 521
 - Add from selection, 522
 - Overview, 169
 - Remove, 523
 - Selection guides, 216
 - Show/Mask Guides, 475
 - Snap to Guides, 476
 - Transform, 294
 - Using, 947
- H**
- Handle Transform, 320
- Hard light, 114
- Hard mix, 114
- Heal, 276
- HEIF/HEIC, 61
- Help, 156, 635
 - Context help, 635
 - Menu, 634
 - Online, 639
 - Overview, 636
 - Tip of the Day, 635
- High Dynamic Range, 947
- High Pass, 662
- Histogram, 364, 947
- Hot, 625
- HSL Color, 118
- HSV, 589, 591, 593
- HSV Hue, 118
- HSV Noise, 741
- HSV Saturation, 118
- HSV Value, 118
- HTML notation, 948
- Hue-Chroma, 561
- Hue-Saturation, 562
- Hurl, 742
- I**
- ICC profile, 139
- Icon Theme, 153
- IFS Fractal, 863
- Illusion, 837
- Image, 399
 - Acquire an image, 426
 - Active Image Thumbnail, 154
 - Canvas size, 507
 - change Mode, 34

- Close image, [434](#)
- Color Management
 - Assign Color Profile, [490](#)
 - Convert to Color Profile, [496](#)
 - Discard Color Profile, [503](#)
 - Enable Color Management, [486](#)
 - Menu, [485](#)
 - Save Color Profile to File, [504](#)
- Color modes
 - Menu, [480](#)
- Comment, [425](#)
- Convert
 - To grayscale, [480](#)
 - To indexed mode, [481](#)
 - To RGB mode, [480](#)
- Crop
 - According to color, [515](#)
 - To content, [514](#)
 - To selection, [514](#)
 - Tool, [303](#)
- crop, [32](#)
- Cut off image according to guides, [515](#)
- Export As, [433](#)
- Flip, [36](#)
- Grid and guides, [169](#)
- Guides, [521](#)
- Image size
 - When creating, [422](#)
- information, [33](#)
- Metadata, [526](#)
- New, [421](#)
- Open, [428](#)
 - As layers, [429](#)
 - Open location, [429](#)
 - Open recent, [430](#)
- Paste as, [440](#)
- Paths, [77](#)
- Precision, [483](#)
- Preferences
 - Default image, [150](#)
- Print size, [511](#)
- Reload the image, [432](#)
- Resize after zooming or scaling, [160](#)
- Resolution
 - Setting when creating, [423](#)
- Rotate, [38](#)
- save, [29](#)
- Save image
 - Save, [409](#)
 - Save a copy, [432](#)
 - Save as, [430](#)
- Scale, [26](#)
- scale, [28](#)
- Text, [128](#)
- Transform, [506](#)
- Image Gradient, [757](#)
- Image Hose, [948](#)
- Image hoses, [82](#)
- Image Import and Export, [148](#)
- Image Properties, [524](#)
- Image size, [160](#), [422](#)
- Image window
 - Menus, [465](#), [479](#), [558](#)
- Image Windows
 - Basic settings, [158](#)
 - Preferences, [160](#), [161](#)
- Image windows
 - Description, [16](#)
- ImageMap, [910](#)
- Images
 - Types, [53](#)
- Incremental, [948](#)
- Indent, [342](#)
- Indexed Colors, [949](#)
- Indexed colors, [481](#)
- Indexed palette, [95](#)
- Ink, [270](#)
- Input Controllers, [165](#)
- Input Devices, [164](#)
- Interface
 - Preferences, [152](#)
- Invert colors, [576](#)
- IPTC, [949](#)

- J**
 - Jigsaw, [892](#)
 - Jitter, [237](#)
 - JPEG, [61](#), [949](#)
 - Justify, [342](#)

- K**
 - Keyboard Shortcuts, [152](#), [447](#)

- L**
 - Languages, [5](#), [152](#)
 - Laplace, [751](#), [754](#)
 - Lasso, [219](#)
 - Lava, [899](#)
 - Layer, [591](#), [949](#)
 - Activate, [104](#)
 - Anchor the floating layer, [534](#)
 - Boundaries, [104](#)
 - Clear
 - Clear layer content, [442](#)
 - Copy, [438](#)
 - Copy visible layers, [438](#)
 - Creating new layers, [118](#)
 - Cut (/Paste)
 - Cut layer content, [437](#)
 - Dialog, [347](#)
 - Fill
 - Fill with background color, [442](#)
 - Fill with foreground color, [442](#)
 - Fill with pattern, [443](#)
 - Mask managing
 - Add a mask, [540](#)
 - Add layer mask to selection, [543](#)
 - Apply, [541](#)

- Convert layer mask to a selection, 542
- Delete layer mask, 541
- Disable, 542
- Edit, 542
- Intersect layer mask with selection, 544
- Show layer mask, 541
- Subtract layer mask from selection, 543
- Modes, 105
- Move, 303
- On-canvas layer selection, 119
- Paste, 438, 440, 441
- Preview size, 23
- Scale, 308
- Size, 104
- Size managing
 - Crop according to selection, 557
 - Crop to content, 557
 - Resize current layer and its content, 556
 - Resize current layer but not its content, 554
 - Resize current layer to image size, 556
- Stack managing
 - Align visible layers, 517
 - Bottom layer, 538
 - Create a new layer, 529
 - Create a new layer from visible layers, 534
 - Delete current layer, 535
 - Layer duplicate, 534
 - Lower current layer to the bottom of stack, 539
 - Lower layer, 538
 - Merge current layer with the underlying layer, 535
 - Merge visible layers, 516
 - Move current layer one position up, 538
 - Move current layer to the top of stack, 539
 - Next layer, 537
 - Open image as layers, 429
 - Previous layer, 537
 - Reverse layer order, 539
 - Select top layer, 538
- Sub-menu
 - Mask, 539
 - Stack, 536
 - Transform, 549
 - Transparency, 544
- Text, 536
- Transform
 - Flip horizontally, 550
 - Flip vertically, 550
 - Rotation, 551, 552
 - Shift layer content, 552
- Transparency managing
 - Add Alpha channel to background layer, 545
 - Add non-transparent areas to selection, 547
 - Intersect non-transparent areas with selection, 548
 - Make colors transparent, 545
 - Preserve anti-aliasing, 545
 - Remove Alpha Channel, 545
 - Selection according to opacity, 547
 - Subtract non-transparent pixels from selection, 548
 - Threshold, 546
 - Type, 103
- Layer boundary
 - Show / mask layer boundary, 475
- Layer Boundary Size, 554
- Layer Group
 - New, 533
- Layer groups, 119
- Layer mask, 351
- Layer Modes
 - Addition, 110
 - Burn, 112
 - Color Erase, 108
 - Darken only, 110
 - Difference, 115
 - Dissolve, 107
 - Divide, 117
 - Dodge, 109
 - Erase, 108
 - Exclusion, 115
 - Grain extract, 116
 - Grain merge, 116
 - Hard light, 114
 - Hard mix, 114
 - HSL Color, 118
 - HSV Hue, 118
 - HSV Saturation, 118
 - HSV Value, 118
 - LCh Chroma, 118
 - LCh Color, 118
 - LCh Hue, 118
 - LCh Lightness, 118
 - Lighten only, 108
 - Linear burn, 112
 - Linear light, 114
 - Luma/Luminance darken only, 111
 - Luma/Luminance lighten only, 109
 - Luminance, 118
 - Merge, 108
 - Multiply, 111
 - Normal, 107
 - Overlay, 112
 - Pin light, 114
 - Screen, 109
 - Soft light, 113
 - Split, 108
 - Subtract, 115
 - Vivid light, 114
- Layers, 101
 - Linkage, 104
 - Merge all layers, 517
- LCh Chroma, 118
- LCh Color, 118
- LCh Hue, 118
- LCh Lightness, 118
- LCh Luminance, 118

- Lens Distortion, 682
- Lens Flare, 715
- Levels tool, 567
- Lighten only, 108
- Lighting effects, 721
- Line
 - Drawing a straight line, 97
- Line Nova, 900
- Line spacing, 342
- Linear burn, 112
- Linear light, 114
- Linear Motion Blur, 655
- List search field, 23
- Little Planet, 838
- Lock alpha channel, 348
- Lock pixels, 348
- Logo
 - Script-Fu-generated, 183
- Long Shadow, 729
- Luma/luminance darken only, 111
- Luma/luminance lighten only, 109

- M**
- Magic Wand, 221
- Map Object, 850
- Marching ants speed, 160
- Masks
 - Channel mask, 356
 - Layer mask, 351
 - Add, 540
 - Add to selection, 543
 - Apply, 541
 - Convert to a selection, 542
 - Delete, 541
 - Disable, 542
 - Edit, 542
 - Intersect with selection, 544
 - Overview, 105
 - Show, 541
 - Subtract from selection, 543
 - Overview, 950
 - Quick Mask
 - Using Quick Mask, 77
 - Quick mask, 356
 - Selection mask, 356
- Maze, 881
- Mean Curvature Blur, 646
- Measure, 337
- Measure a distance, 337
- Measure a surface, 337
- Measure an angle, 337
- Median Blur, 649
- Menu
 - File, 421
 - Help, 634
- Menu-bar
 - Show/Mask menu bar, 477
- Menus
 - Edit, 436
 - File menu, 421
 - Filters, 627
 - Image, 479
 - Introduction, 419
 - Layer, 528
 - Selection, 450
 - Tools, 626
 - Windows, 633
- Merge, 108
- Merge Down, 535
- Merge Visible Layers, 516
- Metadata, 526
 - Metadata Editor, 527
 - Metadata Viewer, 527
- MNG, 67
- Modes (color)
 - Grayscale, 480
 - Indexed, 481
 - RGB, 480
- Modes (Colors)
 - Submenu, 480
- Modes of layers, 105
- Module Manager, 447
- Modules, 447
- Moiré, 950
- Mono-mixer, 588
- Mosaic, 685
- Mouse cursors, 161
- Mouse Scroll-Wheel, 210
- Move, 301
- Multiply, 111
- MYB, 83
- MyPaint Brush, 263

- N**
- Navigation
 - Dialog, 367
 - Navigation button, 19
 - Preview size, 152
 - View Navigation window, 471
- Navigation preview, 16
- Neon, 755
- New, 421
- New Image, 421
- New image
 - Default setting, 150
- New instance, 6
- New Layer, 529
- New View, 465
- Newsprint, 709
- NL filter, 673
- Noise Reduction, 664
- Nonlinear filter, 673
- Normal Map, 766

- O**
- Offset, 552
- Oilify, 781
- Oilify (legacy), 801

- Old Photo, [817](#)
- Opacity
 - Brush, [235](#)
 - Layers dialog, [348](#)
- Open, [428](#)
- Open as layers, [429](#)
- Open Location, [429](#)
- Open Recent, [430](#)
- Overlay, [112](#)
- P**
- Padding color, [477](#)
- Page Curl, [711](#)
- Paint Modes
 - Behind, [240](#)
 - Color Erase, [240](#)
- Paint Tools, [233](#)
- Paintbrush, [261](#)
- Palette
 - Delete, [389](#)
 - Dialog, [388](#)
 - Duplicate, [389](#)
 - Editor, [392](#)
 - Import, [389](#)
 - Introduction, [95](#)
 - Menu, [389](#)
 - New palette, [389](#)
 - Refresh, [389](#)
- Palette Color Selector, [371](#)
- Palette Map, [606](#)
- Panorama Projection, [841](#)
- Paper Tile, [846](#)
- Parasite, [950](#)
- Pass Through, [119](#)
- Paste, [438](#)
- Paste as new brush, [440](#)
- Paste as New Layer, [440](#)
- Paste as New Layer in Place, [440](#)
- Paste as new pattern, [441](#)
- Paste In Place, [439](#)
- Paste Into Selection, [439](#)
- Paste Into Selection In Place, [439](#)
- Paste Named, [397](#)
- Path
 - Move, [303](#)
 - Scale, [308](#)
 - Snap to active path, [477](#)
- Paths
 - Dialog, [358](#)
 - Stroke, [445](#)
 - Tool, [331](#)
 - Transform, [294](#)
 - Using, [77](#)
- Patterns
 - Add a pattern to layer, [855](#)
 - Clipboard pattern, [380](#)
 - Clone, [273](#)
 - Dialog, [378](#)
 - Introduction, [93](#)
 - Script-Fu-generated, [182](#)
 - Toolbox Indicator Area, [207](#)
- PDF, [952](#)
- Pencil, [260](#)
- Perspective, [312](#), [735](#)
- Perspective Clone, [278](#)
- Photocopy, [783](#)
- Photography, [131](#)
- Pick, [743](#)
- Pin light, [114](#)
- Pixel, [952](#)
- Pixelize, [652](#)
- Plasma, [870](#)
- Playback, [926](#)
- Plugins
 - Browser, [637](#)
 - Definition, [952](#)
 - Install, [178](#)
 - Introduction, [177](#)
 - Write, [179](#)
- PNG, [64](#), [952](#)
- Pointer, [413](#)
- Polar Coordinates, [687](#)
- Polygonal Selection, [219](#)
- Portrait/Landscape mode, [423](#)
- Posterize, [620](#)
- Precision, [423](#), [483](#)
- Predator, [803](#)
- Preferences, [143](#)
 - Dialog defaults, [155](#)
 - Icon Theme, [153](#)
 - Image grid, [151](#)
 - Input Controllers, [165](#)
 - Input Devices, [164](#)
 - Snapping, [164](#)
 - Theme, [153](#)
- Preferences (command), [447](#)
- Presets
 - Introduction, [97](#)
 - Presets Dialog, [404](#)
 - Tool Preset Editor, [406](#)
- Preview
 - Composited preview, [292](#)
 - Filter, [641](#)
 - Navigation preview, [16](#)
 - Navigation preview size, [152](#)
 - Transformation tools, [292](#)
- Previews, [152](#)
 - Tab preview size, [23](#)
- Prewitt compass, [751](#)
- Print Size, [511](#)
- Printing
 - Print command, [434](#)
 - Printing your photos, [137](#)
 - Size and resolution, [511](#)
- Procedure
 - Browser, [638](#)
- PSD, [953](#)
- Python-Fu

- Sub-menu, 629
- Q**
- Qbist, 893
- Quantization, 953
- QuickMask, 75
- Quit GIMP, 435
- R**
- Re-show Last, 628
- Rearrange Colormap, 599
- Recompose, 593
- Rectangle
 - Drawing a rectangle, 97
- Recursive Transform, 843
- Red Eye Removal, 667
- Red-eyes, 136
- Redo, 437
- Remove Alpha channel, 545
- Remove Holes, 460
- Repeat Last, 627
- Reset All, 628
- Resolution, 10
 - Printing, 511
 - Setting when creating, 423
- Retinex, 609
- Revert (command), 432
- RGB, 480, 589, 591, 593, 953
- RGB Noise, 745
- Ripple filter, 689
- Rippling, 922
- Roberts, 751
- Rotate, 306, 552
- Rotate 180°, 551
- Rotate 90° clockwise, 551
- Rotate 90° counter-clockwise, 551
- Rotate Colors, 602
- Rotation, 507
- Round Corners, 819
- Rounded rectangle, 463
- Rulers
 - Show/Mask rulers, 478
- Running GIMP, 5
- S**
- Sample Colorize, 607
- Sample Points, 412, 476
- Saturation, 564, 955
- Save, 409
- Save a copy, 432
- Save as, 430
- Save Color Profile to File, 504
- Save/Export Images, 59
- Scale Image, 512
- Scale layer, 556
- Scale Layer, selection contour or path, 308
- Scene-referred, 955
- Scissors tool, 226
- Screen, 109
- Screenshot, 427
- Script-Fu
 - Button, 183
 - Install, 180
 - Introduction, 180
 - Logo, 183
 - Standalone, 182
 - Sub-menu, 631
 - Tutorial, 183
- Scroll-bars
 - Show/Mask scrollbars, 478
- Selection
 - According to opacity, 547
 - Add / Subtract selections, 75
 - Add alpha channel, 547
 - Add layer mask to selection, 543
 - By Color select, 453
 - Change shape, 268
 - Clear selection content, 442
 - Copy, 438
 - Create a selection border, 459
 - Create a selection from Path, 453
 - Cut selection content, 437
 - Delete selections, 451
 - Distort, 462
 - Editor, 453
 - Ellipse selection, 216
 - Feather selection edges, 456
 - Fill
 - Fill with background color, 442
 - Fill with foreground color, 442
 - Fill with pattern, 443
 - Floating selection, 945
 - Floating selection (command), 452
 - Foreground Select, 228
 - Free Selection, 219
 - Fuzzy selection, 221
 - Grow, 458
 - Intersect with Alpha channel, 548
 - Invert selection, 451
 - Modes, 212
 - Move selection, 73
 - Paste, 438, 440, 441
 - Paste In Place, 439
 - Paste Into Selection, 439
 - Paste Into Selection In Place, 439
 - Polygonal Selection, 219
 - Rectangle selection, 212
 - Remove Holes, 460
 - Remove the feathering of border selection, 457
 - Rounded Rectangle, 463
 - Save selection to channel, 464
 - Scale, 308
 - Select All, 451
 - Selection boundary
 - Show/Mask selection boundary, 475
 - Selection by color, 224
 - Selection mask, 356
 - Selection to Path

- Advanced options, 455
- Shrink the size of selection, 457
- Stroke selection, 444
- Subtract non-transparent pixels, 548
- Toggle QuickMask, 464
- Transform selection to path, 464
- Selections
 - Common Features, 210
 - Concepts, 71
 - Using, 73
- Selective Gaussian Blur, 653
- Semi-Flatten, 915
- Send by Email, 434
- Sepia, 597
- Set Colormap, 600
- Setup, 7
- Shadows and Highlights, 565
- Sharpen (Unsharp mask), 668
- Shear, 310
- Shift, 692
- Shortcuts, 173
- Show All, 466
- Show Grid, 476
- Show Guides, 475
- Show in File Manager, 434
- Show Layer Boundary, 475
- Show Layer Mask (command), 541
- Show Menubar, 477
- Show Rulers, 478
- Show Scrollbars, 478
- Show Selection, 475
- Show Statusbar, 478
- Shrink Wrap, 470
- Simple Linear Iterative Clustering, 784
- Sinus, 882
- Slice, 916
- Slice Using Guides, 515
- Slide, 821
- Sliders, 209
- Slur, 746
- Smooth Palette, 615
- Smudge, 283
- Snap to active path, 477
- Snap to canvas, 476
- Snap to Grid, 476
- Snap to Guides, 476
- Snapping, 164
- Sobel, 751, 756
- Soft light, 113
- Softglow, 786
- Softglow (legacy), 804
- Solid noise, 872
- Space bar, 160, 301
- Sparkle, 725
- Sphere Designer, 902
- Spherize, 693
- Spinning Globe, 923
- Splash-screen, 175
- Split, 108
- Spread, 748
- Spyrogimp, 904
- Stack, 536
- Status bar
 - Image window, 16
 - Preferences, 163
 - Show/Hide status bar, 478
- Stencil Carve, 822
- Stencil Chrome, 824
- Stoke path, 445
- Straight Line, 234
- Straighten, 337
- Stretch Contrast, 581
- Stretch HSV, 582
- Stroke Selection, 444
- Subtract, 115
- Supernova, 713
- Supersampling, 955
- SVG, 955
- Swap folder, 168
- Symmetric Nearest Neighbor, 667
- Symmetry Painting, 414
- System Resources, 144
- T
 - Tab menus, 420
 - Tags, 394
 - TARGA, 955
 - Tear-off line, 419
 - Tear-off menus, 419
 - Temp folder, 168
 - Template
 - Create Template, 433
 - Edit, 402
 - Menu, 422
 - Templates, 401
 - Text
 - Context Menu, 126
 - Discard information, 536
 - Editing text, 123
 - Editor, 343
 - Embellishing text, 128
 - Fonts, 128
 - Load from file, 344
 - Managing Text Layer, 124
 - Move, 303
 - Text Area, 123
 - Text Toolbox, 125
 - Tool, 340
 - Text along Path, 127
 - Text to Selection, 535
 - TGA, 955
 - Theme, 153
 - Threshold, 615
 - TIFF, 65, 955
 - Tile, 854
 - Tile cache, 172
 - Tile Seamless, 848
 - Tileable Blur, 658

- Tip of the Day, 635
- Title bar
 - Preferences, 163
- Toolbox, 205
 - Active image area, 207
 - Color Area, 206
 - Configuration, 155
 - Indicator Area, 207
 - Introduction, 14
 - Paint Tools, 233
 - Preferences, 154
- Tools
 - 3D Transform, 314
 - Airbrush, 268
 - Align, 295
 - Blur/Sharpen, 280
 - Brightness-Contrast, 566
 - Brush, 249
 - Bucket Fill, 249
 - Cage Tool, 325
 - Clone, 271
 - Color Picker, 334
 - Crop, 303
 - Curves, 572
 - Dodge/Burn, 287
 - Dynamics, 241
 - Dynamics Matrix, 243
 - Dynamics Options, 248
 - Ellipse Selection, 216
 - Eraser, 266
 - Flip, 324
 - Foreground Select, 228
 - Free Selection, 219
 - Fuzzy Selection, 221
 - GEGL operation, 345
 - Gradient, 253
 - Handle Transform, 320
 - Heal, 276
 - Ink, 270
 - Levels, 567
 - Measure, 337
 - Miscellaneous, 330
 - Move, 301
 - MyPaint Brush, 263
 - Paint, 233, 249
 - Paintbrush, 261
 - Path, 331
 - Pencil, 260
 - Perspective, 312
 - Perspective Clone, 278
 - Posterize, 620
 - Preferences, 149
 - Rectangle Selection, 212
 - Rotate, 306
 - Scale, 308
 - Scissors, 226
 - Selection by color, 224
 - Shear, 310
 - Smudge, 283
 - Text, 340
 - Threshold, 615
 - Tool groups, 205
 - Transform Tools, 289
 - Unified Transform, 315
 - Warp Transform, 327
 - Zoom, 336
- Transform, 506
 - Clipping, 291
 - Guides, 294
 - Paths, 294
- Transparency
 - Alpha channel, 939
 - Background layer transparency, 102
 - Brush opacity, 235
 - Eraser tool, 266
 - Exporting images with transparency, 69
 - Keep Layer Transparency, 348
 - Layer opacity, 348
 - Lock Alpha channel, 348
 - Representation, 157
- Triangle Color Selector, 371
- Tutorial, 26, 28, 29, 32–34, 36, 38–40
- Tutorials
 - Create image, 55
 - Drawing a rectangle, 97
 - Drawing a straight line, 97
 - New gradient, 387
- U
 - Undo, 25, 436
 - Undo History, 368, 437
 - Unified Transform, 315
 - Unit Editor, 448
 - Unit of measurement, 448
 - Units, 448
 - URI, 956
 - URL, 956
- Using
 - Preferences
 - Image Import and Export, 148
 - System Resources, 144
- V
 - Value, 956
 - Value Invert, 577
 - Value Propagate, 696
 - Values, 567
 - Van Gogh (LIC), 805
 - VBR, 83
 - Video Degradation, 699
- View
 - Introduction, 465
 - Padding color of canvas, 477
- Vignette, 731
- Visibility
 - Icon, 104
- Vivid light, 114
- Voronoi, 799

W

Warp Transform, 327

Watercolor Color Selector, 371

Waterpixels, 787

Wavelet-decompose, 675

Waves, 700, 924

Weave, 808

Web

 Images for the web, 67

Whirl and Pinch, 702

White Balance, 580

White point, 567

Wind, 704

X

Xach-Effect, 738

XCF, 950, 956

XDS, 15

XMP, 956

Y

YCbCr, 589, 591, 593, 956

YUV, 589, 591, 593, 957

Z

Zealous Crop, 515

Zoom, 160, 336, 468

Zoom Motion Blur, 656